

GaAlAs-Lumineszenzdioden (880 nm)

GaAlAs Infrared Emitters (880 nm)

SFH 480, SFH 481, SFH 482



SFH 480



SFH 481



SFH 482

Wesentliche Merkmale

- Hergestellt im Schmelzepitaxieverfahren
- Anode galvanisch mit dem Gehäuseboden verbunden
- Hohe Zuverlässigkeit
- Gute spektrale Anpassung an Si-Fotoempfänger
- Hermetisch dichtes Metallgehäuse
- SFH 480: Gehäusegleich mit SFH 216
- SFH 481: Gehäusegleich mit BPX 43
- SFH 482: Gehäusegleich mit BPX 38, BPX 65

Anwendungen

- Lichtschranken für Gleich- und Wechsellichtbetrieb
- IR-Gerätefernsteuerungen
- Sensorik
- Lichtgitter

Features

- GaAlAs infrared emitting diode, fabricated in a liquid phase epitaxy process
- Anode is electrically connected to the case
- High reliability
- Matches all Si-Photodetectors
- Hermetically sealed package
- SFH 480: Same package as SFH 216
- SFH 481: Same package as BPX 43
- SFH 482: Same package as BPX 38, BPX 65

Applications

- Photointerrupters
- IR remote control of various equipment
- Sensor technology
- Light-grille barrier

SFH 480, SFH 481, SFH 482

Typ Type	Bestellnummer Ordering Code	Gehäuse Package
SFH 480	Q62703-Q1087	18 A3 DIN 41876 (TO-18), Anschlüsse im 2.54-mm-Raster ($\frac{1}{10}$ "), Kathodenkennzeichnung: Nase am Gehäuseboden 18 A3 DIN 41876 (TO-18), lead spacing 2.54 mm ($\frac{1}{10}$ "), cathode marking: projection at package
SFH 480-2/3	Q62703-Q5195	
SFH 481	Q62703-Q1088	
SFH 481-1/2	Q62703-Q4752	
SFH 481-2/3	Q62703-Q4753	
SFH 482	Q62703-Q1089	
SFH 482-1/2	Q62703-Q4771	
SFH 482-2/3	Q62703-Q4754	
SFH 482-M E7800	Q62703-Q2186	

Grenzwerte ($T_C = 25\text{ °C}$)**Maximum Ratings**

Bezeichnung Parameter	Symbol Symbol	Wert Value	Einheit Unit
Betriebs- und Lagertemperatur Operating and storage temperature range SFH 480, SFH 482	$T_{op}; T_{stg}$	- 40 ... + 125	°C
Betriebs- und Lagertemperatur Operating and storage temperature range SFH 481	$T_{op}; T_{stg}$	- 40 ... + 100	°C
Sperrschichttemperatur Junction temperature	T_j	100	°C
Sperrspannung Reverse voltage	V_R	5	V
Durchlaßstrom Forward current	I_F	200	mA
Stoßstrom, $t_p = 10\ \mu\text{s}$, $D = 0$ Surge current	I_{FSM}	2.5	A
Verlustleistung Power dissipation	P_{tot}	470	mW
Wärmewiderstand Thermal resistance	R_{thJA} R_{thJC}	450 160	K/W K/W

Kennwerte ($T_A = 25\text{ °C}$)**Characteristics**

Bezeichnung Parameter	Symbol Symbol	Wert Value	Einheit Unit
Wellenlänge der Strahlung Wavelength at peak emission $I_F = 100\text{ mA}$	λ_{peak}	880	nm
Spektrale Bandbreite bei 50% von I_{max} Spectral bandwidth at 50% of I_{max} $I_F = 100\text{ mA}$	$\Delta\lambda$	80	nm
Abstrahlwinkel Half angle SFH 480 SFH 481 SFH 482	φ φ φ	± 6 ± 15 ± 30	Grad deg.

Kennwerte ($T_A = 25\text{ °C}$)**Characteristics** (cont'd)

Bezeichnung Parameter	Symbol Symbol	Wert Value	Einheit Unit
Aktive Chipfläche Active chip area	A	0.16	mm ²
Abmessungen der aktiven Chipfläche Dimension of the active chip area	$L \times B$ $L \times W$	0.4×0.4	mm
Abstand Chipoberfläche bis Linsenscheitel Distance chip front to lens top			
SFH 480	H	4.0 ... 4.8	mm
SFH 481	H	2.8 ... 3.7	mm
SFH 482	H	2.1 ... 2.7	mm
Schaltzeiten, I_e von 10% auf 90% und von 90% auf 10%, bei $I_F = 100\text{ mA}$, $R_L = 50\ \Omega$ Switching times, I_e from 10% to 90% and from 90% to 10%, $I_F = 100\text{ mA}$, $R_L = 50\ \Omega$	t_r, t_f	0.6/0.5	μs
Kapazität Capacitance $V_R = 0\text{ V}$, $f = 1\text{ MHz}$	C_o	25	pF
Durchlaßspannung Forward voltage $I_F = 100\text{ mA}$, $t_p = 20\text{ ms}$ $I_F = 1\text{ A}$, $t_p = 100\ \mu\text{s}$	V_F V_F	1.50 (≤ 1.8) 2.4 (< 3.0)	V V
Sperrstrom, Reverse current $V_R = 5\text{ V}$	I_R	0.01 (≤ 1)	μA
Gesamtstrahlungsfluß Total radiant flux $I_F = 100\text{ mA}$, $t_p = 20\text{ ms}$	Φ_e	12	mW
Temperaturkoeffizient von I_e bzw. Φ_e , $I_F = 100\text{ mA}$ Temperature coefficient of I_e or Φ_e , $I_F = 100\text{ mA}$	TC_I	- 0.5	%/K
Temperaturkoeffizient von V_F , $I_F = 100\text{ mA}$ Temperature coefficient of V_F , $I_F = 100\text{ mA}$	TC_V	- 2	mV/K
Temperaturkoeffizient von λ , $I_F = 100\text{ mA}$ Temperature coefficient of λ , $I_F = 100\text{ mA}$	TC_λ	+ 0.25	nm/K

Gruppierung der Strahlstärke I_e in Achsrichtunggemessen bei einem Raumwinkel $\Omega = 0.01$ sr**Grouping of Radiant Intensity I_e in Axial Direction**at a solid angle of $\Omega = 0.01$ sr

Bezeichnung Parameter	Symbol Symbol	Wert Value					Einheit Unit
		SFH 480-2	SFH 480-3	SFH 481	SFH 481-1	SFH 481-2	
Strahlstärke Radiant intensity $I_F = 100$ mA, $t_p = 20$ ms	$I_{e \min}$	> 40	> 63	≥ 10	10	16	mW/sr
	$I_{e \max}$	–	–	–	20	–	mW/sr
Strahlstärke Radiant intensity $I_F = 1$ A, $t_p = 100$ μ s	$I_{e \text{ typ.}}$	540	630	220	130	220	mW/sr

Bezeichnung Parameter	Symbol Symbol	Wert Value					Einheit Unit
		SFH 482	SFH 482-1	SFH 482-2	SFH 482-3	SFH 482-M E 7800 ¹⁾	
Strahlstärke Radiant intensity $I_F = 100$ mA, $t_p = 20$ ms	$I_{e \min}$	≥ 3.15	3.15	5	8	1.6 ... 3.2	mW/sr
	$I_{e \max}$	–	6.3	10	–	–	mW/sr
Strahlstärke Radiant intensity $I_F = 1$ A, $t_p = 100$ μ s	$I_{e \text{ typ.}}$	–	40	65	80	–	mW/sr

1) Die Messung der Strahlstärke und des Halbwinkels erfolgt mit einer Lochblende vor dem Bauteil (Durchmesser der Lochblende: 2.0 mm; Abstand Lochblende zu Gehäuserückseite: 5.4 mm). Dadurch wird sichergestellt, daß bei der Strahlstärkemessung nur diejenige Strahlung in Achsrichtung bewertet wird, die direkt von der Chipoberfläche austritt. Von der Bodenplatte reflektierte Strahlung (vagabundierende Strahlung) wird dagegen nicht bewertet. Diese Reflexionen sind besonders bei Abbildungen der Chipoberfläche über Zusatzoptiken störend (z.B. Lichtschranken großer Reichweite). In der Anwendung werden im allgemeinen diese Reflexionen ebenfalls durch Blenden unterdrückt. Durch dieses, der Anwendung entsprechende Meßverfahren ergibt sich für den Anwender eine besser verwertbare Größe. Diese Lochblendenmessung ist gekennzeichnet durch den Eintrag „E 7800“, der an die Typenbezeichnung angehängt ist.

1) An aperture is used in front of the component for measurement of the radiant intensity and the half angle (diameter of the aperture: 1.1 mm; distance of aperture to case back side: 4 mm). This ensures that solely the radiation in axial direction emitting directly from the chip surface will be evaluated during measurement of the radiant intensity. Radiation reflected by the bottom plate (stray radiation) will not be evaluated. These reflections impair the projection of the chip surface by additional optics (e.g. long-range light reflection switches). In respect of the application of the component, these reflections are generally suppressed by apertures as well. This measuring procedure corresponding with the application provides more useful values. This aperture measurement is denoted by "E 7800" added to the type designation.

Radiation Characteristics, SFH 480 $I_{rel} = f(\varphi)$

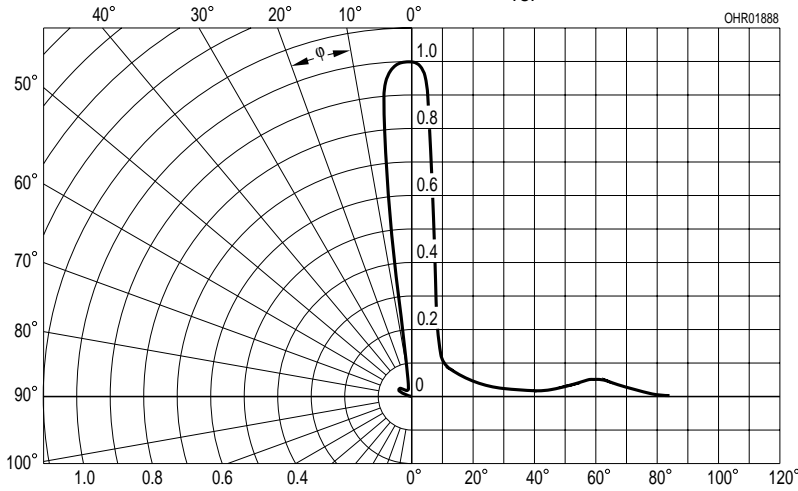

Radiation Characteristics, SFH 481 $I_{rel} = f(\varphi)$

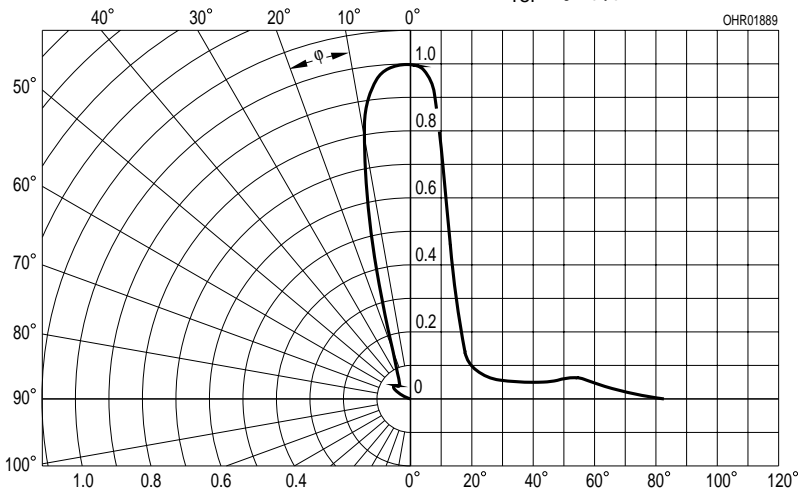

Radiation Characteristics, SFH 482 $I_{rel} = f(\varphi)$

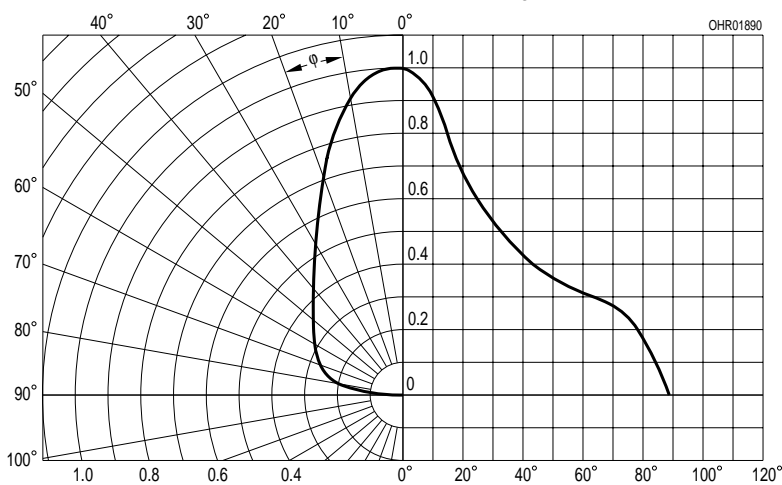

SFH 480, SFH 481, SFH 482

Relative Spectral Emission

$$I_{rel} = f(\lambda)$$

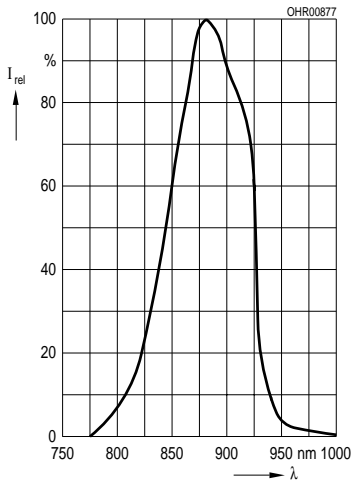

Forward Current, $I_F = f(V_F)$

Single pulse, $t_p = 20 \mu s$

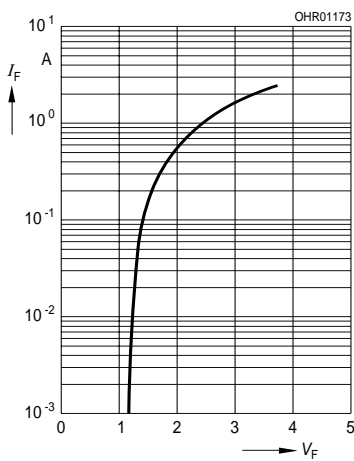

Radiant Intensity $\frac{I_e}{I_e(100mA)} = f(I_F)$

Single pulse, $t_p = 20 \mu s$

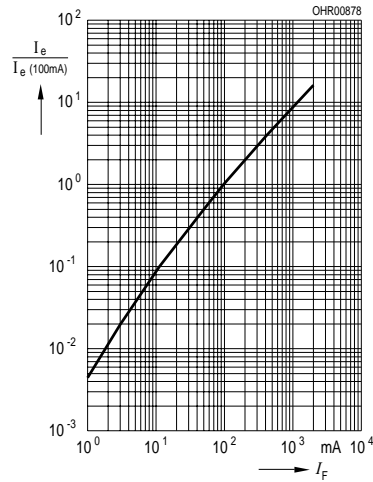

Permissible Pulse Handling Capability $I_F = f(\tau)$, $T_C = 25^\circ C$,

duty cycle $D =$ parameter

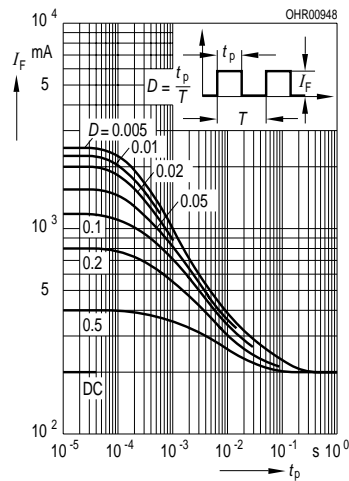

Max. Permissible Forward Current SFH 481, $I_F = f(T_A, T_C)$

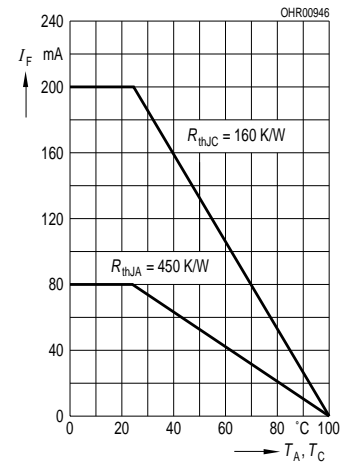

Max. Permissible Forward Current SFH 480, SFH 482, $I_F = f(T_A, T_C)$

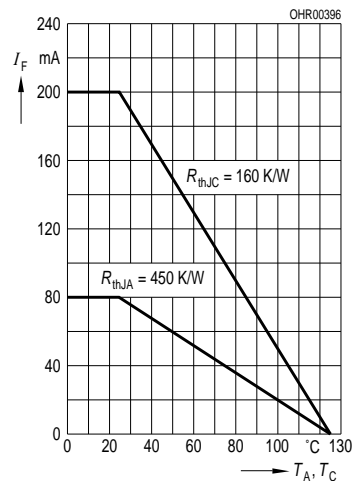

SFH 480, SFH 481, SFH 482

Maßzeichnung Package Outlines

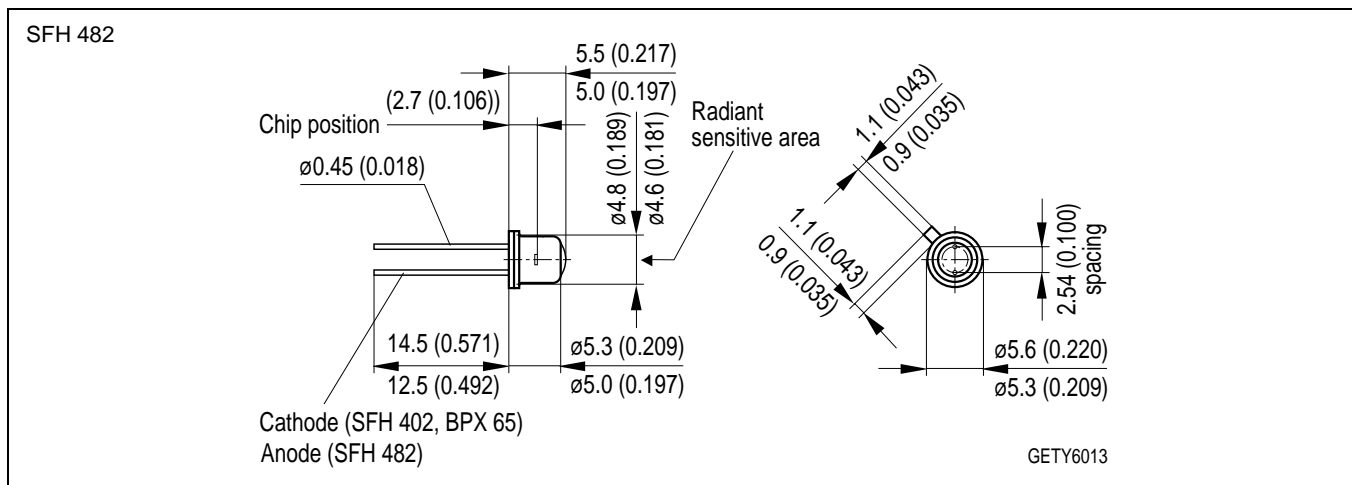
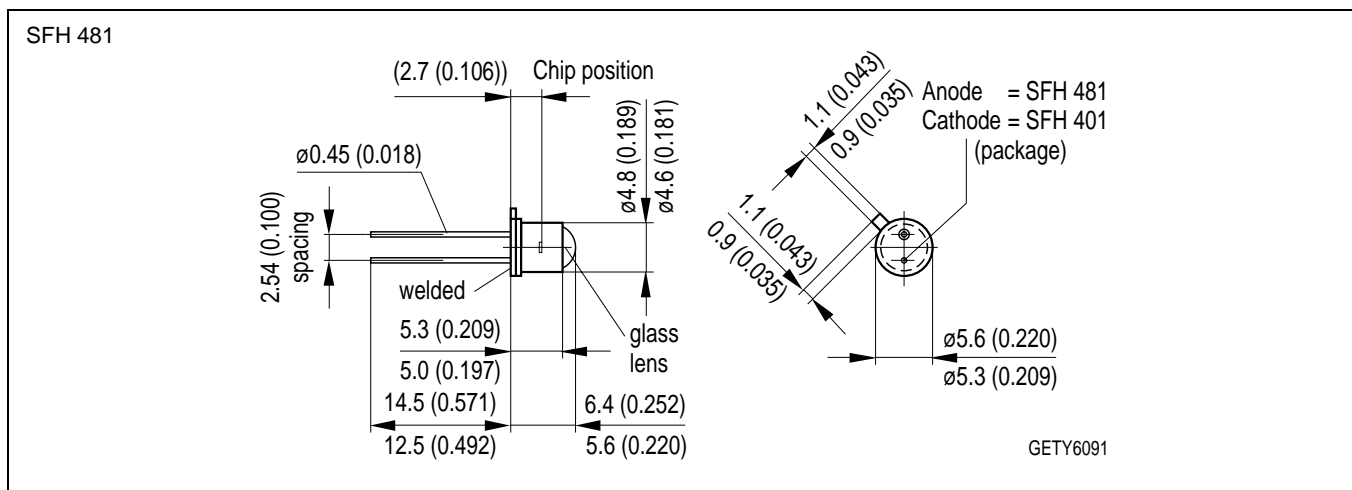
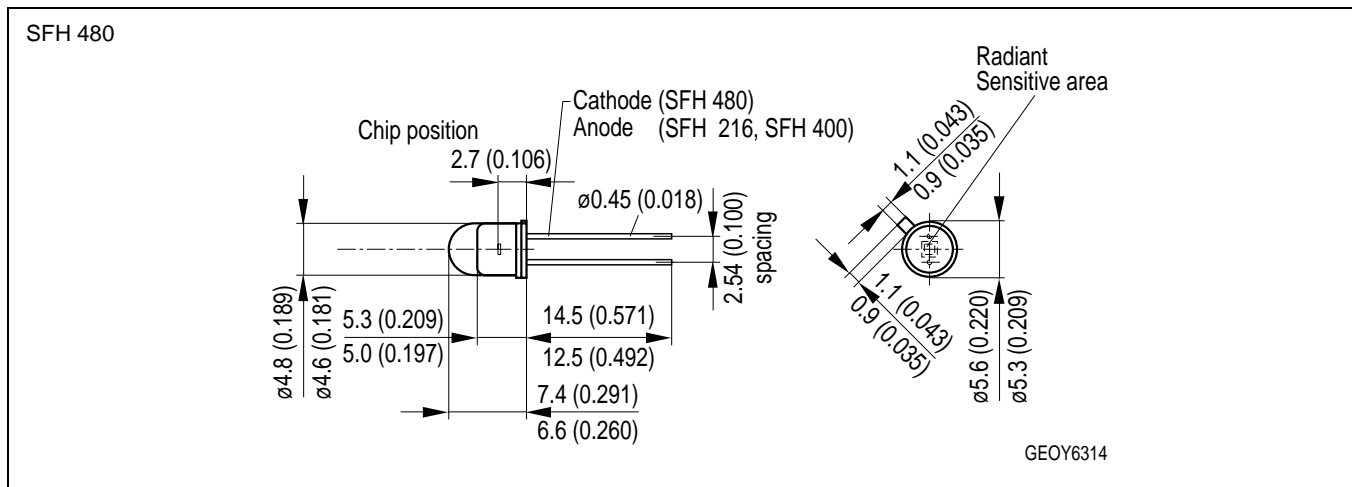

Maße werden wie folgt angegeben: mm (inch) / Dimensions are specified as follows: mm (inch).

Published by OSRAM Opto Semiconductors GmbH & Co. OHG
Wernerwerkstrasse 2, D-93049 Regensburg
© All Rights Reserved.

Attention please!

The information describes the type of component and shall not be considered as assured characteristics. Terms of delivery and rights to change design reserved. Due to technical requirements components may contain dangerous substances. For information on the types in question please contact our Sales Organization.

Packing

Please use the recycling operators known to you. We can also help you – get in touch with your nearest sales office. By agreement we will take packing material back, if it is sorted. You must bear the costs of transport. For packing material that is returned to us unsorted or which we are not obliged to accept, we shall have to invoice you for any costs incurred.

Components used in life-support devices or systems must be expressly authorized for such purpose! Critical components ¹ may only be used in life-support devices or systems ² with the express written approval of OSRAM OS.

¹ A critical component is a component used in a life-support device or system whose failure can reasonably be expected to cause the failure of that life-support device or system, or to affect its safety or effectiveness of that device or system.

² Life support devices or systems are intended (a) to be implanted in the human body, or (b) to support and/or maintain and sustain human life. If they fail, it is reasonable to assume that the health of the user may be endangered.