

Silicon Avalanche Photodiodes

C30902 Series

High Speed APDs for Analytical and Biomedical Lowest Light Detection Applications



Overview

Excelitas' C30902EH avalanche photodiode is fabricated with a double-diffused "reach-through" structure. This structure provides high responsivity between 400 and 1000 nm as well as extremely fast rise and fall times at all wavelengths. The responsivity of the device is independent of modulation frequency up to about 800 MHz. The detector chip is hermetically-sealed behind a flat glass window in a modified TO-18 package. The useful diameter of the photosensitive surface is 0.5 mm.

Excelitas' C30921EH is packaged in a lightpipe TO-18 which allows efficient coupling of light to the detector from either a focused spot or an optical fiber up to 0.25 mm in diameter.

The hermetically-sealed TO-18 package allows fibers to be epoxied to the end of the lightpipe to minimize signal losses

without fear of endangering detector stability.

The C30902SH and C30921SH are selected C30902EH and C30921EH photodiodes having extremely low noise and bulk dark-current. They are intended for ultra-low light level applications (optical power less than 1 pW) and can be used in either their normal linear mode ($V_R < V_{BR}$) at gains up to 250 or greater, or as photon counters in the "Geiger" mode ($V_R > V_{BR}$) where a single photoelectron may trigger an avalanche pulse of about 10^8 carriers. In this mode, no amplifiers are necessary and single-photon detection probabilities of up to approximately 50% are possible.

Photon-counting is also advantageous where gating and coincidence techniques are employed for signal retrieval.

Features and Benefits

- High quantum efficiency of 77% typical @ 830 nm
- C30902SH and C30921SH can be operated in "Geiger" mode
- Hermetically sealed package
- Low Noise at room temperature
- High responsivity - internal avalanche gains in excess of 150
- Spectral response range - (10% points) 400 to 1000 nm
- Time response - typically 0.5 ns
- Wide operating temperature range - -40°C to $+70^{\circ}\text{C}$
- RoHS-compliant

Applications

- LIDAR
- Laser range finder
- Small-signal fluorescence
- Photon counting

Table of Contents

Table 1. Electrical Characteristics	3
Optical Characteristics	4
Maximum Ratings, Absolute-Maximum Values (All Types)	4
“- TC” and “- DTC” TE-Cooled Version	4
RoHS Compliance	5
Custom Designs	5
Geiger Mode Operation	10
Passive-Quenching Circuit	11
Active-Quenching Circuit	12
Timing Resolution	12
After-Pulsing	12
Dark Current	12
“Your Partner of Choice”	13

Table 1. Electrical Characteristics@ T_A = 22°C unless otherwise indicated

	C30902EH, C30921EH			C30902SH, C30921SH			C3092SH-TC, C3092SH-DTC			Units
	Min	Typ	Max	Min	Typ	Max	Min	Typ	Max	
Breakdown voltage, V _{BR}		225			225					V
Temperature coefficient of V _R for constant gain	0.5	0.7	0.9	0.5	0.7	0.9				V/°C
Detector Temperature: ⁵										°C
- TC								0		
- DTC								-20		
Gain		150			250			250		
Responsivity:										A/W
@ 900 nm	55	65		92	108			108		
@ 830 nm	70	77		117	128			128		
Quantum efficiency:										%
@ 900 nm		60			60			60		
@ 830 nm		77			77			77		
Dark current, I _d		15	30		15	30				nA
- TC								2		
- DTC								1		
Noise current, i _n : ²		0.23	0.5		0.11	0.2				pA/Hz ^{1/2}
- TC								0.04		
- DTC								0.02		
Capacitance, C _d		1.6	2		1.6	2		1.6	2	pF
Rise time, t _r :										
R _L = 50Ω, λ = 830 nm, 10% to 90% points		0.5	0.75		0.5	0.75		0.5		ns
Fall time:										
R _L = 50Ω, λ = 830 nm, 90% to 10% points		0.5	0.75		0.5	0.75		0.5		ns
TEC max current										A
- TC								1.8		
- DTC								1.4		
TEC max voltage										V
- TC								0.8		
- DTC								2		
Dark count rate at 5% photon detection probability ³ (830 nm, case temperature of 22°C) (see Figure 10)					5,000	15,000		1,100 (-TC) 250 (- DTC)		cps
Voltage above V _{BR} for 5% photon detection probability ³ (830 nm) (see Figure 8)					2			2		V
After-pulse ratio at 5% photon detection probability (830 nm) 22°C ⁴					2	15		2		%

Note 1: At the DC reverse operating voltage V_R supplied with the device and a light spot diameter of 0.25 mm (C30902EH, SH) or 0.10 mm (C30921EH, SH). Note that a specific value of V_R is supplied with each device. When the photodiode is operated at this voltage, the device will meet the electrical characteristic limits shown above. The voltage value will be within the range of 180 to 250 volts.

Note 2: The theoretical expression for shot noise current in an avalanche photodiode is $i_n = (2q(I_{ds} + (I_{db}M^2 + P_oRM)F)B_w)^{1/2}$ where q is the electronic charge, I_{ds} is the dark surface current, I_{db} is the dark bulk current, F is the excess noise factor, M is the gain, P_o is the optical power on the device, and B_w is the noise bandwidth. For these devices F = 0.98 (2-1/M) + 0.02 M. (Reference: PP Webb, RJ McIntyre, JJ Conradi, "RCA Review", Vol. 35 p. 234, (1974)).

Note 3: The C30902SH and C309021SH can be operated at a substantially higher detection probability. (see Geiger Mode Operation).

Note 4: After-pulse occurring 1 microsecond to 60 seconds after main pulse.

Note 5: A thermistor of 5 KΩ @ 25 °C and 43 KΩ @ -25 °C can be used to monitor the detector temperature.

Optical Characteristics

C30902EH, C30902SH (Figure 11)

Photosensitive Surface:

Shape	Circular
Useful area	0.2 mm ²
Useful diameter	0.5 mm

Field of View:

Approximate full angle for totally illuminated	
Photosensitive surface	100 deg

C30921EH, C30921SH (Figure 12)

Numerical Aperture of Light Pipe0.55

Refractive Index (n) of Core1.61

Lightpipe Core Diameter0.25 mm

Maximum Ratings, Absolute-Maximum Values (All Types)

Reverse Current at 22 °C:

Average value, continuous operation	200 μA
Peak value (for 1 second duration, non-repetitive)	1 mA

Forward Current, IF at 22 °C:

Average value, continuous operation	5 mA
Peak value (for 1 second duration, non-repetitive)	50 mA
Maximum Total Power Dissipation at 22 °C	60 mW

Ambient Temperature:

Storage, Tstg	-60 to + 100 °C
Operating	-40 to + 70 °C
Soldering (for 5 seconds)	200 °C

- TC and - DTC TE-Cooled Versions

The TE- cooled APD can be used for different reasons (Figure 13). Most applications benefits from a TC (single) or DTC (dual) version for two main reasons:

- To reduce the thermal noise for very small signal detection as described previously. The TC version has been design to operate the APD down to 0 °C whereas the DTC version can be operated at -20 °C when the ambient temperature is 22 °C.
- To keep a constant APD temperature irrespective of the ambient temperature. Because APD breakdown voltage decreases with a decrease of temperature, the TE cooler allows a single operating voltage. Also, this configuration allows constant APD performance over an extended ambient temperature range.

The thermistor located inside the unit can be used to monitor the APD temperature and can be used to implement a TE cooler feedback loop to keep the APD at a constant temperature or/and to implement a temperature compensation on the APD bias voltage. A proper heat-sink is required to dissipate the heat generated by the APD and the TE cooler.

RoHS Compliance

This series of APDs are designed and built to be fully compliant with the European Union Directive 2002/95/EEC - Restriction of the use of certain Hazardous Substances in Electrical and Electronic equipment.

Custom Designs

Recognizing that different applications have different performance requirements, Excelitas offers a wide range of customization of these APDs to meet your design challenges. Dark count selection, custom device testing and packaging are among many of the application specific solutions available.

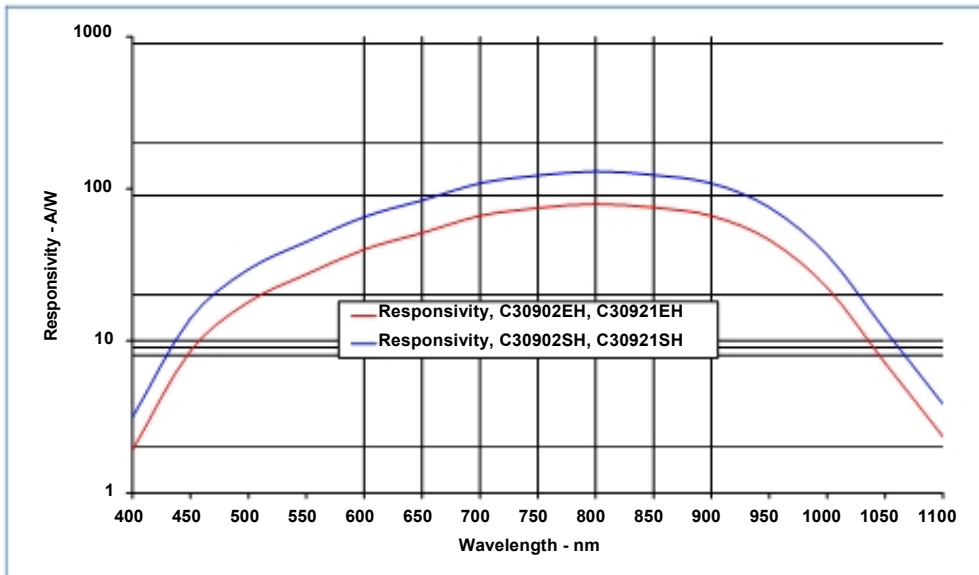

Figure 1
Typical spectral responsivity

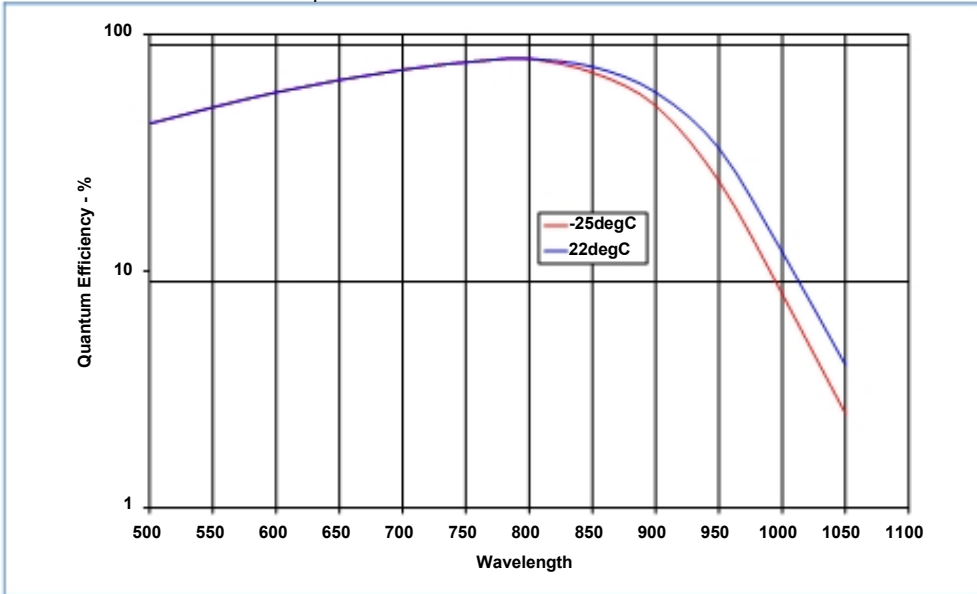

Figure 2
Typical quantum efficiency vs. wavelength

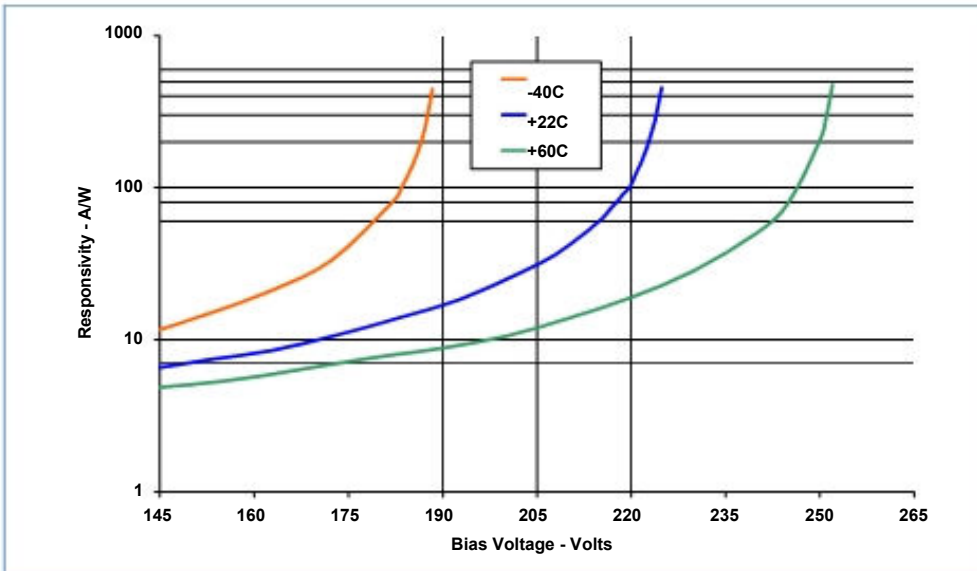

Figure 3
Typical responsivity @ 830 nm vs. operating voltage

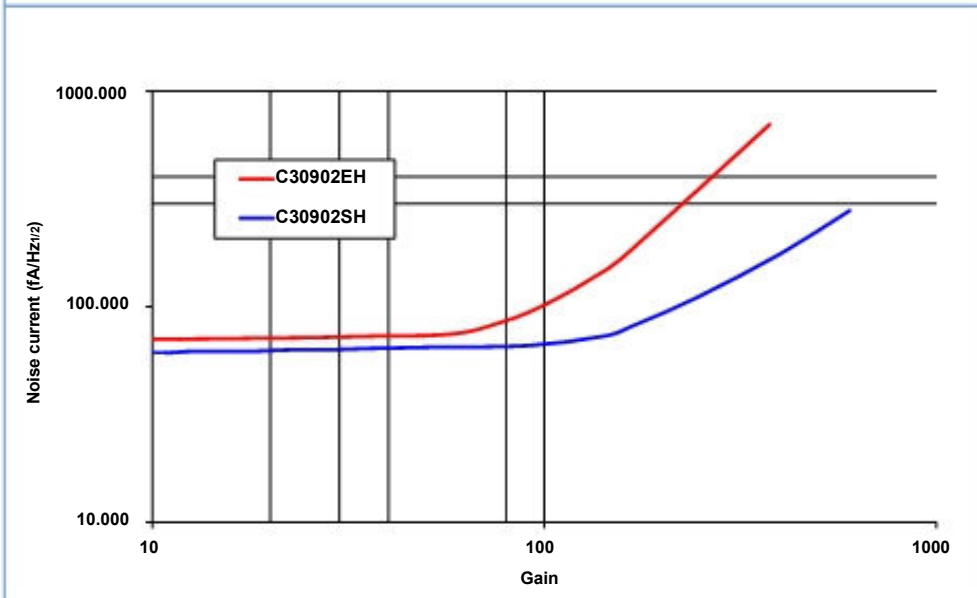

Figure 4
Typical noise current vs. gain

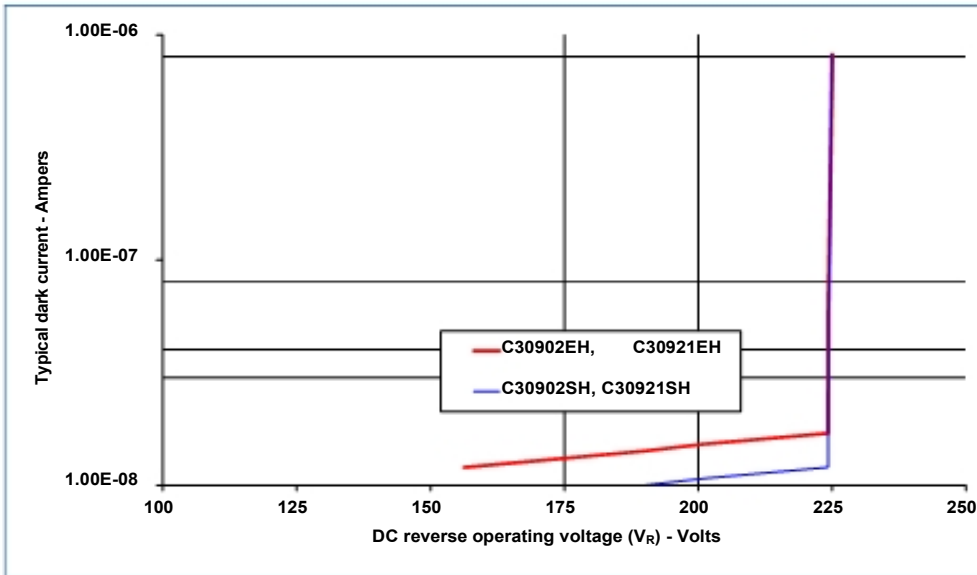

Figure 5
Typical dark current vs. operating voltage @ 22 °C

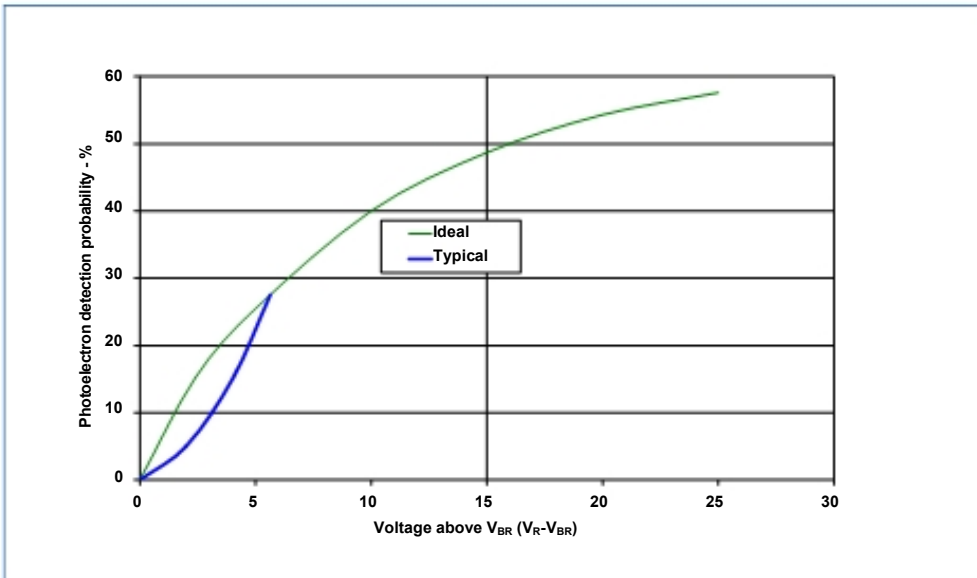
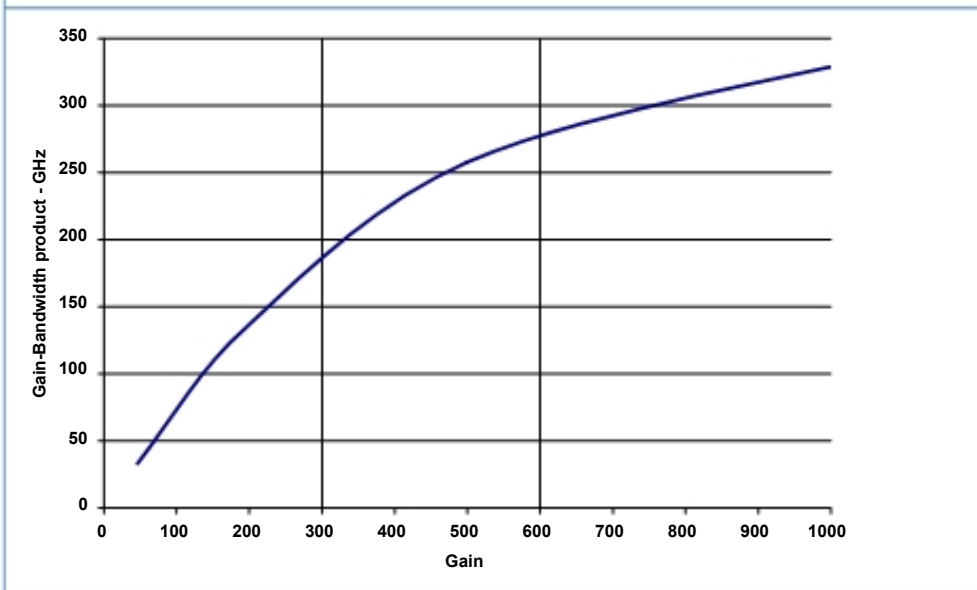

Figure 6
Geiger mode photon detection probability vs. voltage above V_{BR} (V_R>V_{BR}) @ 22 °C



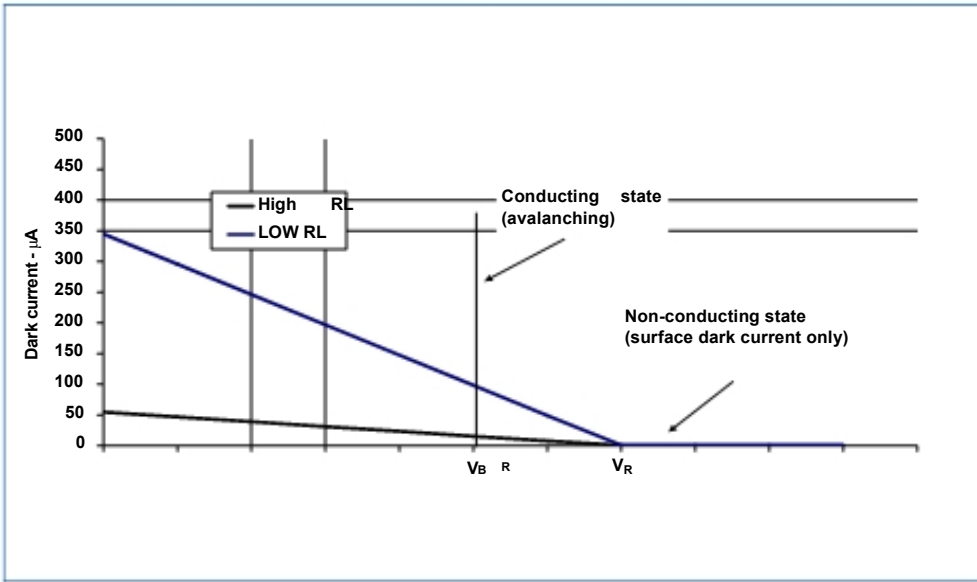

Figure 8
Load Line for C30921SH in the Geiger mode

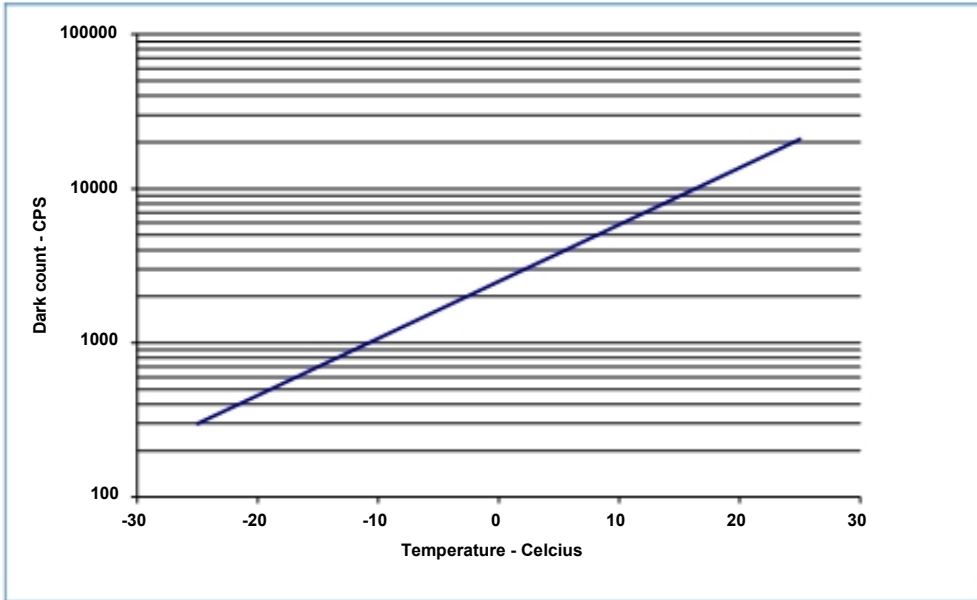

Figure 9
Typical dark count vs. temperature at 5% Photon Detection Efficiency (830 nm)

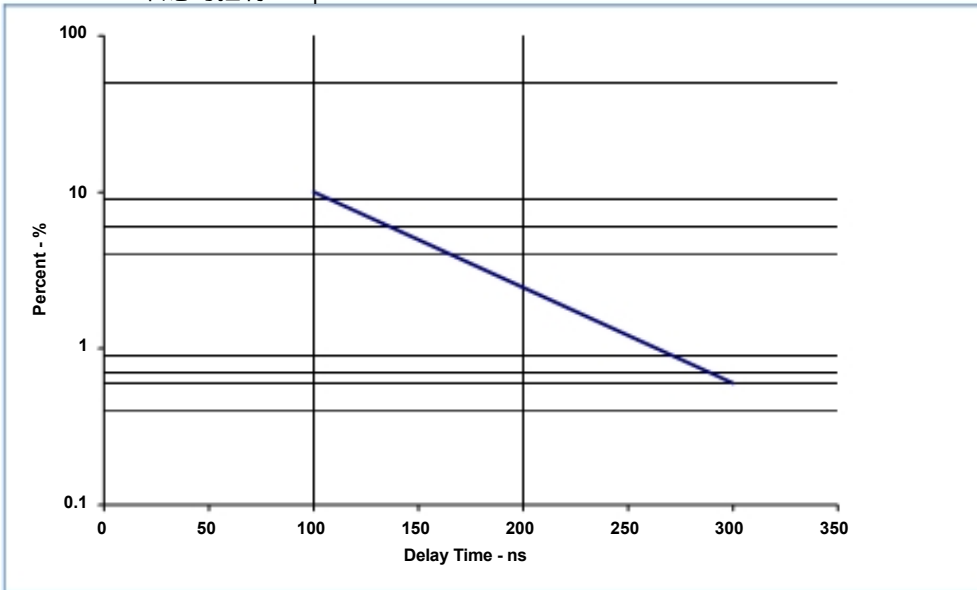

Figure 10

Chance of an after-pulse within the next 100 ns vs. delay-time in an active quenched circuit (typical for C30902SH and C30921SH at V_{BR} , 25 °C)

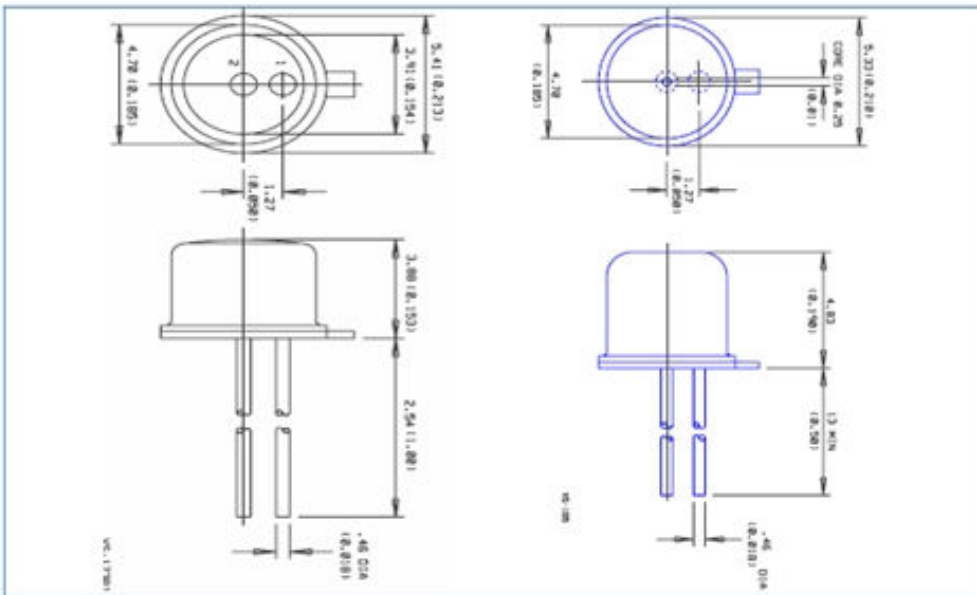

Figure 11

C30902SH (left)
C30921SH (right)
TO-18 Package outline

Dimensions in mm (inches)

Pinout:

1. Positive Lead (Cathode)
2. Negative Lead (Anode)

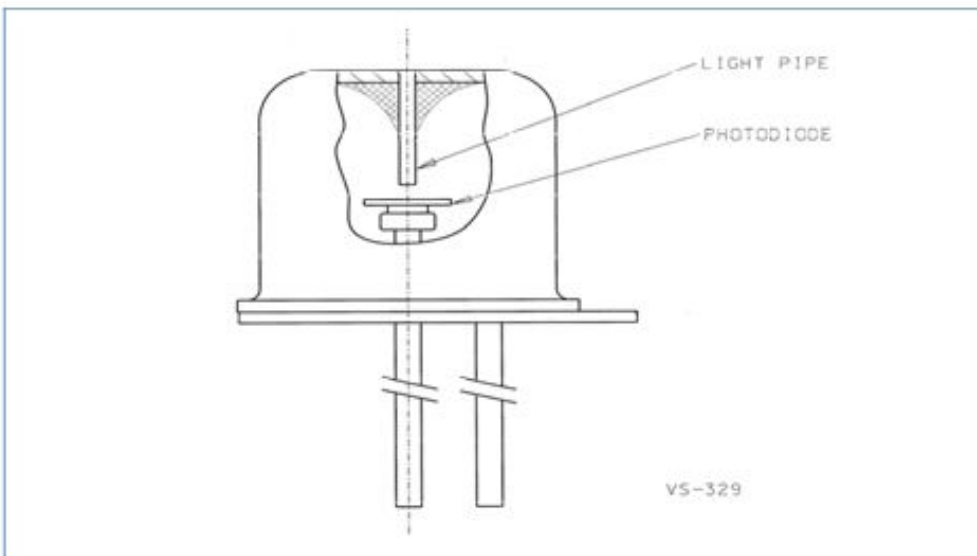

Figure 12

C30921SH, cutaway of the lightpipe package outline

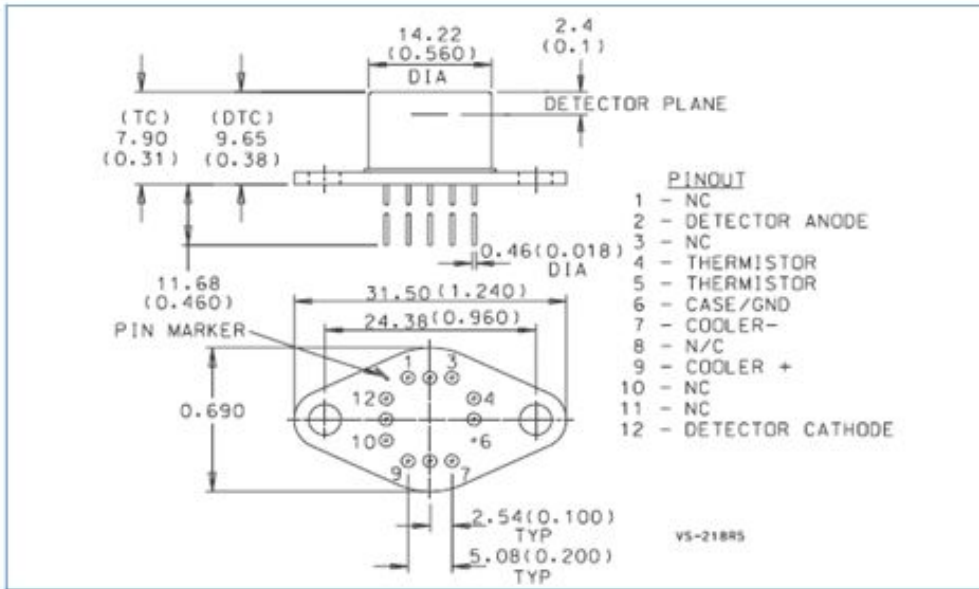

Figure 13

C30902SH-TC, C30902SH-DTC,
TO-66 with flange package outline

Dimensions in mm (inches)

Geiger Mode Operation

When biased above the breakdown voltage, an avalanche photodiode will normally conduct a large current. However, if the current is such that the current is limited to less than a particular value (about 50 μA for these diodes), the current is unstable and can switch off by itself. The explanation of this behaviour is that the number of carries in the avalanche region at any one time is small and fluctuating wildly. If the number happens to fluctuate to zero, the current must stop. If subsequently remains off until the avalanche pulse is retriggered by a bulk or photo-generated carrier.

The “S” versions are selected to have a small bulk-generated dark-current. This makes them suitable for low-noise operation below V_{BR} or photon-counting above V_{BR} in the Geiger mode. In this so-called Geiger mode, a single photoelectron (or thermally-generated electron) may trigger an avalanche pulse which discharges the photodiode from its reverse voltage V_R to a voltage slightly below V_{BR} . The probability of this avalanche occurring is shown in Figure 6 as the “Photoelectron Detection Probability” and as can be seen, it increases with reverse voltage V_R . For a given value of $V_R - V_{BR}$, the Photoelectron Detection Probability is independent of Temperature. To determine the Photon Detection Probability, it is necessary to multiply the Photon Detection Probability by the Quantum Efficiency, which is shown in Figure 2. The Quantum Efficiency also is relatively independent of temperature, except near the 1000 nm cut-off.

The “S” versions can be used in the Geiger mode using either “passive” or “active” pulse quenching circuits. The advantages and disadvantages of each are discussed below.

Passive-Quenching Circuit

The simplest, and in many case a perfectly adequate method of quenching a breakdown pulse, is through the use of a current limiting load resistor. An example of such a “passive” quenching is shown in Figure 14. The load-line of the circuit is shown in Figure 8. To be in the conducting state at V_{BR} two conditions must be met:

1. The Avalanche must have been triggered by either a photoelectron or a bulk-generated electron entering at the avalanche region of the diode. (Note: holes are inefficient at starting avalanches in silicon.) The probability of an avalanche being initiated is discussed above.
2. To continue to be in the conducting state a sufficiently large current, called the latching current I_{LATCH} , must be passing through the device so that there is always an electron or hole in the avalanche region. Typically in the C30902SH and C30921SH, $I_{LATCH} = 50\mu A$. For currents $(V_B - V_{BR})/R_L$, much greater than I_{LATCH} , the diode remains conducting. If the current $(V_R - V_{BR})/R_L$, is much less than I_{LATCH} , the diode switches almost immediately to the non-conducting state. If $(V_R - V_{BR})/R_L$ is approximately equal to I_{LATCH} , then the diode will switch at an arbitrary time from the conducting to the non-conducting state depending on when the number of electrons and holes in the avalanche region statistically fluctuates to zeros.

When R_L is large, the photodiode is normally conducting, and the operating point is at $V_R - I_{DS}R_L$ in the non-conducting state. Following an avalanche breakdown, the device recharges to the voltage $V_R - I_{DS}R_L$ with the time constant $R_L C$ where C is the total device capacitance including stray capacitance. Using $C = 1.6pF$ and $R_L = 200.2k\Omega$ a recharge time constant of $0.32\mu s$ is calculated. The rise-time is fast, 5 to 50ns, and decreases as $V_R - V_{BR}$ increases, and is very dependent on the capacitances of the load resistors, leads, etc. The jitter at the half-voltage point is typically the same order of magnitude as the rise-time. For timing purposes where it is important to have minimum jitter, the lowest possible threshold of the rising pulse should be used.

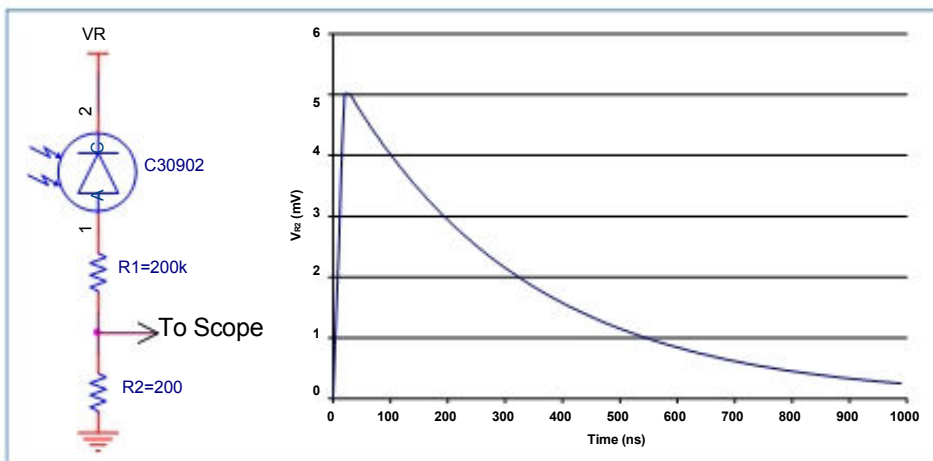

Figure 14
Sample of passive quench circuit

Active-Quenching Circuit

Until the C30902SH is recharged, the probability of detecting another incoming photoelectron is relatively low. To avoid an excessive dead-time when operating at a large voltage above V_{BR} , an “actively quenched” circuit can be used. The circuit temporarily drops the bias voltage for a fraction of a microsecond following the detection of an avalanche discharge. This delay time allows all electrons and holes to be collected, including most of those temporarily “trapped” at various impurity sites in the silicon. When the higher voltage is reapplied, there are no electrons in the depletion region to trigger another avalanche or latch the diode. Recharging can now be very rapid through a small load resistor. Alternatively, the bias voltage can be maintained but the load resistor is replaced by a transistor which is kept off for a short time after an avalanche, and then turned on for a period sufficient to recharge the photodiode.

Timing Resolution

For photon counting application, the time of the TTL triggered pulse after detecting a photon, when plotted on a curve, take the FWHM averaged, is the timing resolution or time jitter. The jitter at the half-voltage point is typically the same order of magnitude as the rise-time. For timing purposes where it is important to have minimum jitter, the lowest possible threshold of the rising pulse should be used.

After-Pulsing

An after-pulse is an avalanche breakdown pulse which follows a photon-generated pulse and is induced by it. An after-pulse is usually caused by one of the approximately 10^8 carriers which pass through the diode during an avalanche. This electron or hole is captured and trapped at some impurity site in the silicon, as previously described. When this charge-carrier is liberated, usually in less than 100ns but sometimes several milliseconds later, it may start another avalanche. The probability of an after-pulse occurring more than one microsecond later is typically less than 1% at 2 volts above V_{BR} , using the circuit shown in Figure 14.

After-pulsing increases with bias voltage. If it is necessary to reduce after-pulses, it is recommended that one keep $V_R - V_{BR}$ low, use an actively-quenched circuit with a long delayline, or a passively-quenched circuit with a long $R_L C$ constant. Stray capacitances must also be minimized. Electronic gating of the signal can be performed in certain situations. Should after-pulses be a serious complication in a particular application, operation below V_{BR} with a good amplifier might be considered.

Dark Current

“S” versions have been selected to have a low dark-count rate. Cooling to -25°C can reduce this by a factor of 50, since the dependence of dark-count rate on temperature is exponential.

The dark-count increases with voltage following the same curve as the Photoelectron Detection Probability until a voltage where after-pulsing is responsible for a feedback mechanism which dramatically increases the dark-count rate. This maximum voltage is circuit dependant, and is not warranted other than the values listed on Table 1. In most cases, with a delay time of 300 ns, the diode can be used effectively at V_R up to $V_{BR} + 25\text{V}$.

The C30902 should not be forward biased or, when unbiased, exposed to strong illumination. These conditions result in a greatly enhanced dark-count, which requires up to 24 hours to return to its nominal value.

Your Partner of Choice

With a broad customer base in all major markets, built on ninety years of solid trust and cooperation with our customers, Excelitas is recognized as a reliable partner that delivers high quantity, customized, and superior "one-stop" solutions. Our products - from single photocells to complex x-ray inspection systems - meet the highest quality and environmental standards. Our worldwide Centres of Excellence, along with our Customer and Technical Support teams, always work with you to find the best solutions for your specific needs.

North America Customer Support Hub
Excelitas Technologies
22001 Dumberry Road
Vaudreuil-Dorion, Québec
Canada J7V 8P7
Telephone: (+1) 450 424 3300,
(+1) 866 574 6786 (toll-free)
Fax: (+1) 450 424 3345
generalinquiries@excelitas.com

European Headquarters
Excelitas Technologies
Wenzel-Jaksch-Str. 31
65199 Wiesbaden, Germany
Telephone: (+49) 611-492-247
Fax: (+49) 611-492-170

Asia Headquarters
Excelitas Technologies
47 Ayer Rajah Crescent #06-12
Singapore 139947
Telephone: (+65) 6775-2022
Fax: (+65) 6775-1008



For a complete listing of our global offices, visit www.excelitas.com

©2011 Excelitas Technologies Corp. All rights reserved. The Excelitas logo and design are registered trademarks of Excelitas Technologies Corp. All other trademarks not owned by Excelitas Technologies or its subsidiaries that are depicted herein are the property of their respective owners. Excelitas reserves the right to change this document at any time without notice and disclaims liability for editorial, pictorial or typographical errors. 600182_02 DTS0408