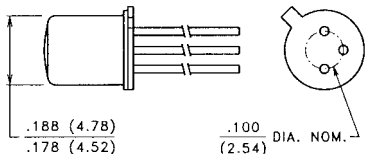
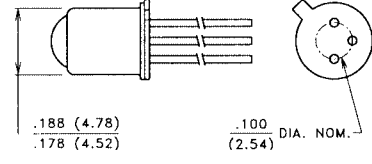
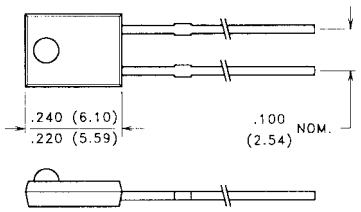
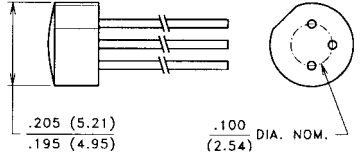
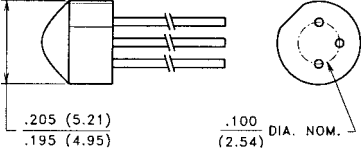
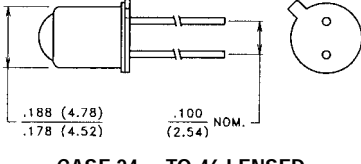

Phototransistor and IRED Part Number Index

Phototransistor Part No.	Page	Infrared Emitter Part No.	Page
VTT1015	102	VTE1013	126
VTT1016	102	VTE1063	111
VTT1017	102	VTE1113	127
VTT1115	103	VTE1163	112
VTT1116	103	VTE1261	113
VTT1117	103	VTE1262	113
VTT1212	99	VTE1281-1	114
VTT1214	99	VTE1281-2	114
VTT1222W	93	VTE1281F	115
VTT1223W	93	VTE1281W-1	116
VTT1225	94	VTE1281W-2	116
VTT1226	94	VTE1285	117
VTT1227	94	VTE1291-1	118
VTT3323LA	95	VTE1291-2	118
VTT3324LA	95	VTE1291W-1	119
VTT3325LA	95	VTE1291W-2	119
VTT3423LA	96	VTE1295	120
VTT3424LA	96	VTE3322LA	128
VTT3425LA	96	VTE3324LA	128
VTT7122	97	VTE3372LA	121
VTT7123	97	VTE3374LA	121
VTT7125	97	VTE7172	122
VTT7222	98	VTE7173	122
VTT7223	98		
VTT7225	98		
VTT9002	100		
VTT9003	100		
VTT9102	101		
VTT9103	101		

Phototransistor and IRED Selection Guide

PACKAGE OUTLINE inch (mm)	PART NO.	FEATURES	PAGE
 <p>CASE 1 TO-46 FLAT WINDOW</p>	VTT1015 VTT1016 VTT1017	.050" x .050" NPN Phototransistor Hermetic Case ±35° Acceptance Angle	102
 <p>CASE 2 TO-46 LENSED</p>	VTT1115 VTT1116 VTT1117	.050" x .050" NPN Phototransistor Hermetic Case ±15° Acceptance Angle	103
 <p>CASE 7 LATERAL</p>	VTE7172 VTE7173	.011" x .011" GaAlAs IRED	122
	VTT7122 VTT7123 VTT7125	.025" x .025" NPN Phototransistor	97
	VTT7222 VTT7223 VTT7225	.025" x .025" NPN Phototransistor Infrared Transmitting	98
 <p>CASE 8 TO-106 CERAMIC, FLAT</p>	VTT9002 VTT9003	.040" x .040" NPN Phototransistor ±50° Acceptance Angle	100
 <p>CASE 9 TO-106 CERAMIC, LENSED</p>	VTT9102 VTT9103	.040" x .040" NPN Phototransistor ±40° Acceptance Angle	101
 <p>CASE 24 TO-46 LENSED</p>	VTE1113	GaAs IRED Hermetic Case ±10° Emission Angle	127
	VTE1163	GaAlAs IRED Hermetic Case ±10° Emission Angle	112

Phototransistor and IRED Selection Guide

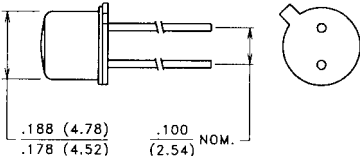
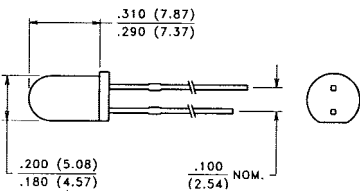
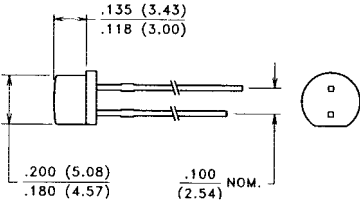
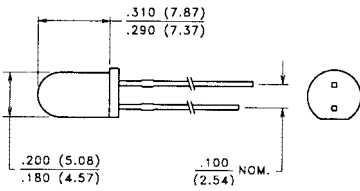
PACKAGE OUTLINE inch (mm)	PART NO.	FEATURES	PAGE
 <p>CASE 24A TO-46 FLAT WINDOW</p>	VTE1013	GaAs IRED Hermetic Case ±35° Emission Angle	126
	VTE1063	GaAlAs IRED Hermetic Case ±35° Emission Angle	111
 <p>CASE 26 T-1 ¾ (5 mm)</p>	VTE1261 VTE1262	GaAlAs IRED ±10° Emission Angle	113
	VTE1281-1 VTE1281-2	GaAlAs IRED ±12° Emission Angle	114
	VTE1291-1 VTE1291-2	GaAlAs IRED ±12° Emission Angle	118
	VTT1212 VTT1214	.040" x .040" NPN Phototransistor ±10° Acceptance Angle	99
	VTT1225 VTT1226 VTT1227	.025" x .025" NPN Phototransistor ±5° Acceptance Angle	94
 <p>CASE 26F T-1 ¾ (5 mm) FLAT</p>	VTE1281F	GaAlAs IRED ±45° Emission Angle	115
 <p>CASE 26W T-1 ¾ (5 mm) WIDE ANGLE</p>	VTE1281W-1 VTE1281W-2	GaAlAs IRED ±25° Emission Angle	116
	VTE1291W-1 VTE1291W-2	GaAlAs IRED ±25° Emission Angle	119
	VTT1222W VTT1223W	.025" x .025" NPN Phototransistor ±40° Acceptance Angle	93

Phototransistor and IRED Selection Guide

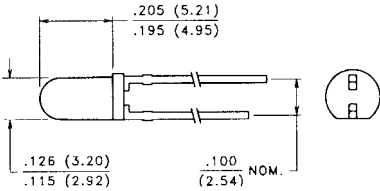
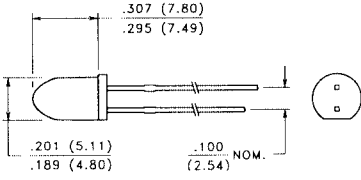
PACKAGE OUTLINE inch (mm)	PART NO.	FEATURES	PAGE
 <p>CASE 50A LONG T-1 (3 mm)</p>	VTE3322LA VTE3324LA	GaAs IRED ±10° Emission Angle	128
	VTE3372LA VTE3374LA	GaAlAs IRED ±10° Emission Angle	121
	VTT3323LA VTT3324LA VTT3325LA	.025" x .025" NPN Phototransistor ±10° Acceptance Angle	95
	VTT3423LA VTT3424LA VTT3425LA	.025" x .025" NPN Phototransistor ±10° Acceptance Angle Infrared Transmitting	96
 <p>CASE 62 T-1 ¾ (5 mm) BULLET</p>	VTE1285	GaAlAs IRED ±8° Emission Angle	117
	VTE1295	GaAlAs IRED ±8° Emission Angle	120

Typical Phototransistor and IRED Applications

Why Use Phototransistors?

Phototransistors are solid state light detectors that possess internal gain. This makes them much more sensitive than photodiodes of comparably sized area. These devices can be used to provide either an analog or digital output signal. This family of detectors offers the following general characteristics and features:

- *Low cost visible and near-IR photodetection*
- *Available with gains from 100 to over 1500*
- *Moderately fast response times*
- *Available in a wide range of packages including epoxy coated, transfer molded, cast, hermetic packages, and in chip form*
- *Usable with almost any visible or near infrared light source such as IREDs; neon, fluorescent, incandescent bulbs; lasers; flame sources; sunlight; etc.*
- *Same general electrical characteristics as familiar signal transistors (except that incident light replaces base drive current)*

Why Use IREDs?

IREDs are solid state light sources which emit light in the near-IR part of the spectrum. Because they emit at wavelengths which provide a close match to the peak spectral response of silicon photodetectors, both GaAs and GaAlAs IREDs are often used with phototransistors. Key characteristics and features of these light sources include:

- *Long operating lifetimes*
- *Low power consumption, compatible with solid state electronics*
- *Narrow band of emitted wavelengths*
- *Minimal generation of heat*
- *Available in a wide range of packages including transfer molded, cast, and hermetic packages*
- *Low cost*

Typical Phototransistor and IRED Applications

Applications

Phototransistors can be used as ambient light detectors. When used with a controllable light source, typically an IRED, they are often employed as the detector element for optoisolators and transmissive or reflective optical switches. Typical configurations include:

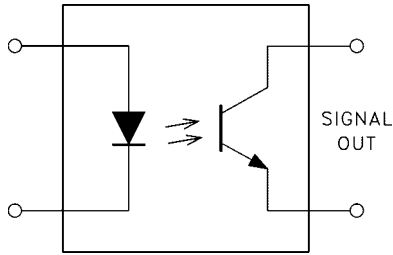

Optoisolator

The optoisolator is similar to a transformer in that the output is electronically isolated from the input.

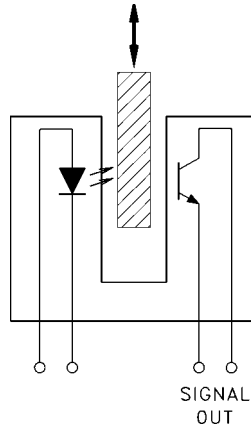

Optical Switch

An object is detected when it enters the gap of the optical switch and blocks the light path between the emitter and detector.

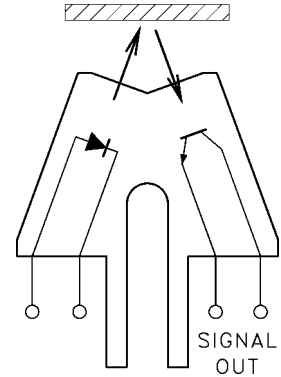

Retro Sensor

The retro sensor detects the presence of an object by generating light and then looking for its reflectance off of the object to be sensed.

Phototransistors and IREDs have been used in the following applications.

Computer/Business Equipment

- Write protect control - floppy drive
- Margin controls - printers
- Monitor paper position - copiers
- Monitor paper stack height - copiers

Industrial

- LED light source - light pens
- Security systems
- Safety shields
- Encoders - measure speed and direction
- Photoelectric controls
- Remote residential electric meter reading

Consumer

- Coin counters
- Lottery card readers
- Position sensors - joysticks
- Remote controllers - toys, appliances, audio/visual equipment
- Games - laser tag
- Camera shutter control

Typical Phototransistor and IRED Applications

Fundamental Circuit Approaches

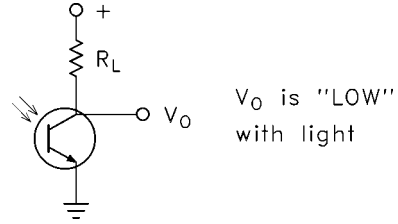
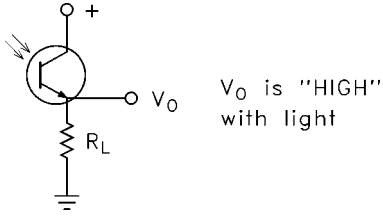

Basic Circuits

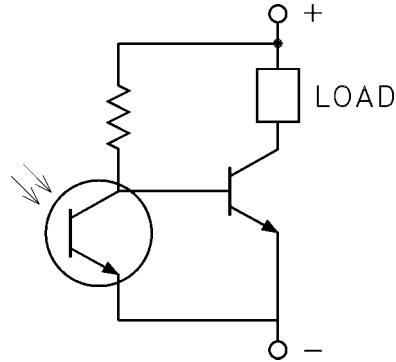
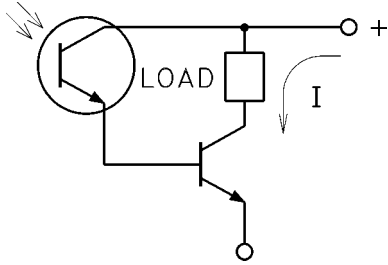

More Output Current Capability

More Voltage Switching Capability

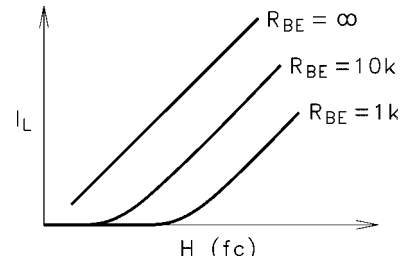
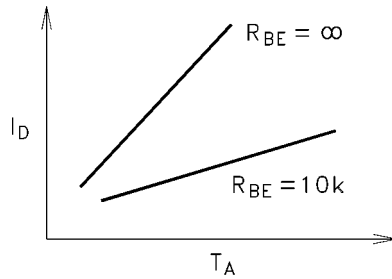
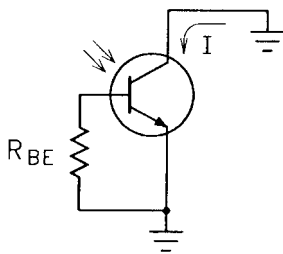

Reducing Dark Current

What are Phototransistors?

Phototransistors are photodiode-amplifier combinations integrated within a single silicon chip. These combinations are put together in order to overcome the major limitation of photodiodes: unity gain.

Many applications demand a greater output signal from the photodetector than can be generated by a photodiode alone. While the signal from a photodiode can always be amplified through use of an external op-amp or other circuitry, this approach is often not as practical or as cost effective as the use of phototransistors.

The phototransistor can be viewed as a photodiode whose output photocurrent is fed into the base of a conventional small signal transistor. While not required for operation of the device as a photodetector, a base connection is often provided allowing the designer the option of using base current to bias the transistor. The typical gain of a phototransistor can range from 100 to over 1500.

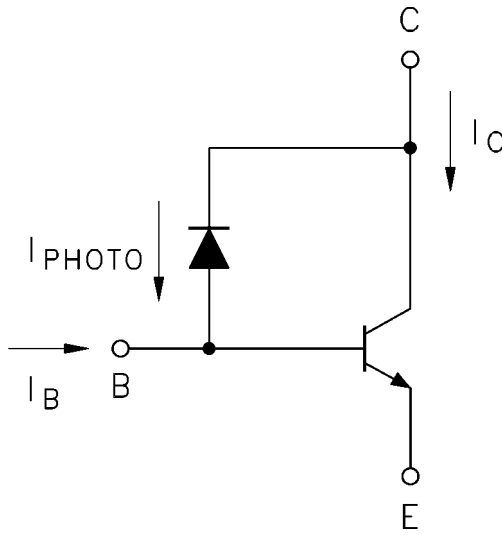

Phototransistor Equivalent Circuit

To demonstrate the relative sensitivity of these different types of detectors, compare the output currents that could be expected from a .025" x .025" detector chip exposed to .05 mW/cm² of illumination.

DETECTOR	GAIN	OUTPUT CURRENT
Photodiode	1x	100nA
Phototransistor	500x	50 μA

The current-voltage characteristics of the phototransistor are similar to NPN signal transistors, with the major exception that incident light provides the base drive current.

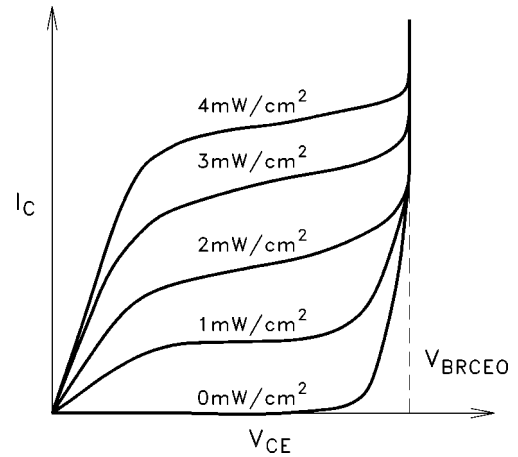

Phototransistor Collector Current (I_C) versus Collector to Emitter Voltage (V_{CE}) as a function in incident energy

The structure of a phototransistor is very similar to that of a photodiode. In fact, while not optimized for this mode of operation, the collector-base junction of a phototransistor can be used as a photodiode with fairly good results. The major structural difference is that the phototransistor has two junctions compared with one for the photodiode.

COLLECTOR CONTACT
(BACKSIDE OF CHIP)

BASE CONTACT

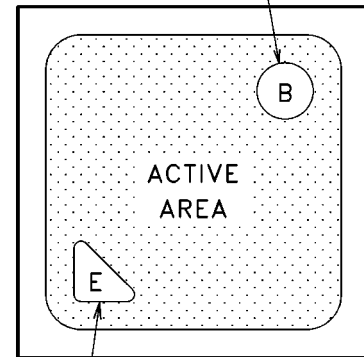

EMITTER CONTACT

PASSIVATION

BASE CONTACT

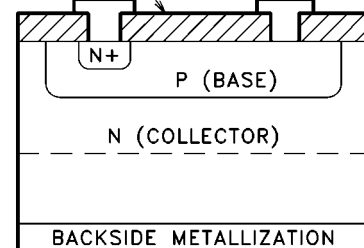

COLLECTOR CONTACT

Phototransistor Chip Top View and Cut Away View

Characteristics of Phototransistors

An equivalent circuit for a phototransistor consists of a photodiode feeding its output photocurrent into the base of a small signal transistor. Based on this model it is not surprising that phototransistors display some of the characteristics of both types of devices.

Spectral Response

The output of a phototransistor is dependent upon the wavelength of incident light. These devices respond to light over a broad range of wavelengths from the near UV, through the visible, and into the near IR part of the spectrum. Unless optical filters are used, the peak spectral response is in the near IR at approximately 840 nm. The peak response is at a somewhat shorter wavelength than that of a typical photodiode. This is because the diffused junctions of a phototransistor are formed in epitaxial rather than crystal grown silicon wafers.

Phototransistors will respond to fluorescent or incandescent light sources but display better optical coupling efficiencies when matched with IREDS.

Sensitivity

For a given light source and illumination level, the output of a phototransistor is defined by the area of the exposed collector-base junction and the dc current gain of the transistor. The collector-base junction of the phototransistor functions as a photodiode generating a photocurrent which is fed into the base of the transistor section. Thus, like the case for a photodiode, doubling the size of the base region doubles the amount of generated base photocurrent. This photocurrent (I_p) then gets amplified by the dc current gain of the transistor. For the case where no external base drive current is applied:

$$I_C = h_{FE} (I_p)$$

where:

- I_C = collector current
- h_{FE} = DC current gain
- I_p = photocurrent

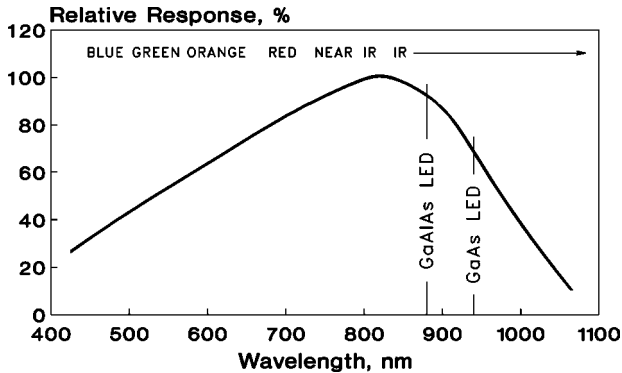

As is the case with signal transistors, h_{FE} is not a constant but varies with base drive, bias voltage, and temperature. At low light levels the gain starts out small but increases with increasing light (or base drive) until a peak is reached. As the light level is further increased the gain of the phototransistor starts to decrease.

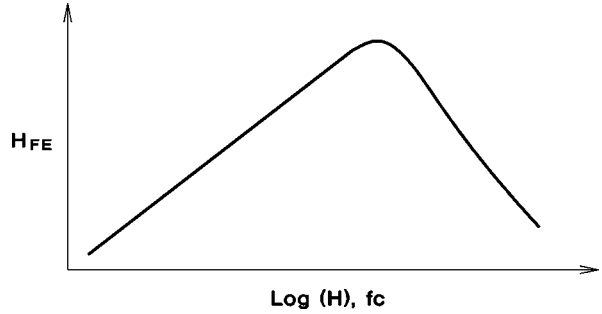

Transistor Gain vs Light Intensity

h_{FE} will also increase with increasing values for V_{CE} . The current-voltage characteristics of a typical transistor will demonstrate this effect. For a constant base drive the curve shows a positive slope with increasing voltage.

It is clear the current gain at collector-emitter voltage V_{CE2} is greater than the current gain at V_{CE1} .

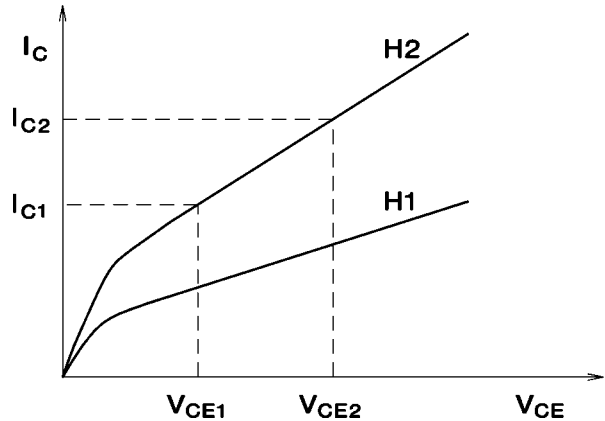

Current vs Voltage Curves

The current gain will also increase with increasing temperature.

Characteristics of Phototransistors

Linearity

Unlike a photodiode whose output is linear with respect to incident light over 7 to 9 decades of light intensity, the collector current (I_C) of a phototransistor is linear for only 3 to 4 decades of illumination. The prime reason for this limitation is that the dc gain (h_{FE}) of the phototransistor is a function of collector current (I_C) which in turn is determined by the base drive. The base drive may be in the form of a base drive current or incident light.

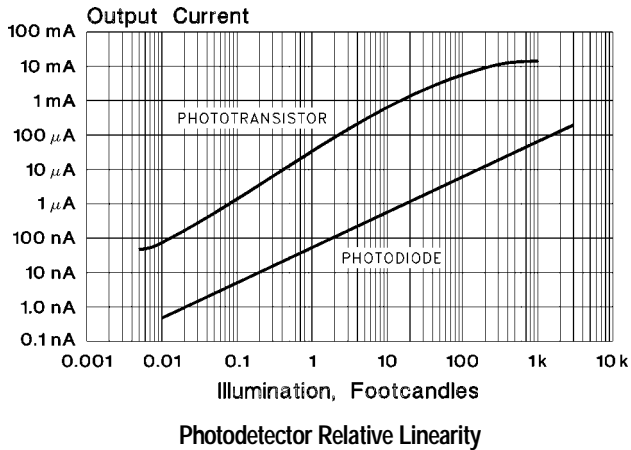

While photodiodes are the detector of choice when linear output versus light intensity is extremely important, as in light intensity measuring equipment, the phototransistor comes into its own when the application requires a photodetector to act like a switch. When light is present, a phototransistor can be considered "on", a condition during which they are capable of sinking a fair amount of current. When the light is removed these photodetectors enter an "off" state and function electrically as open switches. How well phototransistors function as switches is covered in the next few sections.

Collector-Emitter Saturation Voltage - $V_{CE(SAT)}$

By definition, saturation is the condition in which both the emitter-base and the collector-base junctions of a phototransistor become forward biased. From a practical standpoint the collector-emitter saturation voltage, $V_{CE(SAT)}$, is the

parameter which indicates how closely the photodetector approximates a closed switch. This is because $V_{CE(SAT)}$ is the voltage dropped across the detector when it is in its "on" state.

$V_{CE(SAT)}$ is usually given as the maximum collector-emitter voltage allowed at a given light intensity and for a specified value of collector current. PerkinElmer tests their detectors for $V_{CE(SAT)}$ at a light level of 400 fc and with 1 mA of collector current flowing through the device. Stock phototransistors are selected according to a set of specifications where $V_{CE(SAT)}$ can range from 0.25V (max) to 0.55V (max) depending on the device.

Dark Current - (I_D)

When the phototransistor is placed in the dark and a voltage is applied from collector to emitter, a certain amount of current will flow. This current is called the dark current (I_D). This current consists of the leakage current of the collector-base junction multiplied by the dc current gain of the transistor. The presence of this current prevents the phototransistor from being considered completely "off", or being an ideal "open" switch.

The dark current is specified as the maximum collector current permitted to flow at a given collector-emitter test voltage. The dark current is a function of the applied collector-emitter voltage and ambient temperature.

PerkinElmer's standard phototransistors are tested at a V_{CE} applied voltage of either 5V, 10V or 20V depending on the device. Phototransistors are tested to dark current limits which range from 10 nA to 100 nA.

Dark current is temperature dependent, increasing with increasing temperature. It is usually specified at 25°C.

Breakdown Voltages - (V_{BR})

Phototransistors must be properly biased in order to operate. However, when voltages are applied to the phototransistor, care must be taken not to exceed the collector-emitter breakdown voltage (V_{BREC0}). Exceeding the breakdown voltage can cause permanent damage to the phototransistor. Typical values for V_{BREC0} range from 20V to 50V. Typical values for V_{BREC0} range from 4V to 6V. The breakdown voltages are 100% screened parameters.

Characteristics of Phototransistors

Speed of Response

The speed of response of a phototransistor is dominated almost totally by the capacitance of the collector-base junction and the value of the load resistance. These dominate due to the Miller Effect which multiplies the value of the RC time constant by the current gain of the phototransistor. This leads to the general rule that for devices with the same active area, the higher the gain of the photodetector, the slower will be its speed of response.

A phototransistor takes a certain amount of time to respond to sudden changes in light intensity. This response time is usually expressed by the rise time (t_R) and fall time (t_F) of the detector where:

t_R - The time required for the output to rise from 10% to 90% of its on-state value.

t_F - The time required for the output to fall from 90% to 10% of its on-state value.

As long as the light source driving the phototransistor is not intense enough to cause optical saturation, characterized by the storage of excessive amounts of charge carriers in the base region, risetime equals falltime. If optical saturation occurs, t_F can become much larger than t_R .

PerkinElmer tests the t_R and t_F of its phototransistors at an $I_C = 1.0$ mA and with a 100 ohm load resistor in series with the detector. Phototransistors display t_R and t_F times in a range of 1 μ sec to 10 μ sec.

Selecting a Photodetector

Each application is a unique combination of circuit requirements, light intensity levels, wavelengths, operating environment, and cost considerations.

PerkinElmer offers a broad range of catalog phototransistors to help you with these design tradeoffs.

The charts presented below are intended to give some general guidelines and tradeoffs for selecting the proper detector for your application.

Size of Detector Chip

SMALL SIZE	PARAMETER	LARGE SIZE
LOWER	SENSITIVITY	HIGHER
FASTER	SPEED OF RESPONSE	SLOWER
LOWER	DARK CURRENT	HIGHER
LOWER	COST	HIGHER

Gain (H_{FE})

LOW GAIN	PARAMETER	HIGH GAIN
LOWER	SENSITIVITY	HIGHER
FASTER	SPEED OF RESPONSE	SLOWER
LOWER	DARK CURRENT	HIGHER
SMALLER	TEMP. COEF.	LARGER
LOWER	COST	HIGHER

Phototransistor Typical Characteristic Curves

PerkinElmer Optoelectronics phototransistors are intended to service a wide range of applications with reliable, versatile, and well designed devices. We offer different chip sizes, specifications, various industry standard cases, lensed or unlensed, in both hermetic and plastic packages to provide a full range of options for the design engineer. With the added benefit of favorable prices, these products should meet the needs of any design.

Dark Current vs. Temperature
(Referred To 25°C)

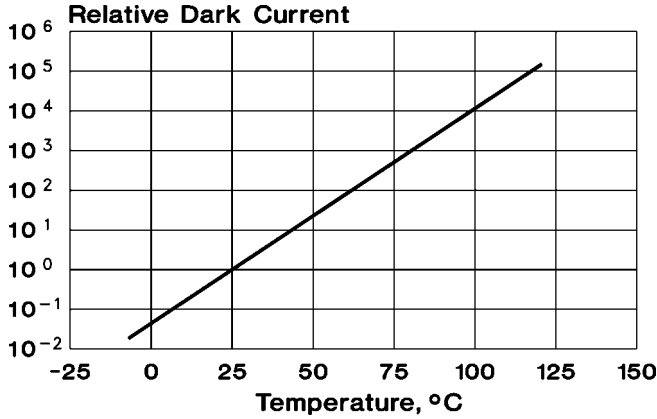

Relative Spectral Response
(Referred To Peak Response Of Clear Case)

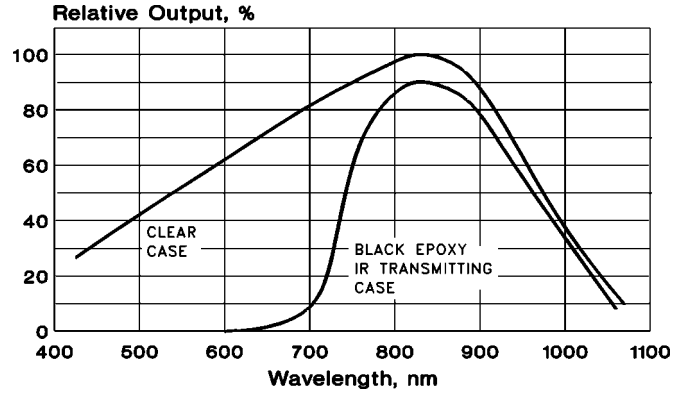

Relative Output vs. Illumination
(Normalized At 100 fc)

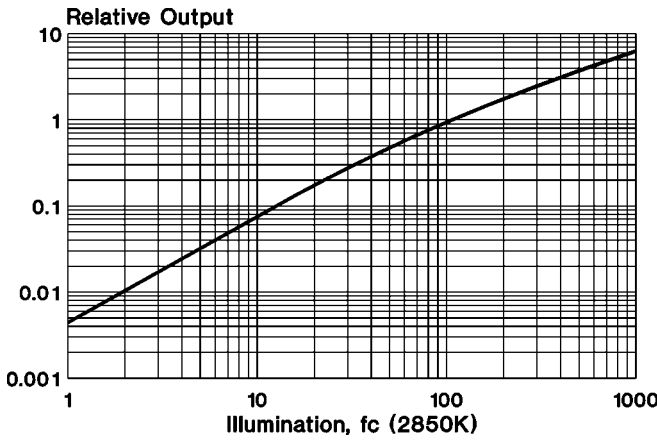

Response Time
(For 25T Type Phototransistors)

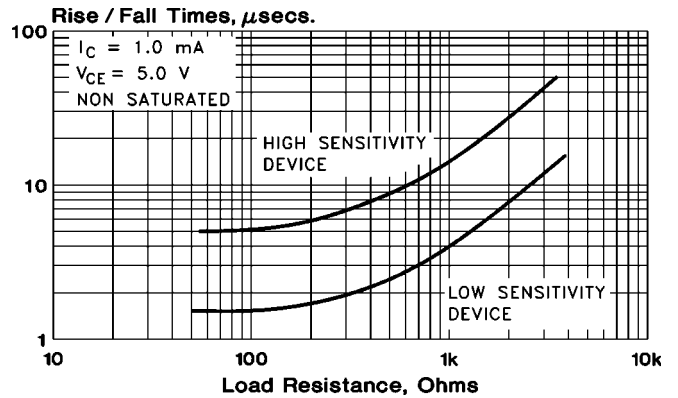

Phototransistor Typical Characteristic Curves

Response Time
(For 40T Type Phototransistors)

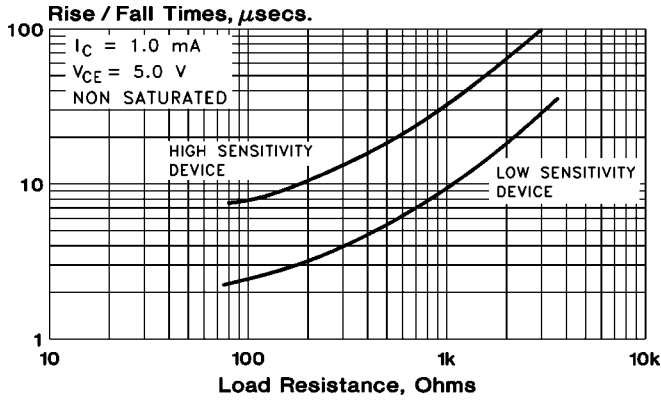

Response Time
(For 50T Type Phototransistors)

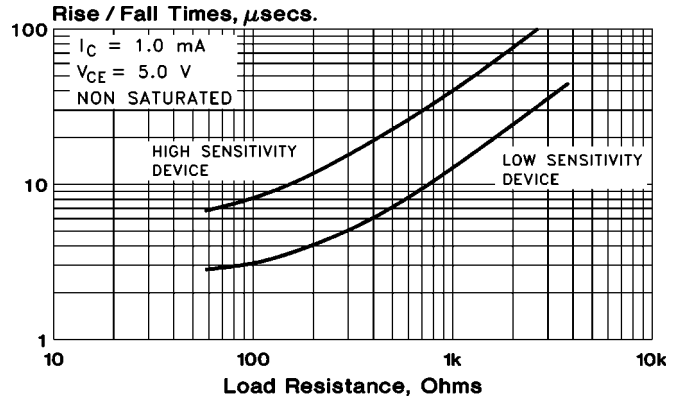

Angular Response
Coax Packages

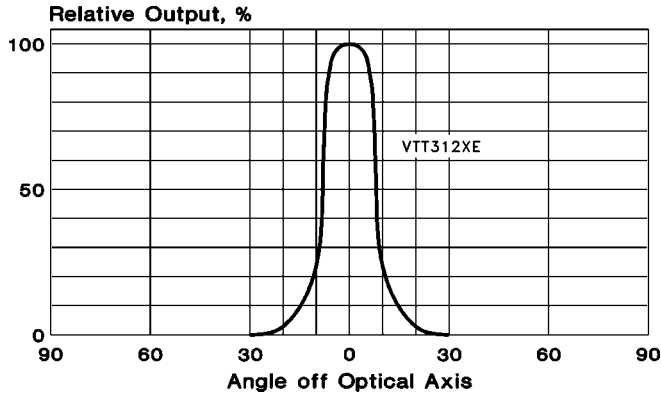

Angular Response
Molded Epoxy Packages

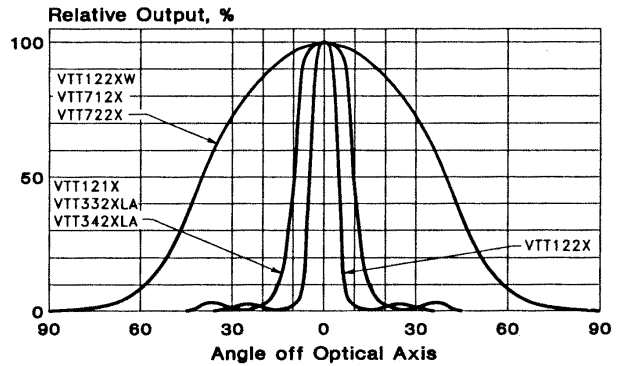

Angular Response
10-46 Packages

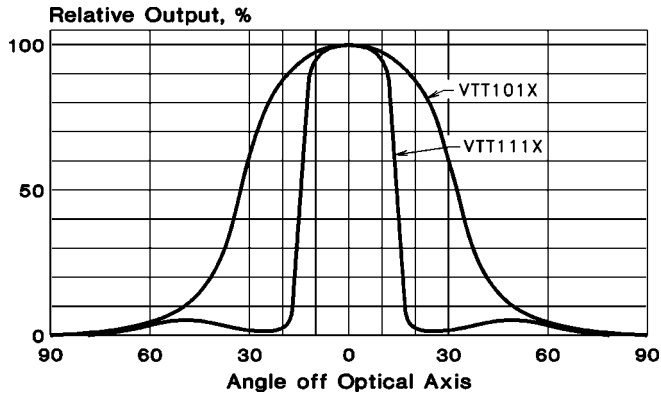

Angular Response
Ceramic Packages

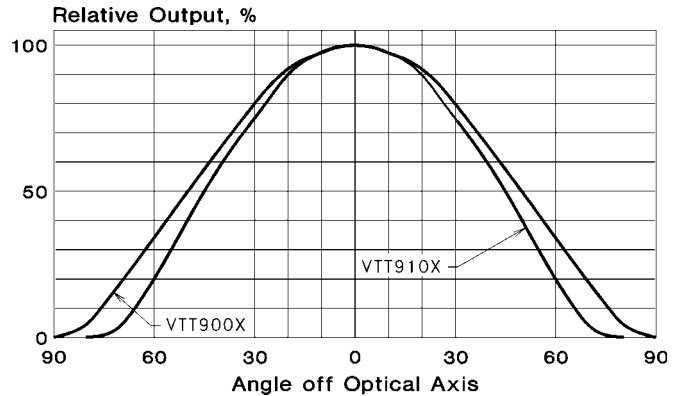

.025" NPN Phototransistors

Clear T-1 $\frac{3}{4}$ (5 mm) Plastic Package

SUNSTAR传感与控制 <http://www.sensor-ic.com/> TEL: 0755-83376549 FAX: 0755-83376182 E-MAIL: szss20@163.com

VTT1222W, 23W

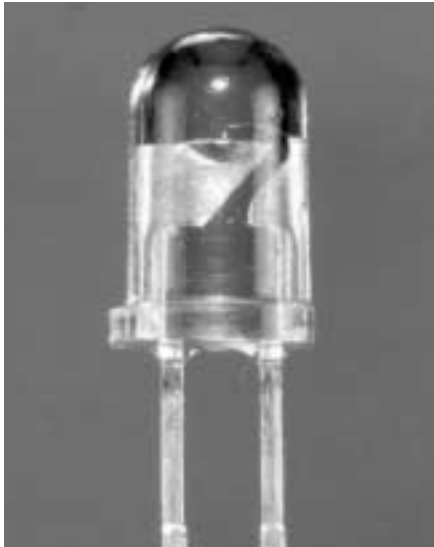

PACKAGE DIMENSIONS inch (mm)

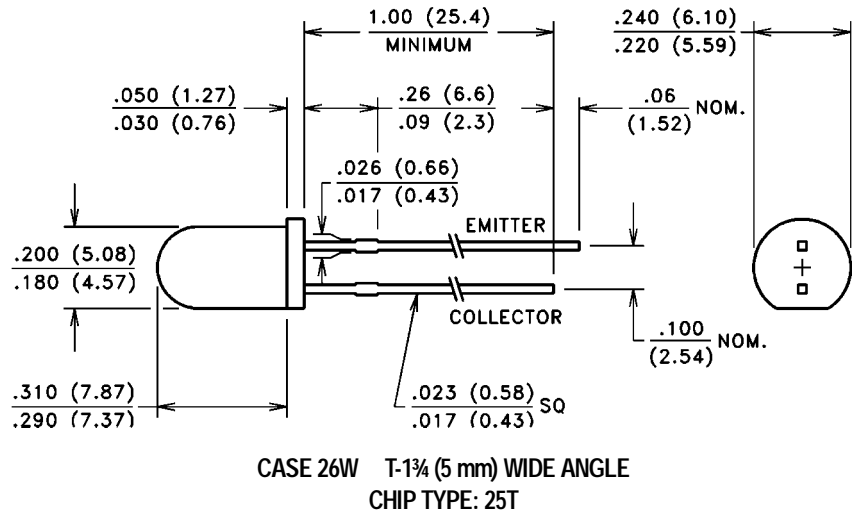

PRODUCT DESCRIPTION

A small area high speed NPN silicon phototransistor mounted in a 5 mm diameter lensed, end looking, transparent plastic package. Detectors in this series have a half power acceptance angle ($\theta_{1/2}$) of 40°. These devices are spectrally and mechanically matched to the VTE12xxW series of IREDS.

ABSOLUTE MAXIMUM RATINGS ■

(@ 25°C unless otherwise noted)

Maximum Temperatures	
Storage Temperature:	-40°C to 100°C
Operating Temperature:	-40°C to 100°C
Continuous Power Dissipation:	50 mW
Derate above 30°C:	0.71 mW/°C
Maximum Current:	25 mA
Lead Soldering Temperature:	260°C
	(1.6 mm from case, 5 sec. max.)

ELECTRO-OPTICAL CHARACTERISTICS @ 25°C (See also typical curves, pages 91-92)

Part Number ■	Light Current		Dark Current		Collector Breakdown	Emitter Breakdown	Saturation Voltage	Rise/Fall Time	Angular Response $\theta_{1/2}$	
	I_C		I_{CEO}		$V_{BR(CEO)}$	$V_{BR(ECO)}$	$V_{CE(SAT)}$	t_R/t_F		
	mA	H fc (mW/cm ²) $V_{CE} = 5.0 V$	H = 0		$I_C = 100 \mu A$ H = 0	$I_E = 100 \mu A$ H = 0	$I_C = 1.0 mA$ H = 400 fc	$I_C = 1.0 mA$ $R_L = 100 \Omega$		
	Min.	Max.	(nA) Max.	V_{CE} (Volts)	Volts, Min.	Volts, Min.	Volts, Max.	μsec , Typ.		
VTT1222W	1.9	—	100 (5)	10	20	50	6.0	0.25	2.0	$\pm 40^\circ$
VTT1223W	1.5	—	100 (5)	10	20	40	6.0	0.25	3.0	$\pm 40^\circ$

■ Refer to General Product Notes, page 2.

.025" NPN Phototransistors

Clear T-1 $\frac{3}{4}$ (5 mm) Plastic Package

VTT1225, 26, 27

SUNSTAR 传感器控制 <http://www.sensor-ic.com/> TEL: 0755-83376549 FAX: 0755-83376182 E-MAIL: szss20@163.com



PACKAGE DIMENSIONS inch (mm)

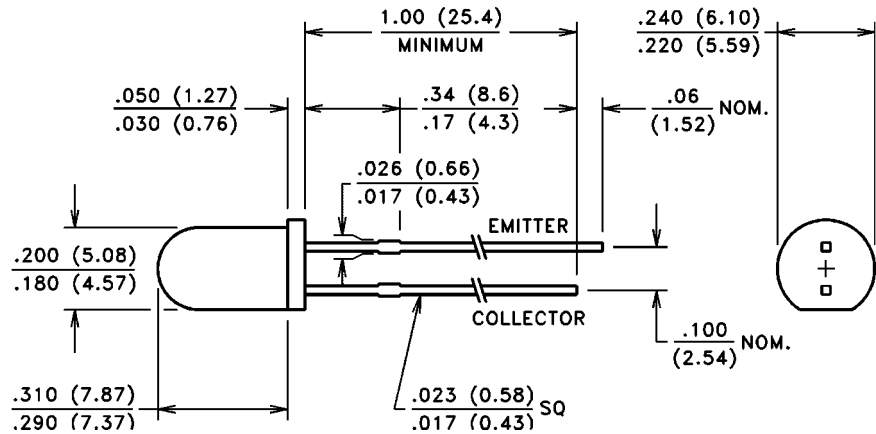

CASE 26 T-1 $\frac{3}{4}$ (5 mm)
CHIP TYPE: 25T

PRODUCT DESCRIPTION

A small area high speed NPN silicon phototransistor mounted in a 5 mm diameter lensed, end looking, transparent plastic package. Detectors in this series have a half power acceptance angle ($\theta_{1/2}$) of 5°. These devices are spectrally and mechanically matched to the VTE12xx series of IREDS.

ABSOLUTE MAXIMUM RATINGS ■

(@ 25°C unless otherwise noted)

Maximum Temperatures	
Storage Temperature:	-40°C to 100°C
Operating Temperature:	-40°C to 100°C
Continuous Power Dissipation:	50 mW
Derate above 30°C:	0.71 mW/°C
Maximum Current:	25 mA
Lead Soldering Temperature:	260°C
	(1.6 mm from case, 5 sec. max.)

ELECTRO-OPTICAL CHARACTERISTICS @ 25°C (See also typical curves, pages 91-92)

Part Number ■	Light Current		Dark Current	Collector Breakdown	Emitter Breakdown	Saturation Voltage	Rise/Fall Time	Angular Response $\theta_{1/2}$		
	I_C		I_{CEO}	$V_{BR(CEO)}$	$V_{BR(ECO)}$	$V_{CE(SAT)}$	t_R/t_F			
	mA	H fc (mW/cm ²) $V_{CE} = 5.0 V$	H = 0	$I_C = 100 \mu A$ H = 0	$I_E = 100 \mu A$ H = 0	$I_C = 1.0 mA$ H = 400 fc	$I_C = 1.0 mA$ $R_L = 100 \Omega$			
	Min.	Max.	(nA) Max.	V_{CE} (Volts)	Volts, Min.	Volts, Min.	Volts, Max.		μsec , Typ.	Typ.
VTT1225	4.0	—	100 (5)	100	10	30	5.0	0.25	1.5	$\pm 5^\circ$
VTT1226	7.5	—	100 (5)	100	10	30	5.0	0.25	3.0	$\pm 5^\circ$
VTT1227	12.0	—	100 (5)	100	10	30	5.0	0.25	4.0	$\pm 5^\circ$

■ Refer to General Product Notes, page 2.

.025" NPN Phototransistors

Clear Long T-1 (3 mm) Plastic Package

VTT3323LA, 4LA, 5LA

SUNSTAR传感与控制 <http://www.sensor-ic.com/> TEL: 0755-83376549 FAX: 0755-83376182 E-MAIL: szss20@163.com



PACKAGE DIMENSIONS inch (mm)

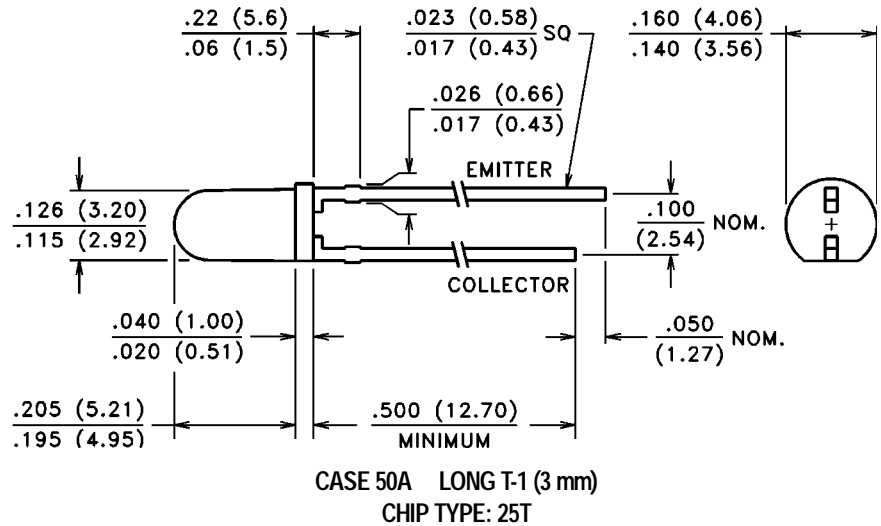

PRODUCT DESCRIPTION

A small area high speed NPN silicon phototransistor mounted in a 3 mm diameter, lensed, end looking, transparent plastic package. These devices are spectrally and mechanically matched to the VTE337xLA series of IREDS.

ABSOLUTE MAXIMUM RATINGS ■

(@ 25°C unless otherwise noted)

Maximum Temperatures	
Storage Temperature:	-40°C to 100°C
Operating Temperature:	-40°C to 100°C
Continuous Power Dissipation:	50 mW
Derate above 30°C:	0.71 mW/°C
Maximum Current:	25 mA
Lead Soldering Temperature:	260°C
	(1.6 mm from case, 5 sec. max.)

ELECTRO-OPTICAL CHARACTERISTICS @ 25°C (See also typical curves, pages 91-92)

Part Number ■	Light Current		Dark Current	Collector Breakdown	Emitter Breakdown	Saturation Voltage	Rise/Fall Time	Angular Response $\theta_{1/2}$		
	I_C		I_{CEO}	$V_{BR(CEO)}$	$V_{BR(EO)}$	$V_{CE(SAT)}$	t_R/t_F			
	mA	H fc (mW/cm ²) $V_{CE} = 5.0 V$	H = 0	$I_C = 100 \mu A$ H = 0	$I_E = 100 \mu A$ H = 0	$I_C = 1.0 mA$ H = 400 fc	$I_C = 1.0 mA$ $R_L = 100 \Omega$			
	Min.	Max.	(nA) Max.	V_{CE} (Volts)	Volts, Min.	Volts, Min.	Volts, Max.		μsec , Typ.	Typ.
VTT3323LA	2.0	—	20 (1)	100	10	30	5.0	0.25	3.0	±10°
VTT3324LA	4.0	—	20 (1)	100	10	30	5.0	0.25	4.0	±10°
VTT3325LA	6.0	—	20 (1)	100	10	30	5.0	0.25	5.0	±10°

■ Refer to General Product Notes, page 2.

.025" NPN Phototransistors

IRT Long T-1 (3 mm) Plastic Package

VTT3423LA, 4LA, 5LA

SUNSTAR 传感器控制 <http://www.sensor-ic.com/> TEL: 0755-83376549 FAX: 0755-83376182 E-MAIL: szss20@163.com

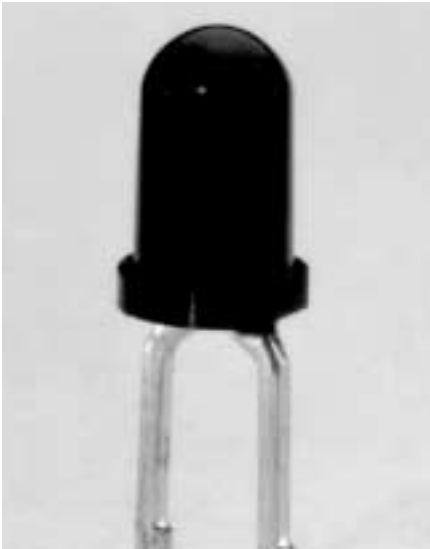

PACKAGE DIMENSIONS inch (mm)

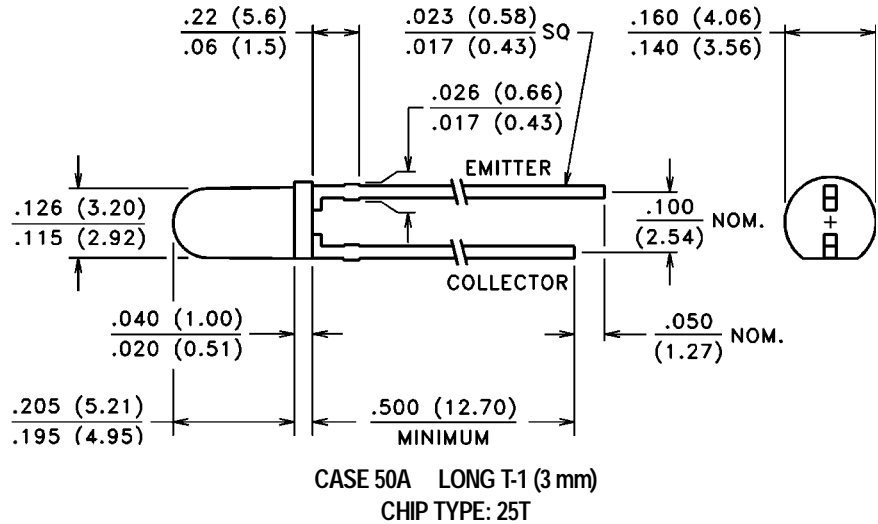

PRODUCT DESCRIPTION

A small area high speed NPN silicon phototransistor in a 3 mm diameter, lensed plastic package. The package material transmits infrared and blocks visible light. These devices are spectrally and mechanically matched to the VTE33xxLA series of IREDS.

ABSOLUTE MAXIMUM RATINGS ■

(@ 25°C unless otherwise noted)

Maximum Temperatures	
Storage Temperature:	-40°C to 100°C
Operating Temperature:	-40°C to 100°C
Continuous Power Dissipation:	50 mW
Derate above 30°C:	0.71 mW/°C
Maximum Current:	25 mA
Lead Soldering Temperature:	260°C
	(1.6 mm from case, 5 sec. max.)

ELECTRO-OPTICAL CHARACTERISTICS @ 25°C (See also typical curves, pages 91-92)

Part Number ■	Light Current		Dark Current		Collector Breakdown	Emitter Breakdown	Saturation Voltage	Rise/Fall Time	Angular Response $\theta_{1/2}$	
	I_C		I_{CEO}		$V_{BR(CEO)}$	$V_{BR(ECO)}$	$V_{CE(SAT)}$	t_R/t_F		
	mA	H fc (mW/cm ²) $V_{CE} = 5.0 V$	H = 0		$I_C = 100 \mu A$ H = 0	$I_E = 100 \mu A$ H = 0	$I_C = 1.0 mA$ H = 400 fc	$I_C = 1.0 mA$ $R_L = 100 \Omega$		
	Min.	Max.	(nA) Max.	V_{CE} (Volts)	Volts, Min.	Volts, Min.	Volts, Max.	μsec , Typ.		
VTT3423LA	1.0	—	20 (1)	100	10	30	5.0	0.25	3.0	$\pm 10^\circ$
VTT3424LA	2.0	—	20 (1)	100	10	30	5.0	0.25	4.0	$\pm 10^\circ$
VTT3425LA	3.0	—	20 (1)	100	10	30	5.0	0.25	5.0	$\pm 10^\circ$

■ Refer to General Product Notes, page 2.

.025" NPN Phototransistors

Molded Lensed Lateral Package

SUNSTAR传感与控制 <http://www.sensor-ic.com/> TEL: 0755-83376549 FAX: 0755-83376182 E-MAIL: szss20@163.com

VTT7122, 7123, 7125

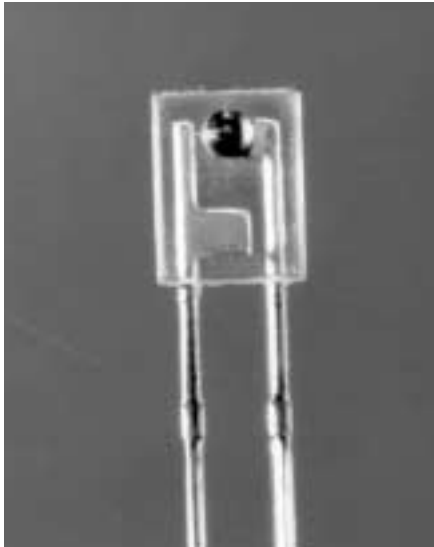

PACKAGE DIMENSIONS inch (mm)

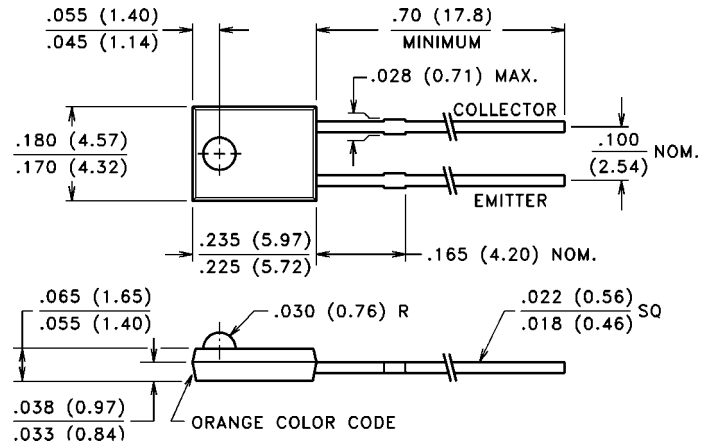

CASE 7 LATERAL
CHIP TYPE: 25T

PRODUCT DESCRIPTION

A small area high speed NPN silicon phototransistor mounted in a lensed, side looking, transparent plastic, transfer molded package. These devices are spectrally and mechanically matched to the VTE717x series of IREDS.

ABSOLUTE MAXIMUM RATINGS ■

(@ 25°C unless otherwise noted)

Maximum Temperatures	
Storage Temperature:	-40°C to 85°C
Operating Temperature:	-40°C to 85°C
Continuous Power Dissipation:	50 mW
Derate above 30°C:	0.91 mW/°C
Maximum Current:	25 mA
Lead Soldering Temperature:	260°C
	(1.6 mm from case, 5 sec. max.)

ELECTRO-OPTICAL CHARACTERISTICS @ 25°C (See also typical curves, pages 91-92)

Part Number ■	Light Current		Dark Current	Collector Breakdown	Emitter Breakdown	Saturation Voltage	Rise/Fall Time	Angular Response $\theta_{1/2}$		
	I_C		I_{CEO}	$V_{BR(CEO)}$	$V_{BR(ECO)}$	$V_{CE(SAT)}$	t_R/t_F			
	mA	H fc (mW/cm ²) $V_{CE} = 5.0 V$	H = 0	$I_C = 100 \mu A$ H = 0	$I_E = 100 \mu A$ H = 0	$I_C = 1.0 mA$ H = 400 fc	$I_C = 1.0 mA$ $R_L = 100 \Omega$			
	Min.	Max.	(nA) Max.	V_{CE} (Volts)	Volts, Min.	Volts, Min.	Volts, Max.		μsec , Typ.	Typ.
VTT7122	1.0	—	100 (5)	100	10	30	5.0	0.25	2.0	$\pm 36^\circ$
VTT7123	2.0	—	100 (5)	100	10	30	5.0	0.25	2.0	$\pm 36^\circ$
VTT7125	4.5	—	100 (5)	100	10	30	5.0	0.25	2.0	$\pm 36^\circ$

■ Refer to General Product Notes, page 2.

.025" NPN Phototransistors

IRT Molded Lensed Lateral Package

VTT7222, 7223, 7225

SUNSTAR 传感器控制 <http://www.sensor-ic.com/> TEL: 0755-83376549 FAX: 0755-83376182 E-MAIL: szss20@163.com

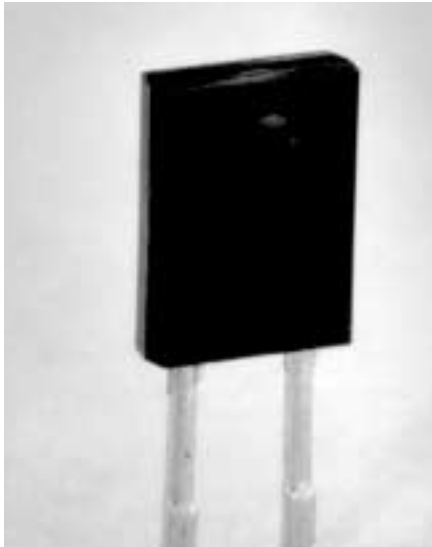

PACKAGE DIMENSIONS inch (mm)

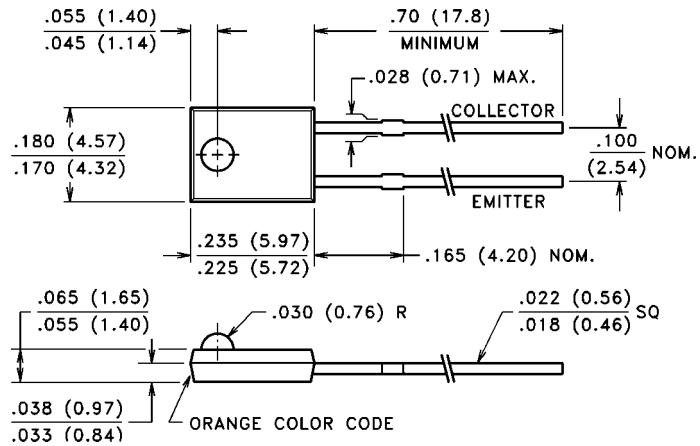

CASE 7 LATERAL
CHIP TYPE: 25T

PRODUCT DESCRIPTION

A small area high speed NPN silicon phototransistor mounted in a 3 mm diameter, lensed, end looking, plastic package. The package material transmits infrared and blocks visible light. These devices are spectrally and mechanically matched to the VTE717x series of IREDS.

ABSOLUTE MAXIMUM RATINGS ■

(@ 25°C unless otherwise noted)

Maximum Temperatures	
Storage Temperature:	-40°C to 85°C
Operating Temperature:	-40°C to 85°C
Continuous Power Dissipation:	50 mW
Derate above 30°C:	0.71 mW/°C
Maximum Current:	25 mA
Lead Soldering Temperature:	260°C
	(1.6 mm from case, 5 sec. max.)

ELECTRO-OPTICAL CHARACTERISTICS @ 25°C (See also typical curves, pages 91-92).

Part Number ■	Light Current		Dark Current	Collector Breakdown	Emitter Breakdown	Saturation Voltage	Rise/Fall Time	Angular Response $\theta_{1/2}$		
	I_C		I_{CEO}	$V_{BR(CEO)}$	$V_{BR(ECO)}$	$V_{CE(SAT)}$	t_R/t_F			
	mA	H fc (mW/cm ²) $V_{CE} = 5.0$ V	H = 0	$I_C = 100 \mu A$ H = 0	$I_E = 100 \mu A$ H = 0	$I_C = 1.0$ mA H = 400 fc	$I_C = 1.0$ mA $R_L = 100 \Omega$			
	Min.	Max.	(nA) Max.	V_{CE} (Volts)	Volts, Min.	Volts, Min.	Volts, Max.		μ sec, Typ.	Typ.
VTT7222	0.9	—	100 (5)	100	10	30	5.0	0.25	2.0	$\pm 36^\circ$
VTT7223	1.8	—	100 (5)	100	10	30	5.0	0.25	2.0	$\pm 36^\circ$
VTT7225	4.0	—	100 (5)	100	10	30	5.0	0.25	4.0	$\pm 36^\circ$

■ Refer to General Product Notes, page 2.

.040" NPN Phototransistors

Clear T-1 $\frac{3}{4}$ (5 mm) Plastic Package

VTT1212, 1214

SUNSTAR传感与控制 <http://www.sensor-ic.com/> TEL: 0755-83376549 FAX: 0755-83376182 E-MAIL: szss20@163.com



PACKAGE DIMENSIONS inch (mm)

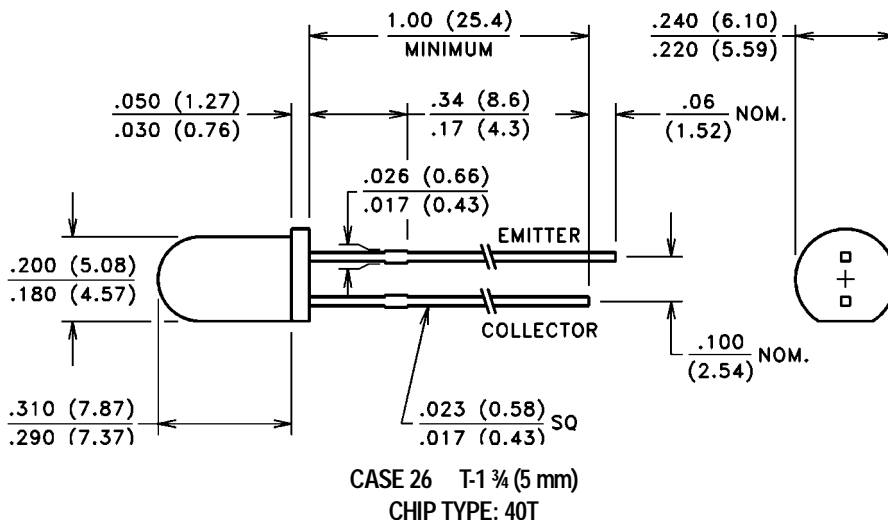

PRODUCT DESCRIPTION

A medium area high speed NPN silicon phototransistor possessing excellent sensitivity and good speed mounted in a lensed, end looking, transparent plastic package. These devices are spectrally and mechanically matched to the VTE12xx series of IREDS.

ABSOLUTE MAXIMUM RATINGS ■

(@ 25°C unless otherwise noted)

Maximum Temperatures	
Storage Temperature:	-40°C to 100°C
Operating Temperature:	-40°C to 100°C
Continuous Power Dissipation:	50 mW
Derate above 30°C:	0.71 mW/°C
Maximum Current:	25 mA
Lead Soldering Temperature:	260°C
	(1.6 mm from case, 5 sec. max.)

ELECTRO-OPTICAL CHARACTERISTICS @ 25°C (See also typical curves, pages (91-92))

Part Number ■	Light Current		Dark Current	Collector Breakdown	Emitter Breakdown	Saturation Voltage	Rise/Fall Time	Angular Response $\theta_{1/2}$		
	I_C		I_{CEO}	$V_{BR(CEO)}$	$V_{BR(EO)}$	$V_{CE(SAT)}$	t_R/t_F			
	mA	H fc (mW/cm ²) $V_{CE} = 5.0 V$	H = 0	$I_C = 100 \mu A$ H = 0	$I_E = 100 \mu A$ H = 0	$I_C = 1.0 mA$ H = 400 fc	$I_C = 1.0 mA$ $R_L = 100 \Omega$			
	Min.	Max.	(nA) Max.	V_{CE} (Volts)	Volts, Min.	Volts, Min.	Volts, Max.	$\mu sec, Typ.$	Typ.	
VTT1212	2.0	—	20 (1)	100	10	30	5.0	0.25	4.0	$\pm 10^\circ$
VTT1214	4.0	—	20 (1)	100	10	30	5.0	0.25	6.0	$\pm 10^\circ$

■ Refer to General Product Notes, page 2.

.040" NPN Phototransistors

Clear Epoxy TO-106 Ceramic Package

VTT9002, 9003

SUNSTAR 传感器控制 <http://www.sensor-ic.com/> TEL: 0755-83376549 FAX: 0755-83376182 E-MAIL: szss20@163.com

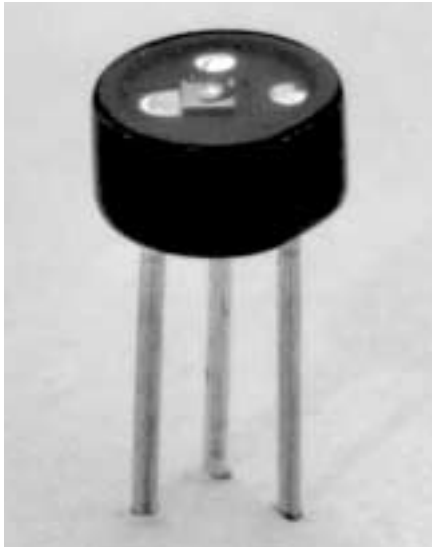

PACKAGE DIMENSIONS inch (mm)

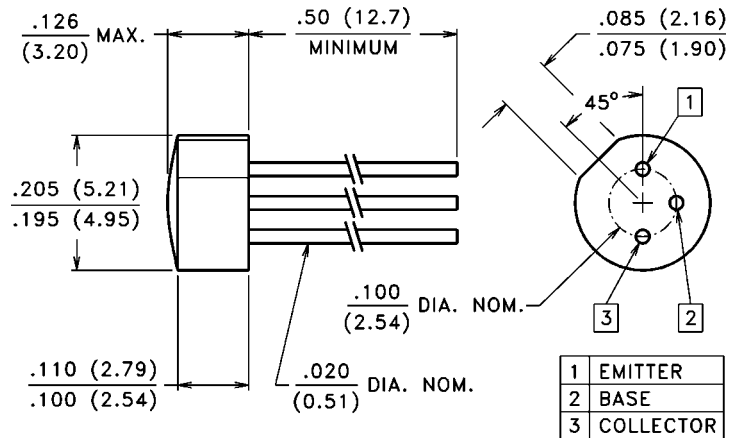

CASE 8 TO-106 (FLAT)
CHIP TYPE: 40T

PRODUCT DESCRIPTION

A medium area high sensitivity NPN silicon phototransistor in a recessed TO-106 ceramic package. The chip is protected with a layer of clear epoxy. The base connection is brought out allowing conventional transistor biasing. These devices are spectrally matched to any of PerkinElmer IREDs.

ABSOLUTE MAXIMUM RATINGS ■

(@ 25°C unless otherwise noted)

Maximum Temperatures	
Storage Temperature:	-20°C to 70°C
Operating Temperature:	-20°C to 70°C
Continuous Power Dissipation:	100 mW
Derate above 30°C:	2.5 mW/°C
Maximum Current:	25 mA
Lead Soldering Temperature:	260°C
	(1.6 mm from case, 5 sec. max.)

ELECTRO-OPTICAL CHARACTERISTICS @ 25°C (See also typical curves, pages 91-92)

Part Number	Light Current		Dark Current	Collector Breakdown	Emitter Breakdown	Saturation Voltage	Rise/Fall Time	Angular Response $\theta_{1/2}$		
	I_C		I_{CEO}	$V_{BR(CEO)}$	$V_{BR(ECO)}$	$V_{CE(SAT)}$	t_R/t_F			
	mA	H	H = 0	$I_C = 100 \mu A$	$I_E = 100 \mu A$	$I_C = 1.0 mA$	$I_C = 1.0 mA$			
	Min.	Max.	(nA) Max.	V_{CE} (Volts)	Volts, Min.	Volts, Min.	Volts, Max.		$R_L = 100 \Omega$	
VTT9002	2.0	—	100 (5)	100	10	30	6.0	0.55	4.0	$\pm 50^\circ$
VTT9003	5.0	—	100 (5)	100	10	30	6.0	0.55	6.0	$\pm 50^\circ$

■ Refer to General Product Notes, page 2.

.040" NPN Phototransistors

Epoxy Lensed TO-106 Ceramic Package

VTT9102, 9103

SUNSTAR 传感与控制 <http://www.sensor-ic.com/> TEL: 0755-83376549 FAX: 0755-83376182 E-MAIL: szss20@163.com

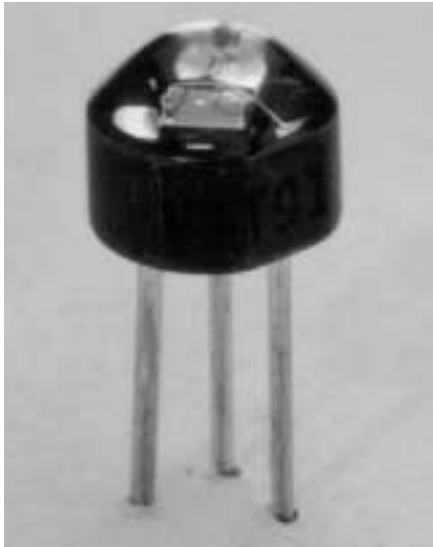

PACKAGE DIMENSIONS inch (mm)

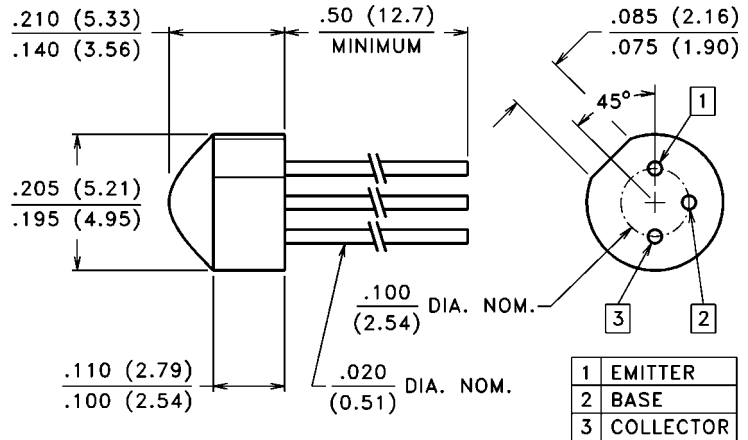

CASE 9 TO-106 (LENSED)
CHIP TYPE: 40T

PRODUCT DESCRIPTION

A medium area high sensitivity NPN silicon phototransistor in a recessed TO-106 ceramic package. The chip is protected with a lens of clear epoxy. The base connection is brought out allowing conventional transistor biasing. These devices are spectrally matched to any of PerkinElmer IREDS.

ABSOLUTE MAXIMUM RATINGS ■

(@ 25°C unless otherwise noted)

Maximum Temperatures	
Storage Temperature:	-20°C to 70°C
Operating Temperature:	-20°C to 70°C
Continuous Power Dissipation:	100 mW
Derate above 30°C:	2.5 mW/°C
Maximum Current:	50 mA
Lead Soldering Temperature:	260°C
	(1.6 mm from case, 5 sec. max.)

ELECTRO-OPTICAL CHARACTERISTICS @ 25°C (See also typical curves, pages 91-92)

Part Number	Light Current		Dark Current		Collector Breakdown	Emitter Breakdown	Saturation Voltage	Rise/Fall Time	Angular Response $\theta_{1/2}$	
	I_C		I_{CEO}		$V_{BR(CEO)}$	$V_{BR(ECO)}$	$V_{CE(SAT)}$	t_R/t_F		
	mA	H fc (mW/cm ²) $V_{CE} = 5.0 V$	H = 0		$I_C = 100 \mu A$ H = 0	$I_E = 100 \mu A$ H = 0	$I_C = 1.0 mA$ H = 400 fc	$I_C = 1.0 mA$ $R_L = 100 \Omega$		
	Min.	Max.	(nA) Max.	V_{CE} (Volts)	Volts, Min.	Volts, Min.	Volts, Max.	μsec , Typ.		
VTT9102	6.0	—	100 (5)	100	5	30	4.0	0.55	6.0	$\pm 42^\circ$
VTT9103	13.0	—	100 (5)	100	5	30	4.0	0.55	10.0	$\pm 42^\circ$

■ Refer to General Product Notes, page 2.

.050" NPN Phototransistors

TO-46 Flat Window Package

VTT1015, 16, 17

SUNSTAR 传感器控制 <http://www.sensor-ic.com/> TEL: 0755-83376549 FAX: 0755-83376182 E-MAIL: szss20@163.com



PACKAGE DIMENSIONS inch (mm)

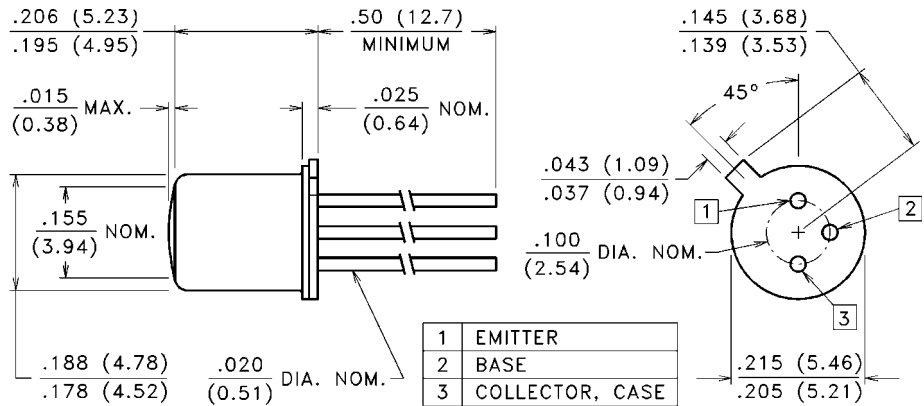

CASE 1 TO-46 (FLAT WINDOW)
CHIP TYPE: 50T

PRODUCT DESCRIPTION

A large area high sensitivity NPN silicon phototransistor in a flat lensed, hermetically sealed, TO-46 package. The hermetic package offers superior protection from hostile environments. The base connection is brought out allowing conventional transistor biasing. These devices are spectrally matched to the VTE10xx series of IREDS.

ABSOLUTE MAXIMUM RATINGS ■

(@ 25°C unless otherwise noted)

Maximum Temperatures	
Storage Temperature:	-40°C to 110°C
Operating Temperature:	-40°C to 110°C
Continuous Power Dissipation:	250 mW
Derate above 30°C:	3.12 mW/°C
Maximum Current:	200 mA
Lead Soldering Temperature:	260°C
	(1.6 mm from case, 5 sec. max.)

ELECTRO-OPTICAL CHARACTERISTICS @ 25°C (See also typical curves, pages 91-92)

Part Number ■	Light Current		Dark Current	Collector Breakdown	Emitter Breakdown	Saturation Voltage	Rise/Fall Time	Angular Response $\theta_{1/2}$		
	I_C		I_{CEO}	$V_{BR(CEO)}$	$V_{BR(ECO)}$	$V_{CE(SAT)}$	t_R/t_F			
	mA	H fc (mW/cm ²) $V_{CE} = 5.0 V$	H = 0	$I_C = 100 \mu A$ H = 0	$I_E = 100 \mu A$ H = 0	$I_C = 1.0 mA$ H = 400 fc	$I_C = 1.0 mA$ $R_L = 100 \Omega$			
	Min.	Max.	(nA) Max.	V_{CE} (Volts)	Volts, Min.	Volts, Min.	Volts, Max.		μsec , Typ.	Typ.
VTT1015	0.4	—	100 (5)	25	20	40	6.0	0.40	5.0	$\pm 35^\circ$
VTT1016	1.0	—	100 (5)	25	20	30	6.0	0.40	5.0	$\pm 35^\circ$
VTT1017	2.5	—	100 (5)	25	10	20	4.0	0.40	8.0	$\pm 35^\circ$

■ Refer to General Product Notes, page 2.

.050" NPN Phototransistors

SUNSTAR传感与控制 <http://www.sensor-ic.com/> TEL: 0755-83376549 FAX: 0755-83376182 E-MAIL: szss20@163.com

TO-46 Lensed Package

VTT1115, 16, 17



PACKAGE DIMENSIONS inch (mm)

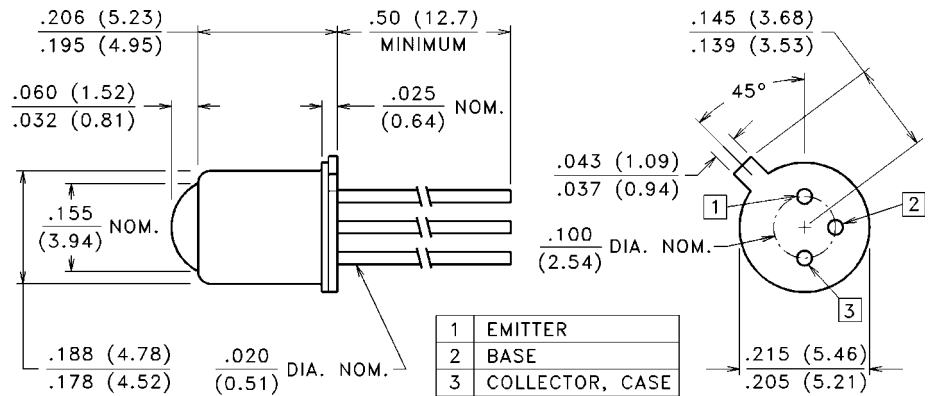

CASE 3 TO-46 HERMETIC (LENSED)
CHIP TYPE: 50T

PRODUCT DESCRIPTION

A large area high sensitivity NPN silicon phototransistor in a lensed, hermetically sealed, TO-46 package. The hermetic package offers superior protection from hostile environments. The base connection is brought out allowing conventional transistor biasing. These devices are spectrally matched to the VTE11xx series of IREDS.

ABSOLUTE MAXIMUM RATINGS ■

(@ 25°C unless otherwise noted)

Maximum Temperatures	
Storage Temperature:	-40°C to 110°C
Operating Temperature:	-40°C to 110°C
Continuous Power Dissipation:	250 mW
Derate above 30°C:	3.12 mW/°C
Maximum Current:	200 mA
Lead Soldering Temperature:	260°C
	(1.6 mm from case, 5 sec. max.)

ELECTRO-OPTICAL CHARACTERISTICS @ 25°C (See also typical curves, pages 91-92)

Part Number ■	Light Current			Dark Current		Collector Breakdown	Emitter Breakdown	Saturation Voltage	Rise/Fall Time	Angular Response $\theta_{1/2}$ Typ.
	I_C			I_{CEO}		$V_{BR(CEO)}$	$V_{BR(ECO)}$	$V_{CE(SAT)}$	t_R/t_F	
	mA		H fc (mW/cm ²) $V_{CE} = 5.0 V$	H = 0		$I_C = 100 \mu A$ H = 0	$I_E = 100 \mu A$ H = 0	$I_C = 1.0 mA$ H = 400 fc	$I_C = 1.0 mA$ $R_L = 100 \Omega$	
	Min.	Max.		(nA) Max.	V_{CE} (Volts)	Volts, Min.	Volts, Min.	Volts, Max.	$\mu sec, Typ.$	
VTT1115	1.0	—	20 (1)	100	10	30	6.0	0.40	5.0	$\pm 15^\circ$
VTT1116	2.0	—	20 (1)	100	10	30	4.0	0.40	8.0	$\pm 15^\circ$
VTT1117	4.0	—	20 (1)	100	10	30	4.0	0.40	8.0	$\pm 15^\circ$

■ Refer to General Product Notes, page 2.

What is an LED? What is an IRED?

LEDs are solid state p-n junction devices which emit light when forward biased. An LED is a Light Emitting Diode, a generic term. An IRED is an Infrared Emitting Diode, a term specifically applied to PerkinElmer IR emitters. Unlike incandescent lamps which emit light over a very broad range of wavelengths, LEDs emit light over such a narrow bandwidth that they appear to be emitting a single "color". Their small size, long operating lifetimes, low power consumption, compatibility with solid state drive circuitry, and relatively low cost, make LEDs the preferred light source in many applications.

LEDs are made from a wide range of semiconductor materials. The emitted peak wavelength depends on the semiconductor material chosen and how it is processed. LEDs can be made which emit in the visible or near infrared part of the spectrum.

LED TYPE	COLOR	λ_p
SiC	BLUE	500 nm
GaP	GREEN	569 nm
GaAsP/GaP	YELLOW	585 nm
GaAsP/GaP	ORANGE	635 nm
GaAsP/GaAs	RED	655 nm
AlGaAs	RED	660 nm
GaP/GaP	RED	697 nm
GaAlAs	INFRARED	820 nm
GaAlAs	INFRARED	880 nm
GaAs	INFRARED	940 nm
GaAlAsInP ALLOYS	INFRARED	1300-1500 nm

The P-N junction is formed by doping one region of the material with donor atoms and the adjacent region with acceptor atoms. Like all P-N junction devices, LEDs exhibit the familiar diode current-voltage characteristics. LEDs emit light only when they are biased in the forward direction. Under forward biased conditions carriers are given

enough energy to overcome the potential barrier existing at the junction. After crossing the junction these carriers will recombine. A percentage of the carriers will recombine by a radiative process in which the hole-electron recombination energy is released as a photon of light. The remaining carriers recombine by a non radiative process and give up their energy in the form of heat. The amount of light generated, or power output of the LED, varies almost linearly with forward current. Doubling the forward current approximately doubles the power output.

Physically, most LED chips resemble a cube with a metallized bottom surface and a top metal contact. Some visible LED dice are planar processed with buried junction. The majority of high efficiency IRED chips have P-N junctions which extend out to the four sides of the chip. Since injected carrier recombination takes place within a few diffusion lengths of the junction, the light produced by the IRED is generated in this region. Once generated, the light travels out in all directions. Thus, light is not only emitted from the top surface of the chip but also from the sides. As the light travels through the chip some is reabsorbed. Light that strikes the LED chip surface at an angle greater than the critical angle of the dielectric interface is internally reflected. Only that light that exits the LED chip is useful. The packaging used to house the LED chip serves three functions; to protect the chip and its lead wire(s) from hostile environments, to increase the percentage of photons that can escape from the chip to the outside world, and to "focus" the light through the use of incorporated lenses and reflectors.

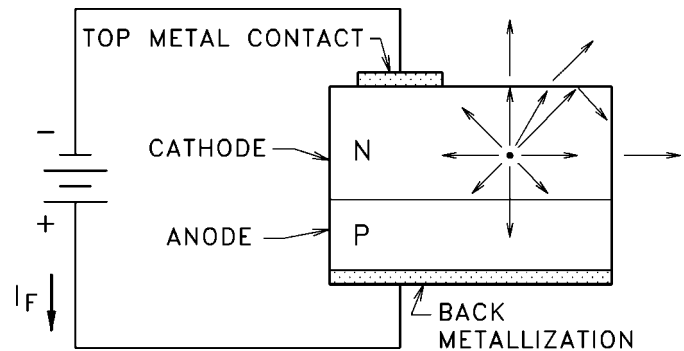

"N" on "P" 880 nm GaAlAs IR emitting diode (IRED)

Characteristics of IREDs

Measurement of Power Output

It is standard industry practice to characterize the output of IREDs in terms of power output. Since the amount of light an IRED generates depends on the value of the forward drive current (I_F), the power output is always stated for a given value of current. Also, the ambient temperature must be specified inasmuch as the radiant power decreases with increasing temperature, power decreases with increasing temperature, typically $-0.9\%/^{\circ}\text{C}$.

The following two methods are used to measure light power output.

Total Power (P_O)

This method involves collecting and measuring the total amount of light emitted from the IRED regardless of the direction. This measurement is usually done by using an integrating sphere or by placing a very large area detector directly in front of the IRED so that all light emitted in the forward direction is collected. The total output power is measured in units of watts.

The total power method ignores the effect of the beam pattern produced by the IRED package. It cannot predict how much light will strike an object positioned some distance in front of the IRED. This information is vital for design calculations in many applications. However, total output power measurement is repeatable and quite useful when trying to compare the relative performance of devices in the same type of package.

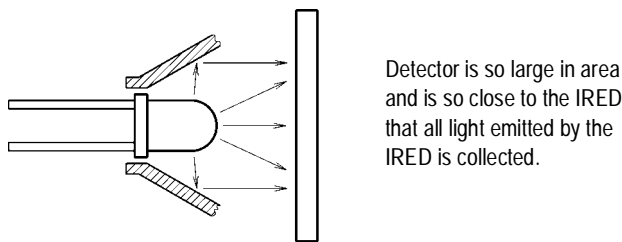

Detector is so large in area and is so close to the IRED that all light emitted by the IRED is collected.

DETECTOR

Measuring Total Power - All Light is Collected

On Axis Power (P_A)

This method characterizes the IRED in terms of axial intensity. Many practical applications require knowledge of what percentage of IR power emitted is incident upon a detector located at some distance in

front of the IRED. In order to achieve repeatable and meaningful measurement of this parameter it is necessary that the distance from the IRED to the detector and the active area of the detector be specified. This is because the radiation pattern observed for many IREDs is dependent on the distance from the IRED.

For many of its emitters PerkinElmer Optoelectronics states a minimum irradiance (E_e), which is the average power density in milliwatts per square centimeter (mw/cm^2) incident onto a surface of diameter (D) at a distance (d). The irradiance will in general not be uniform over this whole surface, and may be more or less intense on the optical axis. Irradiance at other distances may be determined from the graphs showing irradiance versus distance.

The on-axis power can also be stated as a radiant intensity (I_e) which is the average power per unit of solid angle expressed in units of milliwatts per steradian (mW/sr). To calculate the irradiance at any distance the following formula is applicable.

$$E_e = I_e/d^2 \text{ (mW}/\text{cm}^2\text{)}$$

where:

$$I_e = \text{radiant intensity (mW}/\text{sr})$$

$$d = \text{distance (cm)}$$

However, it should be noted that the IRED cannot be treated as a point source when the spacing between the IRED and receiver is small, less than ten times the IRED package diameter. Attempts to use the inverse square law can lead to serious errors when the detector is close to the IRED. Actual measurements should be used in this situation.

For IREDs of any particular package type there is a direct relationship between all three methods used for specifying power output. However, imperfect physical packages and optical aberrations prevent perfect correlation.

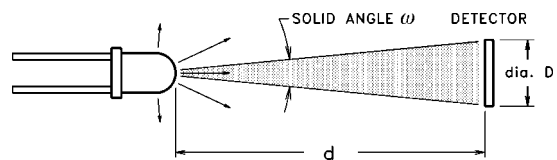

Detector or area (A) is located at specified distance (d) in front of the IRED being measured.

Measuring On-Axis Power

Characteristics of IREDs

Efficiency vs. Drive Current

As mentioned in the section *What is an LED? What is an IRED?*, once injected carriers cross the junction they can recombine by a radiative process which produces light or by a nonradiative process which produces heat. The ratio between these two processes is dependent on the current density (Amps/cm² of junction area).

At low current densities (1A/cm²) the nonradiative processes dominate and very little light is generated. As the current density is increased the radiative mechanisms increase in efficiency so that a larger and larger percentage of the forward current will contribute to the generation of light. At sufficient current densities, the percentage of forward current which produces light is almost a constant. For an IRED of "average" junction area (0.015" x 0.015") this region of linear operation is in the range of approximately 2 mA to 100 mA. Also, at high forward drive currents the junction temperature of the chip increases due to significant power dissipation. This rise in temperature results in a decrease in the radiative recombination efficiency. As the current density is further increased, internal series resistance effects will also tend to reduce the light generating efficiency of the IRED.

Light Output Degradation

In normal operation, the amount of light produced by an IRED will gradually decrease with time. The rate of decrease depends on the temperature and the current density. IREDs driven at low forward currents at room temperature ambient will degrade more slowly than IREDs driven at higher forward drive currents and at elevated temperatures. Typical degradation data is presented in the data sheet section.

Light output degradation is caused by stress placed on the IRED chip, be it mechanical, thermal or electrical. Stress causes defects in the chip to propagate along the planes of the chip's crystalline structure. These defects in the crystalline structure, called dark line defects, increase the percentage of non radiative recombinations. Forward biasing the IRED provides energy which aids in the formation and propagation of these defects. The designer using IREDs must address the light output degradation with time characteristic by including adequate degradation margins in his design so that it will continue to function adequately to the end of the design life.

Peak Spectral Wavelength (λ_p)

IREDs are commonly considered to emit monochromatic light, or light of one color. In fact, they emit light over a narrow band of wavelengths, typically less than 100 nm.

The wavelength at which the greatest amount of light is generated is called the peak wavelength, λ_p . It is determined by the energy bandgap of the semiconductor material used and the type of dopants incorporated into the IRED. The peak wavelength is a function of temperature. As the temperature increases, λ_p shifts towards longer wavelengths (typically 0.2 nm/°C).

Forward Voltage (V_F)

The current-voltage characteristics of IREDs, like any other PN junction device, obeys the standard diode equation.

$$I_F = I_0 [e^{qV_F/nKT} - 1]$$

V_F is the voltage drop across the IRED when it is forward biased at a specific current, I_F . It is important to note that V_F is a function of temperature, decreasing as temperature increases. Plots of V_F vs. I_F as a function of temperature are included in the data sheet section.

Reverse Breakdown Voltage (V_{BR})

This is the maximum reverse voltage that can safely be applied across the IRED before breakdown occurs at the junction. The IRED should never be exposed to V_{BR} even for a short period of time since permanent damage can occur. PerkinElmer IREDs are tested to a reverse voltage specification of 5V minimum.

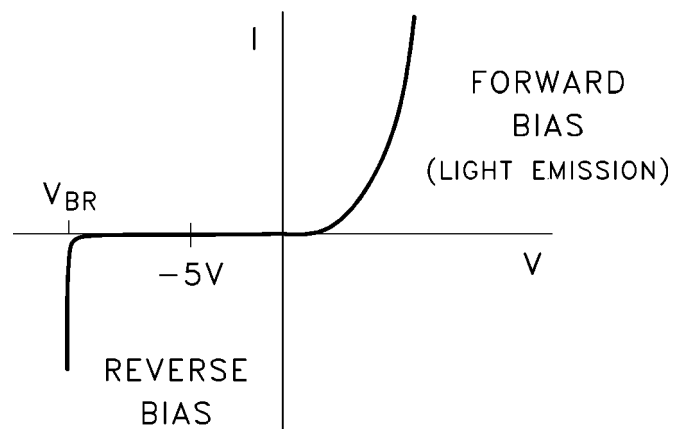

Characteristics of IREDs

Power Dissipation

Current flow through an IRED is accompanied by a voltage drop across the device. The power dissipated (power = current x voltage) causes a rise in the junction temperature rise is a decrease in the light output of the IRED (approximately -0.9%/°C). If the junction temperature becomes too high, permanent damage to the IRED will result. The maximum power dissipation rating of a semiconductor device defines that operating region where overheating can damage the device.

In any practical application, the maximum power dissipation depends on: ambient temperature, maximum (safe) junction temperature, the type of IRED package, how the IRED package is mounted, and the exact electrical drive current parameters.

While the IRED chip generates heat, its packaging serves to remove this heat out into the environment. The package's ability to dissipate heat depends not only on its design and construction but also varies from a maximum, if an efficient infinite heat sink is used, to a minimum, for the case where no heat sink is present.

The thermal impedance rating of the package quantifies the package's ability to get rid of the heat generated by the IRED chip under normal operation.

Thermal impedance is defined as:

$$\theta_{JA} = (T_J - T_A) / P_D \quad (^\circ\text{C}/\text{W})$$

where:

- θ_{JA} = thermal impedance, junction to ambient
- T_J = junction temperature
- T_A = ambient temperature
- P_D = power dissipation of the device

By definition θ_{JA} assumes that the device is not connected to an external heat sink and as such represents a worse case condition in as far as power dissipation is concerned.

For plastic packages and non-heat-sunk hermetics:

$$\theta_{JA} \cong 400^\circ\text{C}/\text{W}$$

Example: A hermetic LED is driven with a forward current of 20 mA dc. At this drive current the forward voltage drop across the IRED is 1.5 volts.

$$P_D = (.020 \text{ A}) \times (1.5 \text{ V}) = .030 \text{ W}$$

$$\Delta T = (400^\circ\text{C}/\text{W}) \times (.030 \text{ W}) = 12^\circ\text{C}$$

$$(-0.9\%/^\circ\text{C}) \times 12^\circ\text{C} \cong -11\%$$

There is an 11% decrease in the amount of light generated by the IRED.

For hermetics with good heat sinking:

$$\theta_{JC} \cong 150^\circ\text{C}/\text{W}$$

where:

$$\theta_{JC} = \text{thermal impedance, junction to case}$$

$$\Delta T = (150^\circ\text{C}/\text{W}) \times (.030 \text{ W}) = 4.5^\circ\text{C}$$

$$(-0.9\%/^\circ\text{C}) \times (4.5^\circ\text{C}) \cong -4\%$$

There is only a 4% decrease in the amount of light generated by the IRED when a heat sink is used.

This is a clear example of the law of diminishing returns: increasing the forward drive current will increase the amount of light generated by the IRED. However, increasing the drive current also increases the power dissipation in the device. This raises the IRED's junction temperature resulting in a decrease in the IRED's efficiency.

One way to overcome this performance limiting characteristic is to pulse the IRED on and off rather than driving it with a dc current. Maximum light output is obtained because the average power dissipated is kept small. Above 100 mA of drive current it is advisable to limit the maximum pulse width to a few hundred microseconds, and a 10% duty cycle.

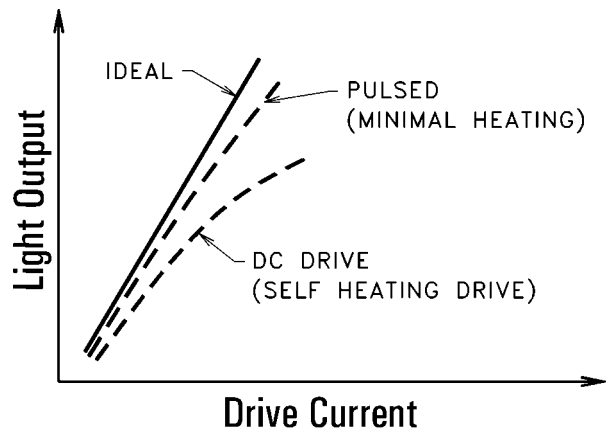

GaAlAs 880 nm IREDs - General Characteristics

FEATURES

- Nine standard packages in hermetic and low cost epoxy
- End and side radiating packages
- Graded output
- High efficiency GaAlAs 880 nm LPE process delivers twice the power of conventional GaAs 940 nm emitters

PRODUCT DESCRIPTION

This series of infrared emitting diodes (IREDs) consists of three standard chips in nine different packages, providing a broad range of mounting, lens, and power output options. Both end and side radiating cases, as well as narrow and wide angle emitters, are part of this series. All devices use high efficiency GaAlAs liquid phase epitaxial chips mounted P side down for highest output. TO-46 and some T-1 $\frac{3}{4}$ (5 mm) devices are double bonded for increased reliability in pulse applications.

These IREDs are ideally suited for use with PerkinElmer's silicon photodiodes or phototransistors.

Typical Characteristic Curves

Power Output vs. Time (@25°C)
Small IRED Chip

Coax, T-1 & Lateral Packages

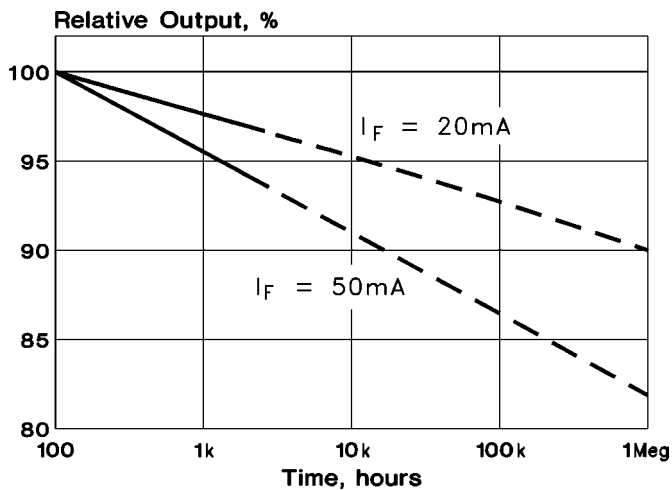

Power Output vs. Time (@25°C)
Large IRED Chip

TO-46 & T-1 $\frac{3}{4}$ Packages

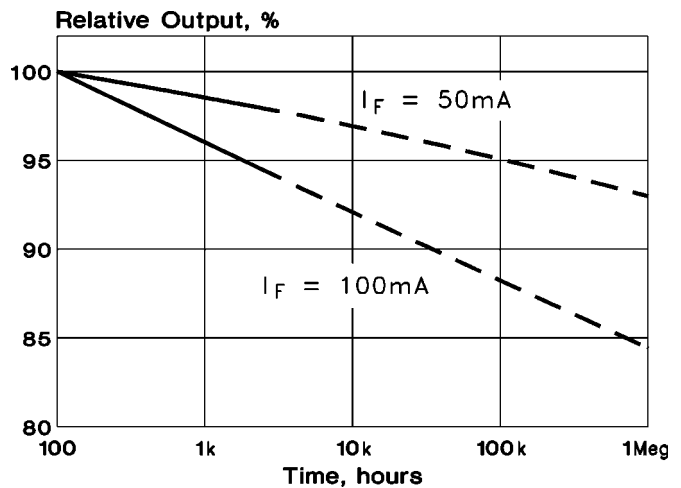

Power Output vs. Forward Current

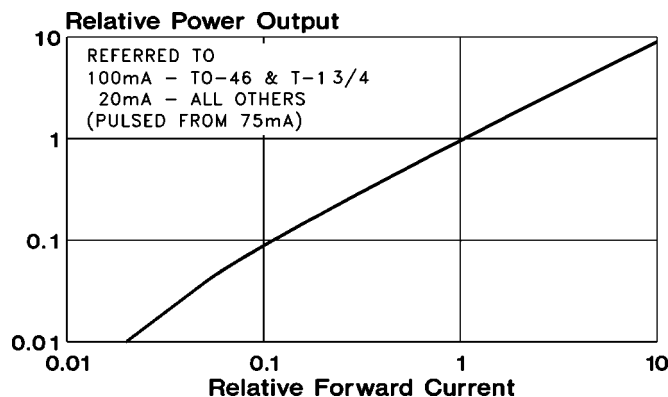

GaAlAs 880 nm IREDS - General Characteristics

Typical Characteristic Curves (cont.)

Angular Emission

T-1 Lateral Packages

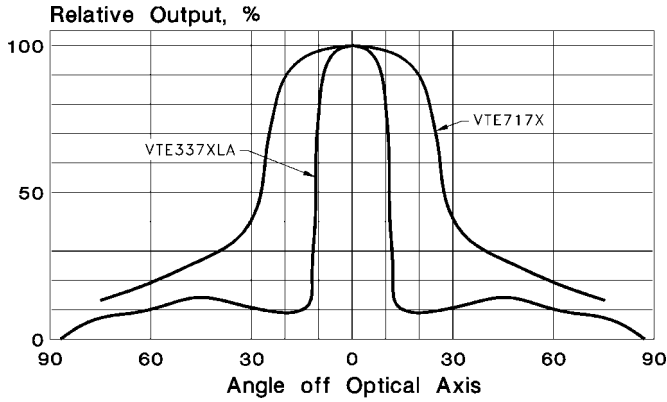

Angular Emission

T-1¾ Packages

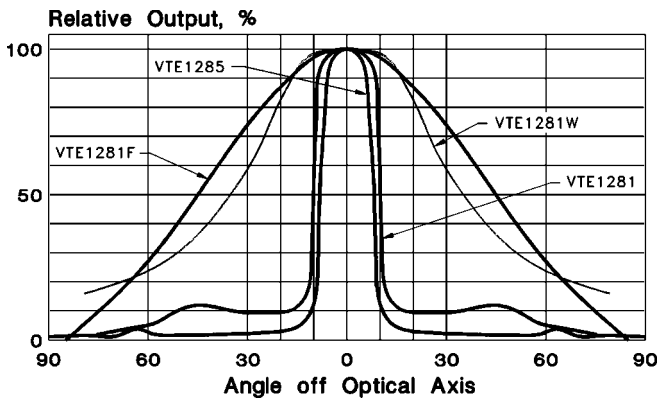

Angular Emission

TO-46 & Coax Packages

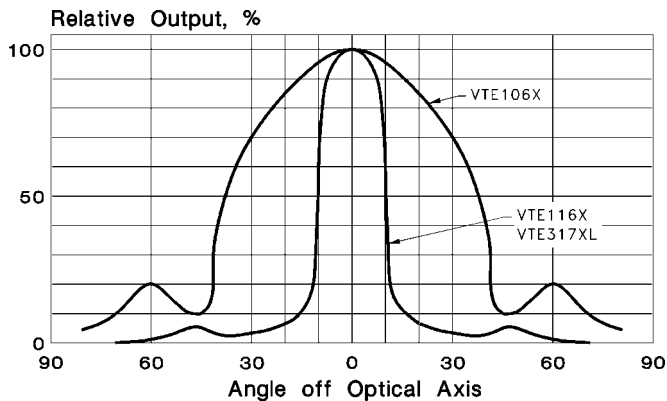

On Axis Relative Irradiance

T-1 & Lateral Packages

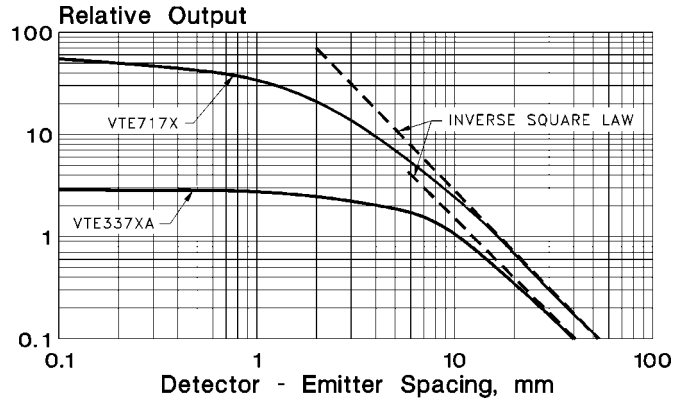

On Axis Relative Irradiance

TO-46 & T-1¾ Packages

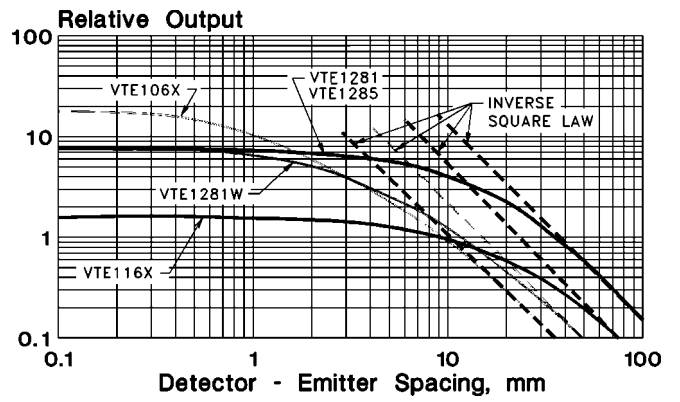

On Axis Relative Irradiance

Coax Packages

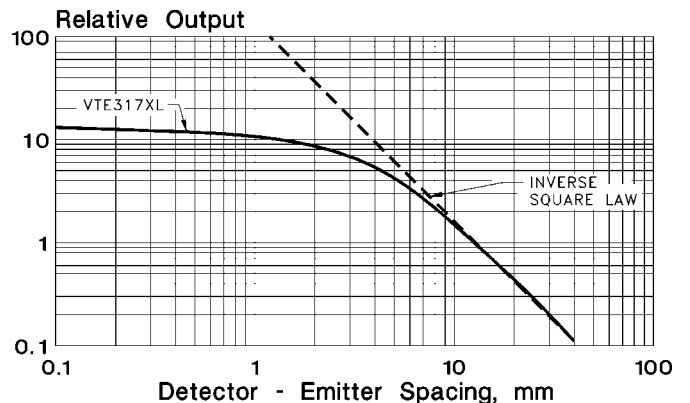

GaAlAs 880 nm IREDs - General Characteristics

Typical Characteristic Curves (cont.)

Forward Voltage vs. Forward Current

TO-46 & T-1¾ Packages

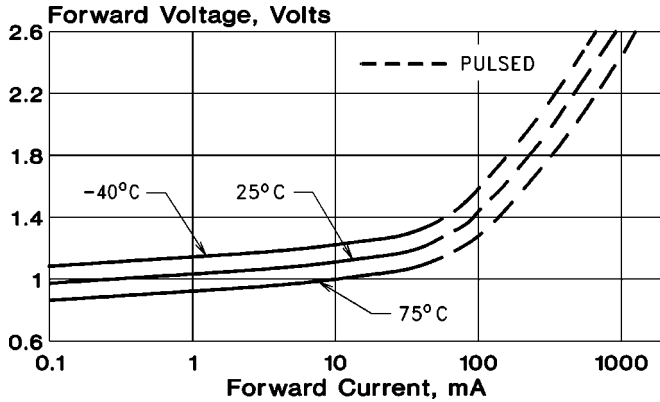

Forward Voltage vs. Forward Current

T-1, Lateral & Coax Packages

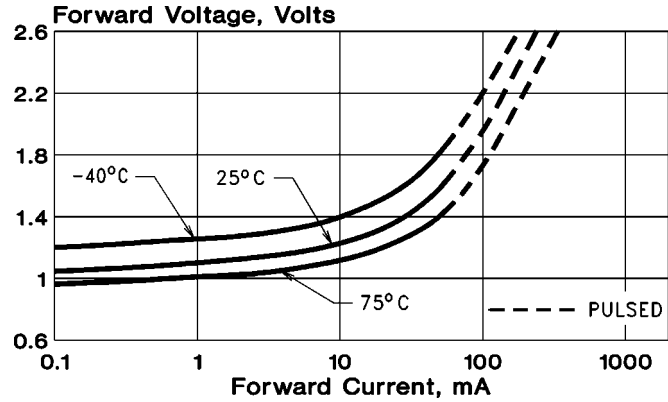

NOTES:

1. While the output of any series of IREDs is selected by the parameters shown as a minimum, devices may be selected by any of the three parameters shown on special order. For any series, there is a direct relationship between all three methods of specifying output; however, variations in lens and chip placements from unit to unit prevent perfect correlation between parameters. Thus, a unit which has high total power output may have a much lower than expected on axis radiant intensity and therefore produce a lower irradiance.

Total Power (P_O) is measured at the forward test current. All energy emitted in the forward direction is included.

Irradiance (E_e) is the average irradiance in milliwatts per square centimeter on a surface of diameter (D) at a distance (d). The irradiance will in general not be uniform over this whole surface, and may be more or less intense on the optical axis. When this is the characterizing parameter, irradiance at other distances may be determined from the graphs showing irradiance vs. separation.

Radiant Intensity (I_e) has the dimensions of milliwatts per steradian. To calculate the irradiance at any distance, the following formula is applicable: $E_e = I_e / d^2$ mW/cm²
For example, a device with a radiant intensity of 150 mW/sr would produce an irradiance of 0.6 μW/cm² at a 5 meter distance.

I_e is measured on axis at 36.3 mm from flange of the device. The detector is 6.35 mm dia. For near field irradiance where the inverse square law does not apply, see the graphs showing relative irradiance vs. separation.

2. I_{FT} is the steady state forward current unless otherwise specified. When pulse conditions are specified, the forward drop is the peak value.
3. $\theta_{1/2}$ is the angle between the optical axis and the half intensity point of the IRED's output beam pattern.
4. Pulse test current is 1.0 A peak. Pulse width is 100 μsec, pulse repetition rate is 10 pps.



PACKAGE DIMENSIONS inch (mm)

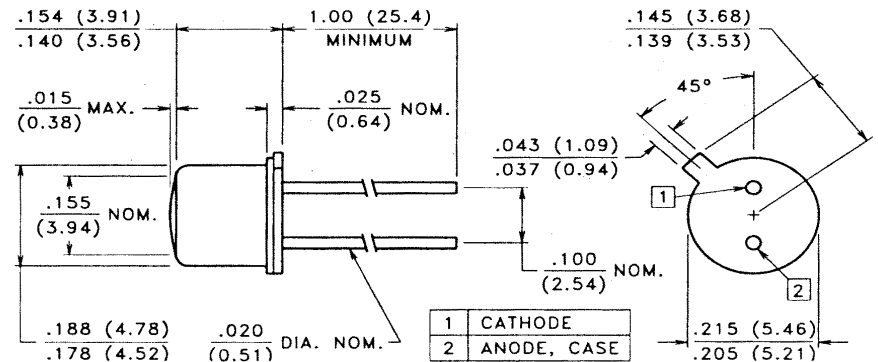

CASE 24 TO-46 HERMETIC (Flat Window)
CHIP SIZE: .018" x .018"

DESCRIPTION

This wide beam angle TO-46 hermetic emitter contains a large area, double wirebonded, GaAlAs, 880 nm, high efficiency IRED chip suitable for higher current pulse applications.

ABSOLUTE MAXIMUM RATINGS @ 25°C (unless otherwise noted) ■

Maximum Temperatures									
Storage and Operating:	-55°C to 125°C	Maximum Reverse Voltage:	5.0V						
Continuous Power Dissipation:	200 mW	Maximum Reverse Current @ $V_R = 5V$:	10 μA						
Derate above 30°C:	2.11 mW/°C	Peak Wavelength (Typical):	880 nm						
Maximum Continuous Current:	100 mA	Junction Capacitance @ 0V, 1 MHz (Typ.):	35 pF						
Derate above 30°C:	1.05 mA/°C	Response Time @ $I_F = 20$ mA							
Peak Forward Current, 10 μs , 100 pps:	3A	Rise: 1.0 μs Fall: 1.0 μs							
Temp. Coefficient of Power Output (Typ.):	-8%/°C	Lead Soldering Temperature:	260°C						
		(1.6 mm from case, 5 seconds max.)							

ELECTRO-OPTICAL CHARACTERISTICS @ 25°C (See also GaAlAs curves, pages 108-110)

Part Number ■	Output						Forward Drop		Half Power Beam Angle	
	Irradiance				Radiant Intensity	Total Power	Test Current	V_F		
	E_e		Condition		I_e	P_O	I_{FT}	@ I_{FT}	$\theta_{1/2}$	
	mW/cm ²		distance	Diameter	mW/sr	mW	mA (Pulsed)	Volts		Typ.
	Min.	Typ.	mm	mm	Min.	Typ.		Typ.	Max.	
VTE1063	3.8	5.0	36	6.4	49	80	1.0	2.8	3.5	$\pm 35^\circ$

■ Refer to General Product Notes, page 2.

GaAlAs Infrared Emitting Diodes

TO-46 Lensed Package — 880 nm

VTE1163



PACKAGE DIMENSIONS inch (mm)

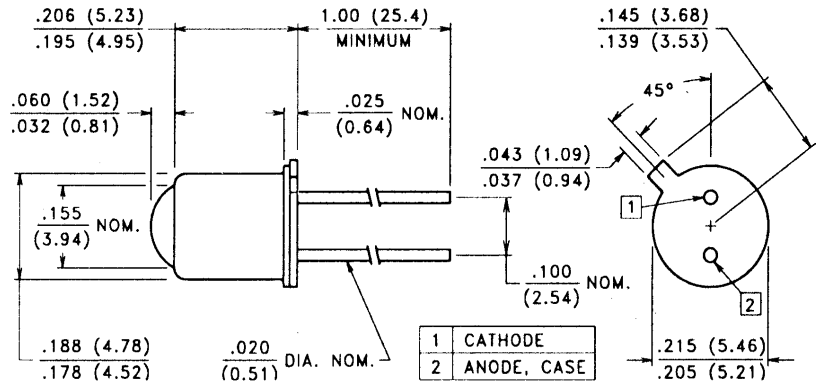

CASE 24 TO-46 HERMETIC (Lensed)
CHIP SIZE: .018" x .018"

DESCRIPTION

This narrow beam angle TO-46 hermetic emitter contains a large area, double wirebonded, GaAlAs, 880 nm, high efficiency IRED chip suitable for higher current pulse applications.

ABSOLUTE MAXIMUM RATINGS @ 25°C (unless otherwise noted) ■

Maximum Temperatures									
Storage and Operating:	-55°C to 125°C	Maximum Reverse Voltage:	5.0V						
Continuous Power Dissipation:	200 mW	Maximum Reverse Current @ $V_R = 5V$:	10 μA						
Derate above 30°C:	2.11 mW/°C	Peak Wavelength (Typical):	880 nm						
Maximum Continuous Current:	100 mA	Junction Capacitance @ 0V, 1 MHz (Typ.):	35 pF						
Derate above 30°C:	1.05 mA/°C	Response Time @ $I_F = 20 mA$							
Peak Forward Current, 10 μs , 100 pps:	3A	Rise: 1.0 μs Fall: 1.0 μs							
Temp. Coefficient of Power Output (Typ.):	-8%/°C	Lead Soldering Temperature:	260°C						
		(1.6 mm from case, 5 seconds max.)							

ELECTRO-OPTICAL CHARACTERISTICS @ 25°C (See also GaAlAs curves, pages 108-110)

Part Number ■	Output						Forward Drop		Half Power Beam Angle	
	Irradiance		Radiant Intensity	Total Power	Test Current	V_F				
	E_e	Condition		I_e	P_O	I_{FT}	@ I_{FT}	$\theta_{1/2}$		
	mW/cm ²	distance	Diameter	mW/sr	mW	mA	Volts			
	Min.	Typ.	mm	mm	Min.	Typ.	Typ.	Max.	Typ.	
VTE1163	22	28	36	6.4	285	110	1.0	2.8	3.5	$\pm 10^\circ$

■ Refer to General Product Notes, page 2.



PACKAGE DIMENSIONS inch (mm)

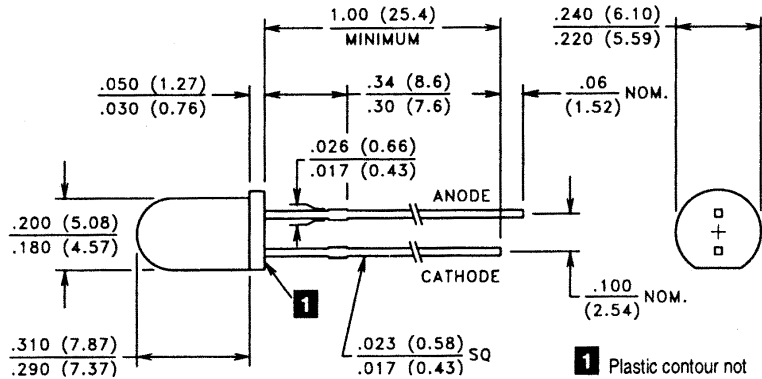

1 Plastic contour not controlled in region of the leads.

CASE 26 T-1 $\frac{3}{4}$ (5 mm)
CHIP SIZE: .018" x .018"

DESCRIPTION

This narrow beam angle 5 mm diameter plastic packaged emitter contains a large area, double wirebonded, GaAlAs, 880 nm, high efficiency IRED chip suitable for higher current pulse applications.

ABSOLUTE MAXIMUM RATINGS @ 25°C (unless otherwise noted) ■

Maximum Temperatures		Maximum Reverse Voltage:	5.0V
Storage and Operating:	-40°C to 100°C	Maximum Reverse Current @ $V_R = 5V$:	10 μA
Continuous Power Dissipation:	200 mW	Peak Wavelength (Typical):	880 nm
Derate above 30°C:	2.86 mW/°C	Junction Capacitance @ 0V, 1 MHz (Typ.):	35 pF
Maximum Continuous Current:	100 mA	Response Time @ $I_F = 20 mA$	
Derate above 30°C:	1.43 mA/°C	Rise: 1.0 μs Fall: 1.0 μs	
Peak Forward Current, 10 μs , 100 pps:	3.0 A	Lead Soldering Temperature:	260°C
Temp. Coefficient of Power Output (Typ.):	-8%/°C	(1.6 mm from case, 5 seconds max.)	

ELECTRO-OPTICAL CHARACTERISTICS @ 25°C (See also GaAlAs curves, pages 108-110)

Part Number	Output						Forward Drop		Half Power Beam Angle	
	Irradiance				Radiant Intensity	Total Power	Test Current	V_F		
	E_e		Condition		I_e	P_O	I_{FT}	@ I_{FT}	$\theta_{1/2}$	
	mW/cm ²		distance	Diameter	mW/sr	mW	mA (Pulsed)	Volts		Typ.
	Min.	Typ.	mm	mm	Min.	Typ.		Typ.	Max.	
VTE1261	3.0	3.9	36	6.4	39	20	100	1.5	2.0	$\pm 10^\circ$
VTE1262	4.0	5.2	36	6.4	52	25	100	1.5	2.0	$\pm 10^\circ$

■ Refer to General Product Notes, page 2.

GaAlAs Infrared Emitting Diodes

T-1 $\frac{3}{4}$ (5 mm) Plastic Package — 880 nm

VTE1281-1, -2



PACKAGE DIMENSIONS inch (mm)

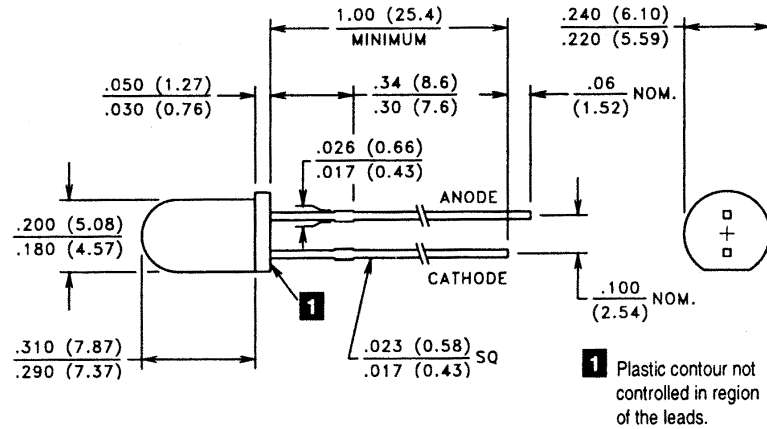

CASE 26 T-1 $\frac{3}{4}$ (5 mm)
CHIP SIZE: .015" x .015"

DESCRIPTION

This narrow beam angle 5 mm diameter plastic packaged emitter contains a medium area, single wirebonded, GaAlAs, 880 nm, high efficiency IRED chip. It is designed to be cost effective in moderate pulse drive applications.

ABSOLUTE MAXIMUM RATINGS @ 25°C (unless otherwise noted) ■

Maximum Temperatures		Maximum Reverse Voltage:	5.0V
Storage and Operating:	-40°C to 100°C	Maximum Reverse Current @ $V_R = 5V$:	10 μA
Continuous Power Dissipation:	200 mW	Peak Wavelength (Typical):	880 nm
Derate above 30°C:	2.86 mW/°C	Junction Capacitance @ 0V, 1 MHz (Typ.):	23 pF
Maximum Continuous Current:	100 mA	Response Time @ $I_F = 20$ mA	
Derate above 30°C:	1.43 mA/°C	Rise: 1.0 μs Fall: 1.0 μs	
Peak Forward Current, 10 μs , 100 pps:	2.5 A	Lead Soldering Temperature:	260°C
Temp. Coefficient of Power Output (Typ.):	-8%/°C	(1.6 mm from case, 5 seconds max.)	

ELECTRO-OPTICAL CHARACTERISTICS @ 25°C (See also GaAlAs curves, pages 108-110)

Part Number	Output						Forward Drop		Half Power Beam Angle	
	Irradiance		Radiant Intensity	Total Power	Test Current	V_F				
	E_e	Condition		I_e	P_O	I_{FT}	@ I_{FT}			
	mW/cm ²	distance	Diameter	mW/sr	mW	mA (Pulsed)	Volts			
	Min.	Typ.	mm	mm	Min.	Typ.	Typ.	Max.		
VTE1281-1	2.5	3.3	36	6.4	32	20	100	1.5	2.0	$\pm 10^\circ$
VTE1281-2	5.0	6.5	36	6.4	65	25	100	1.5	2.0	$\pm 10^\circ$

■ Refer to General Product Notes, page 2.

GaAlAs Infrared Emitting Diodes

Flat T-1 $\frac{3}{4}$ (5 mm) Plastic Package — 880 nm

VTE1281F

SUNSTAR 传感器与检测 http://www.sensor-ic.com/ TEL: 0755-83376489 FAX: 0755-83376182 E-MAIL: szss20@163.com

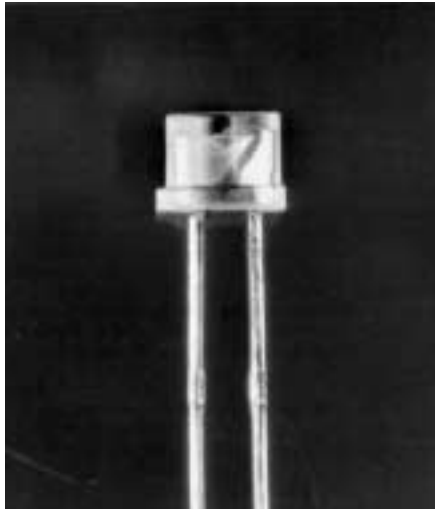

PACKAGE DIMENSIONS inch (mm)

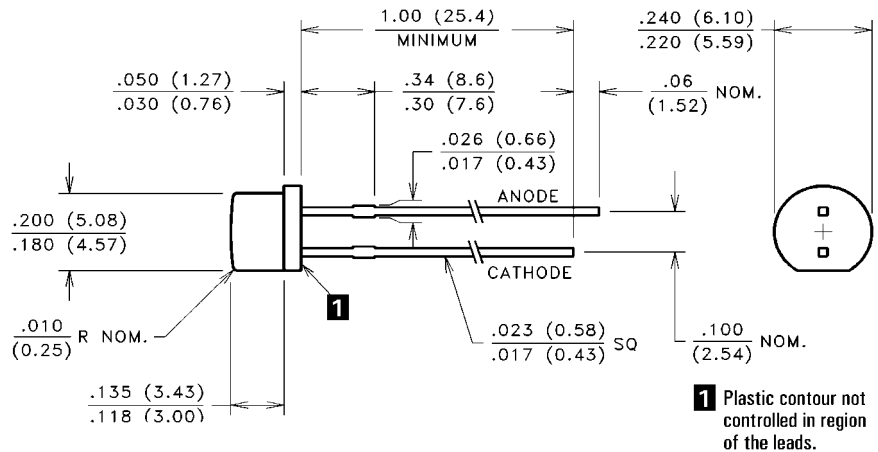

DESCRIPTION

CASE 26F T-1 $\frac{3}{4}$ (5 mm) FLAT
CHIP SIZE: .015" x .015"

This 5 mm diameter plastic packaged emitter has no lens. It is designed to be coupled to plastic fibers or used to illuminate an external lens. It contains a medium area, single wirebonded, GaAlAs 880 nm chip and is designed to be cost effective in moderate pulse drive applications.

ABSOLUTE MAXIMUM RATINGS @ 25°C (unless otherwise noted) ■

Maximum Temperatures									
Storage and Operating:	-40°C to 100°C	Maximum Reverse Voltage:	5.0V						
Continuous Power Dissipation:	150 mW	Maximum Reverse Current @ $V_R = 5V$:	10 μA						
Derate above 30°C:	2.14 mW/°C	Peak Wavelength (Typical):	880 nm						
Maximum Continuous Current:	100 mA	Junction Capacitance @ 0V, 1 MHz (Typ.):	23 pF						
Derate above 30°C:	1.43 mA/°C	Response Time @ $I_F = 20$ mA							
Peak Forward Current, 10 μs , 100 pps:	2.5 A	Rise: 1.0 μs Fall: 1.0 μs							
Temp. Coefficient of Power Output (Typ.):	-8%/°C	Lead Soldering Temperature:	260°C						
		(1.6 mm from case, 5 seconds max.)							

ELECTRO-OPTICAL CHARACTERISTICS @ 25°C (See also GaAlAs curves, pages 108-110)

Part Number ■	Output						Forward Drop		Half Power Beam Angle	
	Irradiance		Radiant Intensity	Total Power	Test Current	V_F				
	E_e		Condition	I_e	P_O	I_{FT}	@ I_{FT}		$\theta_{1/2}$	
	mW/cm ²						Volts			
	Min.	Typ.	mm	mm	Min.	Typ.	Max.	Typ.		
VTE1281F	0.16	0.21	36	6.4	2.1	20	100	1.5	2.0	$\pm 45^\circ$

■ Refer to General Product Notes, page 2.

GaAlAs Infrared Emitting Diodes

T-1 $\frac{3}{4}$ (5 mm) Plastic Package — 880 nm

VTE1281W-1, W-2

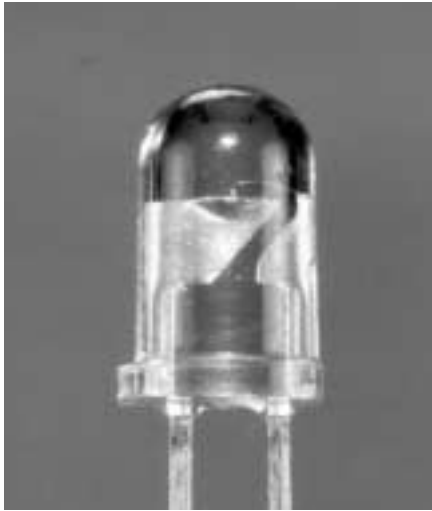

PACKAGE DIMENSIONS inch (mm)

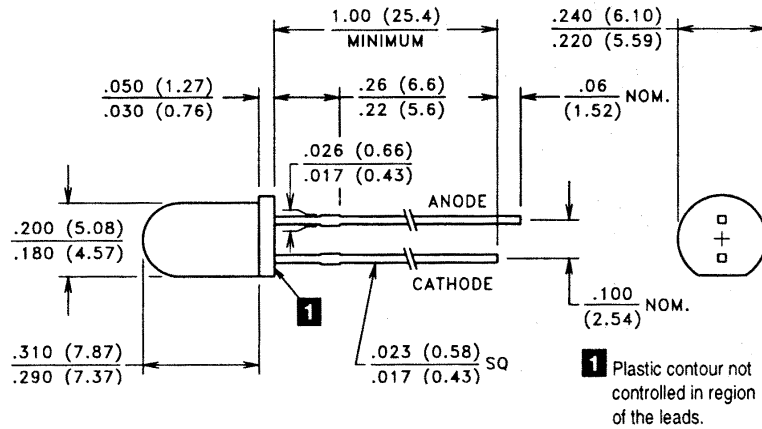

CASE 26W T-1 $\frac{3}{4}$ (5 mm) WIDE ANGLE
CHIP SIZE: .015" x .015"

DESCRIPTION

This wide beam angle 5 mm diameter plastic packaged emitter contains a GaAlAs, 880 nm IRED chip. It is a cost effective design and is well suited for high current pulse applications.

ABSOLUTE MAXIMUM RATINGS @ 25°C (unless otherwise noted) ■

Maximum Temperatures		Maximum Reverse Voltage:	5.0V
Storage and Operating:	-40°C to 100°C	Maximum Reverse Current @ $V_R = 5V$:	10 μA
Continuous Power Dissipation:	200 mW	Peak Wavelength (Typical):	880 nm
Derate above 30°C:	2.86 mW/°C	Junction Capacitance @ 0V, 1 MHz (Typ.):	23 pF
Maximum Continuous Current:	100 mA	Response Time @ $I_F = 20 mA$	
Derate above 30°C:	1.43 mA/°C	Rise: 1.0 μs Fall: 1.0 μs	
Peak Forward Current, 10 μs , 100 pps:	2.5 A	Lead Soldering Temperature:	260°C
Temp. Coefficient of Power Output (Typ.):	-8%/°C	(1.6 mm from case, 5 seconds max.)	

ELECTRO-OPTICAL CHARACTERISTICS @ 25°C (See also GaAlAs curves, pages 108-110)

Part Number ■	Output						Forward Drop		Half Power Beam Angle	
	Irradiance		Radiant Intensity	Total Power	Test Current	V_F				
	E_e	Condition		I_e	P_O	I_{FT}	@ I_{FT}	$\theta_{1/2}$		
	mW/cm ²	distance	Diameter	mW/sr	mW	mA	Volts		Typ.	
	Min.	Typ.	mm	mm	Min.	Typ.	Typ.	Max.		
VTE1281W-1	1.2	1.6	36	6.4	16	20	100	1.5	2.0	$\pm 25^\circ$
VTE1281W-2	2.5	3.3	36	6.4	32	25	100	1.5	2.0	$\pm 25^\circ$

■ Refer to General Product Notes, page 2.



PACKAGE DIMENSIONS inch (mm)

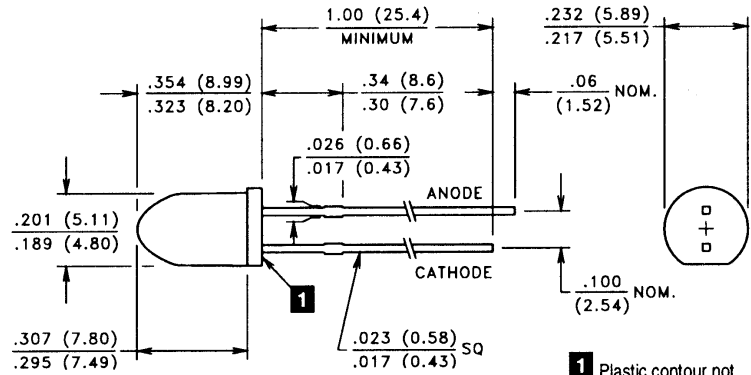

1 Plastic contour not controlled in region of the leads.

CASE 62 T-1³/₄ (5 mm) BULLET
CHIP SIZE: .015" x .015"

DESCRIPTION

This 5 mm diameter, custom lensed device contains a medium area, single wirebonded, GaAlAs, 880 nm high efficiency IRED chip. The custom lens allows this cost effective device to have a very narrow half power beam emission of ±8°.

ABSOLUTE MAXIMUM RATINGS @ 25°C (unless otherwise noted) ■

Maximum Temperatures		Maximum Reverse Voltage:	5.0V
Storage and Operating:	-40°C to 100°C	Maximum Reverse Current @ V _R = 5V:	10 μA
Continuous Power Dissipation:	200 mW	Peak Wavelength (Typical):	880 nm
Derate above 30°C:	2.86 mW/°C	Junction Capacitance @ 0V, 1 MHz (Typ.):	23 pF
Maximum Continuous Current:	100 mA	Response Time @ I _F = 20 mA	
Derate above 30°C:	1.43 mA/°C	Rise: 1.0 μs Fall: 1.0 μs	
Peak Forward Current, 10 μs, 100 pps:	2.5 A	Lead Soldering Temperature:	260°C
Temp. Coefficient of Power Output (Typ.):	-8%/°C	(1.6 mm from case, 5 seconds max.)	

ELECTRO-OPTICAL CHARACTERISTICS @ 25°C (See also GaAlAs curves, pages 108-110)

Part Number ■	Output						Forward Drop		Half Power Beam Angle	
	Irradiance		Radiant Intensity	Total Power	Test Current	V _F				
	E _e		Condition		I _e	P _O	I _{FT}	@ I _{FT}	θ _{1/2}	
	mW/cm ²		distance	Diameter	mW/sr	mW	mA (Pulsed)	Volts		Typ.
	Min.	Typ.	mm	mm	Min.	Typ.		Typ.	Max.	
VTE1285	3.0	5.5	36	6.4	39	20	100	1.5	2.0	±8°

■ Refer to General Product Notes, page 2.

GaAlAs Infrared Emitting Diodes

T-1 $\frac{3}{4}$ (5 mm) Plastic Package — 880 nm

VTE1291-1, 1291-2



PACKAGE DIMENSIONS inch (mm)

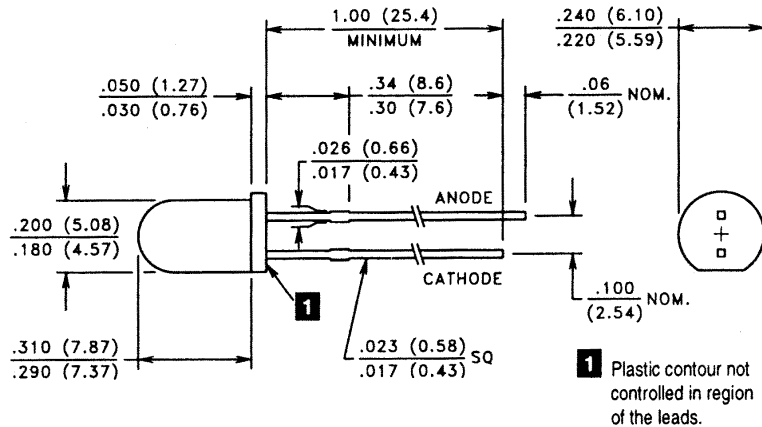

CASE 26 T-1 $\frac{3}{4}$ (5 mm)
CHIP SIZE: .015" x .015"

DESCRIPTION

This narrow beam angle 5 mm plastic packaged emitter contains a double wirebonded, GaAlAs, 880 nm IRED chip. This cost effective design is well suited for dc or high current pulse applications. This device is a UL recognized component for smoke alarm applications (UL file #S3506).

ABSOLUTE MAXIMUM RATINGS @ 25°C (unless otherwise noted) ■

Maximum Temperatures		Maximum Reverse Voltage:	5.0V
Storage and Operating:	-40°C to 100°C	Maximum Reverse Current @ $V_R = 5V$:	10 μA
Continuous Power Dissipation:	200 mW	Peak Wavelength (Typical):	880 nm
Derate above 30°C:	2.86 mW/°C	Junction Capacitance @ 0V, 1 MHz (Typ.):	23 pF
Maximum Continuous Current:	100 mA	Response Time @ $I_F = 20 mA$	
Derate above 30°C:	1.43 mA/°C	Rise: 1.0 μs Fall: 1.0 μs	
Peak Forward Current, 10 μs , 100 pps:	2.5 A	Lead Soldering Temperature:	260°C
Temp. Coefficient of Power Output (Typ.):	-8%/°C	(1.6 mm from case, 5 seconds max.)	

ELECTRO-OPTICAL CHARACTERISTICS @ 25°C (See also GaAlAs curves, pages 108-110)

Part Number	Output						Forward Drop		Half Power Beam Angle	
	Irradiance				Radiant Intensity	Total Power	Test Current	V_F		
	E_e		Condition		I_e	P_O	I_{FT}	@ I_{FT}	$\theta_{1/2}$	
	mW/cm ²		distance	Diameter	mW/sr	mW	mA	Volts		
	Min.	Typ.	mm	mm	Min.	Typ.	(Pulsed)	Typ.	Max.	
VTE1291-1	2.5	3.3	36	6.4	32	20	100	1.5	2.0	$\pm 12^\circ$
VTE1291-2	5.0	6.5	36	6.4	65	25	100	1.5	2.0	$\pm 12^\circ$

■ Refer to General Product Notes, page 2.

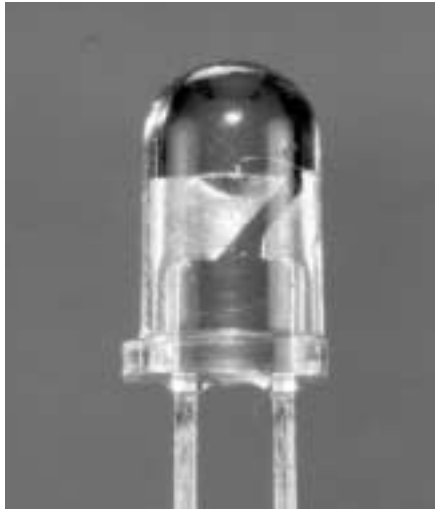

PACKAGE DIMENSIONS inch (mm)

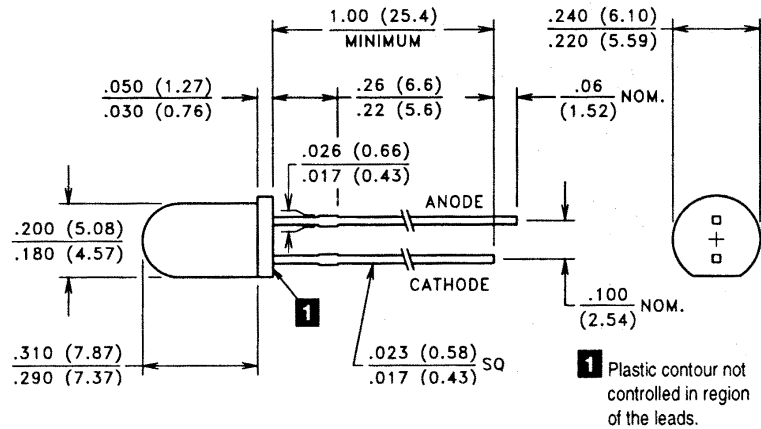

CASE 26W T-1³/₄ (5 mm) WIDE ANGLE
CHIP SIZE: .015" x .015"

DESCRIPTION

This wide beam angle 5 mm plastic packaged emitter contains a double wirebonded, GaAlAs, 880 nm IRED chip. This cost effective design is well suited for dc or high current pulse applications. This device is a UL recognized component for smoke alarm applications (UL file #S3506).

ABSOLUTE MAXIMUM RATINGS @ 25°C (unless otherwise noted) ■

Maximum Temperatures		Maximum Reverse Voltage:	5.0V
Storage and Operating:	-40°C to 100°C	Maximum Reverse Current @ V _R = 5V:	10 μA
Continuous Power Dissipation:	200 mW	Peak Wavelength (Typical):	880 nm
Derate above 30°C:	2.86 mW/°C	Junction Capacitance @ 0V, 1 MHz (Typ.):	23 pF
Maximum Continuous Current:	100 mA	Response Time @ I _F = 20 mA	
Derate above 30°C:	1.43 mA/°C	Rise: 1.0 μs Fall: 1.0 μs	
Peak Forward Current, 10 μs, 100 pps:	2.5 A	Lead Soldering Temperature:	260°C
Temp. Coefficient of Power Output (Typ.):	-8%/°C	(1.6 mm from case, 5 seconds max.)	

ELECTRO-OPTICAL CHARACTERISTICS @ 25°C (See also GaAlAs curves, pages 108-110)

Part Number ■	Output						Forward Drop		Half Power Beam Angle	
	Irradiance		Radiant Intensity	Total Power	Test Current	V _F				
	E _e		Condition	I _e	P _O	I _{FT}	@ I _{FT}			
	mW/cm ²						Volts			
	Min.	Typ.	distance	Diameter	Min.	Typ.	Typ.	Max.		
VTE1291W-1	1.2	1.6	36	6.4	16	20	100	1.5	2.0	±25°
VTE1291W-2	2.5	3.3	36	6.4	32	25	100	1.5	2.0	±25°

■ Refer to General Product Notes, page 2.

GaAlAs Infrared Emitting Diodes

T-1 $\frac{3}{4}$ (5 mm) Bullet Package — 880 nm

VTE1295

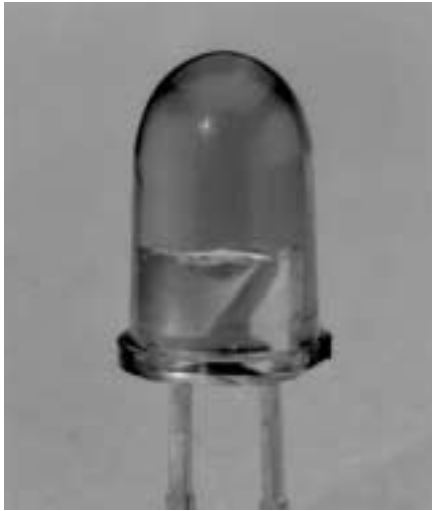

PACKAGE DIMENSIONS inch (mm)

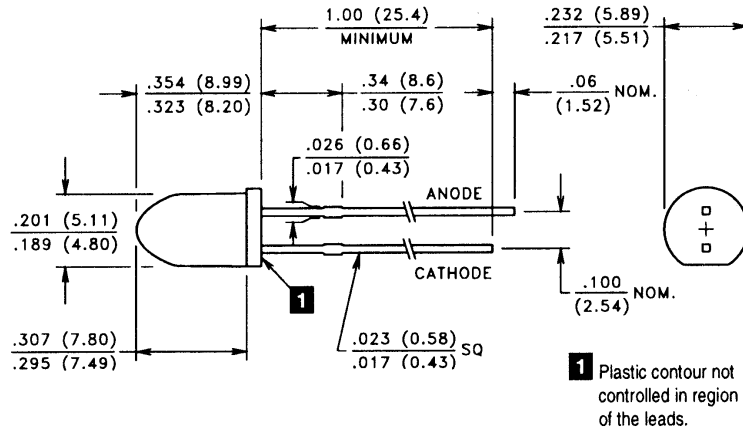

CASE 62 T-1 $\frac{3}{4}$ (5 mm) BULLET
CHIP SIZE: .015" x .015"

DESCRIPTION

This 5 mm diameter, custom lensed device contains a medium area, single wirebonded, GaAlAs, 880 nm high efficiency IRED chip. The custom lens allows this cost effective device to have a very narrow half power beam emission of $\pm 8^\circ$. This device is a UL recognized component for smoke alarm applications (UL file #S3506).

ABSOLUTE MAXIMUM RATINGS @ 25°C (unless otherwise noted) ■

Maximum Temperatures		Maximum Reverse Voltage:	5.0V
Storage and Operating:	-40°C to 100°C	Maximum Reverse Current @ $V_R = 5V$:	10 μA
Continuous Power Dissipation:	200 mW	Peak Wavelength (Typical):	880 nm
Derate above 30°C:	2.86 mW/°C	Junction Capacitance @ 0V, 1 MHz (Typ.):	23 pF
Maximum Continuous Current:	100 mA	Response Time @ $I_F = 20$ mA	
Derate above 30°C:	1.43 mA/°C	Rise: 1.0 μs Fall: 1.0 μs	
Peak Forward Current, 10 μs , 100 pps:	2.5 A	Lead Soldering Temperature:	260°C
Temp. Coefficient of Power Output (Typ.):	-8%/°C	(1.6 mm from case, 5 seconds max.)	

ELECTRO-OPTICAL CHARACTERISTICS @ 25°C (See also GaAlAs curves, pages 108-110)

Part Number ■	Output						Forward Drop		Half Power Beam Angle	
	Irradiance		Radiant Intensity	Total Power	Test Current	V_F				
	E_e	Condition		I_e	P_O	I_{FT}	@ I_{FT}	$\theta_{1/2}$		
	mW/cm ²	distance	Diameter	mW/sr	mW	mA	Volts			
	Min.	Typ.	mm	mm	Min.	Typ.	Typ.	Max.	Typ.	
VTE1295	3.0	5.5	36	6.4	39	20	100	1.5	2.0	$\pm 8^\circ$

■ Refer to General Product Notes, page 2.

GaAlAs Infrared Emitting Diodes

Long T-1 (3 mm) Plastic Package — 880 nm

VTE3372LA, 74LA



PACKAGE DIMENSIONS inch (mm)

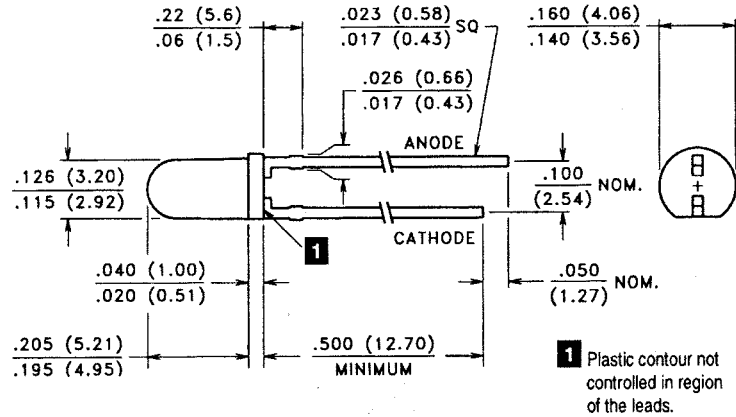

CASE 50A Long T-1 (3 mm)
CHIP SIZE: .011" x .011"

DESCRIPTION

This narrow beam angle 3 mm diameter plastic packaged emitter is suitable for use in optical switch applications. It contains a small area, GaAlAs, 880 nm, high efficiency IRED die.

ABSOLUTE MAXIMUM RATINGS @ 25°C (unless otherwise noted) ■

Maximum Temperatures			
Storage and Operating:	-40°C to 100°C	Maximum Reverse Voltage:	5.0V
Continuous Power Dissipation:	100 mW	Maximum Reverse Current @ $V_R = 5V$:	10 μA
Derate above 30°C:	1.43 mW/°C	Peak Wavelength (Typical):	880 nm
Maximum Continuous Current:	50 mA	Junction Capacitance @ 0V, 1 MHz (Typ.):	14 pF
Derate above 30°C:	0.71 mA/°C	Response Time @ $I_F = 20$ mA	
Peak Forward Current, 10 μs , 100 pps:	2.5 A	Rise: 1.0 μs Fall: 1.0 μs	
Temp. Coefficient of Power Output (Typ.):	-8%/°C	Lead Soldering Temperature:	260°C
		(1.6 mm from case, 5 seconds max.)	

ELECTRO-OPTICAL CHARACTERISTICS @ 25°C (See also GaAlAs curves, pages 108-110)

Part Number ■	Output						Forward Drop		Half Power Beam Angle	
	Irradiance				Radiant Intensity	Total Power	Test Current	V_F		
	E_e		Condition		I_e	P_O	I_{FT}	@ I_{FT}	$\theta_{1/2}$	
	mW/cm ²		distance	Diameter	mW/sr	mW	mA (Pulsed)	Volts		Typ.
	Min.	Typ.	mm	mm	Min.	Typ.		Typ.	Max.	
VTE3372LA	2.0	2.6	10.16	2.1	2.0	3.0	20	1.3	1.8	$\pm 10^\circ$
VTE3374LA	4.0	5.2	10.16	2.1	4.1	5.0	20	1.3	1.8	$\pm 10^\circ$

■ Refer to General Product Notes, page 2.

GaAlAs Infrared Emitting Diodes

Molded Lateral Package — 880 nm

VTE7172, 7173

SUNSTAR 传感器控制 (深圳) 有限公司 // www.sensor-ic.com/ TEL: 0755-83376549 FAX: 0755-83376182 E-MAIL: szss20@163.com

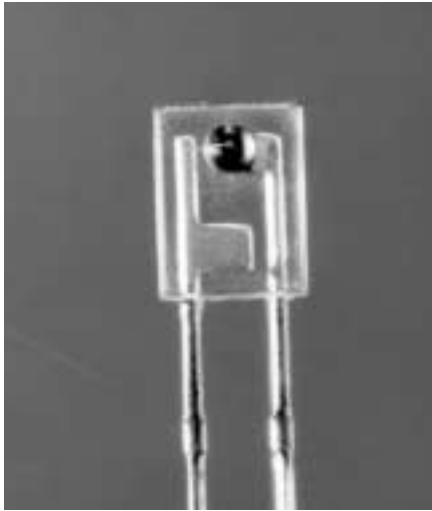

PACKAGE DIMENSIONS inch (mm)

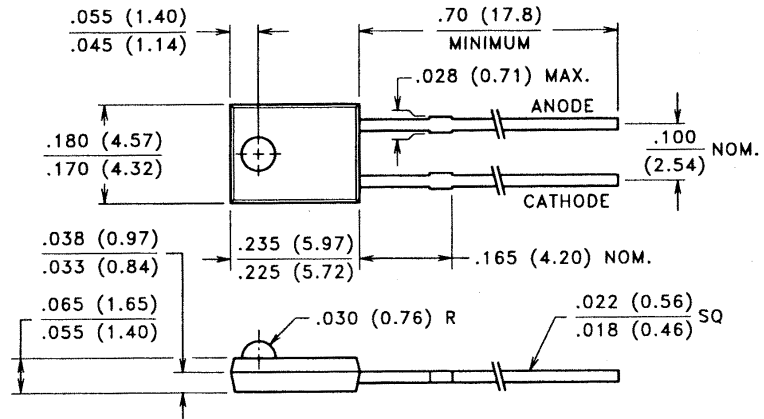

CASE 7 LATERAL
CHIP SIZE: .011" x .011"

DESCRIPTION

These side-looking packages are designed for use in PC board mounted interrupt detectors. The package is transfer molded plastic and contains a high efficiency, 880 nm, GaAlAs IRED die.

ABSOLUTE MAXIMUM RATINGS @ 25°C (unless otherwise noted) ■

Maximum Temperatures			
Storage and Operating:	-40°C to 85°C	Maximum Reverse Voltage:	5.0V
Continuous Power Dissipation:	100 mW	Maximum Reverse Current @ $V_R = 5V$:	10 μA
Derate above 30°C:	1.82 mW/°C	Peak Wavelength (Typical):	880 nm
Maximum Continuous Current:	50 mA	Junction Capacitance @ 0V, 1 MHz (Typ.):	14 pF
Derate above 30°C:	0.91 mA/°C	Response Time @ $I_F = 20$ mA	
Peak Forward Current, 10 μs , 100 pps:	2.5 A	Rise: 1.0 μs Fall: 1.0 μs	
Temp. Coefficient of Power Output (Typ.):	-8%/°C	Lead Soldering Temperature:	260°C
		(1.6 mm from case, 5 seconds max.)	

ELECTRO-OPTICAL CHARACTERISTICS @ 25°C (See also GaAlAs curves, pages 108-110)

Part Number ■	Output						Forward Drop		Half Power Beam Angle	
	Irradiance		Radiant Intensity	Total Power	Test Current	V_F				
	E_e	Condition	I_e	P_O	I_{FT}	@ I_{FT}				
	mW/cm ²	distance	Diameter	mW/sr	mW	Volts				
	Min.	Typ.	mm	mm	Min.	Typ.	Max.			
VTE7172	0.4	0.6	16.7	4.6	1.1	2.5	20	1.3	1.8	$\pm 25^\circ$
VTE7173	0.6	0.8	16.7	4.6	1.7	5.0	20	1.3	1.8	$\pm 25^\circ$

■ Refer to General Product Notes, page 2.

GaAs 940 nm Infrared Light Emitting Diodes

Features

- Three standard packages in hermetic and low cost epoxy
- End radiating packages
- High power GaAs, 940 nm LPE process

Product Description

This series of infrared emitting diodes (IREDs) consists of two standard chips in three different packages. All devices use high efficiency GaAs liquid phase epitaxial chips mounted P side down for highest output. TO-46 devices are double bonded for increased reliability in pulse applications.

These IREDs are ideally suited for use with PerkinElmer's silicon photodiodes or phototransistors.

Typical Characteristic Curves

Power Output vs. Time (@25°C)
Small IRED Chip

Long T-1 Package

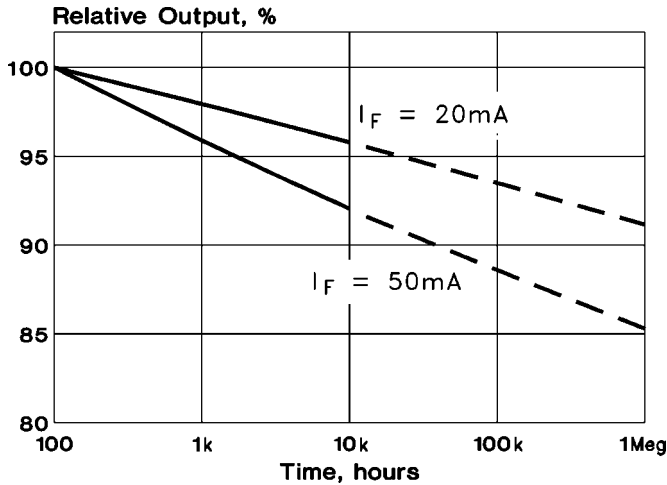

Power Output vs. Time (@25°C)
Large IRED Chip

TO-46 Packages

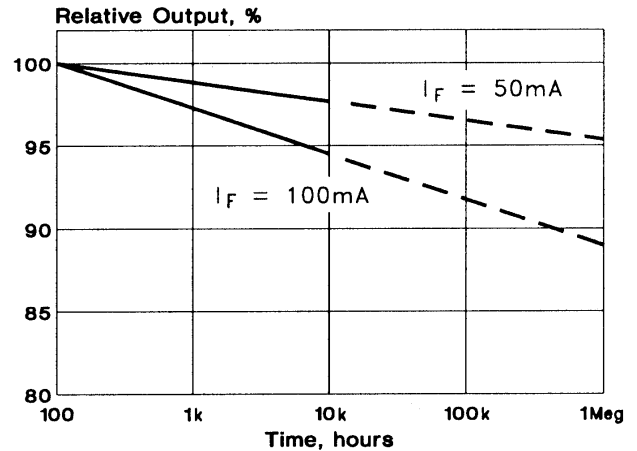

On Axis Relative Irradiance

TO-46 Packages

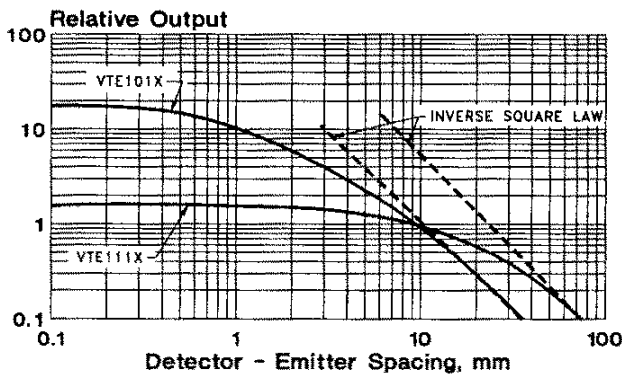

Power Output vs. Forward Current

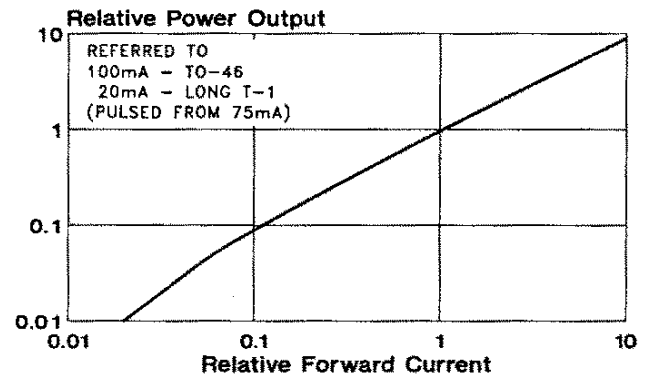

GaAs 940 nm Infrared Light Emitting Diodes

Typical Characteristic Curves (cont.)

Angular Response

TO-46 Package

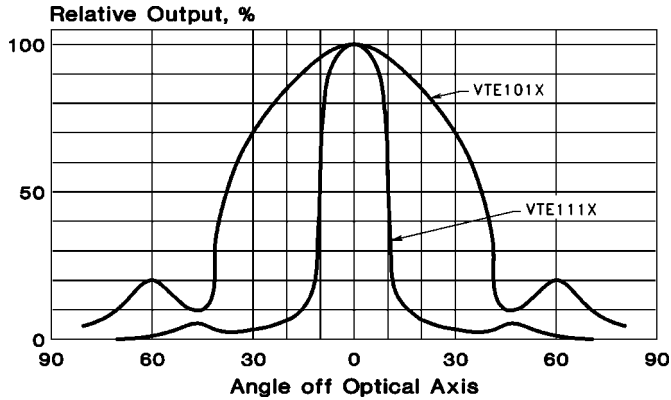

Angular Response

Long T-1 Package

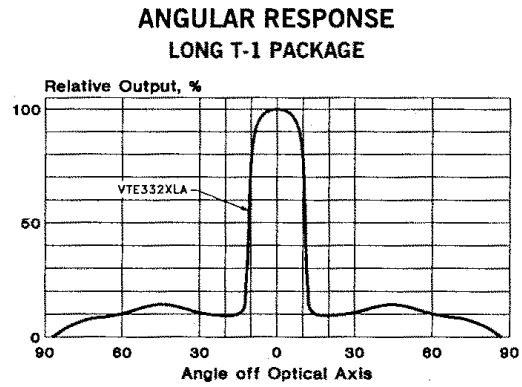

Forward Voltage vs. Forward Current

TO-46 Packages

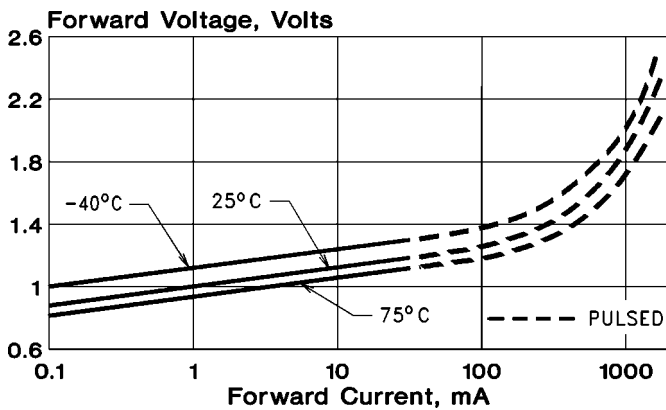

Forward Voltage vs. Forward Current

Long T-1 Package

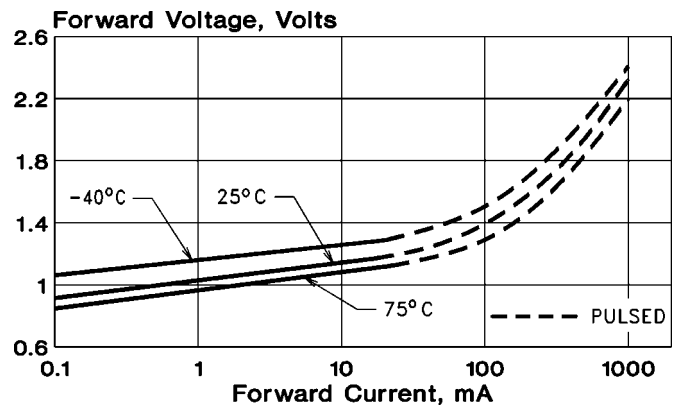

Notes:

1. While the output of any series of IREDs is selected by the parameters shown as minimum, devices may be selected by any of the three parameters shown on special order. For any series, there is a direct relationship between all three methods of specifying output; however, variations in lens and chip placements from unit to unit prevent perfect correlation between parameters. Thus, a unit which has high total power output may have a much lower than expected on axis radiant intensity and therefore produce a lower irradiance.

Total Power (P_0) is measured at the forward test current. All energy emitted in the forward direction is included.

Irradiance (E_e) is the average irradiance in milliwatts per square centimeter on a surface of diameter (D) at a distance (d). The irradiance will in general not be uniform over this whole surface, and may be more or less on the optical axis. When this is the characterizing parameter, irradiance at other distances may be determined from the graphs showing irradiance vs. separation.

GaAs 940 nm Infrared Light Emitting Diodes

Radiant Intensity (I_e) has the dimensions of milliwatts per steradian. To calculate the irradiance at any distance, the following formula is applicable: $E_e = I_e/d^2$ mW/cm²

For example, a device with a radiant intensity of 150 mW/sr would produce an irradiance of 0.6 μ W/cm² at a 5 meter distance.

I_e is measured on axis at 36.3 mm from flange of the device. The detector is 6.35 mm diameter. For near field irradiance where the inverse square law does not apply, see the graphs showing relative irradiance vs. separation.

2. I_{FT} is the steady state forward current unless otherwise specified. When pulse conditions are specified, the forward drop is the peak value.
3. $\theta_{1/2}$ is angle between the optical axis and the half intensity μ sec, pulse repetition output beam pattern.
4. Pulse test current is 1.0 A peak. Pulse width is 100 μ sec, pulse repetition rate is 10 pps.

GaAs Infrared Emitting Diodes

TO-46 Flat Window Package — 940 nm

VTE1013

SUNSTAR传感器与控制 <http://www.sensor-ic.com/> TEL: 0755-83376549 FAX: 0755-83376182 E-MAIL: szss20@163.com

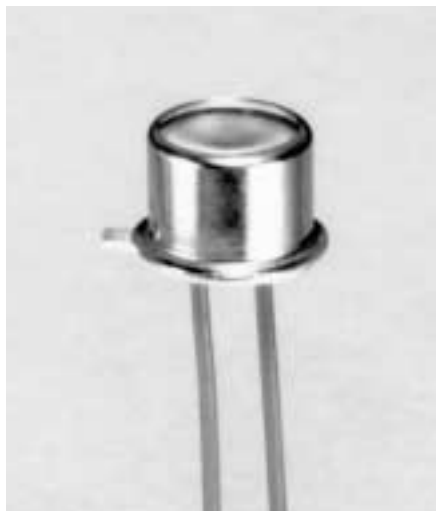

PACKAGE DIMENSIONS inch (mm)

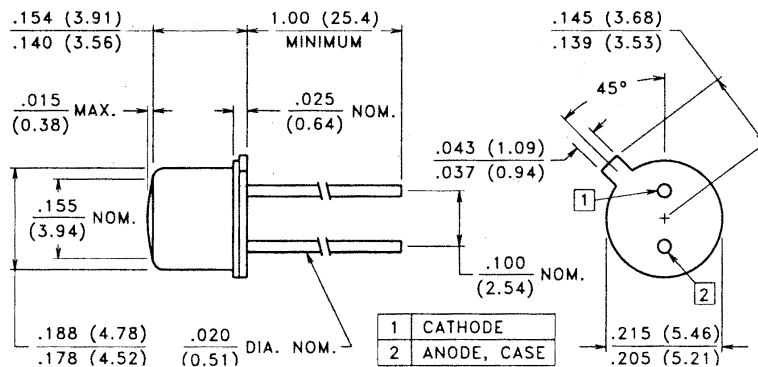

CASE 24A TO-46 HERMETIC (Flat Window)
CHIP SIZE: .018" X .018"

DESCRIPTION

This wide beam angle TO-46 hermetic emitter contains a large area, double wirebonded, GaAs, 940 nm IRED chip suitable for higher current pulse applications.

ABSOLUTE MAXIMUM RATINGS @ 25°C (unless otherwise noted) ■

Maximum Temperatures		Maximum Reverse Voltage:	5.0V
Storage and Operating:	-55°C to 125°C	Maximum Reverse Current @ $V_R = 5V$:	10 μA
Continuous Power Dissipation:	200 mW	Peak Wavelength (Typical):	940 nm
Derate above 30°C:	2.11 mW/°C	Junction Capacitance @ 0V, 1 MHz (Typ.):	35 pF
Maximum Continuous Current:	100 mA	Response Time @ $I_F = 20 mA$	
Derate above 30°C:	1.05 mA/°C	Rise: 1.0 μs Fall: 1.0 μs	
Peak Forward Current, 10 μs , 100 pps:	3.0 A	Lead Soldering Temperature:	260°C
Temp. Coefficient of Power Output (Typ.):	-8%/°C	(1.6 mm from case, 5 seconds max.)	

ELECTRO-OPTICAL CHARACTERISTICS @ 25°C (See also GaAIAs curves, pages 123-124)

Part Number ■	Output							Forward Drop		Half Power Beam Angle
	Irradiance		Radiant Intensity	Total Power	Test Current	V_F				
	E_e	Condition		I_e	P_O	I_{FT}	@ I_{FT}		$\theta_{1/2}$	
	mW/cm ²	distance	Diameter	mW/sr	mW	mA	Volts		Typ.	
	Min.	Typ.	mm	mm	Min.	Typ.	Typ.	Max.		
VTE1013	2.1	2.7	36	6.4	27	30	1.0	1.9	2.5	$\pm 35^\circ$

■ Refer to General Product Notes, page 2.



PACKAGE DIMENSIONS inch (mm)

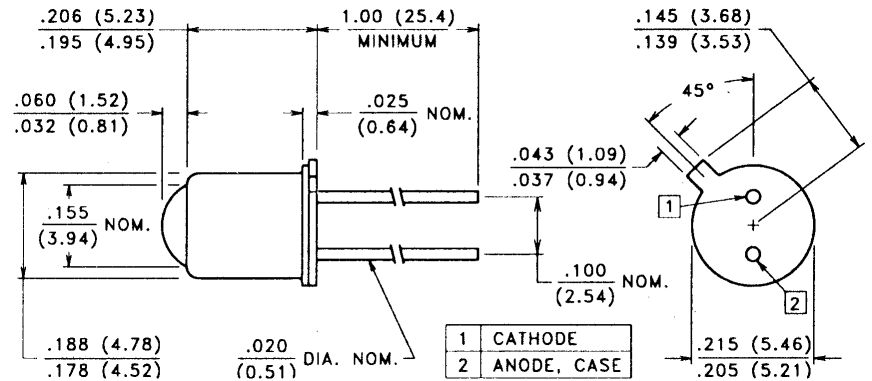

CASE 24 TO-46 HERMETIC (Lensed)
CHIP SIZE: .018" X .018"

DESCRIPTION

This narrow beam angle TO-46 hermetic emitter contains a large area, double wirebonded, GaAs, 940 nm IRED chip suitable for higher current pulse applications.

ABSOLUTE MAXIMUM RATINGS @ 25°C (unless otherwise noted) ■

Maximum Temperatures		Maximum Reverse Voltage:	5.0V
Storage and Operating:	-55°C to 125°C	Maximum Reverse Current @ $V_R = 5V$:	10 μA
Continuous Power Dissipation:	200 mW	Peak Wavelength (Typical):	940 nm
Derate above 30°C:	2.11 mW/°C	Junction Capacitance @ 0V, 1 MHz (Typ.):	35 pF
Maximum Continuous Current:	100 mA	Response Time @ $I_F = 20 mA$	
Derate above 30°C:	1.05 mA/°C	Rise: 1.0 μs Fall: 1.0 μs	
Peak Forward Current, 10 μs , 100 pps:	3.0 A	Lead Soldering Temperature:	260°C
Temp. Coefficient of Power Output (Typ.):	-8%/°C	(1.6 mm from case, 5 seconds max.)	

ELECTRO-OPTICAL CHARACTERISTICS @ 25°C (See also GaAlAs curves, pages 123-124)

Part Number ■	Output						Forward Drop		Half Power Beam Angle	
	Irradiance		Radiant Intensity	Total Power	Test Current	V_F				
	E_e		Condition		I_e	P_O	I_{FT}	@ I_{FT}	$\theta_{1/2}$	
	mW/cm ²		distance	Diameter	mW/sr	mW	mA (Pulsed)	Volts		Typ.
	Min.	Typ.	mm	mm	Min.	Typ.		Typ.	Max.	
VTE1113	12	15	36	6.4	156	30	1.0	1.9	2.5	$\pm 10^\circ$

■ Refer to General Product Notes, page 2.

GaAs Infrared Emitting Diodes

Long T-1 Plastic Package — 940 nm

VTE3322LA, 24LA

SUNSTAR传感器与控制 <http://www.sensor-ic.com/> TEL: 0755-83376549 FAX: 0755-83376182 E-MAIL: szss20@163.com



PACKAGE DIMENSIONS inch (mm)

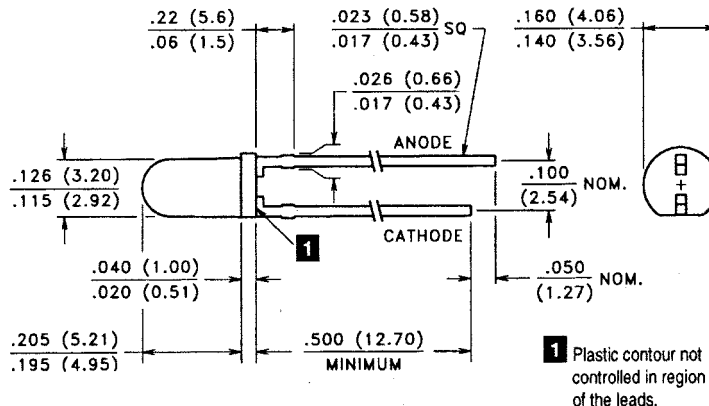

CASE 50A LONG T-1
CHIP SIZE: .011" X .011"

DESCRIPTION

This narrow beam angle, 3 mm diameter plastic packages, GaAs, 940 nm emitter is suitable for use in optical switch applications.

ABSOLUTE MAXIMUM RATINGS @ 25°C (unless otherwise noted) ■

Maximum Temperatures		Maximum Reverse Current @ $V_R = 5V$:	10 μA
Storage and Operating:	-40°C to 100°C	Peak Wavelength (Typical):	940 nm
Continuous Power Dissipation:	100 mW	Junction Capacitance @ 0V, 1 MHz (Typ.):	14 pF
Derate above 30°C:	1.43 mW/°C	Response Time @ $I_F = 20 mA$	
Maximum Continuous Current:	50 mA	Rise: 1.0 μs Fall: 1.0 μs	
Derate above 30°C:	0.71 mA/°C	Lead Soldering Temperature:	260°C
Peak Forward Current, 10 μs , 100 pps:	3 A	(1.6 mm from case, 5 seconds max.)	
Temp. Coefficient of Power Output (Typ.):	-8%/°C		
Maximum Reverse Voltage:	5.0V		

ELECTRO-OPTICAL CHARACTERISTICS @ 25°C (See also GaAlAs curves, pages 123-124)

Part Number	Output						Forward Drop		Half Power Beam Angle	
	Irradiance		Radiant Intensity	Total Power	Test Current	V_F				
	E_e	Condition		I_e	P_O	I_{FT}	@ I_{FT}	$\theta_{1/2}$		
	mW/cm ²	distance	Diameter	mW/sr	mW	mA	Volts			
	Min.	Typ.	mm	mm	Min.	Typ.	(Pulsed)	Typ.	Max.	Typ.
VTE3322LA	1.0	1.3	10.16	2.1	1.0	1.5	20	1.25	1.6	$\pm 10^\circ$
VTE3324LA	2.0	2.6	10.16	2.1	2.0	2.5	20	1.25	1.6	$\pm 10^\circ$

■ Refer to General Product Notes, page 2.

Application Notes

APPLICATION NOTE #1

Light - Some Physical Basics

Light is produced by the release of energy from the atoms of a material when they are excited by heat, chemical reaction or other means. Light travels through space in the form of an electromagnetic wave.

A consequence of this wave-like nature is that each "color" can be completely defined by specifying its unique wavelength. The wavelength is defined as the distance a wave travels in one cycle. Since the wavelengths of light are very short they are normally measured in nanometers, one nanometer being equal to 1×10^{-9} meters.

The spectral response of PerkinElmer Optoelectronics' photodetectors are specified by plots of relative response versus wavelength (color).

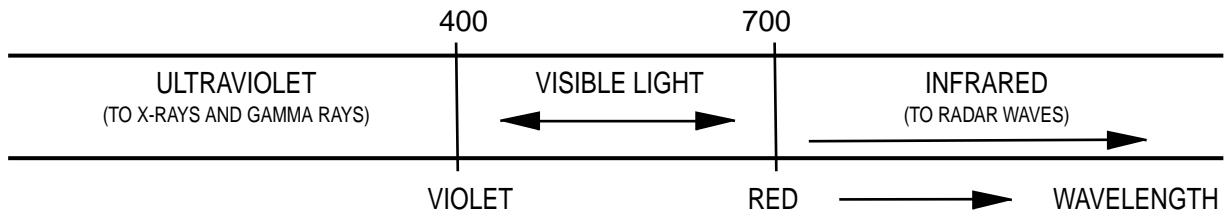

- VIOLET ----- BELOW 450 nm
- BLUE ----- 450 - 500 nm
- GREEN ----- 500 - 570 nm
- YELLOW ----- 570 - 590 nm
- ORANGE ----- 590 - 610 nm
- RED ----- 610 - 700 nm

NATURAL ILLUMINANCE

Sky Condition	Light Level (Typical)
Direct Sunlight	10000 fc
Overcast Day	1000 fc
Twilight	1 fc
Full Moon	.1 fc
Clear Night Sky (moonless)	.001 fc

ROOM ILLUMINATION

Lighting Condition	Light Level (Typical)
Candle - Lit Room	5 fc
Auditorium	10 fc
Classroom	30 fc
Inspection Station	250 fc
Hospital Operating Room	500 - 1000 fc

Application Notes

APPLICATION NOTE #2 Spectral Output of Common Light Sources

Incandescent lamps can be considered as black body radiators whose spectral output is dependent on their color temperature. The sun has approximately the same spectral radiation distribution as that of a black body @ 5900 K. However, as viewed from the surface of the earth, the sun's spectrum contains H₂O and CO₂ absorption bands.

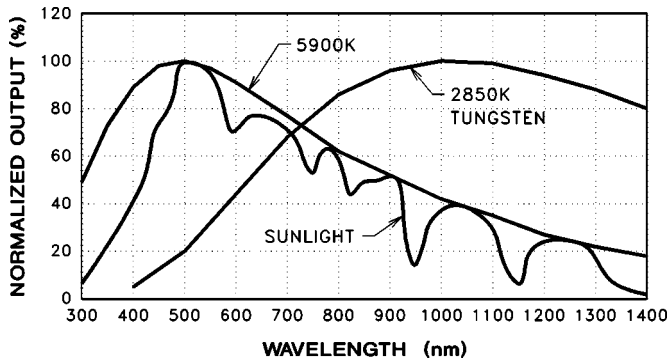

Black Body Sources Output vs Wavelength

Fluorescent lamps exhibit a broad band spectral output with narrow peaks in certain parts of the spectrum. Shown below is a plot of the light output of a typical daylight type fluorescent tube.

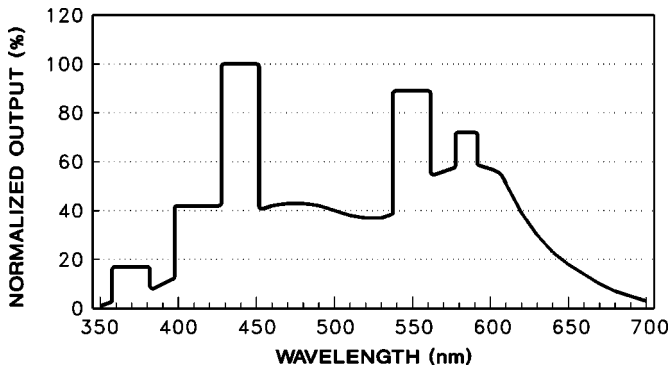

Fluorescent Lamp Output vs Wavelength

Due to their long operating lifetimes, small size, low power consumption, and the fact that they generate little heat, LEDs are the light sources of choice in many applications. When biased in the forward direction LEDs emit light that is very narrow in spectral bandwidth (light of one color). The "color" of the light emitted depends on which semiconductor material was used for the LED.

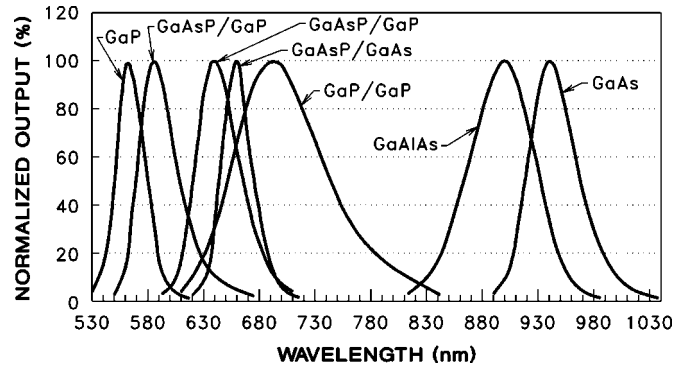

LED Light Sources

LED TYPE	COLOR	λ_p
GaP	GREEN	569nm
GaAsP/GaP	YELLOW	585nm
GaAsP/GaP	ORANGE	635nm
GaAsP/GaAs	RED	655nm
AlGaAs	RED	660nm
GaP/GaP	RED	697nm
GaAlAs	INFRARED	880nm
GaAs	INFRARED	940nm

Application Notes

APPLICATION NOTE #3

Photodiode Response Time

The response time of a photodiode is defined as the time it takes for light generated carriers within the body of the diode to arrive at and cross the P-N junction.

When the diode is illuminated, photons of light penetrate into the silicon and are absorbed generating electron-hole pairs. The average depth of penetration of a photon is wavelength dependent. The penetration depth has a statistical distribution so that there will be some electron-hole pairs generated at all depths. For light of very short wavelengths (ie UV and blue), most of the carriers will be generated very near the top surface of the diode. At this surface, due to the termination of the crystal lattice, the minority carrier lifetime is extremely short and most of the carriers will recombine before they can cross the P-N junction and contribute to the photocurrent. Light of longer wavelengths tends to penetrate deeper, generating a good number of carriers in the depletion region. The strong electric field that resides there sweeps the carriers across the junction at which point they contribute to the photocurrent. Light of even longer wavelengths (ie IR) penetrates even deeper generating carriers in the area below the depletion region. As these carriers slowly diffuse towards the P-N junction, a fair number will recombine and never contribute to the photocurrent. For photodiodes with long minority carrier lifetimes, a greater percentage of these carriers will survive to reach the junction.

The risetime of a photodiode consists of three components:

1. T_{CC} (charge collection time) is the time required for the electric field, residing at the P-N junction, to sweep out carriers generated within or entering the depletion region. Typically T_{CC} is less than 1 nsec.
2. T_{RC} (rise time associated with the RC time constant) is the time required to charge or discharge the photodiode's junction capacitance (C_J) through the external load resistance (R_L) and is given as:

$$T_{RC} = 2.2 R_L C_J$$

In practice the R_L term consists of the series combination of the external load resistance and internal series resistance of the photodiode (R_S). The C_J term should include not only the junction capacitance of the photodiode but also all external capacitance such as the packaging capacitance and the external wiring capacitance.

The series resistance of the photodiode (R_S) is comprised of the resistance of the undepleted region of the diode and the contact resistance. R_S is usually of the order of 10 ohms but can be up to a few hundred ohms in small area diodes of high resistivity silicon. When the output current of the photodiode is fed into a transimpedance op-amp the effective load resistance is the feedback resistance (R_F) divided by the open loop gain.

3. T_{DIF} (diffusion time) is the time needed for carriers generated outside the depletion region to diffuse into the depletion region. Carriers can diffuse into the depletion layer from the undepleted lower portion of the silicon chip as well as laterally from outside the perimeter of the active area of the chip.

The total risetime of a photodiode is equal to the square root of the sum of the squares of the three risetime components.

$$T_R = \sqrt{T_{CC}^2 + T_{RC}^2 + T_{DIF}^2}$$

T_R is essentially equal to the largest of the three risetime components.

The fastest response time will be achieved for the condition where the RC time constant is as small as possible and where all carriers are generated within the depletion region. What follows is a practical guideline for achieving these conditions.

1. Within the limits imposed by the application, select the process that results in the lowest value for junction capacitance per unit of active area.
2. Choose the photodiode with the smallest active area that still generates the required photocurrent.
3. Design the external circuit such that the load resistance the diode sees is as small as possible.
4. Apply a reverse voltage across the photodiode. This will expand the width of the depletion layer resulting in a larger percentage of carriers being generated within this region. The applied voltage will result in an increase in the electric field so that carriers within that field will experience an increase in drift velocity. Further, the junction capacitance will decrease with the increasing applied voltage.

Compiled below are some examples which illustrate how choice of light source, load resistance, and bias voltage effect the speed of a silicon photodiode. The numbers are produced by theoretical calculations, and numerous simplifying assumption have been made. Nevertheless these charts serve to show trends.

Application Notes

SLOWER DIODES	PARAMETER	HIGHER NOISE
LARGE	ACTIVE AREA	SMALL
LARGE	JUNCTION CAPACITANCE	SMALL
SMALL	REVERSE APPLIED VOLTAGE	LARGE
INFARED	LIGHT SOURCE	VISIBLE
LARGE	LOAD RESISTANCE	SMALL

$$T_R = \sqrt{T_{CC}^2 + T_{RC}^2 + T_{DIF}^2}$$

LIGHT SOURCE: RED LIGHT (660 nm)	SPEED (nsec.)							
	R _L = 50 ohms				R _L = 1000 ohms			
	T _{CC}	T _{RC}	T _{DIF}	T _R	T _{CC}	T _{RC}	T _{DIF}	T _R
V _R = 0V (C _J = 120 pF)	1	13	54	55.6	1	264	54	270
V _R = 10V (C _J = 24 pF)	1	2.6	0*	2.8	1	53	0*	53

* ALL CARRIERS ARE GENERATED WITHIN THE DEPLETION REGION

LIGHT SOURCE: RED LIGHT (940 nm)	SPEED (nsec.)							
	R _L = 50 ohms				R _L = 1000 ohms			
	T _{CC}	T _{RC}	T _{DIF}	T _R	T _{CC}	T _{RC}	T _{DIF}	T _R
V _R = 0V (C _J = 120 pF)	1	13	1448	1448	1	264	1448	1472
V _R = 10V (C _J = 24 pF)	1	2.6	97	97	1	53	97	110

Application Notes

APPLICATION NOTE #4 Modes of Operation - Photovoltaic vs. Photoconductive

A silicon photodiode can be operated in either the photovoltaic or photoconductive mode. When unbiased, the photodiode is being operated in the photovoltaic mode. When illuminated, the diode will generate a photocurrent which will divide between the internal shunt resistance of the junction and any external load resistance. That part of the photocurrent that flows through the external resistor will produce a voltage across that resistor which will act as a forward bias on the photodiode.

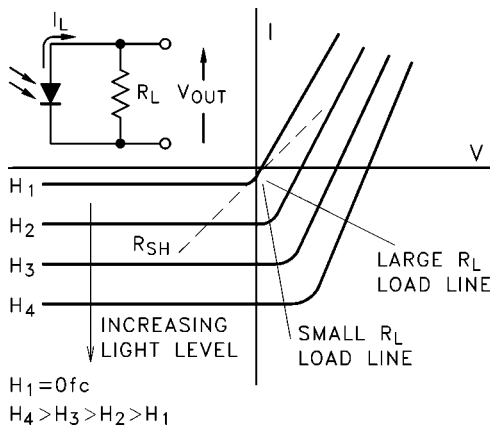

Current/Voltage Characteristics - Photovoltaic Mode

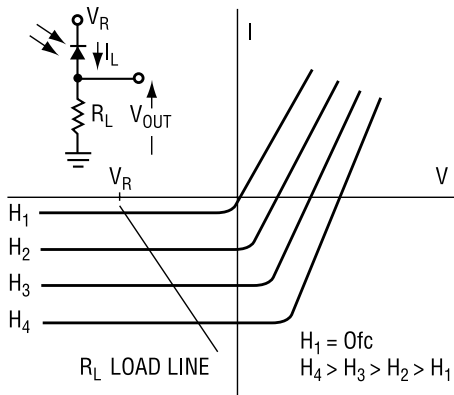

Current/Voltage Characteristics - Photoconductive Mode

When a reverse bias is applied, the photodiode is being operated in the photoconductive mode. In this mode the photodiode functions as a current source.

The choice of operating mode hinges on the trade-off between the required speed of response and the maximum noise that can be

tolerated in the actual application. As detailed in Application Note #3, applying a reverse bias across the photodiode increases its speed of response and must be used if nsec response times are needed. However, the dark leakage current of the photodiode tends to increase with applied reverse voltage resulting in an increase in the amount of shot noise generated by the photodiode. In general, a photodiode is operated in the photovoltaic mode when low noise is of prime concern, and under applied reverse bias when maximum speed is needed. A more detailed treatment on photodiode noise is given in Application Note #5.

APPLICATION NOTE #5 Photodiode Noise Characteristics

Certain figures of merit are defined to describe the performance of photodiodes:

- Spectral Responsivity (R_e)
- Radiant Sensitivity (S_R)
- Quantum Efficiency (QE)
- Rise Time (t_R)
- Cutoff Frequency (f_c)
- Shunt Resistance (R_{SH})
- Series Resistance (R_S)
- Junction Capacitance (C_j)
- Maximum Reverse Voltage (V_R max.)
- Dark Current (I_D)
- Short Circuit Current (I_{SC})
- Open Circuit Voltage (V_{OC})
- Noise Current (I_N)
- Noise Equivalent Power (NEP)
- Detectivity (D)

This application note will discuss the last three figures of merit: Noise Current (I_N), Noise Equivalent Power (NEP) and Detectivity (D).

Noise Current (I_N)

The equivalent circuit of a photodiode is shown below. It consists of an ideal current generator in parallel with an ideal diode. The junction capacitance, series resistance and the equivalent noise current generator associated with the junction shunt resistance account for the other photodiode parameters.

Application Notes

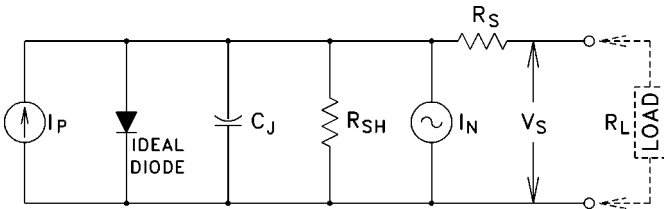

where:

- I_P = photocurrent generator (A)
- C_J = junction capacitance (F)
- I_N = noise current generator (A, rms)
- R_{SH} = shunt resistance (Ω)
- R_S = series resistance (Ω)
- V_S = signal voltage (V)
- R_L = load resistance (Ω)

Like other types of light sensors, the lower limits of light detection for photodiodes are determined by the noise characteristics of the device.

The main sources of noise in photodiodes are thermal noise (or Johnson noise), shot noise and flicker noise (1/f or contact noise). These noise sources are independent of each other and the total noise current is the root of the sum of the square of each of these noise sources.

Hence:

$$I_N = \sqrt{I_J^2 + I_S^2 + I_F^2}$$

where:

- I_N = total noise current (A)
- I_J = thermal or Johnson noise current (A)
- I_S = shot noise current (A)
- I_F = flicker noise current (A)

Thermal or Johnson Noise (I_J)

Thermal noise is a fundamental physical phenomenon generated by the random thermal motion of electrons and is present in any linear passive resistor. Photodiode thermal noise is caused by its shunt

resistance R_{SH} and is directly proportional to absolute temperature such that:

$$I_J = \sqrt{4kTB/R_{SH}}$$

where:

- I_J = Johnson noise (A)
- k = Boltzmann's constant (1.38×10^{-23} joules/K)
- T = absolute temperature (K)
- B = noise bandwidth (Hz)
- R_{SH} = photodiode shunt resistance (Ω)

In photodiodes, Johnson noise may become the dominant type when either low leakage/high dynamic resistance photodiodes are used in the zero bias configuration or when high value resistors (megohm to gigohm) are used as current sensing elements. Because thermal noise is independent of frequency and contains constant noise power density per unit bandwidth (B), it is considered white noise and is expressed in units of amps-per-root-Hertz (A/\sqrt{Hz}). For example, a photodiode having $R_{SH} = .5 \text{ M}\Omega$ at 25°C :

$$\begin{aligned} I_J/\sqrt{B} &= \sqrt{4kT/R_{SH}} \\ &= \sqrt{1.6 \times 10^{-20}/0.5 \times 10^6} \\ &= 0.18 \text{ pA (rms)}/\sqrt{\text{Hz}} \end{aligned}$$

Shot Noise (I_S)

Shot noise is generated by the random fluctuations in the normal current flow through the P-N junction. Because each electron carries a discrete amount of charge and the flow of electrons is subject to small random fluctuations, a noise current is generated. It has been shown that shot noise can be expressed by the following equation:

$$I_S = \sqrt{2qI_{dc}B}$$

where:

- I_S = shot noise (A, rms)
- I_{dc} = dc current through the junction
- q = electron charge (1.6×10^{-19} coulombs)
- B = noise bandwidth (Hz)

Application Notes

Like thermal noise, shot noise is independent of frequency and is also called "white noise". Shot noise may become significant when either high leakage photodiodes are used in reverse bias or when very weak signals must be detected. For example:

For a photodiode with $I_D = 100 \text{ nA}$, the resultant shot noise will be:

$$\begin{aligned} I_S / \sqrt{B} &= \sqrt{2qI_{dc}} \\ &= \sqrt{2 \times 1.6 \times 10^{-19} \times 100 \times 10^{-9}} \\ &= 0.18 \text{ pA (rms)} / \sqrt{\text{Hz}} \end{aligned}$$

Flicker or 1/f Noise

Flicker noise is one of the least understood. It is usually attributed to manufacturing noise mechanisms or device surface states. Experimental data shows that this type of noise has a dependence on dc current and is similar to shot noise. A general equation for this type of noise follows:

$$I_F = \sqrt{KI_{dc}B/f}$$

where:

I_F = flicker noise (A)

K = a constant that depends on the type of material and its geometry.

I_{dc} = dc junction current (A)

B = bandwidth of interest (Hz)

f = frequency (Hz)

Unlike thermal and shot noises, flicker noise has 1/f spectral density and in the ideal case for which I_f is exactly proportional to $\sqrt{1/f}$, it is termed "pink noise". Unfortunately, the constant (K) can only be determined empirically and may vary greatly even for similar devices. Flicker noise may dominate when the bandwidth of interest contains frequencies less than about 1 kHz.

Noise Equivalent Power (NEP)

The lower limit of light detection for a photodiode is expressed as the intensity of incident light required to generate a current equal to the noise current, I_N . This limit is referred to as Noise Equivalent Power, NEP and is defined as follows:

$$\text{NEP} = I_N / S_R$$

where:

NEP = noise equivalent power ($\text{W} / \sqrt{\text{Hz}}$)

I_N = noise current ($\text{A} / \sqrt{\text{Hz}}$)

S_R = peak radiant sensitivity (A/W)

NEP values range from about $10^{-15} \text{ W} / \sqrt{\text{Hz}}$ for small area, low noise silicon photodiodes, to over $10^{-12} \text{ W} / \sqrt{\text{Hz}}$ for large area cells. PerkinElmer's VTB (blue enhanced series) and VTP (fast response series) are among the lowest noise photodiodes with NEP values on the order of $10^{-15} \text{ W} / \sqrt{\text{Hz}}$, and the VTS (solar processed, large area series) photodiode NEP values are on the order of $10^{-13} \text{ W} / \sqrt{\text{Hz}}$.

Detectivity (D)

The inverse value of NEP is the detectivity (detection capability). The detectivity is a measure of the least detectable radiant power or detector signal to noise ratio. A higher D indicates ability to detect lower levels of radiant power.

$$D = 1/\text{NEP}$$

where:

$$D = \text{detectivity} (\sqrt{\text{Hz}}/\text{W})$$

Since noise is normally proportional to the square root of the photosensitive area, the smaller the photosensitive area (A_D), the better the apparent NEP and detectivity.

The specific detectivity D^* (D-Star) takes account of this factor and produces a figure of merit which is area independent. By definition:

$$D^* = D \times \sqrt{A_D}$$

where:

D^* = specific detectivity ($\text{cm}\sqrt{\text{Hz}}/\text{W}$)

A_D = photodiode active area

D^* values range from as high as $10^{13} (\text{cm}\sqrt{\text{Hz}}/\text{W})$ to as low as $10^{11} (\text{cm}\sqrt{\text{Hz}}/\text{W})$.

Both NEP and D^* may be expressed either as an absolute or relative with respect to values at a given wavelength or at peak sensitivity.

Application Notes

Photodiode Noise Measurement

Photodiode noise current can be measured directly. A very low noise, high gain, broadband current to voltage converter amplifier is required along with a band pass filter and a true rms volt meter. A typical measurement circuit is shown below.

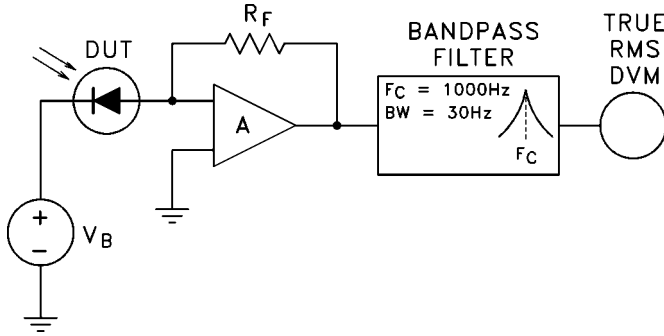

where:

DUT = photodiode under test

V_B = variable low noise dc power supply

A = low noise broadband amplifier

R_F = feedback resistor

NOTE: A wave analyzer with true rms read out can be used in place of bandpass filter and true rms DVM.

Test Procedure

Set wave analyzer frequency span @ 1 kHz and resolution bandwidth @ 30 Hz.

Connect the output of amplifier A to the wave analyzer input.

Adjust the well regulated and low noise power supply to set the required bias voltage.

Measure the system noise, N_S, by inserting a capacitance equal to the photodiode's junction capacitance, C_J, at the operating reverse bias voltage between power supply and amplifier.

Replace the above capacitance by the photodiode and measure the system plus Photodiode noise, N_S + N_D.

Calculate the photodiode's current noise (I_N) as follows:

Photodiode noise voltage

$$N_D = \sqrt{(N_S + N_D)^2 - N_S^2}$$

where:

N_D = photodiode noise voltage (V)

N_S = system noise voltage (V)

Photodiode noise current

$$I_N = N_D / (R_F \times \sqrt{B})$$

where:

R_F = feedback resistor (ohms)

B = bandwidth (Hz)

Photodiode noise equivalent power

$$NEP = I_N / S_R$$

Detectivity

$$D = 1 / (NEP)$$

$$D^* = D \times \sqrt{A_D}$$

LOWER NOISE	PARAMETER	HIGHER NOISE
SMALL	ACTIVE AREA	LARGE
LARGE	SHUNT RESISTANCE	SMALL
SMALL	DARK CURRENT	LARGE
SMALL	JUNCTION CAPACITANCE	LARGE

APPLICATION NOTE #6 Processes

Photodiodes find use in a wide range of applications because they can be made with a wide range of performance characteristics. Each application places different demands on their performance.

It is often desirable to enhance one or more of the photodiode's performance characteristics such as sensitivity to a particular wavelength of light, speed of response, shunt resistance, etc. Within certain constraints this can be accomplished through the choice of method of crystal growth, resistivity, crystal orientation, carrier lifetime, and other properties of the silicon wafer as well as through wafer processing and photodiode chip layout.

PerkinElmer offers three standard silicon diode processes. Each process represents a different trade-off in diode performance characteristics. The following charts list the three standard processes and illustrate the tradeoffs.

Application Notes

PROCESS	DESCRIPTION
VTB VTP	PACKAGED DEVICES BLUE ENHANCED FAST RESPONSE
VTS	LARGE AREA DEVICES LOW CAPACITANCE

Diode Characteristics

VTB PROCESS	PARAMETER	VTP PROCESS
LOWER	SR@2850K	HIGHER
HIGHER	SR@400nm	LOWER
HIGHER	V_{OC}	LOWER
LOWER	I_D	HIGHER
HIGHER	R_{SH}	LOWER
HIGHER	C_J	LOWER
LOWER	V_{BR}	HIGHER

APPLICATION NOTE #7

Array and Custom Detector Guidelines

Semicustom and fully custom photodiodes can be used to deliver performance not available from catalog devices. PerkinElmer offers a full spectrum of specialized or custom services ranging from the sorting of stock devices for some electrical characteristic such as V_{BR} , R_D , or I_D ; to placing a stock chip in a package it is not usually supplied in; to the use of filters incorporated into the package in order to modify the spectral response; to a totally custom chip and/or package design involving a major tooling effort.

LEVEL OF CUSTOMIZING	WHEN JUSTIFIED	NOTES
CUSTOM ELECTRICAL SORT OF EXISTING STOCK DEVICE	MODERATE VOLUMES	QUICK TURN-AROUND
SUPPLY EXISTING CHIP IN A DIFFERENT PACKAGE	HIGH VOLUMES	LONGER LEAD TIMES, NRE*
TOOL CUSTOM CHIP AND/OR TOOL CUSTOM HOUSING	HIGH VOLUMES	LONGEST LEAD TIMES, NRE, TOOLING

* NRE - NON RECURRING ENGINEERING CHARGE

PerkinElmer also has the capability to design and manufacture custom multichannel arrays of various configurations. There are two general categories of arrays: monolithic and hybrid. Monolithic arrays have all detector elements incorporated within one silicon chip. Hybrid arrays are arrays assembled by placing individual detector chips down onto some sort of substrate, usually ceramic or printed circuit board.

Tooling costs and lead times can become a major concern if a monolithic array chip must be made from scratch. A possible alternative, should the geometries work out, is to cut out a block of discrete photodiode chips from the parent silicon wafer, thus eliminating the need to tool a custom array. However, for this approach to work, an existing detector chip must be found not only with the same active area as a single element of the array, but the spacing between the diodes on the wafer must be the same as the center-to-center spacing required for the array.

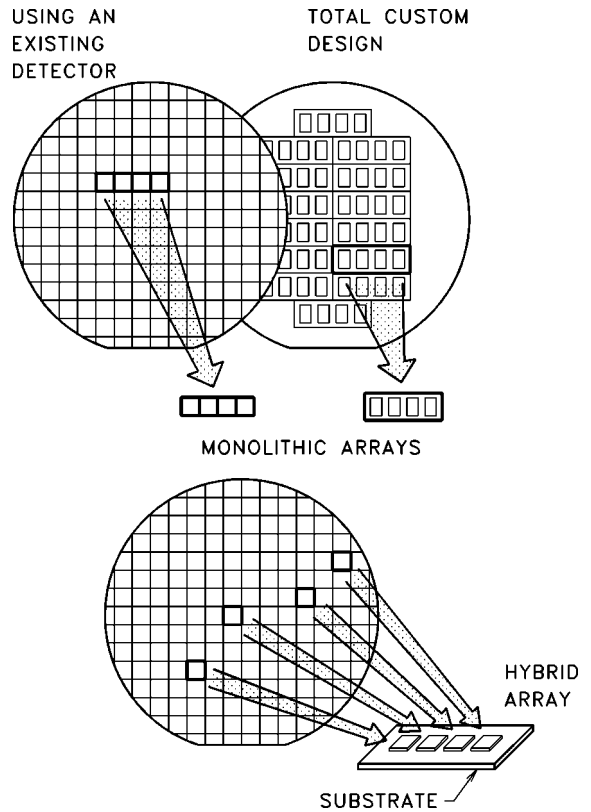

Application Notes

Comparison of Monolithic and Hybrid Arrays

MONOLITHIC	PARAMETER	HYBRID
COMMON CATHODE	ELECTICAL CONFIGURATION	FLEXIBLE
LESS (ONE CHIP)	COMPLEXITY OF PACKAGE	MORE (MULTIPLE CHIPS)
LONGER*	LEADTIMES	SHORTER
LESS	PACKAGING COSTS	**MORE
TIGHTER	DIMENSIONAL TOLERANCES	LOOSER

* TOTAL CUSTOM DESIGN

** PATTERNED METALLIZED SUBSTRATE OFTEN NEED TO BE TOOLED

Since arrays tend to be custom in nature, it is important for the customer to supply PerkinElmer with enough information to achieve the most cost effective design for the particular application. The information required includes the following:

1. Number of light detecting elements
2. Desired layout
3. Active area of each element
4. Center-to-center spacing between elements
5. Electrical configuration (common cathode, etc.)
6. Packaging requirements - including pin-out configuration
7. Anticipated volumes
8. Price goals
9. Desired delivery date

APPLICATION NOTE #8

Photometric and Radiometric Terms

In order to describe the sensitivity of photodetectors or the brightness of light sources, it is necessary to define the amount of light being emitted or detected in quantitative terms. Many individuals, when first

exposed to these terms, experience a certain amount of confusion caused by the two systems of measurement, the photometric and the radiometric.

The photometric system defines light in terms of how it is perceived by the human eye. The eye's sensitivity is dependent on the wavelength or color of the light. Peak sensitivity occurs in the green part of the visible spectrum while the eye's response to infrared or ultraviolet is zero.

The radiometric system describes light quantities in physical rather than eye response terms. The baseline detector used in the radiometric system has uniform sensitivity across the entire spectrum. Radiometric measurements can be made with thermopiles whose response does not vary with wavelength.



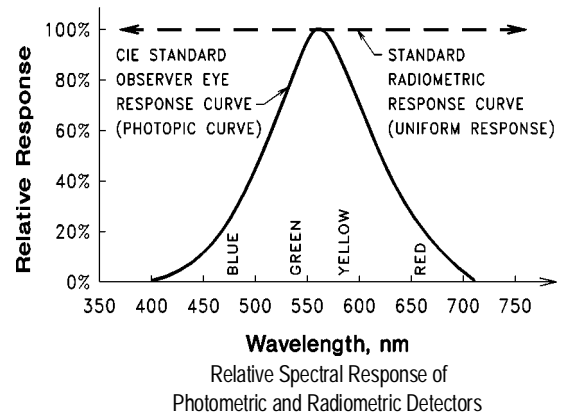

Both systems have their place. When specifying room lighting, it makes sense to use photometric units. However, if the application involves transmitting data over a beam of infrared light, the output of the light source and the sensitivity of the detector must be specified using radiometric units.

PerkinElmer makes use of the symbol H, (the original term for radiant incidence) when specifying the lighting conditions under which its detectors are measured for sensitivity. This symbol appears regardless if photometric (fc) or radiometric (W/cm²) incidence is being specified.

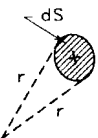

Application Notes

Commonly Used Terms

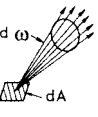
TERM	DEFINITION	NOMENCLATURE	DESCRIPTION	EQUATION	UNITS
 Flux, Φ	Rate of flow of energy (Q) to, from or through a surface	Φ_e - (Radiometric)	Radiant Flux (Radiant Power)	$\frac{dQ_e}{dt}$	W, Watts
		Φ_v - (Photometric)	Luminous Intensity	$\frac{dQ_v}{dt}$	lm, lumens
 Incidence, E (Note 1)	Flux per unit area falling perpendicularly upon a surface	E_e - (Radiometric)	Radiant Incidence (Irradiance)	$\frac{d\Phi_e}{dA}$	W/cm ²
		E_v - (Photometric)	Luminous Incidence (Note 2)	$\frac{d\Phi_v}{dA}$	lx, lux (lm/m ²)
 Exitance, M	Flux per unit area from an emitting surface	M_e - (Radiometric)	Radiant Exitance (Emittance)	$\frac{d\Phi_e}{dA}$	W/m ²
		M_v - (Radiometric)	Luminous Exitance	$\frac{d\Phi_v}{dA}$	lm/m ²
 Solid Angle, ω	A solid angle with its apex at the center of a sphere of radius, r , defines a spherical surface area, S , such that $\omega=S/r^2$			$d\omega = \frac{dS}{r^2}$	sr, Steradians
 Intensity, I	Flux per unit solid angle radiating from a point source	I_e - (Radiometric)	Radiant Intensity	$\frac{d\Phi_e}{d\omega}$	W/sr
		I_v - (Photometric)	Luminous Intensity	$\frac{d\Phi_v}{d\omega}$	cd, candelas (lm/sr)
 Sterance, L	Flux per unit solid angle per unit area of emitting surface at angle θ with respect to the surface normal	L_e - (Radiometric)	Radiant Sterance (Radiance)	$\frac{d\Phi_e}{dA \cos \theta}$ $\frac{d^2\Phi_e}{d\omega dA \cos \theta}$	W/(sr m ²)
		L_v - (Photometric)	Luminous Sterance (Luminance) (Note 3)	$\frac{d\Phi_v}{dA \cos \theta}$ $\frac{d^2\Phi_v}{d\omega dA \cos \theta}$	cd/m ²

Notes:

- For historical continuity, PerkinElmer uses the symbol "H" in the data sheets of this catalog.
- Other units for luminous intensity are:
 Phot, ph lm/cm²
 Footcandle, fc lm/ft² (1 fc = 10.76 lux)

- Other units for luminous sterance are:
 Lambert, L 1/πcd/cm²
 Foot lambert, fL 1/πcd/ft²
 Apostilb, asb 1/πcd/m²
 Stilb, sb cd/cm²

Application Notes

APPLICATION NOTE #9

The Effect of Packaging on the Light Output of IREDs

When an IRED is forward biased a percentage of the injected carriers which recombine in the vicinity of the P-N junction result in the generation of photons. Not all of the generated light is able to emerge from the interior of the IRED chip due to these power loss mechanisms:

1. absorption
2. Fresnel losses
3. internal reflection

Mounting the IRED die in a package not only serves to protect it from a potentially hostile environment but can also be used to increase the useful power output by compensating for these losses. As photons travel outward through the chip from the junction region there is a probability that absorption will take place. The longer the travel distance the greater the internal absorption. This is the reason that smaller IRED sizes exhibit the highest power conversion efficiencies.

Because the P-N junction extends to and is exposed at the four sides of the chip, a large percentage of the total light output is emitted from these sides. By mounting the IRED chip in a contoured cavity it is possible to collect a larger percentage of this side emitted light and reflect it upwards.

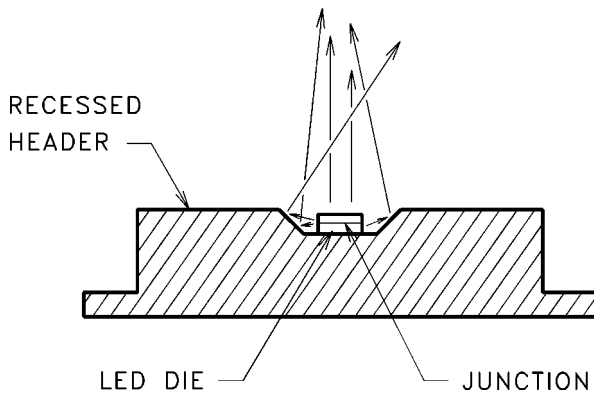

When light travels from a material with index of refraction n_1 into a medium with index of refraction n_2 some of the light is reflected back at

the interface between the two materials. This reflected power is called the fresnel loss.

For normal incidence, the Fresnel loss efficiency factor is given by:

$$\eta_{FR} = \frac{4}{n_2^2 + n_2/n_1 + n_1/n_2}$$

where:

n_1 = index of refraction of the IRED
 n_2 = index of refraction of the material surrounding the chip

For a GaAs IRED chip emitting directly into air:

$$\eta_{FR} = \frac{4}{(1 + 1/3.62) + (3.62/1)} = 82\%$$

Hence only 82% of the light reaching the chip's surface exits the chip. More light power can be extracted from the chip by coating it with a matching material whose index of refraction lies between that of the chip's and that of air. When an "index matching" material is used the transmission efficiency can be increased to over 90%. Optimum transmission efficiency is achieved when the index matching material used has an index of refraction of $\sqrt{n_1 n_2}$.

Loss also occurs due to total internal reflection. If photons of light are incident to the chip's surface at angles greater than the critical angle they are reflected back into the crystal.

$$\theta_C = \sin^{-1}(n_2/n_1) @ 16^\circ \text{ (for GaAlAs)}$$

where:

θ_C = critical angle
 n_1 = index of refraction of the LED
 n_2 = index of refraction of the material surrounding the chip

This situation can be improved by coating the LED chip with a plastic encapsulant.

Application Notes

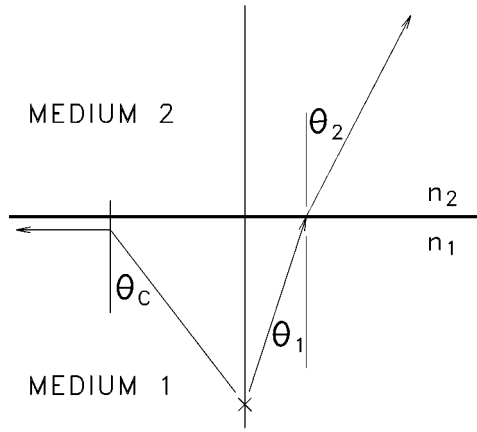

$$\begin{aligned} \theta_c &= \sin^{-1}(n_2/n_1) \\ &= \sin^{-1}(1.30/3.62) \\ &\cong 21^\circ \end{aligned}$$

Lenses, incorporated into the IRED package, can be used to increase the useable forward power intensity by focusing the light emitted by the IRED.

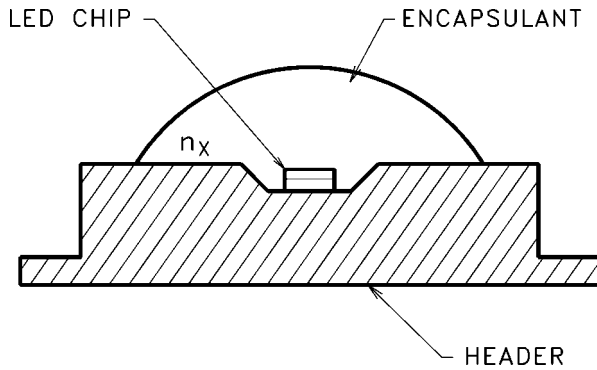

The lenses used on metal/glass hermetic packages are made from a glass whose thermal coefficient of expansion closely matches that of the Kovar (iron-nickel-cobalt alloy) package. For IREDs which use leadframe construction, lenses can be made an integral part of the cast of molded package.

The lenses used on IRED are not precision ground. Expect variations in the light pattern from unit to unit due to lens quality, variations in chip placement, shape of the reflector cavity, number and type of material interfaces, and distance from the lens to the IRED chip.

The glass lens used in hermetic packages is formed by melting and reflowing a cut glass disc. The overall dimensions and geometry of this

reflowed lens show considerable variation. They do not have closely repeatable optical geometry. The focal point, direction, and uniformity of the emitted beam of light show significant variation from unit to unit.

Plastic IREDs have only one optical surface in the lens system. The shape of this lens is controlled by the casting mold or transfer mold. The optical characteristics are more uniform from unit to unit. So, plastic IREDs have a more consistent beam pattern than hermetic IREDs.

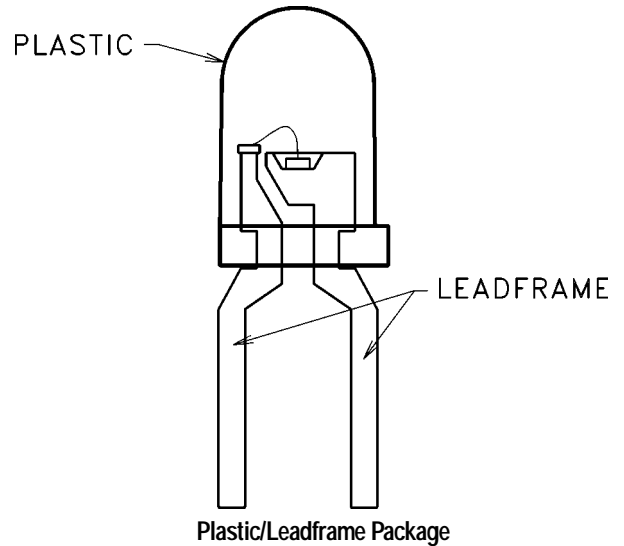
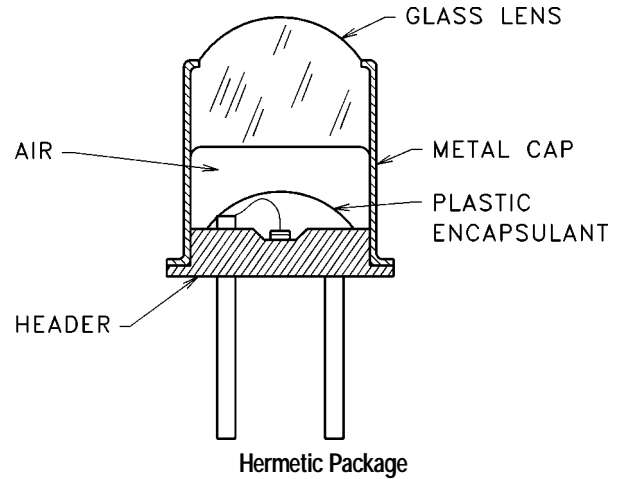

IREDs of plastic/leadframe package design have two fewer dielectric interfaces than do IREDs in hermetic packages. As a result plastic packages generally deliver up to 50% more useable focused power than hermetic packages.

Application Notes

APPLICATION NOTE #10

Characterization of IRED Power Output

Almost all applications have an optical geometry containing a detector of a certain physical area that intercepts a portion of a "beam" of IR power emitted by the IRED.

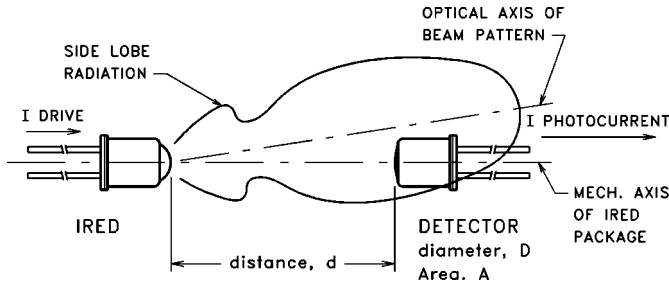

This note explains the conceptual relationship between this basic geometry and several ways used to measure and sort IREDs in manufacturing.

Total Power Output:

This is the quantity which is easiest to measure with a high degree of reproducibility. The measurement set-up consists of some physical approximation to an integrating sphere. Nearly all of the power emitted by the IRED is collected and measured.

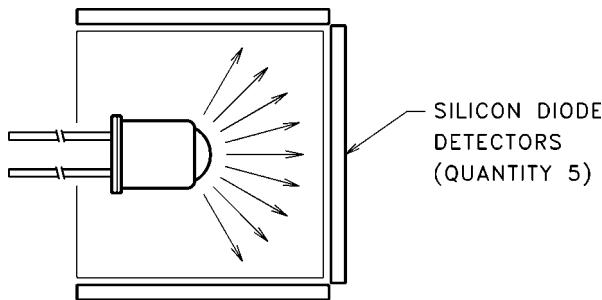

Advantages:

- Easy to get reproducible measurements
- Independent of optical irregularities in the IRED lens
- Independent of variations in mechanical positioning of the IRED under test.

Disadvantage:

- Total power output does not describe the beam pattern of the IRED (spatial distribution of emitted power). It provides incomplete information for the optical designer.

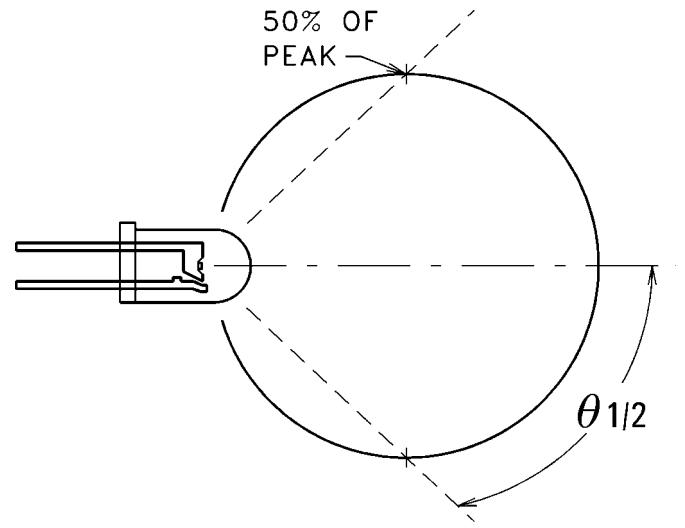

Wide Angle IRED

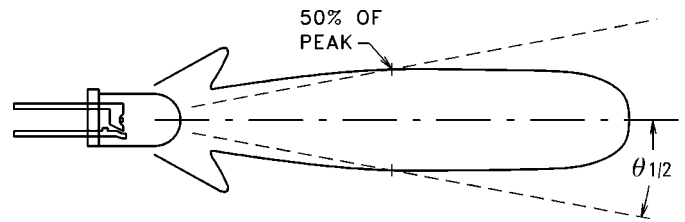

Narrow Angle IRED

Manufacturers commonly rate their IREDs by "power output" in milliwatts at a specified drive current. However, the specs will also include a "half power beam angle", $\theta_{1/2}$. The half power beam angle can be used as a semi-quantitative guide to predict the behavior of the IRED in a given application. Within certain limits, "narrow angle" IREDs will contain more power in their "beam" than "wide angle" IREDs.

Radiant Intensity

Radiant intensity is defined as:

$$I_e = \Delta W / \Delta \omega$$

where:

$$\omega = \text{acceptance angle in steradians}$$

and is normally applied to the "far field" radiation pattern where the IRED can be approximated as a point source of power (viewing distance is at least ten times greater than the IRED lens diameter). Since it is defined in terms of power per solid angle, the radiant intensity is independent of the distance from the IRED.

Application Notes

In practice, the radiant intensity is measured by clamping the body of the IRED (thus establishing its "mechanical axis") and measuring the output of a photodetector of diameter "D". The solid angle is:

$$\omega \equiv (\pi/4 D^2)/d^2$$

and the IREDs are sorted into radiant intensity bins of "xx" mW/sr. It is important that the solid acceptance angle of the measuring apparatus be small enough to produce an essentially constant irradiance over the surface of the detector. Otherwise, different diameter detectors will produce different measured values of "radiant intensity". Generally, the measuring solid angle is in the vicinity of 0.01 sr (steradians). Each manufacturer usually lists the steradian value of the test apparatus in the data sheet footnotes.

Advantages of Radiant Intensity Measurement:

- The designer can use Radiant Intensity quantitatively in many different design situations.
- IREDs which exceed a minimum Radiant Intensity value will usually show more consistent performance in the customer's application.

Disadvantages of Radiant Intensity Measurement:

- It is hard to get highly reproducible measurements of Radiant Intensity. This is because it is difficult to establish the mechanical axis of the IRED reproducibly. The optical and mechanical axis of the IRED under test almost never coincide. The IRED bodies are tapered and never exactly circular. This leads to slight variations in the position of the IRED in the measuring apparatus each time it is measured. Increased scatter in the measured values of Radiant Intensity is the result. In practice, Radiant Intensity is useful as a minimum specification only.
- Many applications of IREDs use a close spacing between the IRED and detector. Thus, Radiant Intensity — which is measured in the "far field" (spacing at least ten times IRED diameter) does not quantify the available power to be coupled from the IRED.

Irradiance:

Irradiance is defined by the power which passes through an aperture (usually circular, diameter D) which is spaced at a distance "d" from the tip of the IRED's lens. Usually, both the aperture diameter "D" and the distance "d" are chosen to have values that are representative of many (but, unfortunately, not all) applications. Thus, Irradiance is a very

practical—but geometry dependent—quantity. It should be noted that Irradiance has a precise mathematical definition in geometrical optics and is easy to calculate in the case of a sufficiently small diameter detector moved into the far field radiation pattern of the IRED.

Typical cone angles are in the range of 10 to 30 degrees. Larger cone angles give more reproducible measurements. However, larger cone angles reduce the absolute accuracy of the irradiance measurement since the radiant flux density (power density) emitted by the IRED is usually not constant over a large diameter.

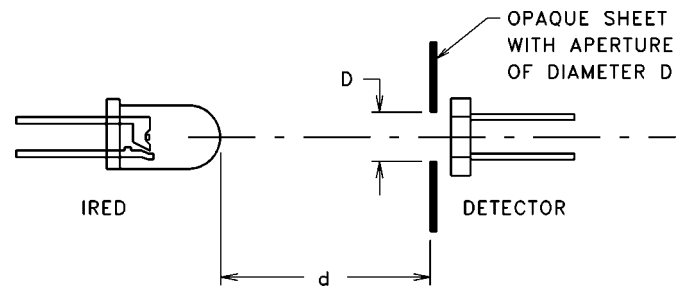

Equivalent to:

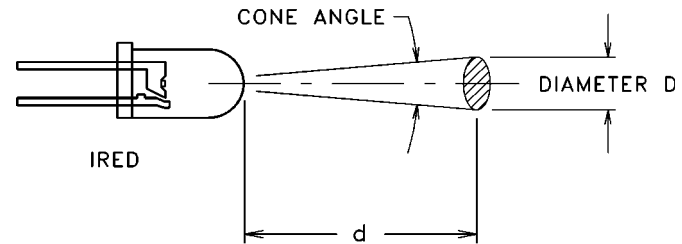

Irradiance can be calculated from the Radiant Intensity in the far field ($d/D > 10$) from the relationship:

$$E_e = I_e / d^2$$

In summary:

Total Power Output is conventionally used throughout the industry to specify IREDs. It has the highest measurement reproducibility.

Radiant Intensity is useful as a far field ($d/D > 10$) specification but has no use close to the IRED lens. Radiant Intensity is hard to measure accurately because of difficulty in locating and clamping the mechanical axis of the IRED.

Application Notes

Irradiance is a useful measurement technique in the near field of the IRED's beam pattern. Measuring the power through an aperture of diameter "D" spaced distance "d" from the IRED lens tip approximates many real-life application geometries. If the aperture "D" is large compared to the spacing "d" (large cone angle), the reproducibility of the irradiance measurement is improved, but, the absolute accuracy is decreased.

APPLICATION NOTE #11 IRED Axial Power Out Measurement

The on-axis power emitted by an IRED is measured by placing a detector, with a given active area, at some distance in front of the IRED and recording the average power falling upon the surface of that detector. The on-axis power is defined as an average power since more light might fall upon one portion of the detector than another.

For example, a silicon photodiode with $S_r @ 880 \text{ nm} = .5 \text{ A/W}$ is being used to measure the on-axis power of a GaAlAs IRED. When a current meter is attached to the diode, a short circuit current, I_{SC} , of $50 \mu\text{A}$ is read.

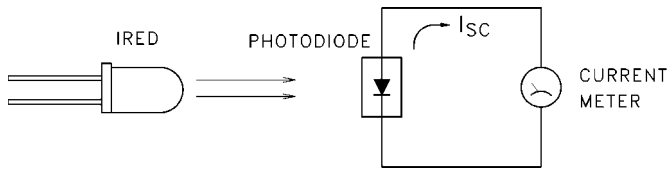

$$\text{On-Axis Power} = 50 \mu\text{A} \div 0.5 \text{ A/W} = 100 \mu\text{W}$$

Thus, $100 \mu\text{W}$ of power is incident on the photodiode. It might all fall on one portion or it might be evenly distributed over the entire surface of the detector.

The measurement of on-axis power is informative and could be used to compare the output of IREDs in packages of the same lens type. However, it does nothing to help the designer who needs to know what their magnitude of output can be expected from a detector of a different active area and sensitivity positioned at different distances from the IRED.

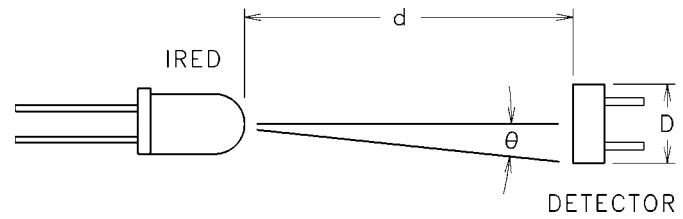

To perform these calculations, the designer needs to know the on-axis power intensity of the IRED. The on-axis power intensity can be stated as an irradiance, $E_e \text{ (mW/cm}^2\text{)}$ or as a radiant intensity, $I_e \text{ (mW/sr)}$. We will deal with radiant intensity shortly, for the moment let's study irradiance and how the diameter of the detector used and distance from the emitter to detector affects the detector.

The graph presented below illustrates the relationship between E_e and the size of the detector used to make the measurement. If the diameter of the detector is a good deal smaller than the distance between the detector and the IRED being measured, then E_e is independent of the size of the detector.

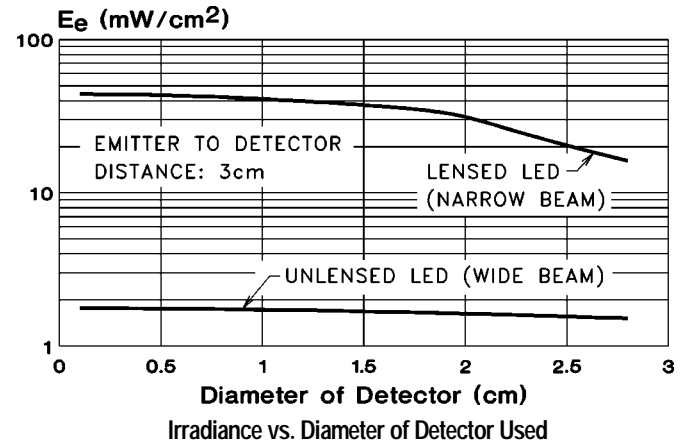

In most practical cases, spacing (d) is much larger than detector diameter (D). The E_e obtained is then an accurate quantity, independent of the optical geometry and can be used to calculate the output signal for detector/IRED combinations.

Here is an example of such a calculation.

A silicon photodiode with an active area of $.100" \times .100"$ and an $S_r @ 880 \text{ nm} = 0.5 \text{ A/W}$ is positioned 6 cm in front of a lensed IRED and then in front of an IRED with no focusing lens. The total power output of each IRED is identical. What is the output signal from the detector for both cases?

Application Notes

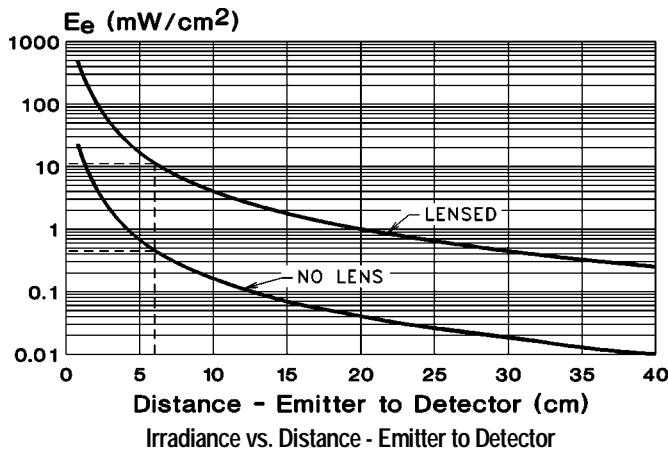

From the graph, the E_e for both IRED/detector combinations can be found.

For the case of the lensed IRED:

$$I_{SC} = .5 A/W \times .0645 \text{ cm}^2 \times 11 \text{ mW/cm}^2 = 355 \mu\text{A}$$

For the case of the unlensed IRED:

$$I_{SC} = .5 A/W \times .0645 \text{ cm}^2 \times .44 \text{ mW/cm}^2 = 14.2 \mu\text{A}$$

In some cases the Irradiance vs. Distance curve may not provide data at the separation distance(s) of interest, or the curve itself may not be available. In such situations, if the irradiance is known at one distance of separation, E_e can be calculated by use of the inverse square law.

$$E_e @ d_2 = E_e @ d_1 / [d_2/d_1]^2$$

For example, let's consider the output signal from the photodiode/lensed IRED pair used above when they are 30 cm apart.

$$E_e = 11 \text{ mW/cm}^2 / [30 \text{ cm} / 6 \text{ cm}]^2 = .44 \text{ mW/cm}^2$$

$$I_{SC} = .5 A/W \times .0654 \text{ cm}^2 \times .44 \text{ mW/cm}^2 = 14.2 \mu\text{A}$$

Note: The inverse square law assumes that the light source (IRED) appears as a "point" source to the detector. In practical terms this

means that the diameter of the light source is less than 1/10 the distance between the emitter and detector.

As already mentioned, on-axis power intensity can also be described in terms of radiant intensity, I_e . Radiant intensity defines on-axis power intensity as power per solid angle (mW/sr). The concept of a solid angle is described by the figure below.

A cone of a solid angle ω , has its apex at the center of a sphere of radius R and defines an area A, on that sphere as that

$$\omega = A / R^2 \cong \pi r^2 / R^2 \quad (\text{sr})$$

The unit of measurement is the steradian (sr).

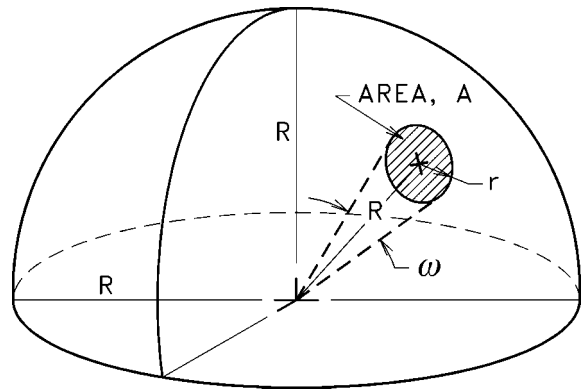

Example: A photodiode, with a circular active area .50 cm in diameter and sensitivity @ 880 nm of .5 A/W, is located 10 cm in front of a GaAlAs IRED whose $I_e = 100 \text{ mW/sr}$. The value of the detector's short circuit current can be calculated as:

$$\begin{aligned} \omega &= \pi r^2 / R^2 \\ &= \pi \times (.50 \text{ cm} / 2)^2 / (10 \text{ cm})^2 \\ &= .001963 \text{ (sr)} \end{aligned}$$

$$I_{SC} = .5 A/W \times 100 \text{ mW/sr} \times .001963 \text{ sr} = 98.15 \mu\text{A}$$

APPLICATION NOTE #12 IREDs With Narrow Beam Patterns

A wide angle IRED distributes its radiant flux as shown below. Most of the flux impinges on the lens surface at almost normal incidence. Little is lost to total internal reflection.

Application Notes

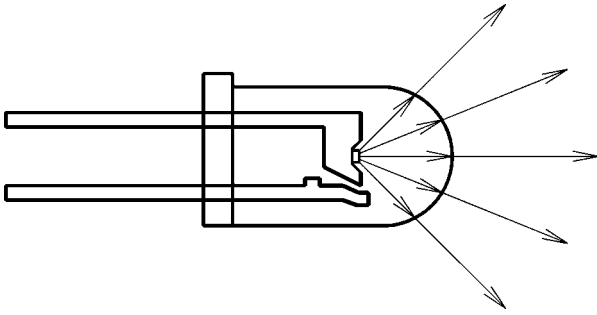

Some of the radiant flux in narrow angle IREDs is reflected internally.

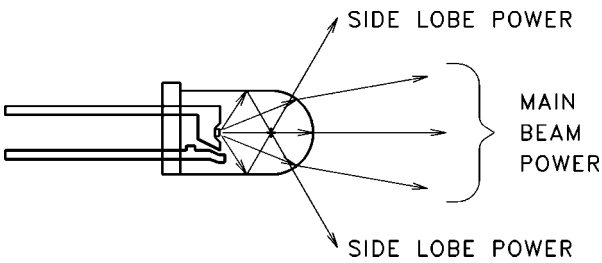

The side lobe power is not useful in most applications. It is "lost" to the optical system. Typical emission patterns (beam patterns) are shown below in both polar and rectangular coordinates.

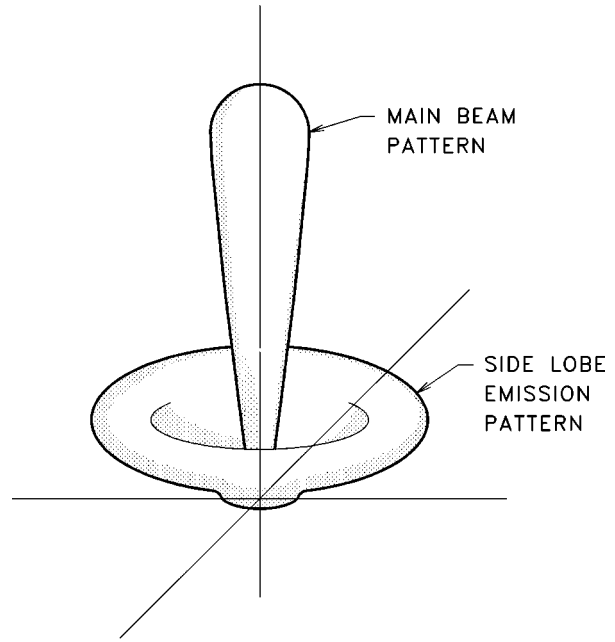
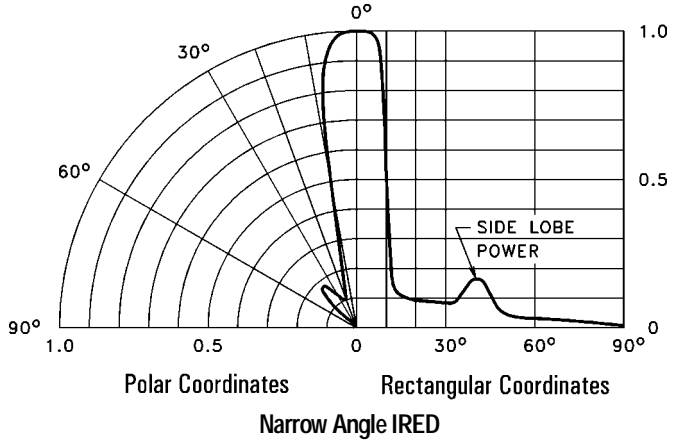

3-D Representation of Emission Pattern of Narrow Beam IRED

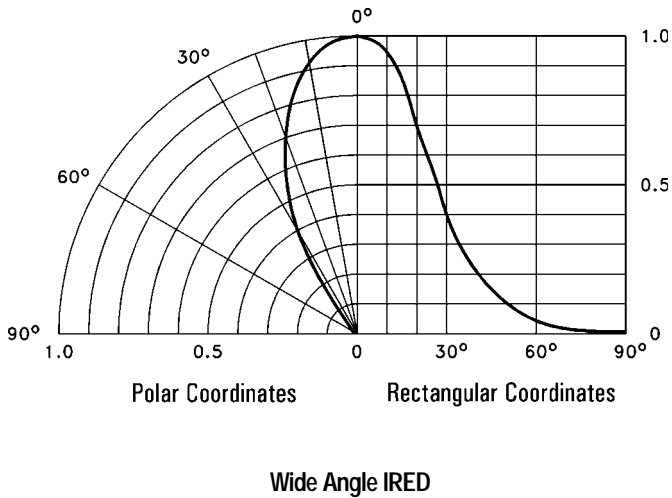

Wide Angle IRED

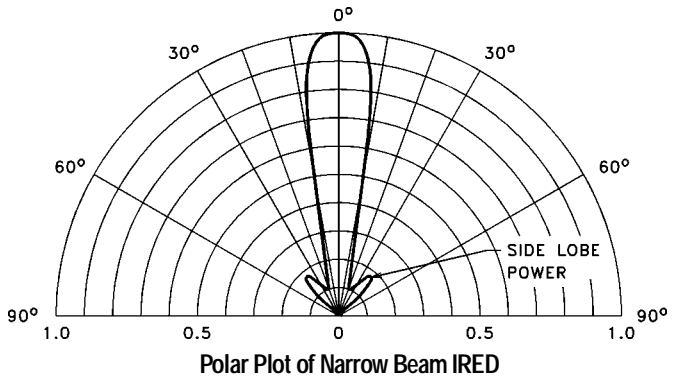

Polar Plot of Narrow Beam IRED

Application Notes

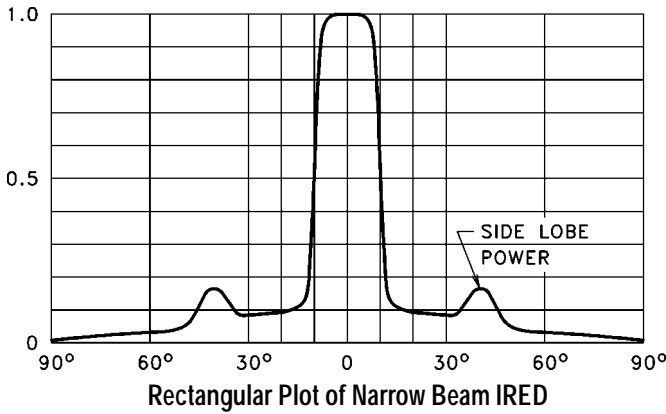

The side lobes have less peak intensity than the main beam (particularly when viewed in rectangular coordinates). However, the side lobes subtend a much larger solid angle than does the main beam. The net result is that in narrow beam IREDs, the side lobes can actually contain most of the power emitted by the narrow beam IRED. This side lobe power is lost to the main beam and is not useful in the optical system. Thus, the peak radiant intensity increases (mW/sr), but the useful main beam power decreases (mW/cm²) as the beam width is made narrower.

MAIN BEAM HALF POWER ANGLE	APPROXIMATE FRACTION OF TOTAL POWER APPEARING IN SIDE LOBES
40 to 60°	NEGLIGIBLE
20°	10 to 20%
10°	20 to 30%
5°	40 to 60%

Applications that require maximum useful power and a narrow beam should use a wide angle LED coupled to an external lens to maximize the power coupled into the optical system.

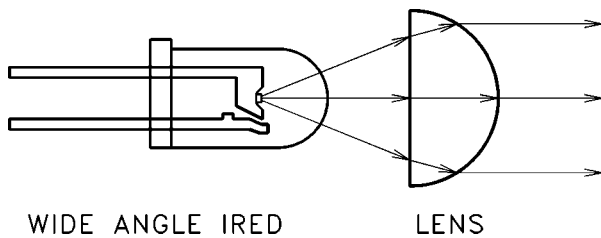

APPLICATION NOTE #13 Biasing IREDs and Phototransistors

The light generated by an IRED is directly proportional to the forward current flowing through the device. Various biasing schemes can be used to set the value of the current. Some are illustrated below.

DC Bias

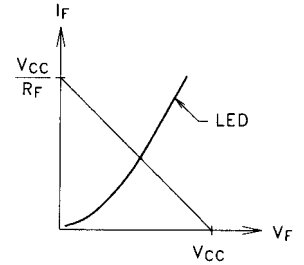
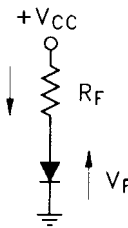

$$I_F = V_{CC} - V_F / R_F$$

$$R_F = V_{CC} - V_F / I_F$$

Example: Select R_F such that $I_F = 20$ mA for a GaAlAs IRED. $V_{CC} = 5$ V

From the data sheets:

$$V_{F(TYP)} @ I_F = 20 \text{ mA}: 1.25 \text{ V}$$

$$\therefore R = (5 - 1.25) \text{ V} / 20 \text{ mA} = 187.5 \Omega$$

Closest standard resistor value = 180 Ω

$$\therefore I_{F(TYP)} = (5 - 1.25) / 180 \approx 21 \text{ mA}$$

AC Bias

When AC biasing an IRED, it is important to prevent the applied IRED voltage from exceeding the maximum rated reverse voltage to avoid damaging the IRED.

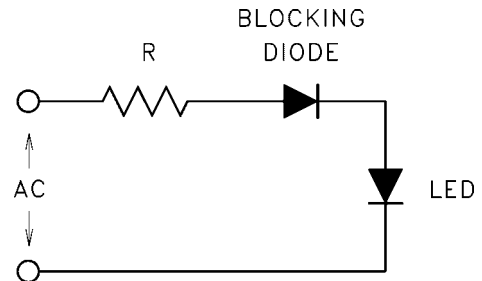

Application Notes

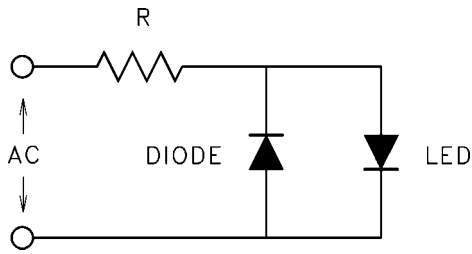

For circuit interfacing, phototransistors can be treated as any general purpose small signal transistor. The only exception being that phototransistors are driven by incident light rather than by an applied base current.

While capable of linear operation over a limited range of light intensities, phototransistors are normally used as a switch. As such, the designer is primarily concerned with the two boundary conditions; the equivalent "on" and "off" positions.

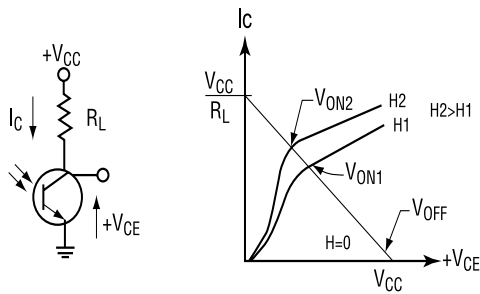

Position	Ideal	Actual
"OFF" Position	V_{CC}	$(V_{CC} - R_L I_{DARK})$
"ON" Position	0	$V_{CE(SAT)}$

Note that $V_{CE(SAT)1} > V_{CE(SAT)2}$.

At times it may be necessary to extend the voltage or current capacity of the phototransistor.

Current capacity can be increased by using the phototransistor to drive a second transistor (Darlington arrangement).

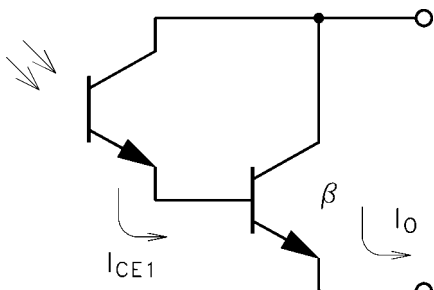

$$I_O \cong \beta I_{CE1}$$

The following approach can be used to switch a voltage greater than the V_{BRCEO} of the phototransistor. The highest collector-emitter voltage seen by the phototransistor is the base-emitter voltage of the high voltage transistor.

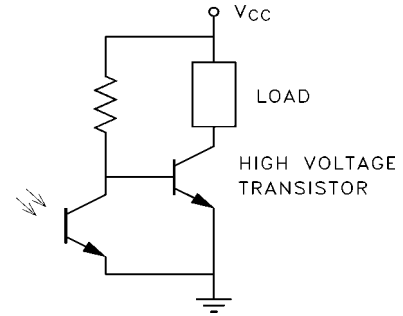

APPLICATION NOTE #14

Discrete Chips - An Alternative Solution to Space Problems

Space restrictions may preclude the use of packaged detectors or emitters in some applications. In these cases the use of discrete chips might be appropriate because of their small size. PerkinElmer offers IREDs and phototransistors in unpackaged die form—ready for hybrid assembly. Chips are supplied loose in vials, in waffle pack chip carriers, or as probed and inked wafers.

Conductive silver epoxy is commonly used for die attach. This method involves dispensing tightly controlled amounts of the epoxy either manually or with automatic equipment. The chip is placed on the epoxy which is then cured at moderate temperatures.

Connections are made to the metallized contact pads on the top surface of the chip by bonding very fine wires of aluminum or gold from these pads to the package. Typically, thermosonic ball or ultrasonic wedge wire bonding is used.

After wire bonding, the chip must be protected from the environment by either sealing it within an appropriate housing or by coating the chip with a clear epoxy or silicone designed for coating semiconductor die. This prevents moisture and contaminants from attacking the chip and wirebonds.

PerkinElmer offers assembly services for those customers who are not equipped for hybrid circuit manufacturing.

Application Notes

Detector Chips (Dice)

PerkinElmer's stock chips are 100% probed for dc current gain, dark current, collector & emitter breakdown voltages, and collector-emitter saturation voltage. PerkinElmer can also provide special testing to meet your custom requirements.

Emitter (E) and Base (B) aluminum metallized bond parts are provided on the top surface of every phototransistor and photodarlington chip. Some devices also have a collector bond pad on the top surface of the die. For all chips, contact to the collector can be made through the backside of the die, the entire surface of which is metallized with nickel.

Custom single and multichannel detectors can be tooled if stock devices are unable to meet the requirements of your application.

Emitter (IRED) Chips

PerkinElmer's stock IRED chips are sample probed for forward voltage at a given current drive, reverse leakage current, and power output. Light output cannot be measured for individual chips while they are in wafer form.

Anode contact is made through the backside (bottom) of the chip. Cathode contact is available through the bonding pad(s) on the top surface. A gold metallization system is employed on both the top and bottom surfaces.

Silver conductive epoxy is recommended for die attach. Thermosonic gold ball bonding is recommended for the top contact.

Special note on die attach epoxy "slop". Remember: all high efficiency output IR emitting dice have an electrically exposed P-N junction that appears on all four sides of the die. Conductive epoxy placed or "slopped" over the P-N junction can cause a total, partial, or even a time-varying electrical short circuit of the IRED die.

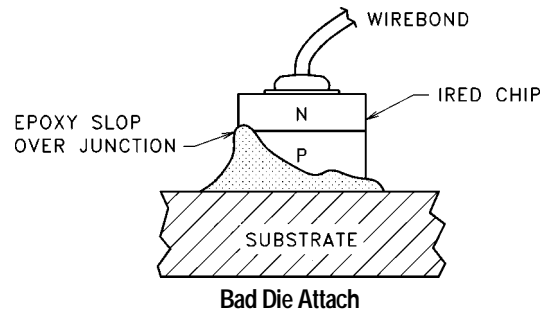
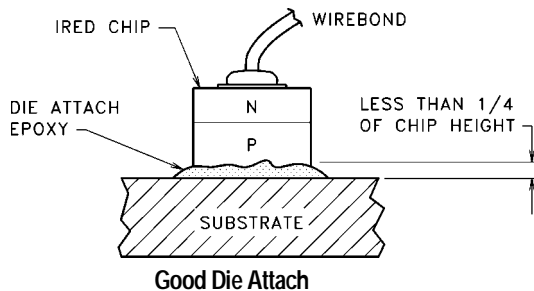

Always use very small amounts of die attach epoxy. Keep the maximum epoxy height less than 1/4 of the height of the IRED chip.

APPLICATION NOTE #15

Handling and Soldering Opto Components

Care must be taken in the handling and soldering of all opto components, especially those that use a cast or molded plastic and lead frame construction.

In lead frame type construction, the detector chip is mounted directly to one lead and a wire bond is made from the chip to the other lead. The encapsulating plastic is the only support for the lead frame. Unlike the familiar black plastic IC packages, clear opto epoxies have no fiberglass filler. Thus, they are not as strong as plastic IC packages. Care must be taken when forming the leads of plastic opto packages. Excessive mechanical force can cause the leads to move inside the plastic package and damage the wire bonds. Weakened bonds can then "open up" under further mechanical or thermal stressing, producing open circuits.

In order to form leads safely, it is necessary to firmly clamp the leads near the base of the package in order not to transfer any force (particularly tension forces) to the plastic body.

This can be accomplished either through use of properly designed tooling or by firmly gripping the leads below the base of the package with a pair of needle nose pliers while the leads are being bent.

Application Notes

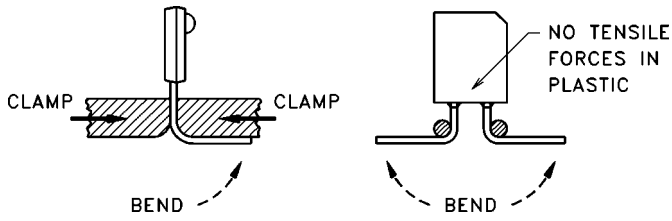

Examples of Tooling Fixtures Used to Form Leads

For highest reliability, avoid flush mounting the plastic body of the printed circuit board. This minimizes mechanical stresses set up between the circuit board and the plastic packages. It also reduces solder heat damage to the plastic package.

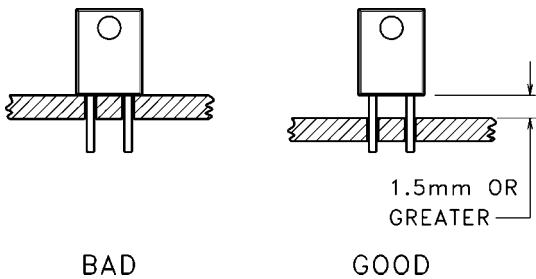

Good printed circuit board layout avoids putting spreading (plastic under tension) force of the leads of a plastic package.

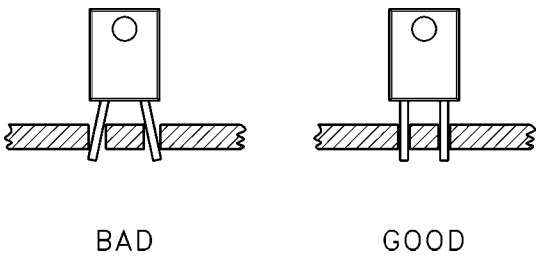

When hand soldering, it is important to limit the maximum temperature of the iron by controlling the power. It is best if a 15W or 25W iron is used. The maximum recommended lead soldering temperature (1/16" from the case for 5 seconds) is 260°C. An RMA rosin core solder is recommended.

Sn60 (60% tin/40% lead) solder is recommended for wave soldering opto components into printed circuit boards, other alternatives are Sn62 and Sn63. The maximum recommended soldering temperature is 260°C with a maximum duration of 5 seconds. The amount of tarnish

on the leads determines the type of flux to use when soldering devices with silver plated leads.

Condition of Leads	Recommended Flux
Clear Bright Finish (Tarnish Free)	RMA - Mildly Activated
Dull Finish (Minimal Tarnish)	RMA - Mildly Activated
Light Yellow Tint (Mild Tarnish)	RA - Activated
Light Yellow/Tan Color (Moderate Tarnish)	AC - Water Soluble, Organic Acid Flux
Dark Tan/Black Color (Heavy Tarnish)	Leads Need to be Cleaned Prior to Soldering

Cleaners designed for the removal of tarnish from the leads of electronic components are acidic and it is best to keep to immersion time as short as possible (less than 2 seconds) and to immediately wash all devices thoroughly in ten rinses of deionized water.

The best policy is one which prevents tarnish from forming. Tarnish, which is a compound formed when silver reacts with sulfur (Ag_2S), can be prevented by keeping the components away from sulfur or sulfur compounds. Since two major sources of sulfur are room air and paper products, it is best to store the devices in protective packaging such as "silver saver" paper or tightly sealed polyethylene bags.

After soldering, it is necessary to clean the components to remove any rosin and ionic residues. For a listing of recommended cleaning agents please refer to Application Note # 16.

APPLICATION NOTE #16 Recommended Cleaning Agents

PerkinElmer offers many devices in a number of package styles which employ a wide range of construction techniques. Package styles include:

1. hermetically sealed glass/metal packages
2. cast and molded leadframe packages
3. ceramic or metal headers covered with a layer of clear epoxy (blob-top construction).

Some packages are more resistant to attack by chemical cleaning than others. Blob-top construction is the least resistant. Cast or molded leadframe packages offer better resistance. Of course, the glass/metal hermetic packages are the most chemically resistant of all.

Application Notes

RECOMMENDED	NOT RECOMMENDED
ARKLONE A	ACETONE
ARKLONE K	CARBON TETRACHLORIDE
ARKLONE F	METHYL ETHYL KETONE
BLACO-TRON DE-15	METHYLENE CHLORIDE
BLACO-TRON DI-15	TRICHLOROETHYLENE (TCE)
FREON TE	XYLENE
FREON TES	TRICHLOROETHANE FC-111
FREON TE-35	TRICHLOROETHANE FC-112
FREON TP	FREON TF
FREON TF-35	FREON TA
GENESOLV D	FREON TMC
GENESOLV DE-15	FREON TMS
GENESOLV DI-15	GENESOLV DA
ISOPROPYL ALCOHOL	GENESOLV DM
WATER	GENESOLV DMS

In many cases the devices will be exposed to a post solder cleaning operation which uses one or more solvents to remove the residual solder flux and ionic contaminants. Only certain cleaning solvents are compatible with the plastics typically used in optoelectronic device packages.

This listing of recommended/not-recommended solvents represents only a very small percentage of available chemical cleaning agents. Even with this list of recommended solvents it is important to be aware that:

1. Solvent exposure times should be as short as possible.
2. The exact requirement of the cleaning process will vary from customer to customer and application to application.
3. Additives and concentrations will vary from supplier to supplier.

Because of these uncertainties, our recommendation is that all customers carefully evaluate their own cleaning process and draw their own conclusions about the effectiveness and reliability of the process. PerkinElmer cannot assume any responsibility for damage caused by the use of any of the solvents above or any other solvents used in a cleaning process.