

HPS A02B

Pyroelectric Single Element Detector for Measurement Applications

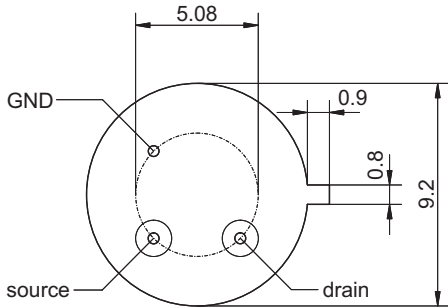

bottom view

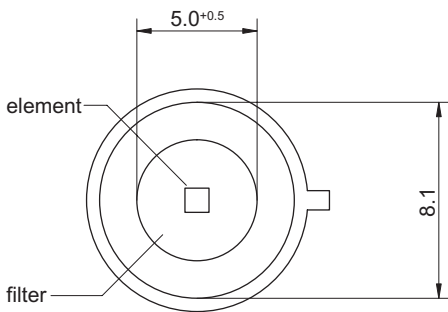
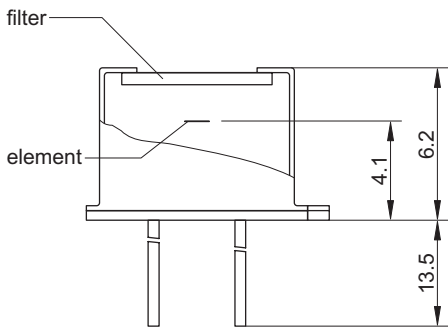

element size	1 mm × 1 mm
aperture	5.0 ^{+0.5} mm
filter ³	Ge* or Si* (8–14 μm)
responsivity ^{1,2}	> 900 V/W
noise ¹	< 160 nV/√Hz
specific detectivity ^{1,2}	> 6 · 10 ⁸ cm √Hz/W
offset voltage	0.4–1.5 V
operating voltage	2–18 V
housing	TO 39
operating temperature	–20 to 70 °C
storage temperature	–20 to 70 °C

1) frequency: 10 Hz, detector temperature: 25 °C

2) blackbody source temperature: 500 K, filter transmission: 100 %

3) other filters on request

