

## Tactile Switch (Sealed SMD Type)

## B3SN

### Designed as Surface-mounting Device (SMD) Meeting High-density Mounting Requirements

- SMD Tactile Switch ideal for high-density mounting.
- Compact and more than 1 mm thinner than conventional tactile switches.
- Available with ground terminals for protection against static electricity.
- Sealed construction conforming to IP64 (IEC-529) provides high reliability in dusty or humid environments.

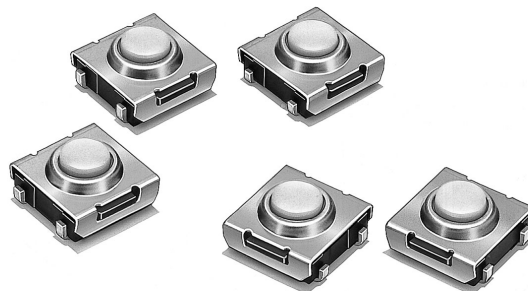

## Ordering Information

### ■ List of Models

Type	Bags	Embossed tape (see note)
Without ground terminal	B3SN-3012	B3SN-3012P
With ground terminal	B3SN-3112	B3SN-3112P

**Note:** Switches in bags must be ordered in units of 100 pieces, and Switches on embossed tape must be ordered in units of 3,000 pieces.

### ■ Operating Characteristics

Operating force (OF)	1.57±0.49 N {160±50 gf} max.
Releasing force (RF)	0.29 N {30 gf} min.
Pretravel (PT)	0.25±0.15 mm

## Specifications

### ■ Ratings/Characteristics

Switching capacity	1 to 50 mA, 5 to 24 VDC (resistive load)
Ambient temperature	Operating: -25°C to 70°C (with no icing)
Ambient humidity	Operating: 35% to 85%
Contact configuration	SPST-NO
Contact resistance	100 mΩ max. (initial value) (rated: 1 mA, 5 VDC)
Insulation resistance	100 MΩ min. (at 250 VDC)
Dielectric strength	250 VAC, 50/60 Hz for 1 min
Bounce time	5 ms max.
Vibration resistance	Malfunction: 10 to 55 Hz, 1.5-mm double amplitude
Shock resistance	Destruction: 1,000 m/s <sup>2</sup> {approx. 100G} max.
Life expectancy	100,000 operations min.
Weight	Approx. 0.2 g

# Nomenclature

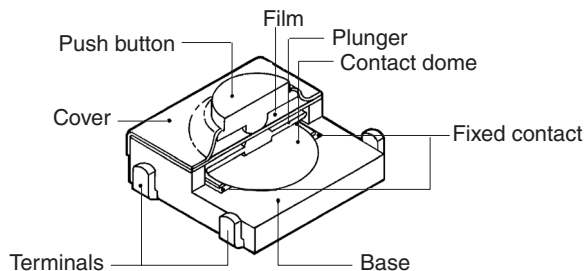

# Dimensions

- Note:**
1. All units are in millimeters unless otherwise indicated. Unless otherwise specified, a tolerance of  $\pm 0.4$  mm applies to all dimensions.
  2. No terminal numbers are indicated on the Switches. The numbers used for terminals in the following graphics are indicated in the "Bottom View" diagram below. In this diagram, the Switch is rotated so that the terminals are on the right and left-hand sides, and the OMRON logo appears the right way up.



## Without Ground Terminal

B3SN-3012  
B3SN-3012P

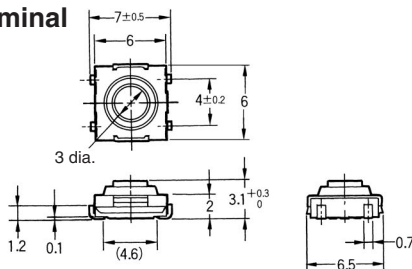
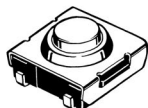

## PCB Mounting (Top View)

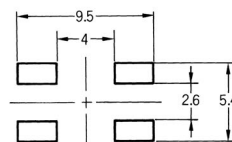

## Terminal Arrangement /Internal Connections (Top View)

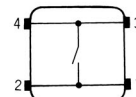

## With Ground Terminal

B3SN-3112  
B3SN-3112P

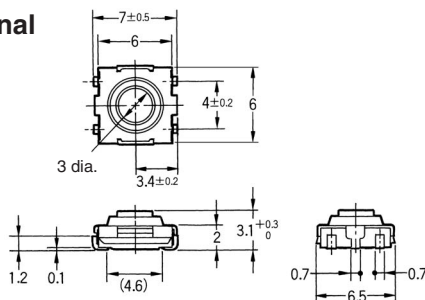
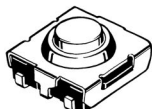

## PCB Mounting (Top View)

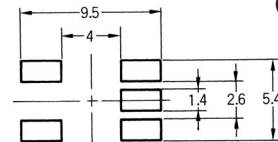

## Terminal Arrangement /Internal Connections (Top View)

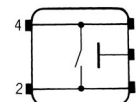

# Precautions

Be sure to read the precautions common to all Tactile Switches on pages 5 to 7 for correct use.

**ALL DIMENSIONS SHOWN ARE IN MILLIMETERS.**  
To convert millimeters into inches, multiply by 0.03937. To convert grams into ounces, multiply by 0.03527.