

NAIS**AUTOMOTIVE LOW PROFILE
MICRO-ISO/MICRO-280
RELAY****CV-RELAYS**

Micro ISO 1c type



Micro ISO 1a type



Micro 280 plug-in type



Micro 280 PCB type

FEATURES

- **Low profile:**
22.5 mm(L)×15 mm(W)×15.7 mm(H)
.886 inch(L)×.591 inch(W)×.618 inch(H)
- **Low temperature rise**
Terminal temperature has been reduced compared with using our conventional product
- **Low sound pressure level**
Noise level has been reduced approx.10dB compared with using our conventional product.

- **Wide line-up**
Micro ISO/Micro 280 terminal types and resistor and diode inside type, PCB terminal type (Micro 280 only).
- **Plastic sealed type**
Plastically sealed for automatic cleaning.

SPECIFICATIONS**Contact**

Arrangement		1 Form A	1 Form C
Contact material		Silver alloy	
Initial contact resistance, max. (By voltage drop 6 V DC 1 A)		50mΩ	
Initial contact voltage drop, max.		N.O.: 0.2 V (at 20 A switching)	N.O.: 0.2 V (at 20 A switching) N.C.: 0.5 V (at 10 A switching)
Rating	Nominal switching capacity	N.O.: 20 A 14 V DC	N.O.: 20 A 14 V DC N.C.: 10 A 14 V DC
	Max. carrying current (14 V DC, at 85°C 185°F)	N.O.: 20 A	N.O.: 20 A N.C.: 10 A
Expected life (min. operation)	Mechanical (at 120 cpm)	Min. 10 ⁶	
	Electrical (at rated load)	Min. 10 ^{5*1}	

Remarks

- * Specifications will vary with foreign standards certification ratings.
^{*1} At nominal switching capacity, operating frequency: 2s ON, 2s OFF
^{*2} Measurement at same location as "Initial breakdown voltage" section.
^{*3} Detection current: 10mA
^{*4} Excluding contact bounce time.
^{*5} Half-wave pulse of sine wave: 11 ms; detection time: 10 μs
^{*6} Half-wave pulse of sine wave: 6 ms
^{*7} Detection time: 10 μs
^{*8} Time of vibration for each direction;
 X, Y, Z direction: 4 hours

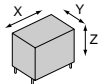
*⁹ Refer to 5. Usage, transport and storage condition mentioned in NOTES*¹⁰ Ambient temperature 125°C 257°F type is also available. Please contact us for details.**Characteristics**

Max. operating speed (at nominal switching capacity)		15cpm
Initial insulation resistance * ²		Min. 20MΩ (at 500 V DC)
Initial breakdown voltage * ³	Between open contacts	500 Vrms for 1min.
	Between contacts and coil	500 Vrms for 1min.
Operate time * ⁴ (at nominal voltage) (at 20°C 68°F)		Max. 10ms
Release time (without diode) * ⁴ (at nominal voltage) (at 20°C 68°F)		Max. 10ms
Shock resistance	Functional * ⁵	Min. 100 m/s ² {10 G}
	Destructive * ⁶	Min. 1,000 m/s ² {100 G}
Vibration resistance	Functional * ⁷	10 to 100 Hz, Min.44.1 m/s ² {4.5 G}
	Destructive * ⁸	10 to 500 Hz, Min.44.1 m/s ² {4.5 G}
Conditions in case of operation, transport and storage * ⁹ (Not freezing and condensing at low temperature)	Ambient temp* ¹⁰	-40 to +85°C -40 to +185°F
	Humidity	25 to 85% R.H.
Unit weight		Approx. 15.0g .53 oz

TYPICAL APPLICATIONS**Automotive system**

Condenser fan, Wiper, Defogger, Magnet clutch, Radiator fan, Foglamp, Auto cruise control, Horn, Heater, Air Compressor

Smart Solutions by NAISSUNSTAR自动化 <http://www.sensor-ic.com/> TEL: 0755-83376489 FAX:0755-83376182 E-MAIL: szss20@163.com

ORDERING INFORMATION

Ex. A CV 1 2 0 12

Product name	Contact arrangement	Mounting classification	Type classification	Coil voltage, V DC
CV	1: 1 Form C 3: 1 Form A	1: Micro ISO plug-in type 2: Micro 280 plug-in type 3: Micro 280 PC board type	0: Standard type 1: With diode inside 2: With resistor inside	12: 12

Note: Standard packing; Carton (Tube): 50 pcs.; Case: 200 pcs.

TYPES

1. Micro ISO terminal type

Coil voltage (DC)	Contact arrangement	Mounting classification	Type classification	Part No.
12 V	1 Form A	Plug-in terminal	Standard type	ACV31012
			With diode inside type	ACV31112
			With resistor inside type	ACV31212
	1 Form C		Standard type	ACV11012
			With diode inside type	ACV11112
			With resistor inside type	ACV11212

2. Micro 280 terminal type

Coil voltage (DC)	Contact arrangement	Mounting classification	Type classification	Part No.
12 V	1 Form A	Plug-in terminal	Standard type	ACV32012
			With diode inside type	ACV32112
			With resistor inside type	ACV32212
		PC board terminal	Standard type	ACV33012
			With diode inside type	ACV33112
			With resistor inside type	ACV33212
	1 Form C	Plug-in terminal	Standard type	ACV12012
			With diode inside type	ACV12112
			With resistor inside type	ACV12212
		PC board terminal	Standard type	ACV13012
			With diode inside type	ACV13112
			With resistor inside type	ACV13212

COIL DATA (at 20°C 68°F)

Nominal voltage, V DC	Pick-up voltage, * V DC (max.)	Drop-out voltage, V DC (min.)	Coil resistance, Ω(±10%)	Nominal operating current, mA (±10%)	Nominal operating power, W	Usable voltage range, V DC
12	(Initial) 7.0	(Initial) 0.6	180 142.3 (with resistor)	67 100 (with resistor)	0.8 1.0 (with resistor)	10 to 16

* Other pick-up voltage types are also available. Please contact us for details.

DIMENSIONS

mm inch

1. Micro ISO terminal type

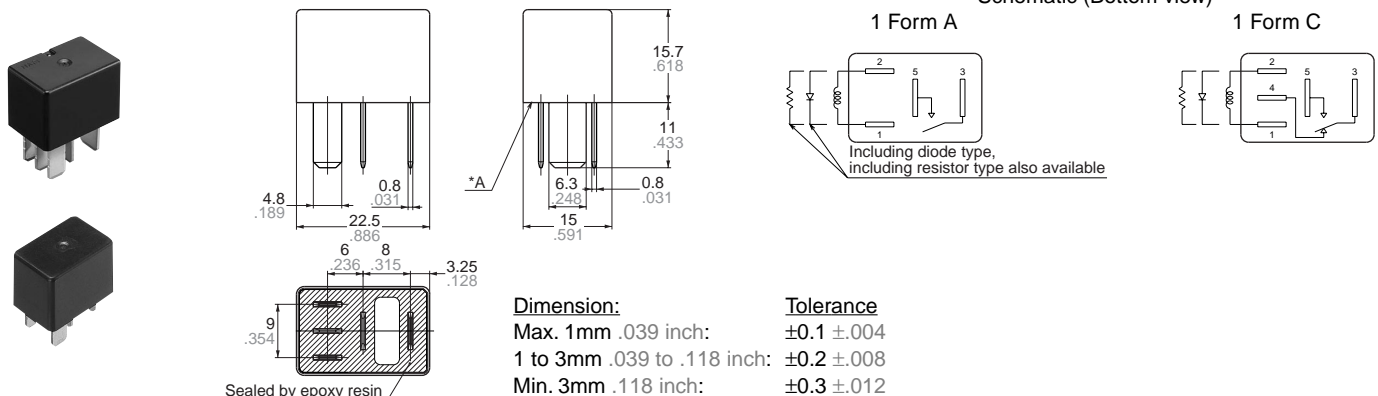

* Dimensions (thickness and width) of terminal specified in this catalog is measured before pre-soldering. Intervals between terminals is measured at A surface level.

2. Micro 280 terminal type

1). Plug-in type

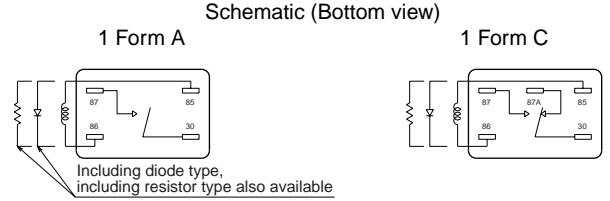
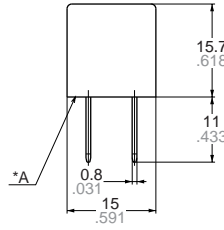
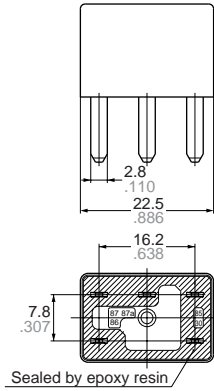
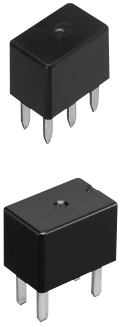

Dimension:	Tolerance
Max. 1mm .039 inch:	±0.1 ±.004
1 to 3mm .039 to .118 inch:	±0.2 ±.008
Min. 3mm .118 inch:	±0.3 ±.012

* Dimensions (thickness and width) of terminal specified in this catalog is measured before pre-soldering. Intervals between terminals is measured at A surface level.

2). PC board type

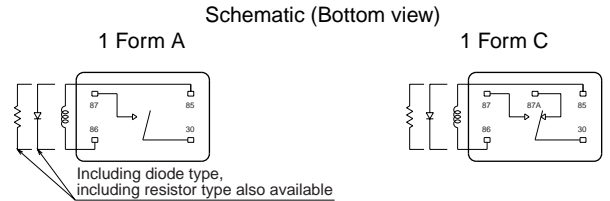
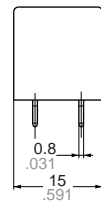
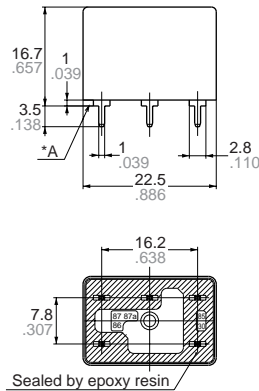

Dimension:	Tolerance
Max. 1mm .039 inch:	±0.1 ±.004
1 to 3mm .039 to .118 inch:	±0.2 ±.008
Min. 3mm .118 inch:	±0.3 ±.012

* Dimensions (thickness and width) of terminal specified in this catalog is measured before pre-soldering. Intervals between terminals is measured at A surface level.

REFERENCE DATA

1. Coil temperature rise

Point measured: Inside the coil
Contact carrying current: 20A
Coil applied voltage: 13.5V

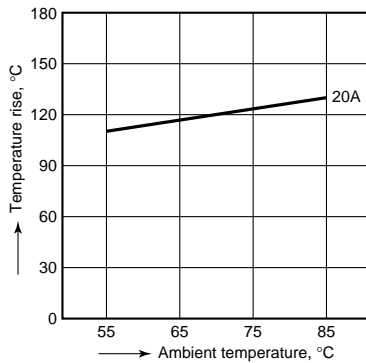

2-(1). Electrical life test (Motor load)

Tested sample: ACV11212
Quantity: n = 3
Load: Inrush 30A, Steady 14A, 13.5V DC
Ambient temperature: Room temperature
Operating frequency: ON 12s, OFF 14s

Circuit:

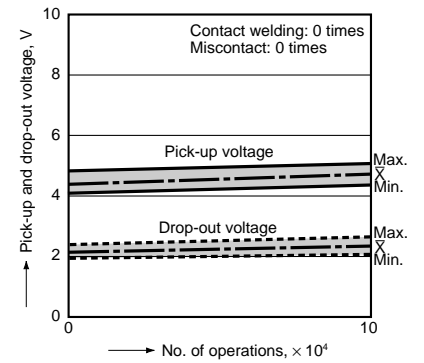
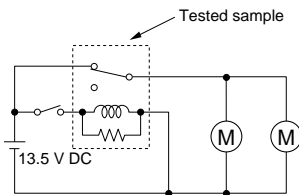

2-(2). Electrical life (Motor load)

Tested sample: ACV31212
Quantity: n = 3
Load: Inrush 65A, Steady 14A, 14V DC
Operating frequency: ON 2s, OFF 6s
Ambient temperature: Room temperature

Circuit:

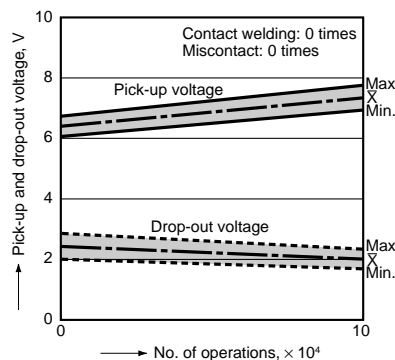
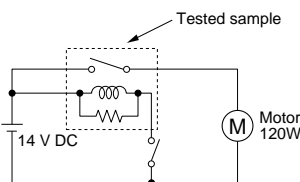

2-(3). Electrical life (Lamp load)

Tested sample: ACV31212

Quantity: n = 5

Load: 120W, Inrush 80A, Steady 10A, 14V DC

Operating frequency: ON 2s, OFF 13s

Ambient temperature: Room temperature

Circuit:

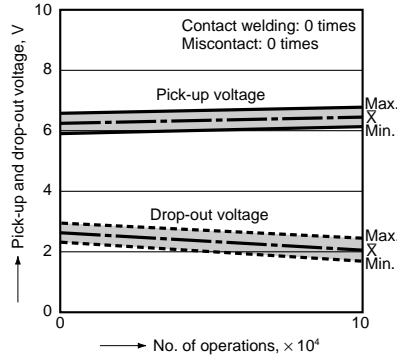
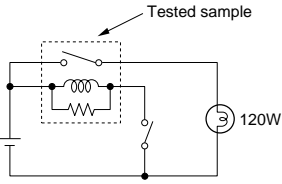
**NOTES****1. Coil operating power**

Pure DC current should be applied to the coil. The wave form should be rectangular. If it includes ripple, the ripple factor should be less than 5%. However, check it with the actual circuit since the characteristics may be slightly different.

2. Voltage applied to coil

To ensure reliable operation, please apply nominal voltage to the coil. Beware of the fact that pick-up voltage and drop-out voltage vary depending on the ambient temperature and conditions.

3. Operating life

Operating life varies depending on the type and load of the coil drive circuit, as well as factors like the operating frequency, operating phase and ambient atmosphere, so please check with actual equipment.

4. Soldering

We recommend the following soldering conditions.

1) Automatic soldering

* Preheating: 100°C 212°F, within 2 mins (PC board solder surface)

* Soldering: 260°C 500°F, within 5 s

2) Hand soldering

* Iron tip temperature: 280 to 300°C 536 to 571°F

* Soldering iron: 30 to 60W

* Soldering time: Within 5 s

5. Usage, transport and storage conditions

1) Ambient temperature, humidity, and atmospheric pressure during usage, transport, and storage of the relay:

(1) Temperature:

-40 to +85°C -40 to +185°F

(2) Humidity: 5 to 85% RH

(Avoid freezing and condensation.)

The humidity range varies with the temperature. Use within the range indicated in the graph below.

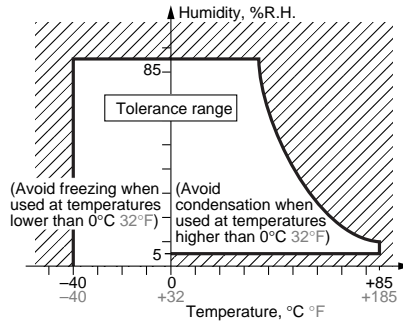

(3) Atmospheric pressure: 86 to 106 kPa

2) Condensation

Condensation forms when there is a sudden change in temperature under high temperature and high humidity conditions. Condensation will cause deterioration of the relay insulation.

3) Freezing

Condensation or other moisture may freeze on the relay when the temperatures are lower than 0°C 32°F. This causes problems such as sticking of movable parts or operational time lags.

4) Low temperature, low humidity environments

The plastic becomes brittle if the relay is exposed to a low temperature, low humidity environment for long periods of time.

6. Others

1) If in error the relay has been dropped, the appearance and characteristics should be checked before use without fail.
2) Please do not use the coating material of organic system which contains solvents such as xylene and toluene for this product.