

Solid State Relay

G3R-I/O

Compact SSRs for I/O Interface with High Dielectric Strength Requirements

- High-speed models with optimum input ratings for a variety of sensors are available
- Input Modules and Output Modules that have the same footprint as the G2R
- Using a coupler approved by VDE 0884 and assuring an I/O dielectric strength of 4 kV
- Incorporating an easy-to-see monitoring indicator
- Approved by UL, CSA, and TÜV
- Can be used with P2RF-05E socket for use on 35 mm DIN track



Ordering Information

To Order: Select the part number and add the desired coil voltage rating, (e.g., G3R-IAZR1SN-DC5)

INPUT MODULE

Isolation	Indicator	Response speed	Logic level		Rated input voltage	Part number
			Supply voltage	Supply current		
Photocoupler	Yes	---	4 to 32 VDC	0.1 to 100 mA	100 to 240 VAC	G3R-IAZR1SN
		High-speed (1 kHz)			5 VDC	G3R-IDZR1SN
		Low-speed (10 Hz)			12 to 24 VDC	
					5 VDC	G3R-IDZR1SN-1
					12 to 24 VDC	

OUTPUT MODULE

Isolation	Indicator	Zero cross function	Applicable output load	Rated input	Part number
Phototriac	Yes	Yes	2 A at 75 to 264 VAC	5 to 24 VDC	G3R-OA202SZN
		No			G3R-OA202SLN
Photocoupler		---	2 A at 4 to 60 VDC		G3R-ODX02SN
			1.5 A at 40 to 200 VDC		G3R-OD201SN

Note: When ordering a TÜV approved model, add "-UTU" to the model number as shown below:
Example: G3R-OA202SZN-UTU.

■ I/O INDICATION

I/O module classification and AC/DC use are indicated on the mark affixed to the top of the product.

Mark indication	Specification
AC IN	Input module, AC input
DC IN	Input module, DC input
AC OUT	Output module, AC output
DC OUT	Output module, DC output

Mark attached to the top of the product

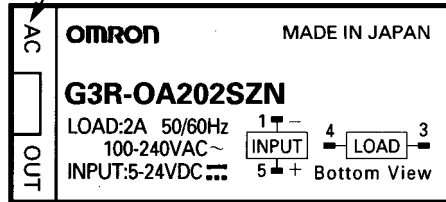

Specifications

■ RATINGS

Input Module

Input

Part number	Rated voltage	Operating voltage	Input current	Must operate voltage	Must release voltage
G3R-IAZR1SN	100 to 240 VAC	60 to 264 VAC	15 mA max.	60 VAC max.	20 VAC min.
G3R-IDZR1SN	5 VDC	4 to 6 VDC	8 mA max.	4 VDC max.	1 VDC min.
	12 to 24 VDC	6.6 to 32 VDC		6.6 VDC max.	3.6 VDC min.
G3R-IDZR1SN-1	5 VDC	4 to 6 VDC		4 VDC max.	1 VDC min.
	12 to 24 VDC	6.6 to 32 VDC		6.6 VDC max.	3.6 VDC min.

Output

Part number	Logic level supply voltage	Logic level supply current
G3R-IAZR1SN	4 to 32 VDC	0.1 to 100 mA
G3R-IDZR1SN		
G3R-IDZR1SN-1		

■ OUTPUT MODULE

Input

Part number	Rated voltage	Operating voltage	Input current	Must operate voltage	Must release voltage
G3R-OA202SZN	5 to 24 VDC	4 to 32 VDC	15 mA max. (at 25°C)	4 VDC max.	1 VDC min.
G3R-OA202SLN			8 mA max.		
G3R-ODX02SN					
G3R-OD201SN					

Output

Part number	Load voltage	Load current (See Note)	Inrush current
G3R-OA202SZN	75 to 264 VAC	0.05 to 2 A	30 A (60 Hz, 1 cycle)
G3R-OA202SLN			
G3R-ODX02SN	4 to 60 VDC	0.01 to 2 A	8 A (10 ms)
G3R-OD201SN	40 to 200 VDC	0.01 to 1.5 A	8 A (10 ms)

Note: The minimum current value is measured at 10°C min.

Characteristics

■ INPUT MODULE

Item	G3R-IAZR1SN	G3R-IDZR1SN	G3R-IDZR1SN-1
Operate time	20 ms max.	0.1 ms max.	15 ms max.
Release time	20 ms max.	0.1 ms max.	15 ms max.
Response frequency	10 Hz	1 kHz	10 Hz
Output ON voltage drop	1.6 V max.		
Leakage current	5 μ A max.		
Insulation resistance	100 M Ω min. between input and output		
Dielectric strength	4,000 VAC, 50/60 Hz for 1 min between input and output		
Vibration resistance	10 to 55 Hz, 1.5-mm double amplitude		
Shock resistance	1,000 m/s ² (approx. 100G)		
Ambient temperature	Operating: -30°C to 80°C (with no icing) Storage: -30°C to 100°C (with no icing)		
Approved standards	UL508 File No. E64562 CSA C22.2 (No. 14, No. 950) File No. LR35535 TÜV File No. R9650094 (EN60950)		
Ambient humidity	Operating: 45% to 85%		
Weight	Approx. 18 g		

OUTPUT MODULE

Item	G3R-OA202SZN	G3R-OA202SLN	G3R-ODX025N	G3R-OA201SN
Operate time	1/2 of load power source cycle + 1 ms max.		1 ms max.	
Release time	1/2 of load power source cycle + 1 ms max.		2 ms max.	
Response frequency	20 Hz		100 kHz	
Output ON voltage drop	1.6 V max.			2.5 V max.
Leakage current	1.5 mA max.		1 mA max.	
Insulation resistance	100 M Ω min. between input and output			
Dielectric strength	4,000 VAC, 50/60 Hz for 1 min between input and output			
Vibration resistance	10 to 55 Hz, 1.5-mm double amplitude			
Shock resistance	1,000 m/s ² {approx. 100G}			
Ambient temperature	Operating: -30°C to 80°C (with no icing) Storage: -30°C to 100°C (with no icing)			
Approved standards	UL508 File No. E64562 CSA C22.2 (No. 14, No. 950) File No. LR35535 TÜV File No. R9650094 (EN60950)			
Ambient humidity	Operating: 45% to 85%			
Weight	Approx. 18 g			

Engineering Data

Load Current vs. Ambient Temperature Characteristics

G3R-OA202SZN/OA202SLN

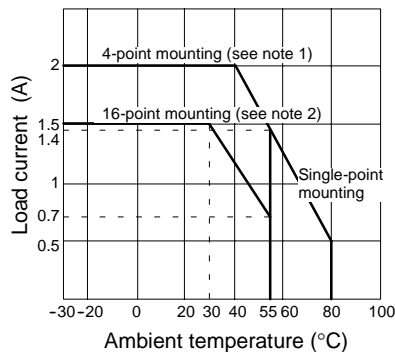

G3R-ODX025N (4 to 60 VDC)

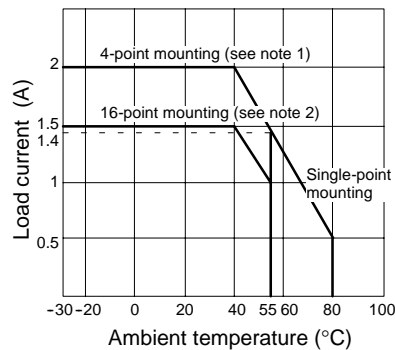

G3R-OD201SN (40 to 200 VAC)

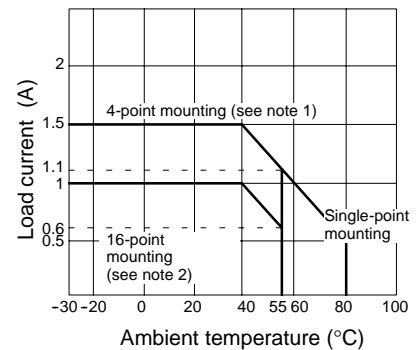

Note: 1. When G730-ZOM04-B is mounted.
2. When G70A-ZOC16 is mounted.

Inrush Current Resistivity

Non-repetitive (Keep the inrush current to half the rated value if it occurs repetitively.)

G3R-OA202SZN/OA202SLN

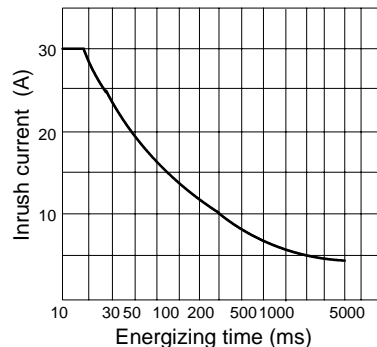

G3R-ODX025N

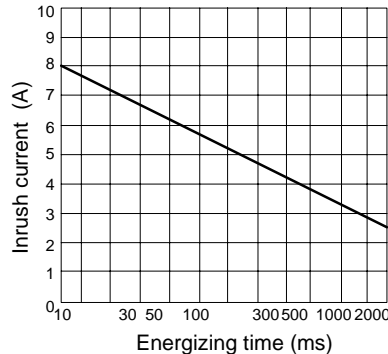

G3R-OD201SN

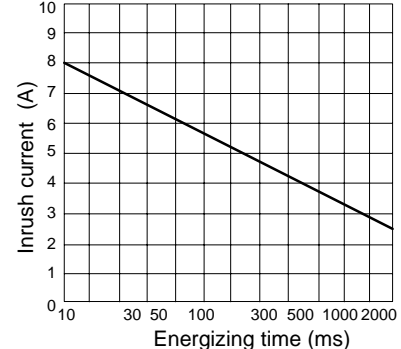

Operation

PRECAUTION OF MOUNTING OUTPUT MODULES

With up to four G3R SSRs mounted closely and side by side, 2-A loads can be switched.

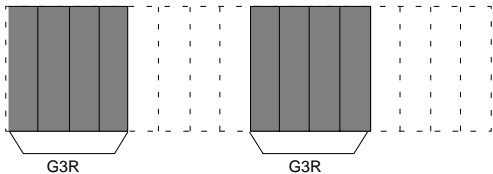

With a G3R SSRs mounted every other slot, 2-A loads can be switched.

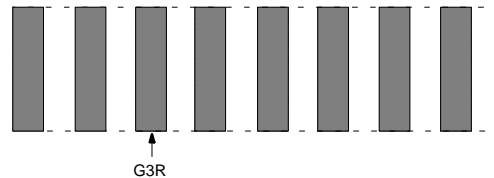

Dimensions

Unit: mm (inch)

G3R

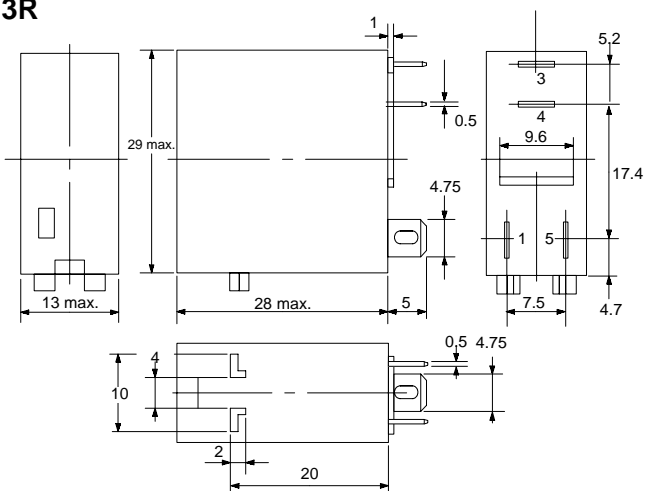

Terminal Arrangement/ Internal Connections (Bottom View)

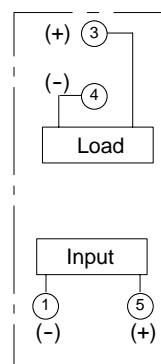

CONNECTING SOCKETS

P2RF-05-E

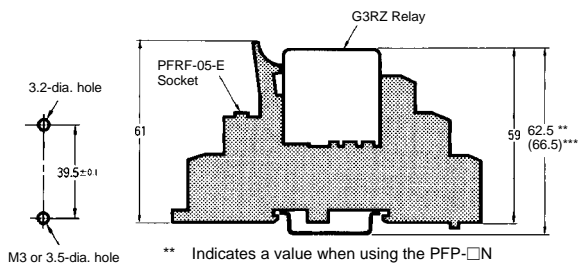
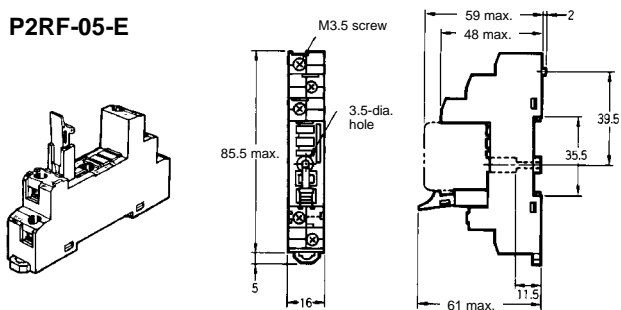

** Indicates a value when using the PFP-□N Supporting Rail with the P2RF-05-E. The value is 71.5 when using the PFP-□N2.

*** Indicates a value when using the PFP-□N Supporting Rail with the P2RF-08-E. The value is 75.5 when using the PFP-□N2.

P2R-057P

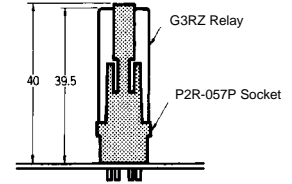
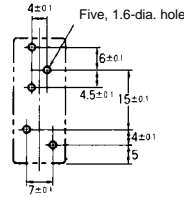
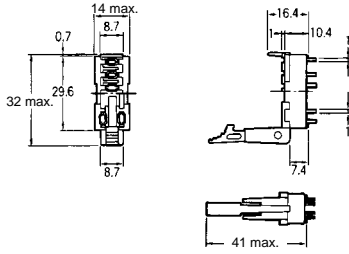
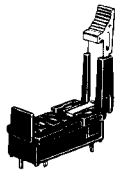

SOCKET MOUNTING PLATE

Use the Socket Mounting Plate when arranging several Sockets in a row.

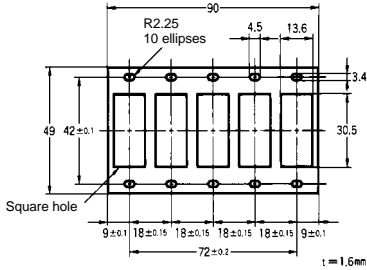

G70A I/O Block Base

ORDERING INFORMATION

Classification	Internal I/O circuit common	Rated voltage	Model
Output	NPN (+ common)	24 VDC	G70A-ZOC16-3
	PNP (- common)	24 VDC	G70A-ZOC16-4
Input	NPN/PNP	110 VDC max., 240 VAC max. (see note)	G70A-ZIM16-5

Note: Each relay to be mounted must incorporate a coil that has proper specifications within the maximum rated voltage range.

Dimensions

Note: All units are in millimeters unless otherwise indicated.

G70A-ZOC16 (Output)

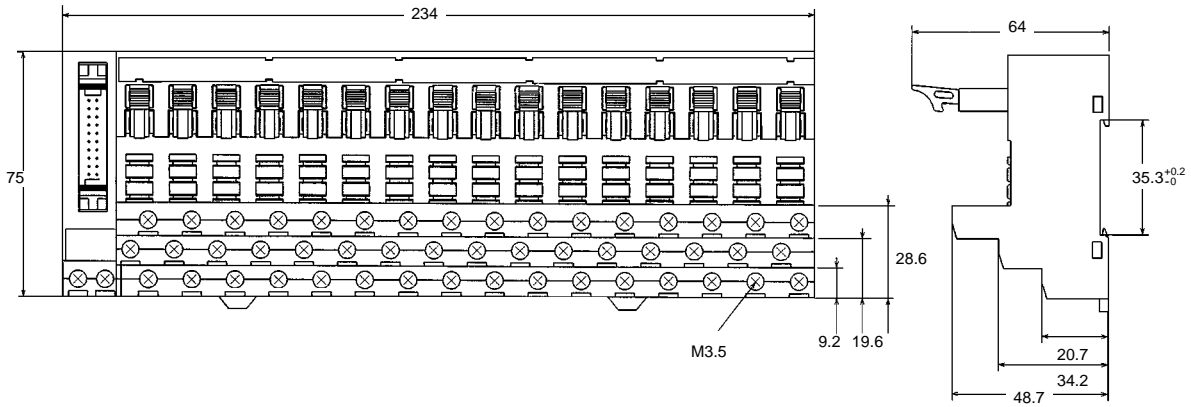

G70A-ZIM16 (Input)

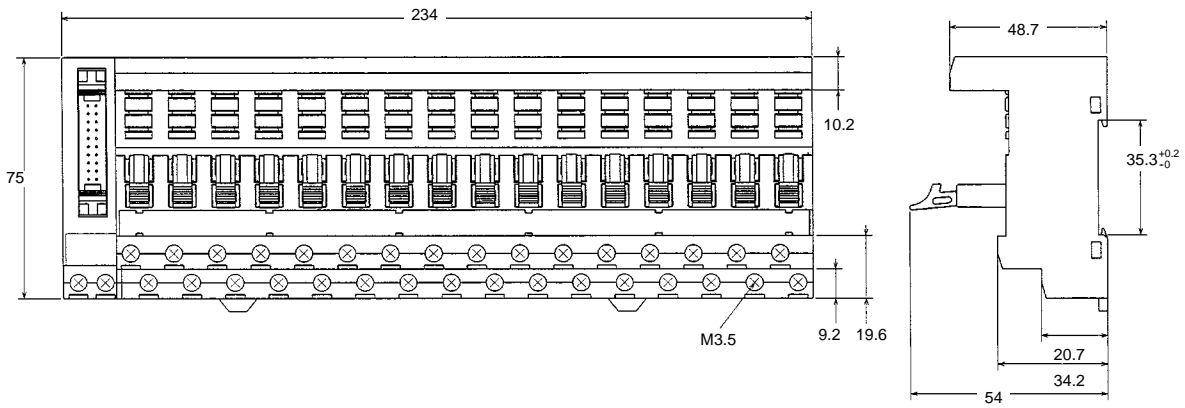

Installation

■ TERMINAL ARRANGEMENT/INTERNAL CONNECTION

G70A-ZOC16-3 (NPN)

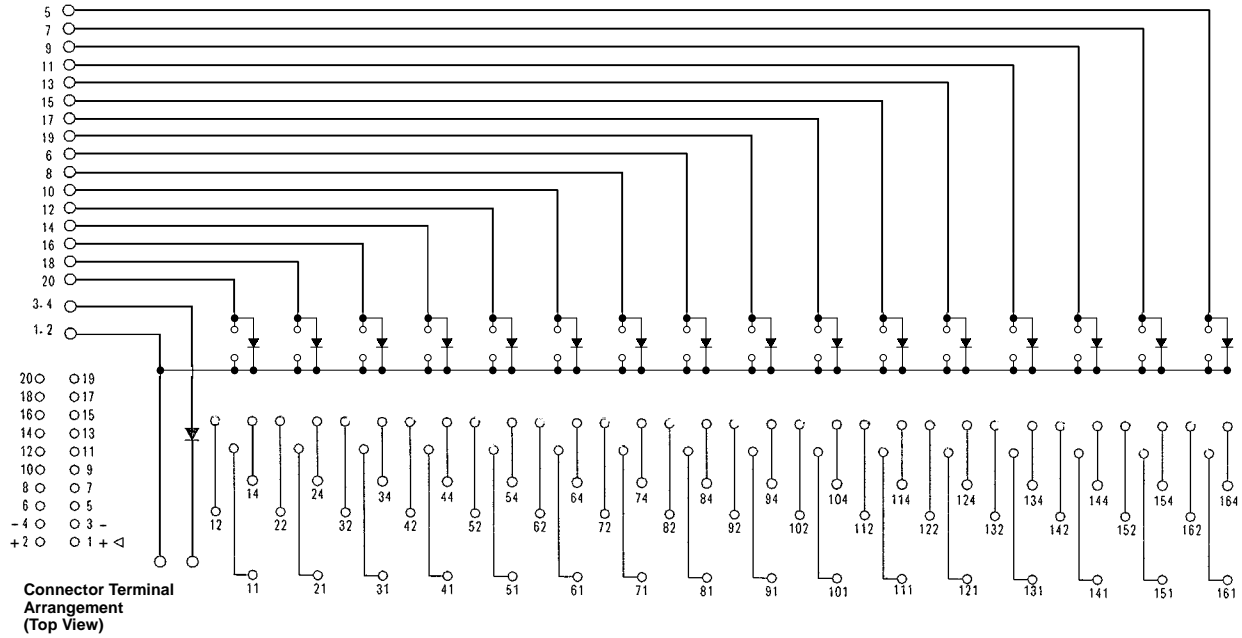

G70A-ZOC16-4 (PNP)

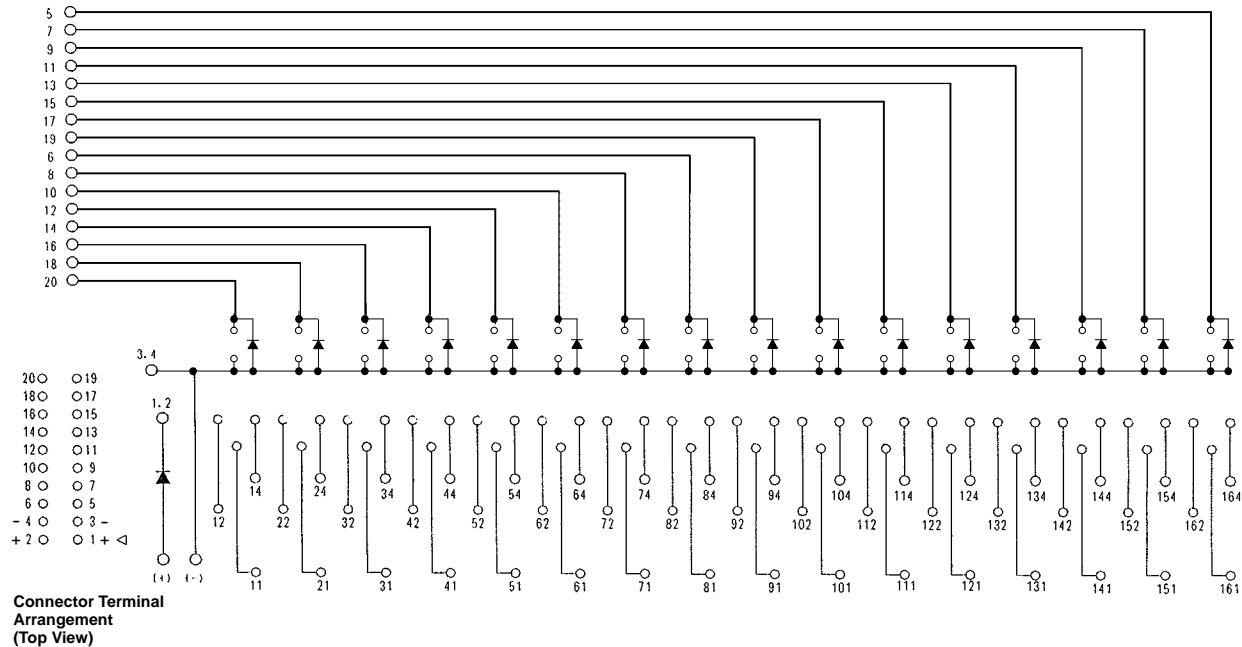

G70A-ZIM16-5 (NPN/PNP)

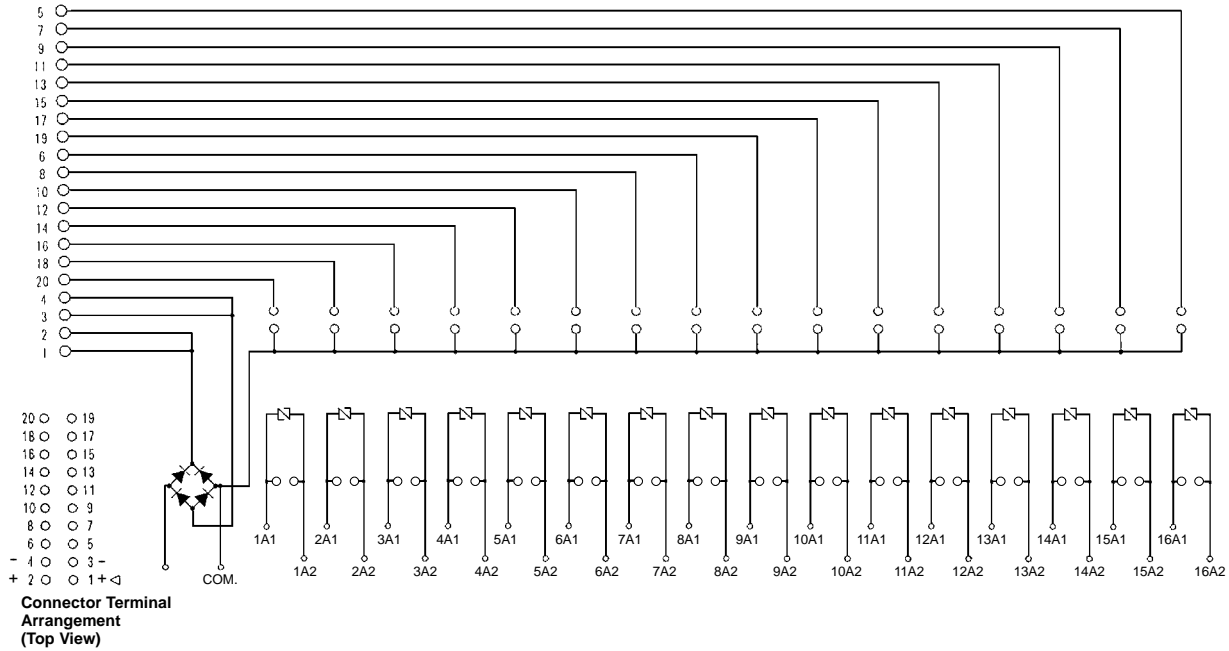

Precautions

Refer to pages NO TAG to NO TAG for general precautions.

■ CONNECTION

With the SSR for DC switching, the load can be connected to either positive or negative output terminal of the SSR.

■ PROTECTIVE ELEMENT

Since the SSR does not incorporate an overvoltage absorption component, be sure to connect an overvoltage absorption component when using the SSR under an inductive load.

NOTE: DIMENSIONS SHOWN ARE IN MILLIMETERS. To convert millimeters to inches divide by 25.4.



OMRON ELECTRONICS, INC.
One East Commerce Drive
Schaumburg, IL 60173
1-800-55-OMRON

OMRON CANADA, INC.
885 Milner Avenue
Scarborough, Ontario M1B 5V8
416-286-6465