

General-purpose Relay

MY

Versatile, Multi-featured, Two-and Four-Pole Miniature Power Relays for Sequence Control and Power Switching Applications

- Increased reliability through automated production
- Multiple features available, including LED indicator, test button, bifurcated contacts, built-in diode and CR (surge suppression)
- Max. switching current: two-pole/10 A, four-pole/5 A
- Environment-friendly cadmium-free contacts
- Built-in operation indicator and name-plate is standard



Ordering Information

■ RELAYS

Standard Coil Polarity

Type	Contact form	Part number		
		Plug-in socket/Solder terminals		
		Standard with LED indicator	With LED indicator and test button	Without LED indicator
Standard	DPDT	MY2N	MY2IN	MY2
	4PDT	MY4N	MY4IN	MY4
	4PDT (bifurcated)	MY4ZN	MY4ZIN	MY4Z
With built-in diode (DC only)	DPDT	MY2N-D2	MY2IN-D2	---
	4PDT	MY4N-D2	MY4IN-D2	---
	4PDT (bifurcated)	MY4ZN-D2	MY4ZIN-D2	---
With built-in CR (220/240 VAC, 110/120 VAC only)	DPDT	MY2N-CR	MY2IN-CR	---
	4PDT	MY4N-CR	MY4IN-CR	---
	4PDT (bifurcated)	MY4ZN-CR	MY4ZIN-CR	---

Note: 1. When ordering, add the rated coil voltage to the model number. Rated coil voltages are given in the coil ratings table.

Example: MY2 AC6(S)

↑
Rated coil voltage

2. Arc barrier standard on all four-pole relays.
3. Other models also available, such as, three-pole versions, flangemount, PCB, etc. Contact your Omron Representative for details.

Ordering Information - continued from previous page

Reverse Coil Polarity

Type	Contact form	Part number	
		Plug-in socket/Solder terminals	
		With LED indicator	With LED indicator and test button
Standard (DC only)	DPDT	MY2N1	MY2IN1
	4PDT	MY4N1	MY4IN1
	4PDT (bifurcated)	MY4ZN1	MY4ZIN1
With built-in diode (DC only)	DPDT	MY2N1-D2	MY2IN1-D2
	4PDT	MY4N1-D2	MY4IN1-D2
	4PDT (bifurcated)	MY4ZN1-D2	MY4ZIN1-D2

Note: 1. When ordering, add the rated coil voltage to the model number. Rated coil voltages are given in the coil ratings table.

Example: MY2 AC6(S)



Rated coil voltage

2. Arc barrier standard on all four-pole relays.

Specifications

COIL RATINGS

Rated voltage	Rated current		Coil resistance	Inductance (reference value)		Must operate	Must release	Max. voltage	Power consumption (approx.)	
	50 Hz	60 Hz		Arm. OFF	Arm. ON					
AC	6 V*	214.1 mA	183 mA	12.2 Ω	0.04 H	0.08 H	80% max.	30% min.	110%	1.0 to 1.2 VA (60 Hz)
	12 V	106.5 mA	91 mA	46 Ω	0.17 H	0.33 H				
	24 V	53.8 mA	46 mA	180 Ω	0.69 H	1.30 H				
	48 V*	25.7 mA	22 mA	788 Ω	3.22 H	5.66 H				
	110/120 V	9.9/10.8 mA	8.4/9.2 mA	4,430 Ω	19.20 H	32.1 H				
	220/240 V	4.8/5.3 mA	4.2/4.6 mA	18,790 Ω	83.50 H	136.4 H				
DC	6 V*	151 mA		39.8 Ω	0.17 H	0.33 H	10% min.		0.9 W	
	12 V	75 mA		160 Ω	0.73 H	1.37 H				
	24 V	37.7 mA		636 Ω	3.20 H	5.72 H				
	48 V*	18.8 mA		2,560 Ω	10.60 H	21.0 H				
	100/110 V	9.0/9.9 mA		11,100 Ω	45.60 H	86.2 H				

Note: 1. The rated current and coil resistance are measured at a coil temperature of 23°C with tolerances of +15%/-20% for rated currents and ±15% for DC coil resistance.

2. Performance characteristic data are measured at a coil temperature of 23°C.

3. AC coil resistance and impedance are provided as reference values (at 60 Hz).

4. Power consumption drop was measured for the above data. When driving transistors, check leakage current and connect a bleeder resistor if required.

5. Rated voltage denoted by "*" will be manufactured upon request. Ask your OMRON representative.

■ CONTACT RATINGS

Item	2-pole		4-pole		4-pole (bifurcated)	
	Resistive load ($\cos\phi = 1$)	Inductive load ($\cos\phi = 0.4$, L/R = 7 ms)	Resistive load ($\cos\phi = 1$)	Inductive load ($\cos\phi = 0.4$, L/R = 7 ms)	Resistive load ($\cos\phi = 1$)	Inductive load ($\cos\phi = 0.4$, L/R = 7 ms)
Rated load	5A, 250 VAC 5A, 30 VDC	2A, 250 VAC 2 A, 30 VDC	3 A, 250 VAC 3 A, 30 VDC	0.8 A, 250 VAC 1.5 A, 30 VDC	3 A, 250 VAC 3 A, 30 VDC	0.8 A, 250 VAC 1.5 A, 30 VDC
Carry current	10 A (See Note.)		5 A (See Note.)			
Max. switching voltage	250 VAC 125 VDC		250 VAC 125 VDC			
Max. switching current	10 A		5 A			
Max. switching capacity	2,500 VA 300 W	1,250 VA 300 W	1,250 VA 150 W	500 VA 150 W	1,250 VA 150 W	500 VA 150 W

Note: Do not exceed the carry current of a Socket in use.

■ CHARACTERISTICS

Contact resistance	100 mΩ max.	
Operate time	20 ms max.	
Release time	20 ms max.	
Max. operating frequency	Mechanical	18,000 operations/hr
	Electrical	1,800 operations/hr (under rated load)
Insulation resistance	1,000 MΩ min. (at 500 VDC)	
Dielectric withstand voltage	2,000 VAC, 50/60 Hz for 1.0 min (1,000 VAC between contacts of same polarity)	
Vibration resistance	Destruction: 10 to 55 Hz, 1.0 mm double amplitude Malfunction: 10 to 55 Hz, 1.0 mm double amplitude	
Shock resistance	Destruction: 1,000 m/s ² (approx. 100G) Malfunction: 200 m/s ² (approx. 20G)	
Life expectancy	See the following table.	
Ambient temperature	Operating	-55°C to 70°C (-67°F to 158°F) with no icing (See Note.)
Ambient humidity	Operating	35% to 85%
Weight	Approx. 35 g	

Note: The values given above are initial values.

■ LIFE EXPECTANCY CHARACTERISTICS

Pole	Mechanical life (at 18,000 operations/hr)	Electrical life (at 1,800 operations/hr under rated load)
2-pole	AC: 50,000,000 operations min. DC: 100,000,000 operations min.	500,000 operations min.
4-pole		200,000 operations min.
4-pole (bifurcated)	20,000,000 operations min.	100,000 operations min.

■ APPROVED STANDARDS

VDE, UL, CSA, IMQ, CE

Engineering Data

MAXIMUM SWITCHING CAPACITY

MY2

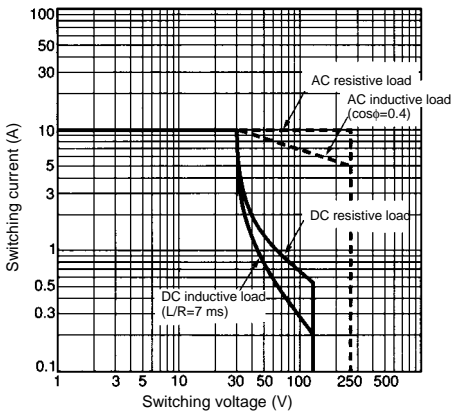

MY4, MY4Z

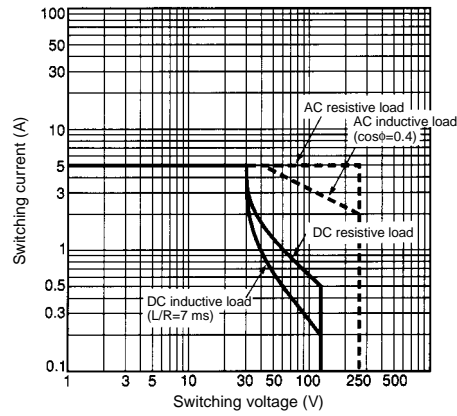

LIFE EXPECTANCY

MY2 (Resistive Loads)

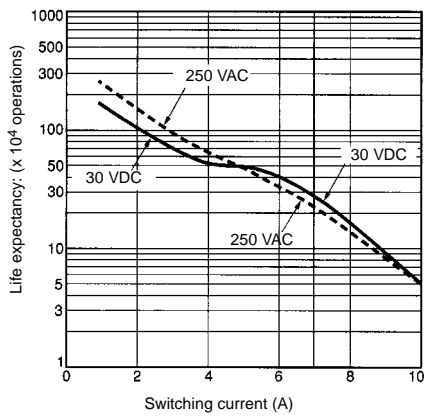

MY2 (Inductive Loads)

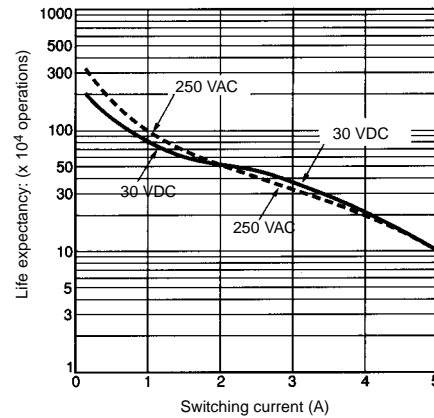

MY4 (Resistive Loads)

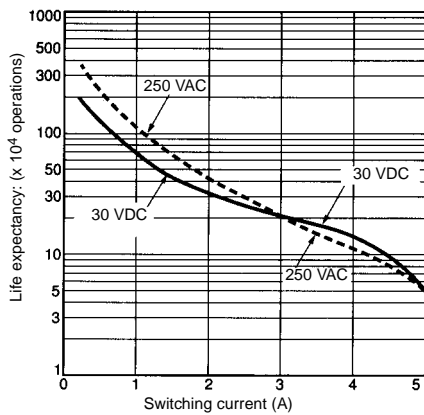

MY4 (Inductive Loads)

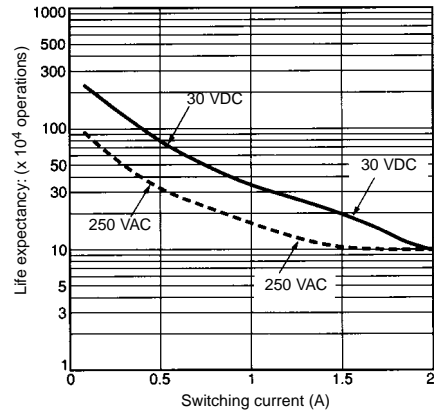

MY4Z (Resistive Loads)

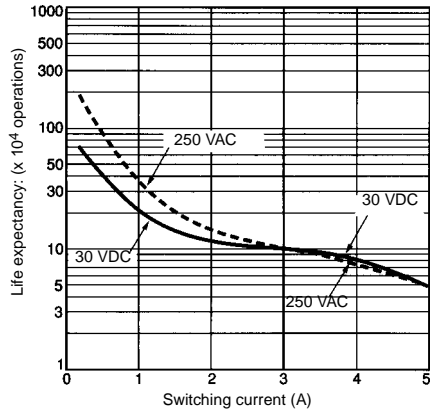

MY4Z (Inductive Loads)

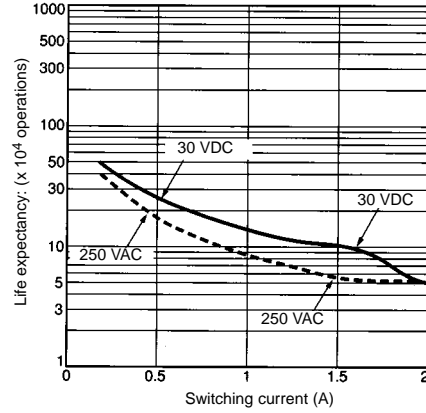

Dimensions

Unit: mm (inch)

2-POLE MODELS

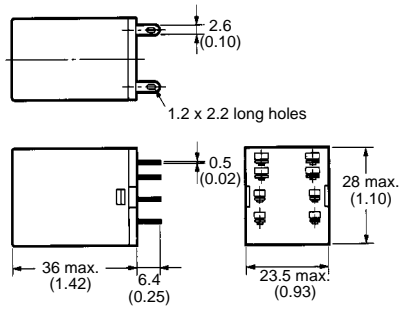
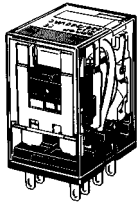

4-POLE MODELS

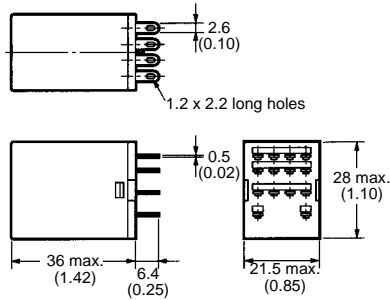
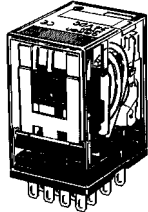

MODELS WITH TEST BUTTON

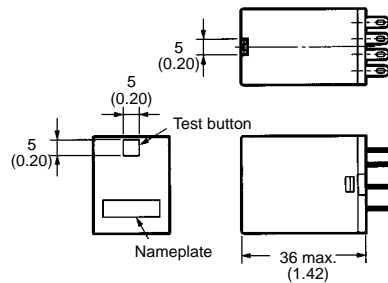
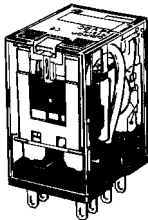

■ TERMINAL ARRANGEMENT/INTERNAL CONNECTIONS (BOTTOM VIEW)

MY2

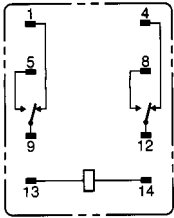

MY2N/MY2IN
(AC Models)

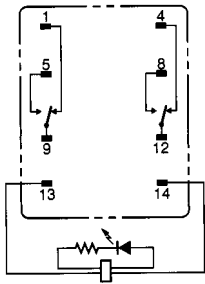

MY2N/MY2IN
(DC Models)

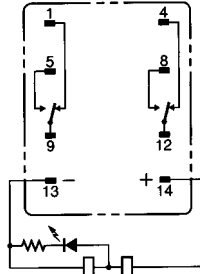

MY2N-D2/MY2IN-D2
(DC Models Only)

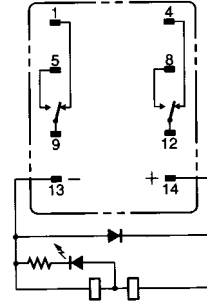

MY2N-CR/MY2IN-CR
(AC Models Only)

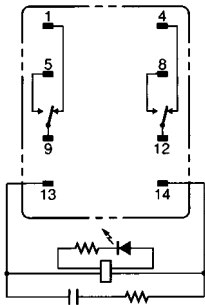

MY2N1/MY2IN1
(DC Models Only)

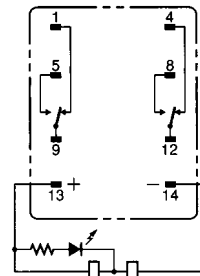

MY2N1-D2/MY2IN1-D2
(DC Models Only)

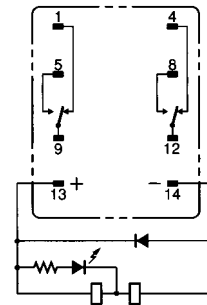

MY4(Z)

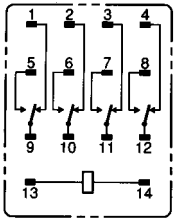

MY4(Z)N/MY4(Z)IN
(AC Models)

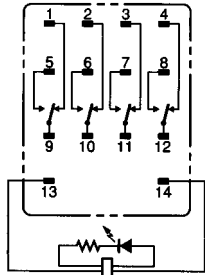

MY4(Z)N/MY4(Z)IN
(DC Models)

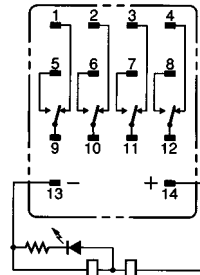

MY4(Z)N-D/MY4(Z)IN-D2
(DC Models Only)

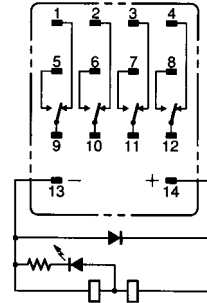

MY4(Z)N-CR/MY4(Z)IN-CR
(AC Models Only)

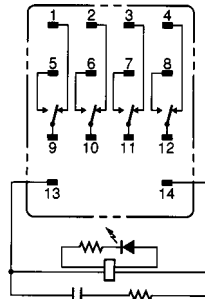

MY4(Z)N1/MY4(Z)IN1
(DC Models Only)

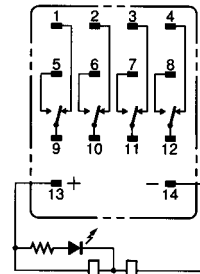

MY4(Z)N1-D2/MY4(Z)IN1-D2
(DC Models Only)

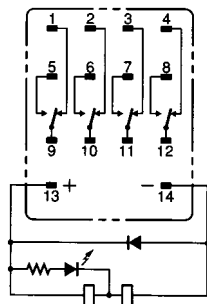

Accessories (order separately)

■ SOCKETS

Poles	Front-mounting Socket (DIN-track/screw mounting)	Back-mounting Socket		
		Solder terminals		PCB terminals
		Without clip	With clip	
2	PYF08A-E	PY08	PY08-Y1	PY08-02
4	PYF14A-E	PY14	PY14-Y1	PY14-02

■ SOCKET HOLD-DOWN CLIP PAIRING

Relay type	Poles	Front-connecting Socket (DIN-track/screw mounting)		Back-connecting Socket			
		Solder terminals		PCB terminals			
		Socket	Clip	Socket	Clip	Socket	Clip
Without 2-pole test button	2	PYF08A-E	PYC-A1	PY08	PYC-P	PY08-02	PYC-P
	4	PYF14A-E		PY14	PYC-P2	PY14-02	PYC-P2
2-pole test button	2	PYF08A-E	PYC-E1	PY08	PYC-P2	PY08-02	PYC-P2

■ MOUNTING PLATES FOR SOCKETS

Socket model	For 1 Socket	For 18 Sockets	For 36 Sockets
PY08, PY14	PYP-1	PYP-18	PYP-36



Note: PYP-18 and PYP-36 can be cut into any desired length in accordance with the number of Sockets.



■ DIN RAIL TRACK AND ACCESSORIES

Description	Part number
Mounting Rail (length = 500 mm)	PFP-50N
Mounting Rail (length = 1,000 mm)	PFP-100N, PFP-100N2
End Plate	PFP-M
Spacer	PFP-S

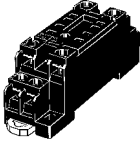
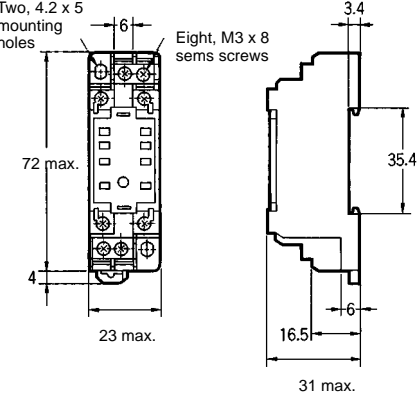
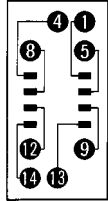
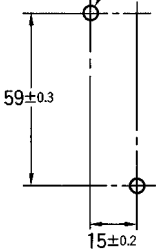
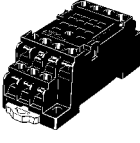
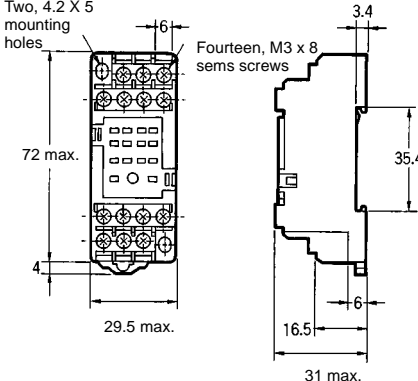
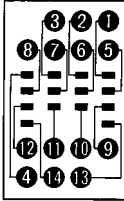
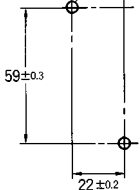
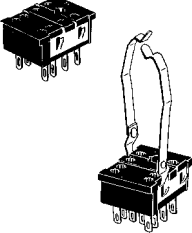
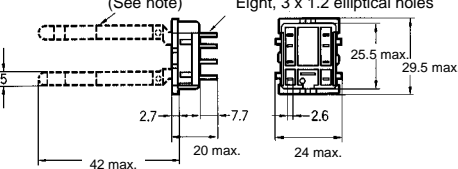
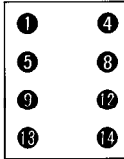
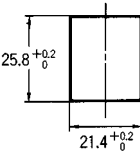
Dimensions

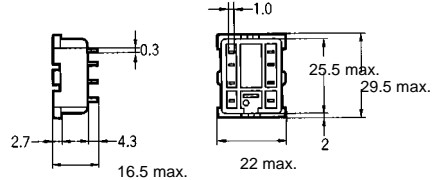
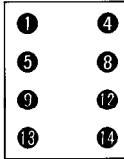
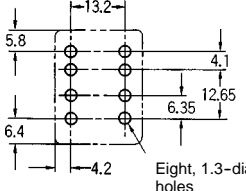
Unit: mm (inch)

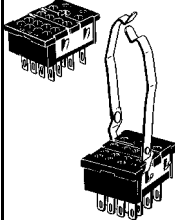
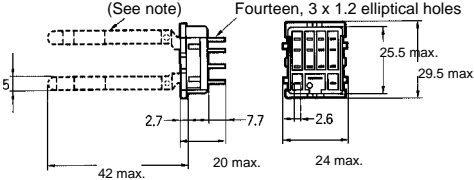
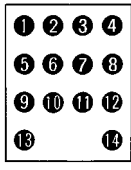
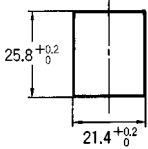
Socket	Dimensions	Terminal arrangement/Internal connections (top view)	Mounting holes
			<p>Two, M3, M4, or 4.5-dia holes</p>  <p>(TOP VIEW)</p> <p>Note: Track mounting is also possible. Refer to page NO TAG for supporting tracks.</p>
			<p>Two, M3, M4, or 4.5-dia holes</p>  <p>(TOP VIEW)</p> <p>Note: Track mounting is also possible. Refer to page NO TAG for supporting tracks.</p>
	<p>(See note)</p>  <p>Note: The PY08-Y1 includes sections indicated by dotted lines.</p>		
			 <p>Eight, 1.3-dia holes</p>

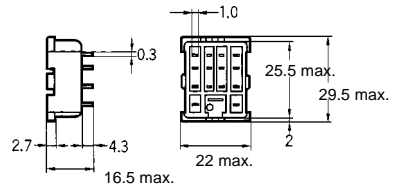
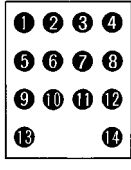
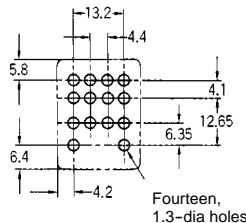
Socket	Dimensions	Terminal arrangement/Internal connections (top view)	Mounting holes
 <p>PY14/PY14-Y1</p>	 <p>(See note) Fourteen, 3 x 1.2 elliptical holes</p> <p>25.5 max. 29.5 max. 42 max. 20 max. 24 max. 2.7 7.7 2.6</p> <p>Note: The PY14-Y1 includes sections indicated by dotted lines.</p>		 <p>25.8^{+0.2}₀ 21.4^{+0.2}₀</p>
 <p>PY14-02</p>	 <p>1.0 0.3 25.5 max. 29.5 max. 2.7 4.3 16.5 max. 22 max. 2</p>		 <p>Fourteen, 1.3-dia holes</p>

Note: Use a panel with plate thickness of 1 to 2 mm for mounting the Sockets.

■ HOLD-DOWN CLIPS

PYC-A1

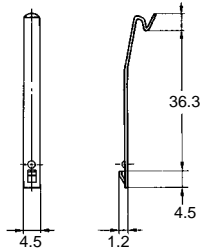

PYC-E1

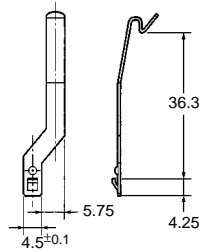

PYC-P

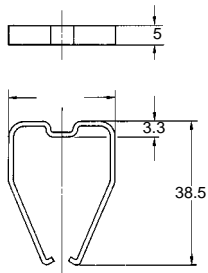

PYC-P2

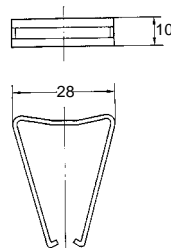

■ MOUNTING PLATES FOR BACK-CONNECTING SOCKETS

PYP-1

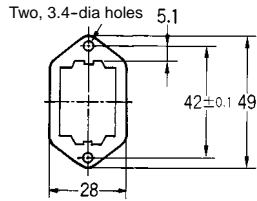

PYP-36

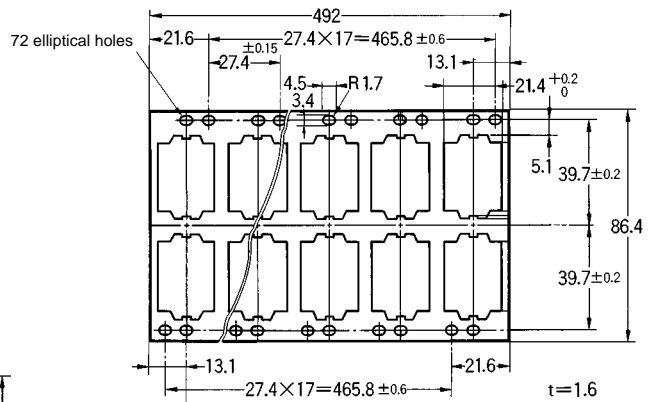

PYP-18

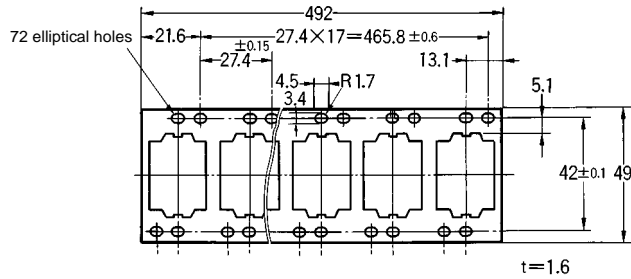

■ MOUNTING TRACK AND ACCESSORIES

Din rail track

PFP-50N/PFP-100N

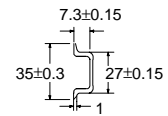
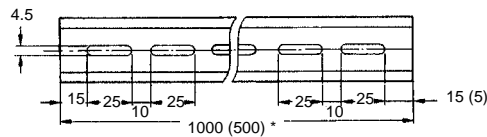
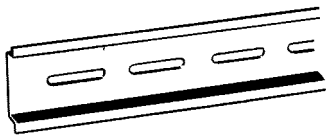

Note: The figure in the parentheses is for PFP-50N.

PFP-100N2

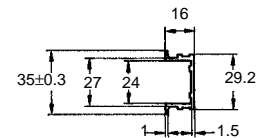
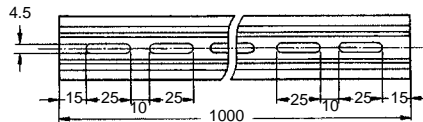
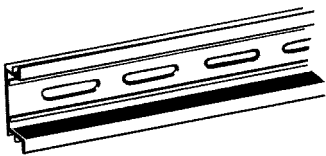

End plate

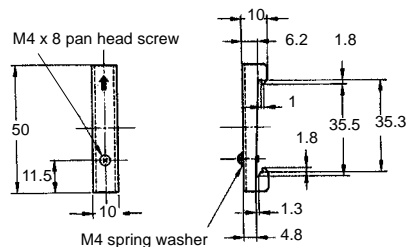
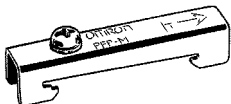

Spacer

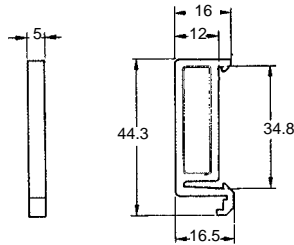
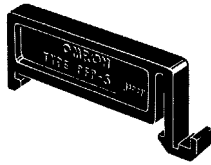

■ APPROVALS

UL recognized type (File no. E41515)

Type	Contact form	Coil ratings	Contact ratings
MY□	DPDT	6 to 240 VAC, 6 to 120 VDC	5 A, 120 VAC (resistive)
			5 A, 28 VDC (resistive)
			5 A, 240 VAC (inductive)
	3PDT		5 A, 28 VDC (resistive)
			5 A, 240 VAC (resistive)
			3 A, 28 VDC (resistive)
	4PDT		3 A, 120 VAC (inductive)
			1.5 A, 240 VAC (inductive)
			5 A, 240 VAC (inductive, same polarity)
MY2K-□	DPDT	5 to 120 VAC, 5 to 48 VDC	5 A, 28 VDC (resistive, same polarity)
			3 A, 240 VAC (resistive)
			3 A, 28 VDC (resistive)

CSA certified type (File no. LR31928)

Type	Contact form	Coil ratings	Contact ratings
MY□	DPDT, 3PDT	6 to 240 VAC, 6 to 120 VDC	5 A, 28 VDC (resistive)
			5 A, 240 VAC (inductive)
	4PDT		3 A, 28 VDC (resistive)
			3 A, 240 VAC (inductive)
			5 A, 240 VAC (inductive, same polarity)
			5 A, 28 VDC (resistive, same polarity)
MY2K-□	DPDT	5 to 120 VAC, 5 to 48 VDC	3 A, 240 VAC (general purpose)
			3 A, 28 VDC (resistive)

LR (Lloyd's register) approved type (File no. 563KOB-204524)

Type	Contact form	Coil ratings	Contact ratings
MY□	DPDT	6 to 240 VAC, 6 to 120 VDC	2 A, 30 VDC (inductive)
			2 A, 200 VAC (inductive)
	4PDT		1.5 A, 30 VDC (inductive)
			0.8 A, 200 VAC (inductive)
			1.5 A, 115 VAC (inductive)

SEV listed type (File no. D791/63 [2 & 4-pole], D791/91 [3-pole])

Type	Contact form	Coil ratings	Contact ratings
MY□-SV	DPDT	6 to 240 VAC, 6 to 110 VDC	5 A, 220 VAC (resistive)
	3PDT		5 A, 24 VDC (resistive)
	4PDT		

- Note: 1. The rated values approved by each of the safety standards (eg., UL, CSA, VDE, and SEV) may be different from the performance characteristics individually defined in this catalog.
 2. In the interest of product improvement, specifications are subject to change.

NOTE: DIMENSIONS SHOWN ARE IN MILLIMETERS. To convert millimeters to inches divide by 25.4.

OMRON®

OMRON ELECTRONICS, INC.

One East Commerce Drive
Schaumburg, IL 60173

1-800-55-OMRON

OMRON CANADA, INC.

885 Milner Avenue
Scarborough, Ontario M1B 5V8

416-286-6465