

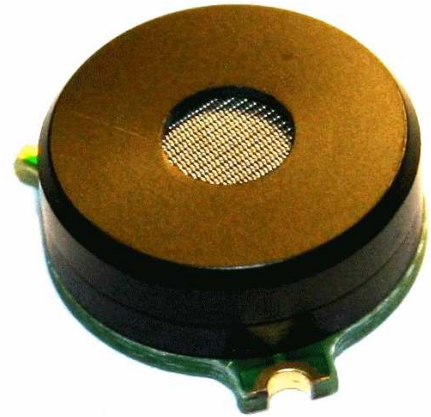

MP-7217 (VQ548MP) Operating Mode

The MP-7217 (VQ548MP) pellistor is a combustible gas sensor commonly used, but not exclusively, in mining applications for the protection of personnel and facilities.



Features

Outstanding performances are linked to innovative structure design.

Passing from a classical platinum coil to micro machined diaphragm (MEMS) with embedded planar heater meander combined with a cycled operating mode allows drastic reduction of power consumption.

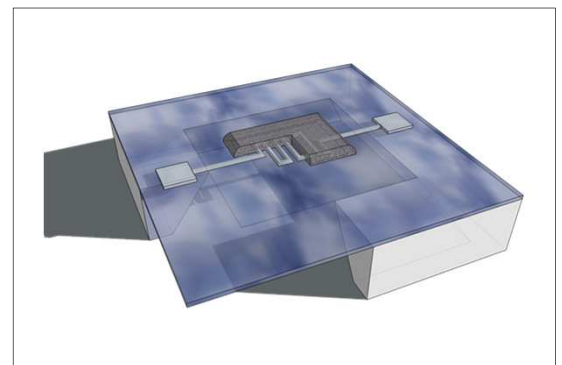
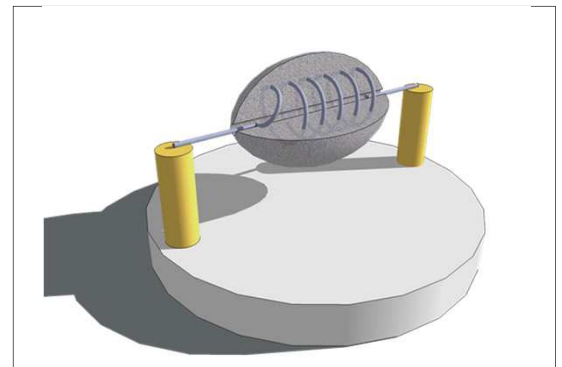

For more information please contact:

sales.is@sgxsensortech.com

SGX Sensortech, 2 Hanbury Road
Chelmsford, Essex CM1 3AE
United Kingdom

www.sgxsensortech.com

Description

The MEMS pellistor structure consists of a pair of planar metal heaters coated with a layer incorporating a noble metal catalyst for Detector structure and with inert layer for Compensator structure.

This heater pair deposited onto membranes, optimally designed for thermal insulation, allows operating power as low as 60 mW per structure (120 mW for the pair) in continuous operation.

The meander acts both as an electrical heater and as a resistance thermometer. The pellistor dual-structure is die attached on a PCB and electrically connected with wire bonding. The sensor chip is surrounded by a plastic can equipped with flame arrestor towards the end open to the atmosphere.

If a flammable gas is present when the sensor is heated to about 400 – 500 °C, the gas will oxidise and the resultant release of energy will heat the sensor heater still further. This increase in temperature is detected as an increase in resistance of the heater meander.

To perform the measurement the dual structure (Comp, Det) is then used in a circuit that detects the difference in their resistances.

Measurement circuit

Pellistor measurements are commonly performed by using a Wheatstone bridge.

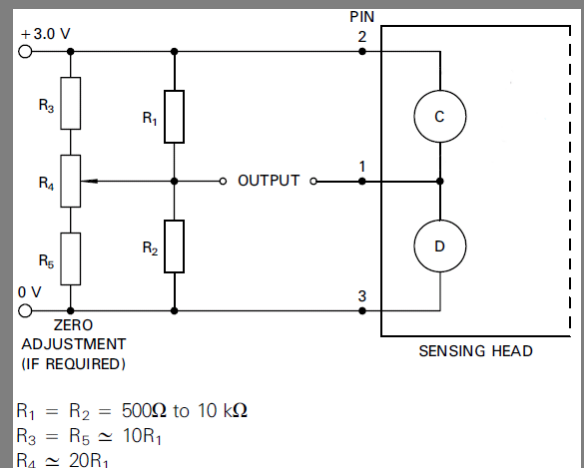

By using a duty cycle operation defined by the ratio of the time when sensor is powered over the cycle period (T_{ON}/T), power consumption can be reduced.

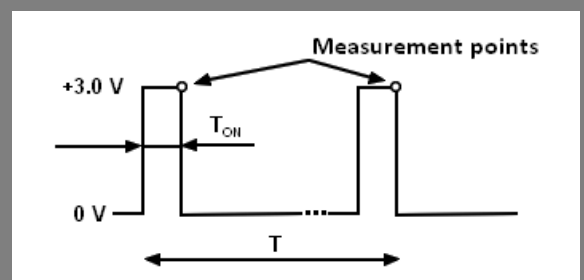

Operation principle

The cycled mode (phase 1) has to be controlled by the CPU used in the instrument in order to synchronize sensor operation with the measurement (phase 2). To allow reliable measurement, the measurements performed at the end of the operation period have to be averaged over several samples according to the acquisition frequency and ADC performances (phase 3). Based on the measurement and the calibration the gas concentration can be calculated and displayed by the instrument.

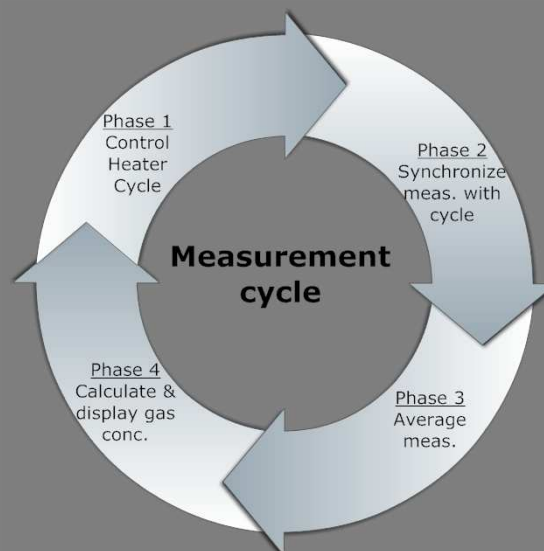

Cycle mode definition

The duty cycle and period length are linked with the application constraints in term of T90%.

The sensor needs less than 30ms to reach the operating temperature. After this point one can observe the catalytic reaction in presence of gas and maximum signal response after around 250ms.

Minimal operating period is then defined by this value. The period of non-operation and therefore the time between two measurements define response time.

In continuous operation T90% is around 12 seconds for methane detection, this value is not changed with cycle mode operation as the main part of the response time is linked with diffusion time through the cap.

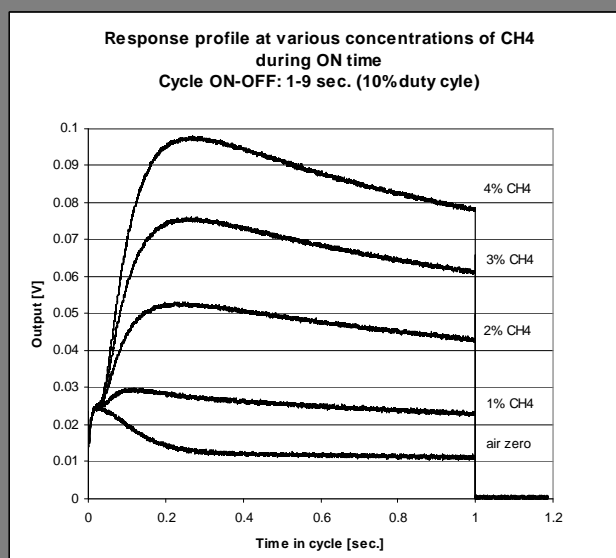

Performances

The value reached after 200 to 1000 ms is higher than the one obtained in continuous mode. Net sensitivity is then higher in cycled mode as shown here beside.

This shows a side effect phenomena caused by the non continuous combustion of the gas reaching the heated catalytic layer.

In continuous operation mode the sensor response is linked with the equilibrium between the gas diffusion through the cap and the catalytic reaction.

In cycled mode a higher sensitivity is obtained by measuring the sensor output before this equilibrium takes place.

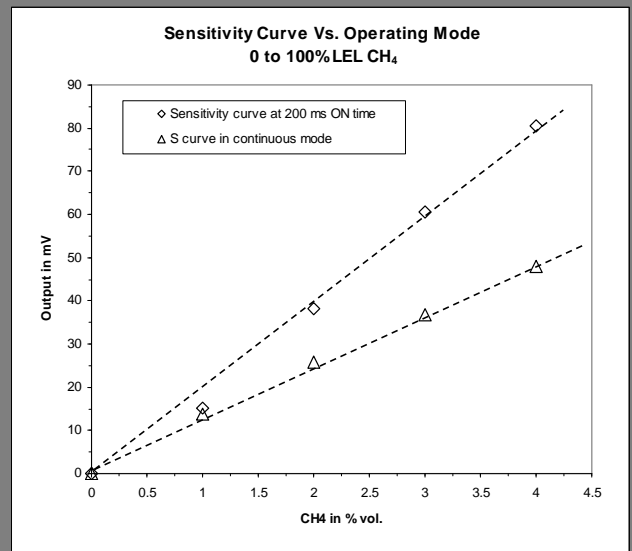

Application

The cycled operation mode feature is Ideal for use in hand held instrument as battery life can be tremendously increase.

Beside is presented an example of battery lifetime increase by using such cycled operation mode.

Battery capacity	1100	mAh
Battery cycle life consideration	80%	
Constant current consumption	40	mAh
Constant current lifetime	22	h
Cycle mode	4%	duty cycle
T_ON	0.2	sec.
T_OFF	4.8	sec.
T (Period)	5	sec.
Average power	4.8	mW
Cycle mode lifetime	550	hours
Cycle mode lifetime	22.9	days
Cycle mode lifetime	3.3	weeks

For more information please contact:

Sales.is@sgxsensortech.com

SGX Sensortech, 2 Hanbury Road
Chelmsford, Essex CM1 3AE
United Kingdom

www.sgxsensortech.com

Whilst SGX Sensortech has taken care to ensure the accuracy of the information contained herein it accepts no responsibility for the consequences of any use thereof and also reserves the right to change the specification of goods without notice. SGX Sensortech accepts no liability beyond the set out in its standard conditions of sale in respect of infringement of third party patents arising from the use of pellistors or other devices in accordance with information contained herein.