



# K10 series

## 15 Amp General Purpose Miniature Relay

File E22575

File LR15734

### Features

- K10 - DPDT contact arrangement standard.
- AC and DC coils.
- Mounting options include socket, PCB, top flange.
- UL Class B coil insulation system.

### Contact Data @ 25°C

**Materials:** Silver-cadmium oxide.

**Expected Life:** 10 million operations, mechanical; 100,000 operations minimum at rated loads.

### Contact Ratings

Contact Code	Material	UL/CSA Ratings	Type
5	Silver-cadmium oxide	15A @ 30VDC 15A @ 120VAC 1/3HP @ 120VAC 1/2HP @ 250VAC	Resistive Resistive

### Initial Dielectric Strength

**Between Open Contacts:** 1,000V rms.

**Between Adjacent Contacts:** 1,500V rms.

**Between Contacts and Coil:** 1,500V rms.

### Coil Data @ 25°C

**Nominal Power:**

**DC Coils:** .9 Watts.

**AC Coils:** 1.2VA.

**Maximum Power:** 2.0 Watts.

**Duty Cycle:** Continuous.

**Insulation: Class B:** (130°C).

### Coil Data

Nominal Voltage	DC Coils		AC Coils	
	Resistance in Ohms ± 10%	Nominal Current in Milliamps	Resistance in Ohms ± 15%	Nominal Current in Milliamps
6	40	150	10.5	200
12	160	75	43	100
24	650	37	160	52
48	2,600	18.5	668	26
110	11,000	10	—	—
120*	—	—	3,900	11
240*	—	—	12,000	6

\*For 220/240VDC operation, use 11,000 Ohm, 5 Watt dropping resistor in series with the 110VDC coil.

### Operate Data @ 25°C

**Must Operate Voltage:**

**DC Coils:** 75% of nominal voltage.

**AC Coils:** 85% of nominal voltage.

**Operate Time (Excluding Bounce):** 13 milliseconds, typical, at nominal voltage.

**Release Time (Excluding Bounce):** 6 milliseconds, typical, at nominal voltage.

### Environmental Data

**Temperature Range:**

**Storage:** -60°C to +105°C.

**Operating:** -45°C to +70°C.

### Mechanical Data

**Mounting:** Socket mount, printed circuit board, top flange.

**Termination:** .187" (4.75mm) quick connect/solder terminals, or printed circuit terminals.

**Enclosure:** Smoke-color polycarbonate dust cover.

**Weight:** 1.8 oz. (51g) approximately.

### Ordering Information

Typical Part No. ▶

**K10**

**P**

**-11**

**D**

**1**

**5**

**-6**

**1. Basic Series:**

K10 = 15 amp miniature relay.

**2. Cover:**

P = Polycarbonate (smoke color).

**3. Contact Arrangement:**

11 = 2 Form C (DPDT)

**4. Coil Input:**

A = 50/60 Hz. AC      D = DC

**5. Mounting & Termination:**

1 = Socket mount; .187" (4.75mm) quick connect/solder terminals.

5 = Printed circuit terminals; .160" length.

T = Mounting bracket on end of cover; .187" (4.75mm) quick connect/solder terminals.

**6. Contact Type:**

5 = 15 amp silver-cadmium oxide

**7. Coil Voltage:**

To 240VAC or 110VDC, see coil data table.

**Stock Items – The following items are normally maintained in stock for immediate delivery.**

K10P-11A15-6	K10P-11D15-6	K10P-11D55-24
K10P-11A15-12	K10P-11D15-12	K10P-11D55-110
K10P-11A15-24	K10P-11D15-24	K10P-11DT5-12
K10P-11A15-120	K10P-11D15-110	K10P-11DT5-24
K10P-11AT5-120	K10P-11D55-12	

### Outline Dimensions

**Mounting Code 1  
Socket Mount**

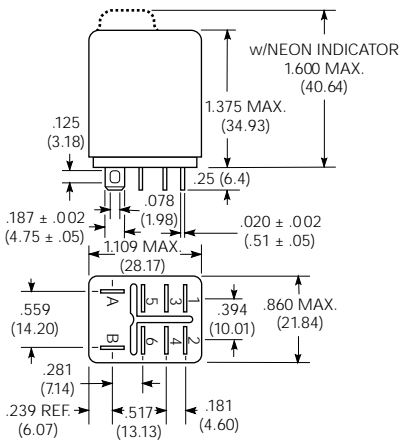

**Mounting Code 5  
Printed Circuit Terminals**

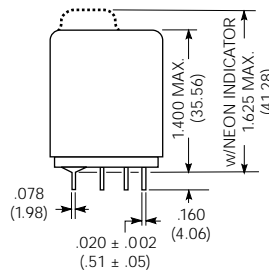

**Mounting Code T**

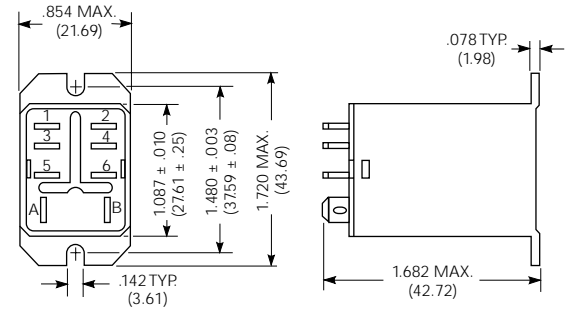

### PC Board Layout

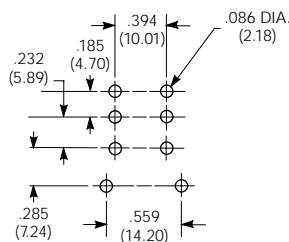

### Wiring Diagram

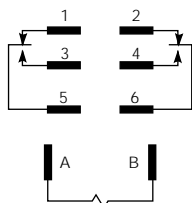

**Sockets and Accessories for K10 Relays**

Sockets for K10 series relays are rated 10 amps, and are UL recognized, File E59244, and CSA certified, File LR15734.

**27E488**  
Pierced Solder Terminals

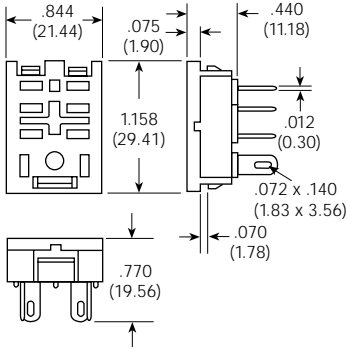

**20C217**  
Hold Down Spring For 27E488 & 27E489

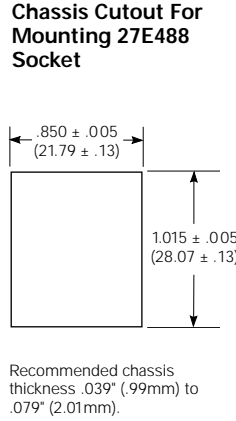

Socket punch Greenlee part 5015115.0, Type 731R available from Greenlee Tool Co., Rockford, Illinois.

**37D633**  
Mounting Strip

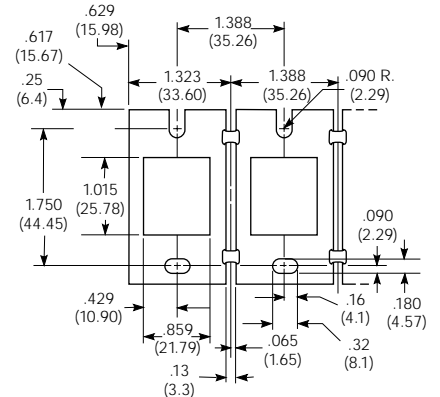

37D633 will mount eight 27E488 sockets in one length of aluminum strip measuring 10.97" x 2.25" x .062". (278.64 x 57.15 x 1.57)

**27E489**  
Printed Circuit Terminals

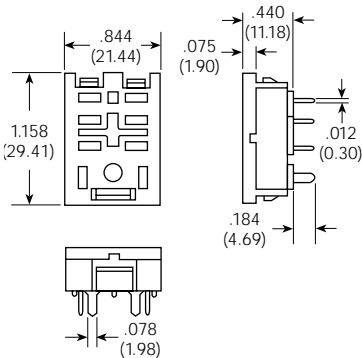

**PC. Board Layout For Socket**

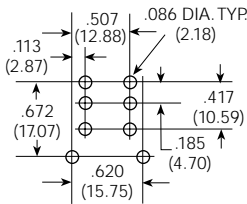

**Note:** PC. terminal socket will also fit PC. board layout for relay. However, in order to accomplish this, terminals must be formed accordingly.

**Caution:** Printed circuit sockets are manufactured with "floating" (loose) terminals. This permits them to align with holes in the circuit board and with the relay terminals. During the mounting and soldering of the socket, vertical float should be eliminated and the terminals seated on the board. (This may be accomplished by inserting a dummy relay in the socket.) Failure to eliminate float may cause fracture of the solder joint or separation of the copper conductor from the printed circuit board when a relay is inserted in the socket after soldering.

**27E895**  
Screw Terminals, DIN Rail Snap-Mount  
(Use with mounting track 24A110)

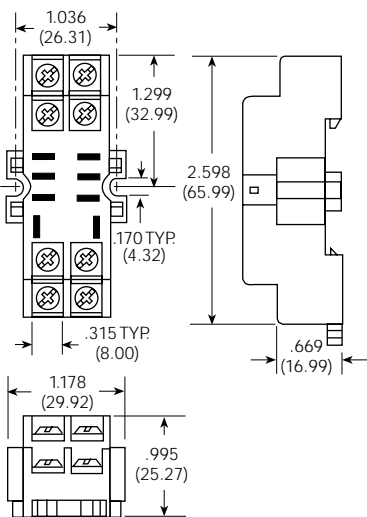

**Terminal Location**

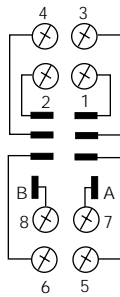

**27E487**  
Screw Terminals

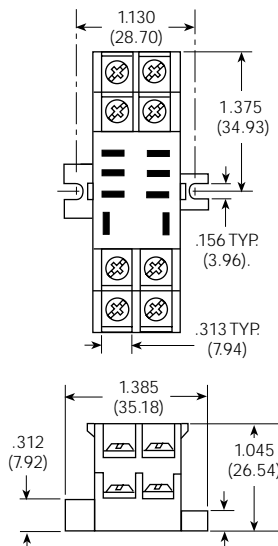

**Terminal Location**

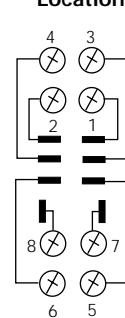

**20C297**  
Hold Down Spring For 27E487

