

NAIS

POWER PhotoMOS RELAYS
1-channel (Form B) Type

PhotoMOS
RELAYS

FEATURES

1. High capacity

A maximum 0.5A load can be controlled with a 5 mA input current. The ON resistance is low at 2.8Ω (typ.)

2. 1 Form B

This has been realized thanks to the built-in MOSFET processed by our proprietary method, DSD (Double-diffused and Selective Doping) method.

3. Compact slim-type 4-pin SIL

(W)3.5×(D)21.0×(H)12.5 mm
(W).138×(D).827×(H).492 inch×
The compact size of the 4-pin SIL package allows high density mounting.

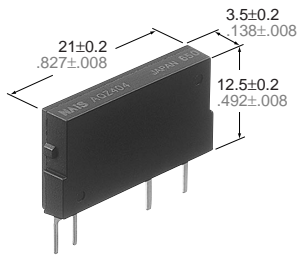

mm inch

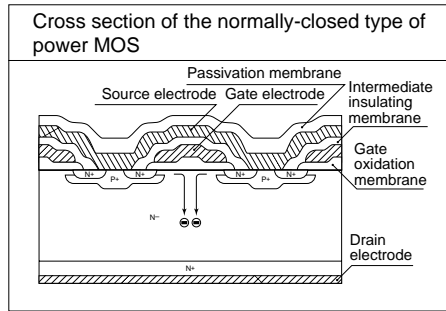

TYPICAL APPLICATIONS

- Railroad, traffic signals
- Measurement instruments
- Testing equipment

TYPES

AC/DC type

Output rating*		Part No.	Packing quantity	
Load voltage	Load current		Inner carton	Outer carton
400 V	0.5 A	AQZ404	25 pcs	500 pcs

RATING

1) Absolute maximum ratings (Ambient temperature: 25°C 77°F)

Item		Symbol	AQZ104	Remarks
Input	LED forward current	I _F	50 mA	
	LED reverse voltage	V _R	3 V	
	Peak forward current	I _{FP}	1 A	f = 100 Hz, Duty factor = 0.1%
	Power dissipation	P _{in}	75 mW	
Output	Load voltage (Peak AC)	V _L	400 V	
	Continuous load current (Peak AC)	I _L	0.5 A	
	Peak load current	I _{peak}	1.5 A	100 ms (1 shot), V _L = DC
	Power dissipation	P _{out}	1.6 W	
Total power dissipation		P _T	1.6 W	
I/O isolation voltage		V _{iso}	2,500 V AC	
Temperature limits	Operating	T _{opr}	-40°C to +85°C -40°F to +185°F	Non-condensing at low temperatures
	Storage	T _{stg}	-40°C to +100°C -40°F to +212°F	

AQZ404

2) Electrical characteristics (Ambient temperature: 25°C 77°F)

Item		Symbol	AQZ404	Condition		
Input	LED operate (OFF) current	Typical	1.0 mA	$I_L = 100 \text{ mA}$ $V_L = 10 \text{ V}$		
		Maximum	3.0 mA			
	LED reverse (ON) current	Minimum	0.4 mA	$I_L = 100 \text{ mA}$ $V_L = 10 \text{ V}$		
		Typical	0.9 mA			
LED dropout voltage	Typical	V_F	1.25 V (1.16 V at $I_F = 10 \text{ mA}$)	$I_F = 50 \text{ mA}$		
	Maximum		1.5 V			
Output	On resistance	Typical	2.8 Ω	$I_F = 0$ $I_L = \text{Max.}$ Within 1 s on time		
		Maximum	4.0 Ω			
	Off state leakage current	Maximum	I_{Leak}	10 μA	$I_F = 10 \text{ mA}$ $V_L = \text{Max.}$	
Transfer characteristics	Switching speed	Operating (OFF) time*	T_{off}	Typical	3.9 ms	$I_F = 0 \rightarrow 10 \text{ mA}$ $I_L = 100 \text{ mA}$ $V_L = 10 \text{ V}$
				Maximum	7.5 ms	
				Typical	9.4 ms	$I_F = 0 \rightarrow 5 \text{ mA}$ $I_L = 100 \text{ mA}$ $V_L = 10 \text{ V}$
				Maximum	15 ms	
	Reverse (ON) time*	T_{on}	Typical	0.8 ms	$I_F = 5 \text{ mA} \rightarrow 0$ or $10 \text{ mA} \rightarrow 0$ $I_L = 100 \text{ mA}$ $V_L = 10 \text{ V}$	
			Maximum	3.0 ms		
	I/O capacitance		Typical	C_{iso}	0.8 pF	$f = 1 \text{ MHz}$ $V_B = 0$
			Maximum		1.5 pF	
	Initial I/O isolation resistance		Minimum	R_{iso}	1,000 M Ω	500 V DC
	Maximum operating frequency		Maximum	—	0.5 cps	$I_F = 10 \text{ mA}$ Duty factor = 50% $I_L = \text{Max.}, V_L = \text{Max.}$

Note: Recommendable LED forward current $I_F = 5$ to 10 mA.

*Operate/Reverse time

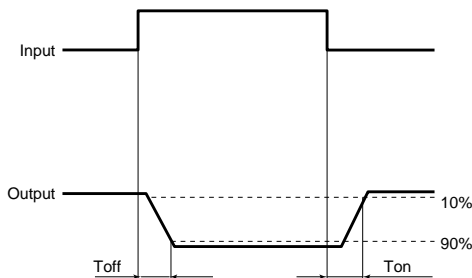

- For Dimensions, see Page 442.
- For Schematic and Wiring Diagrams, see Page 448.
- For Cautions for Use, see Page 453.

REFERENCE DATA

1. Load current vs. ambient temperature characteristics

Allowable ambient temperature: -40°C to $+85^\circ\text{C}$
 -40°F to $+185^\circ\text{F}$

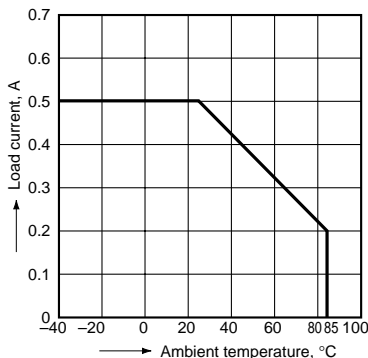

2. Load current vs. ambient temperature characteristics in adjacent mounting

I_L : Load current;
 $I_L(\text{max.})$: Maximum continuous load current

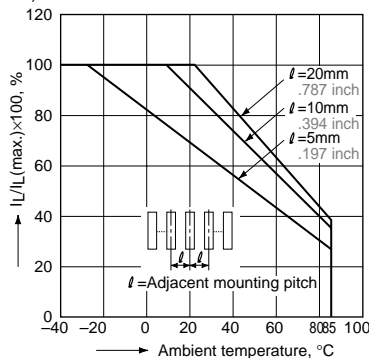

3. On resistance vs. ambient temperature characteristics

LED current: 0 mA; Load voltage: Max. (DC)
Continuous load current: Max. (DC)

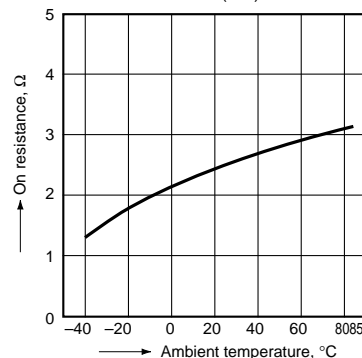

4. Operate (OFF) time vs. ambient temperature characteristics

LED current: 10 mA; Load voltage: 10 V (DC);
Continuous load current: 100 mA (DC)

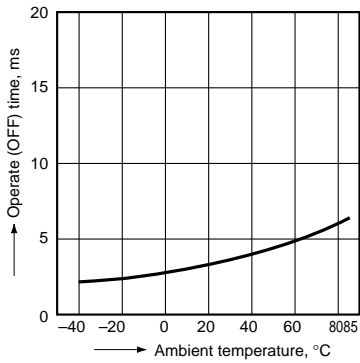

5. Reverse (ON) time vs. ambient temperature characteristics

LED current: 10 mA; Load voltage: 10 V (DC);
Continuous load current: 100 mA (DC)

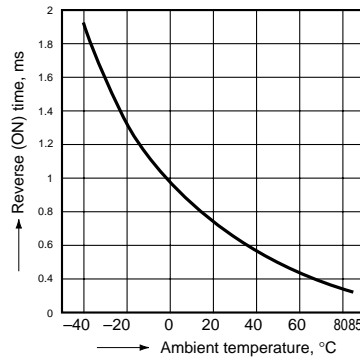

6. LED operate (OFF) current vs. ambient temperature characteristics

Load voltage: 10 V (DC);
Continuous load current: 100 mA (DC)

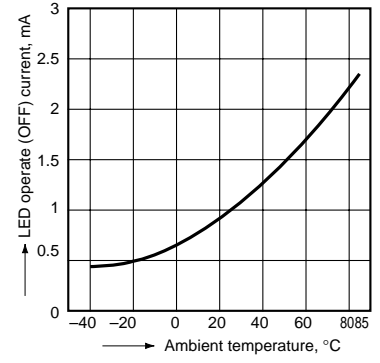

7. LED reverse (ON) current vs. ambient temperature characteristics

Load voltage: 10 V (DC);
Continuous load current: 100 mA (DC)

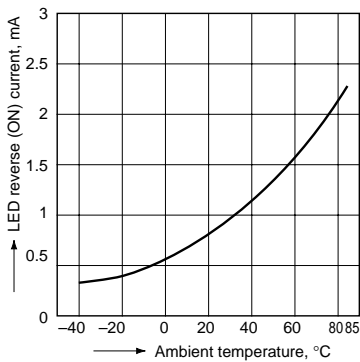

8. LED dropout voltage vs. ambient temperature characteristics

Sample: all types; LED current: 5 to 50 mA

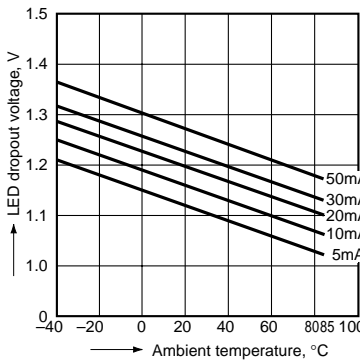

9. Voltage vs. current characteristics of output at MOS portion

Ambient temperature: 25°C 77°F

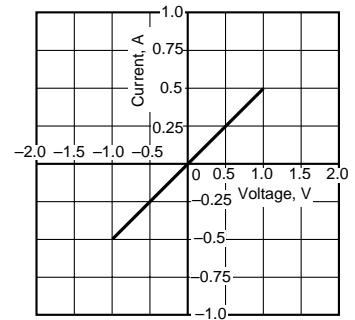

10. Off state leakage current

Ambient temperature: 25°C 77°F

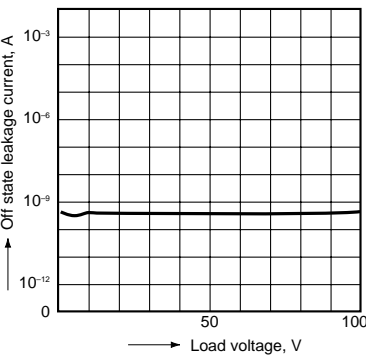

11. LED forward current vs. operate (OFF) time characteristics

Load voltage: 10 V (DC); Continuous load current: 100 mA (DC); Ambient temperature: 25°C 77°F

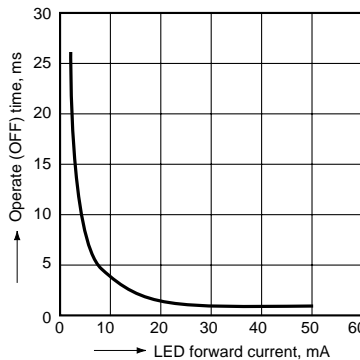

12. LED forward current vs. reverse (ON) time characteristics

Load voltage: 10 V (DC); Continuous load current: 100 mA (DC); Ambient temperature: 25°C 77°F

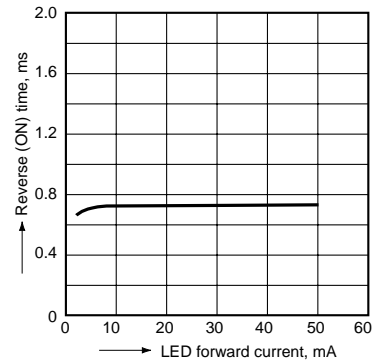

13. Maximum operating frequency vs. load voltage/current characteristics

LED current: 10 mA;
Ambient temperature: 25°C 77°F

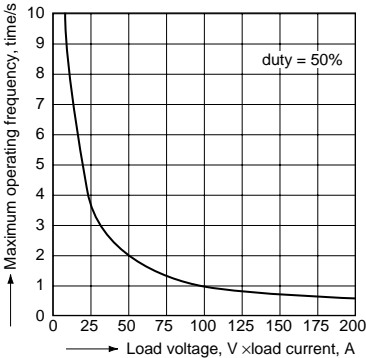

14. Applied voltage vs. output capacitance characteristics

Frequency: 1 MHz;
Ambient temperature: 25°C 77°F

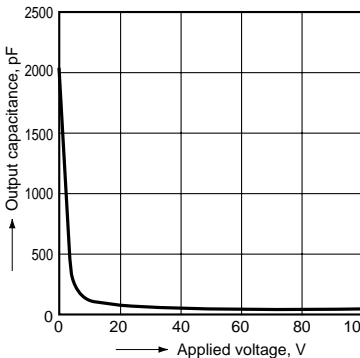

AQZ404

ACCESSORY

mm inch

Socket

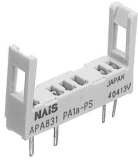

Standard type

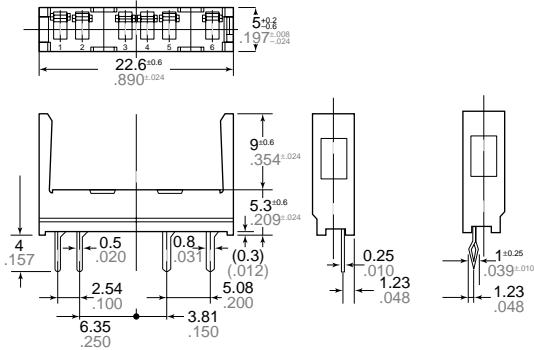

PA1a-PS

General Tolerance: $\pm 0.3 \pm 0.012$

Self clinching type

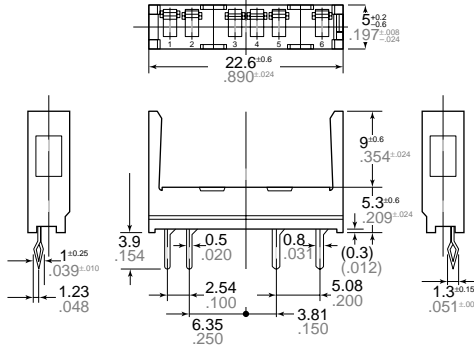

PA1a-PS-H

General Tolerance: $\pm 0.3 \pm 0.012$

PC board pattern (BOTTOM VIEW)



Self clinching type

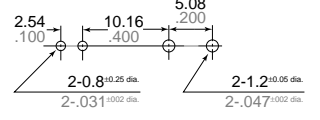

Tolerance: $\pm 0.1 \pm 0.004$