

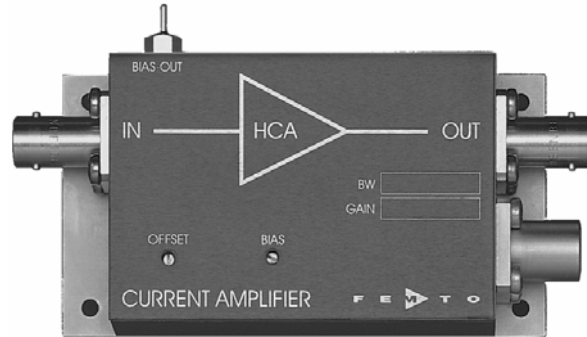

Datasheet

HCA-400M-5K-C

High Speed Current Amplifier



Features	<ul style="list-style-type: none"> • Bandwidth DC ... 400 MHz • Rise / Fall Time 1 ns • Exceptional Low Pulse Distortion – Almost No Overshoot or Ringing will Occur • Approx. Bessel Characteristic Optimized for Accurate Pulse Response • Transimpedance (Gain) 5×10^3 V/A 																																																				
Applications	<ul style="list-style-type: none"> • Photodiode and Photomultiplier Amplifier • Spectroscopy • Ionisation Detectors • Ideal for Analyzing Digital Signals (No Baseline Shift at any Digital Code) • Preamplifier for A/D Converters, Digitizers etc. 																																																				
Specifications	<table border="0"> <tr> <td></td> <td><i>Test Conditions</i></td> <td><i>Vs = ± 15 V, Ta = 25°C</i></td> </tr> <tr> <td rowspan="2">Gain</td> <td>Transimpedance</td> <td>5×10^3 V/A (@ 50 Ω load)</td> </tr> <tr> <td>Gain Accuracy</td> <td>± 2 %</td> </tr> <tr> <td rowspan="5">Frequency Response</td> <td>Lower Cut-Off Frequency</td> <td>DC</td> </tr> <tr> <td>Upper Cut-Off Frequency (- 3 dB)</td> <td>400 MHz (± 10 %, @ Csource 2 to 4 pF)</td> </tr> <tr> <td></td> <td>350 MHz (± 10 %, @ Csource 5 to 10 pF)</td> </tr> <tr> <td>Max. Source Capacitance</td> <td>10 pF (incl. cable, e.g. typical coax cable 1 pF/ cm)</td> </tr> <tr> <td>Rise / Fall Time (10 % - 90 %)</td> <td>1.0 ns (@ Csource 2 to 4 pF)</td> </tr> <tr> <td rowspan="10">Input</td> <td></td> <td>1.3 ns (@ Csource 5 to 10 pF)</td> </tr> <tr> <td>Gain Flatness</td> <td>± 0.3 dB</td> </tr> <tr> <td>Equ. Input Noise Current</td> <td>21 pA/√Hz (@ 100 MHz)</td> </tr> <tr> <td>Equ. Input Noise Voltage</td> <td>3.5 nV/√Hz (@ 100 MHz)</td> </tr> <tr> <td>Equ. Integrated Noise</td> <td>5 μA peak-peak (independent of Csource)</td> </tr> <tr> <td>Input Bias Current</td> <td>2 μA typ.</td> </tr> <tr> <td>Input Bias Current Drift</td> <td>0.07 μA / °C</td> </tr> <tr> <td>Offset Current Compensation</td> <td>± 200 μA, adjustable by offset trimpot</td> </tr> <tr> <td>Input Current Range</td> <td>± 200 μA (for linear amplification)</td> </tr> <tr> <td>Input Offset Voltage</td> <td>< 2 mV</td> </tr> <tr> <td>DC Input Impedance</td> <td>50 Ω (virtual) // 5 pF</td> </tr> <tr> <td rowspan="3">Output</td> <td>Output Voltage Range</td> <td>± 1.0 V (@ 50 Ω load) for linear operation and low harmonic distortion</td> </tr> <tr> <td>Max. Output Voltage Range</td> <td>± 1.5 V (@ 50 Ω load)</td> </tr> <tr> <td>Output Impedance</td> <td>50 Ω (terminate with 50 Ω load for best performance)</td> </tr> <tr> <td>Bias Output</td> <td colspan="2"> SUNSTAR自动化 http://www.sensor-ic.com/ TEL: 0755-83376489 FAX:0755-83376182 E-MAIL:szss20@163.com Bias Output Voltage Range ± 12 V, adjustable by bias trimpot Bias Output Impedance 10 kΩ // 1 μF </td> </tr> </table>		<i>Test Conditions</i>	<i>Vs = ± 15 V, Ta = 25°C</i>	Gain	Transimpedance	5×10^3 V/A (@ 50 Ω load)	Gain Accuracy	± 2 %	Frequency Response	Lower Cut-Off Frequency	DC	Upper Cut-Off Frequency (- 3 dB)	400 MHz (± 10 %, @ Csource 2 to 4 pF)		350 MHz (± 10 %, @ Csource 5 to 10 pF)	Max. Source Capacitance	10 pF (incl. cable, e.g. typical coax cable 1 pF/ cm)	Rise / Fall Time (10 % - 90 %)	1.0 ns (@ Csource 2 to 4 pF)	Input		1.3 ns (@ Csource 5 to 10 pF)	Gain Flatness	± 0.3 dB	Equ. Input Noise Current	21 pA/√Hz (@ 100 MHz)	Equ. Input Noise Voltage	3.5 nV/√Hz (@ 100 MHz)	Equ. Integrated Noise	5 μA peak-peak (independent of Csource)	Input Bias Current	2 μA typ.	Input Bias Current Drift	0.07 μA / °C	Offset Current Compensation	± 200 μA, adjustable by offset trimpot	Input Current Range	± 200 μA (for linear amplification)	Input Offset Voltage	< 2 mV	DC Input Impedance	50 Ω (virtual) // 5 pF	Output	Output Voltage Range	± 1.0 V (@ 50 Ω load) for linear operation and low harmonic distortion	Max. Output Voltage Range	± 1.5 V (@ 50 Ω load)	Output Impedance	50 Ω (terminate with 50 Ω load for best performance)	Bias Output	SUNSTAR自动化 http://www.sensor-ic.com/ TEL: 0755-83376489 FAX:0755-83376182 E-MAIL:szss20@163.com Bias Output Voltage Range ± 12 V, adjustable by bias trimpot Bias Output Impedance 10 kΩ // 1 μF	
	<i>Test Conditions</i>	<i>Vs = ± 15 V, Ta = 25°C</i>																																																			
Gain	Transimpedance	5×10^3 V/A (@ 50 Ω load)																																																			
	Gain Accuracy	± 2 %																																																			
Frequency Response	Lower Cut-Off Frequency	DC																																																			
	Upper Cut-Off Frequency (- 3 dB)	400 MHz (± 10 %, @ Csource 2 to 4 pF)																																																			
		350 MHz (± 10 %, @ Csource 5 to 10 pF)																																																			
	Max. Source Capacitance	10 pF (incl. cable, e.g. typical coax cable 1 pF/ cm)																																																			
	Rise / Fall Time (10 % - 90 %)	1.0 ns (@ Csource 2 to 4 pF)																																																			
Input		1.3 ns (@ Csource 5 to 10 pF)																																																			
	Gain Flatness	± 0.3 dB																																																			
	Equ. Input Noise Current	21 pA/√Hz (@ 100 MHz)																																																			
	Equ. Input Noise Voltage	3.5 nV/√Hz (@ 100 MHz)																																																			
	Equ. Integrated Noise	5 μA peak-peak (independent of Csource)																																																			
	Input Bias Current	2 μA typ.																																																			
	Input Bias Current Drift	0.07 μA / °C																																																			
	Offset Current Compensation	± 200 μA, adjustable by offset trimpot																																																			
	Input Current Range	± 200 μA (for linear amplification)																																																			
	Input Offset Voltage	< 2 mV																																																			
DC Input Impedance	50 Ω (virtual) // 5 pF																																																				
Output	Output Voltage Range	± 1.0 V (@ 50 Ω load) for linear operation and low harmonic distortion																																																			
	Max. Output Voltage Range	± 1.5 V (@ 50 Ω load)																																																			
	Output Impedance	50 Ω (terminate with 50 Ω load for best performance)																																																			
Bias Output	SUNSTAR自动化 http://www.sensor-ic.com/ TEL: 0755-83376489 FAX:0755-83376182 E-MAIL:szss20@163.com Bias Output Voltage Range ± 12 V, adjustable by bias trimpot Bias Output Impedance 10 kΩ // 1 μF																																																				

Datasheet

HCA-400M-5K-C

High Speed Current Amplifier

Specifications (continued)		
Power Supply	Supply Voltage	$\pm 15\text{ V}$
	Supply Current	$\pm 60\text{ mA typ.}$ (depends on operating conditions, recommended power supply capability minimum $\pm 150\text{ mA}$)
Case	Weight	210 g (0.5 lbs)
	Material	AlMg4.5Mn, nickel-plated
Temperature Range	Storage Temperature	$-40 \dots +100\text{ }^\circ\text{C}$
	Operating Temperature	$0 \dots +60\text{ }^\circ\text{C}$

Absolute Maximum Ratings	Input Voltage	$\pm 5\text{ V}$
	Power Supply Voltage	$\pm 22\text{ V}$

Connectors	Input	BNC
	Output	BNC
	Power Supply	LEMO series 1S, 3-pin fixed socket
		Pin 1: $+15\text{ V}$
		Pin 2: -15 V
		Pin 3: GND

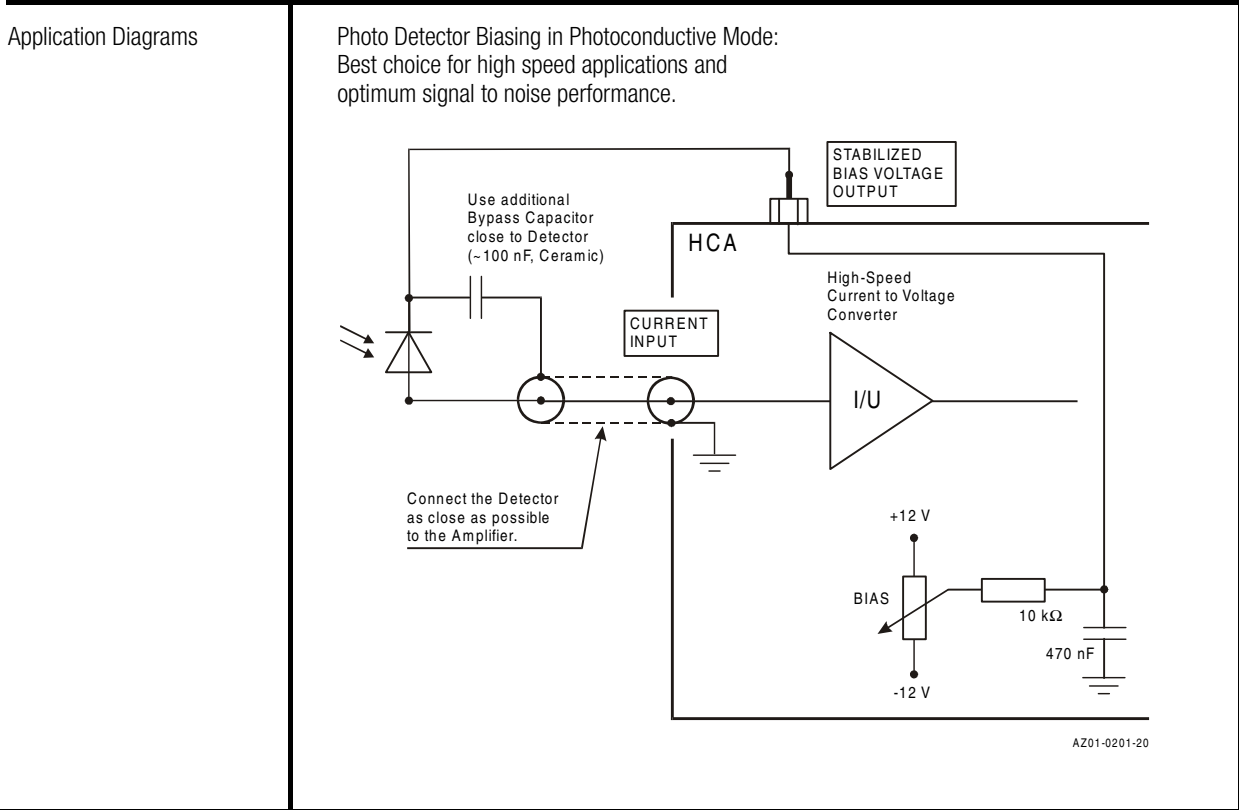
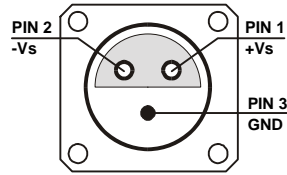

High Speed Current Amplifier

Typical Performance Characteristics

Frequency Response

Offs 16.0 dB RBW 3 MHz
 Att 0 dB * VBW 10 kHz M1[1] -2.94 dB
 Ref -4.0 dBm SWT 130ms 410.000000000 MHz

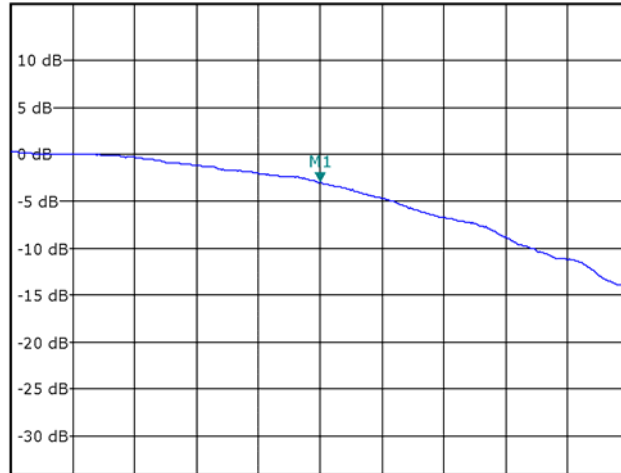

Start 20.0 MHz Stop 800.0 MHz

Noise Spectrum

Att 0 dB RBW 3 MHz
 Ref 22.4 mV * VBW 3 kHz Noise2 219.730591 nV/√Hz
 SWT 180ms Noise1 102.946035 nV/√Hz

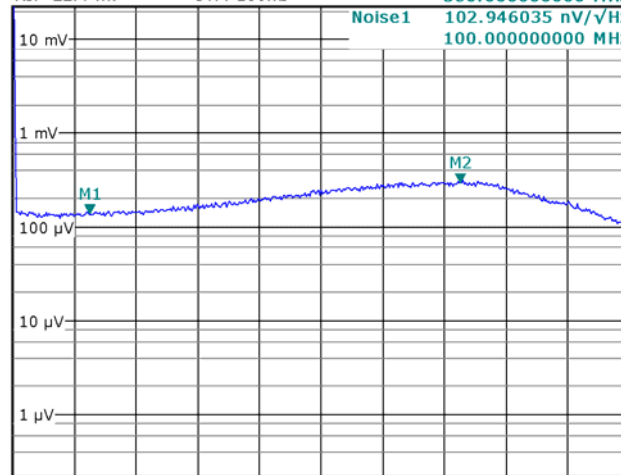

Start 0.0 Hz Stop 800.0 MHz

Note: Spectral noise data is measured at the amplifier output with open but shielded input. To determine the spectral input noise divide the measured output noise by the amplifier gain of 5×10^3 V/A, i.e.:

Marker	Frequency	Output Noise	Resulting Input Noise
1	100 MHz	103 nV/√Hz	21 pA√Hz
2	580 MHz	220 nV/√Hz	44 pA√Hz

Datasheet

HCA-400M-5K-C

High Speed Current Amplifier

Typical Performance Characteristics
(continued)

Output signal for 1 MHz, 400 μ A peak-peak input signal (sinusoidal and square wave)

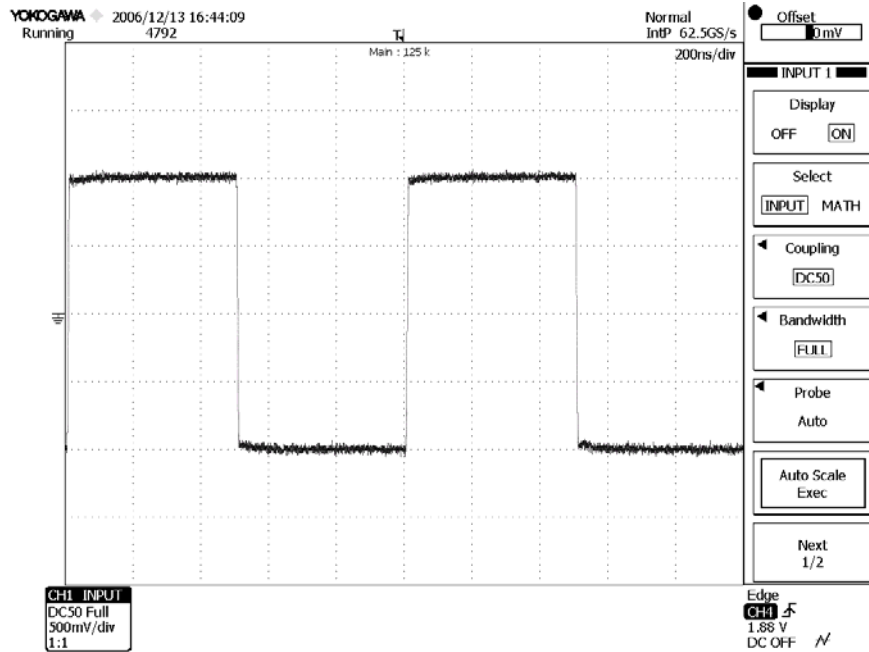
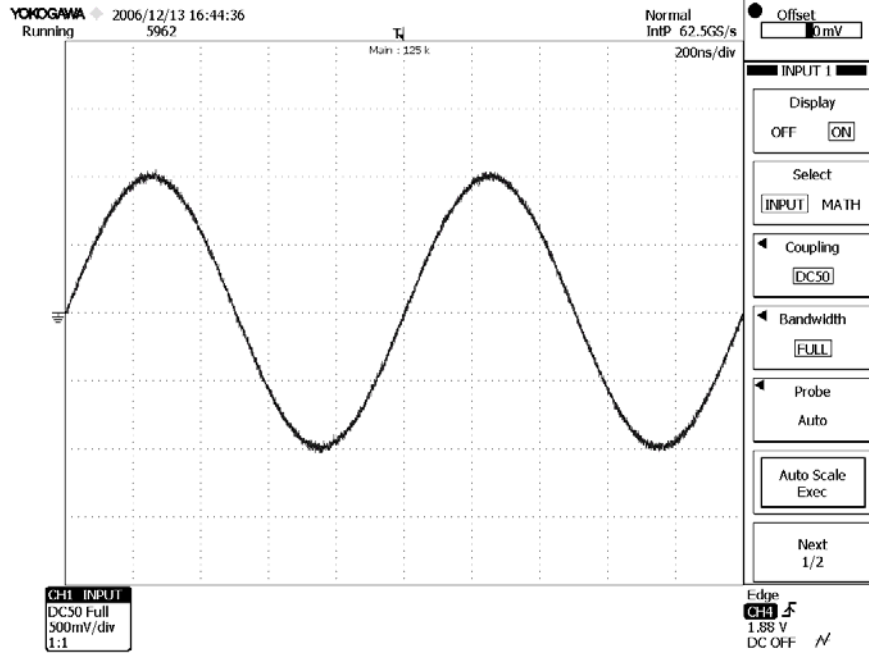

High Speed Current Amplifier

Typical Performance Characteristics (continued)

Output signal for 1MHz, 2.4 μ A peak-peak square wave input signal (without and with 64 times averaging)

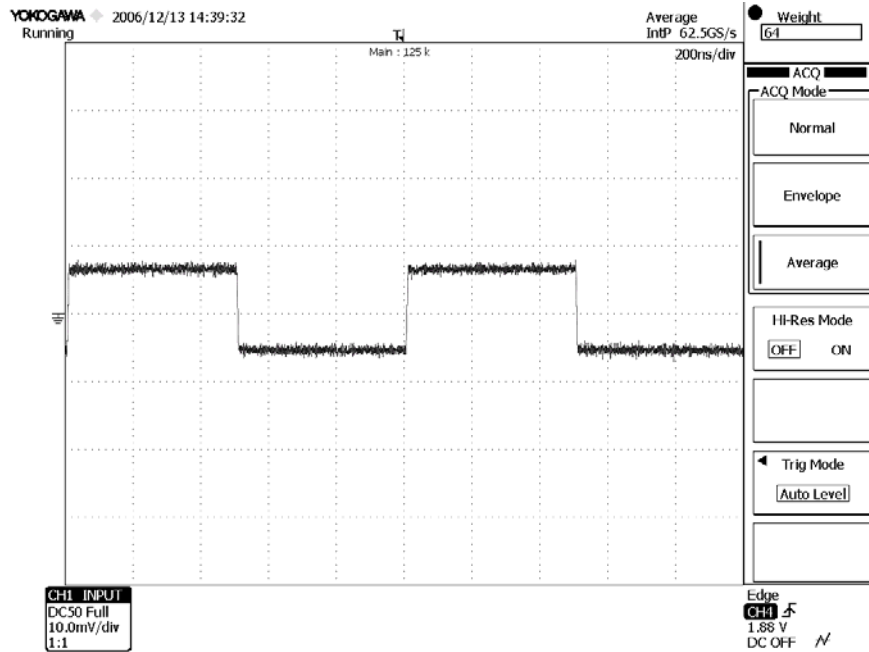
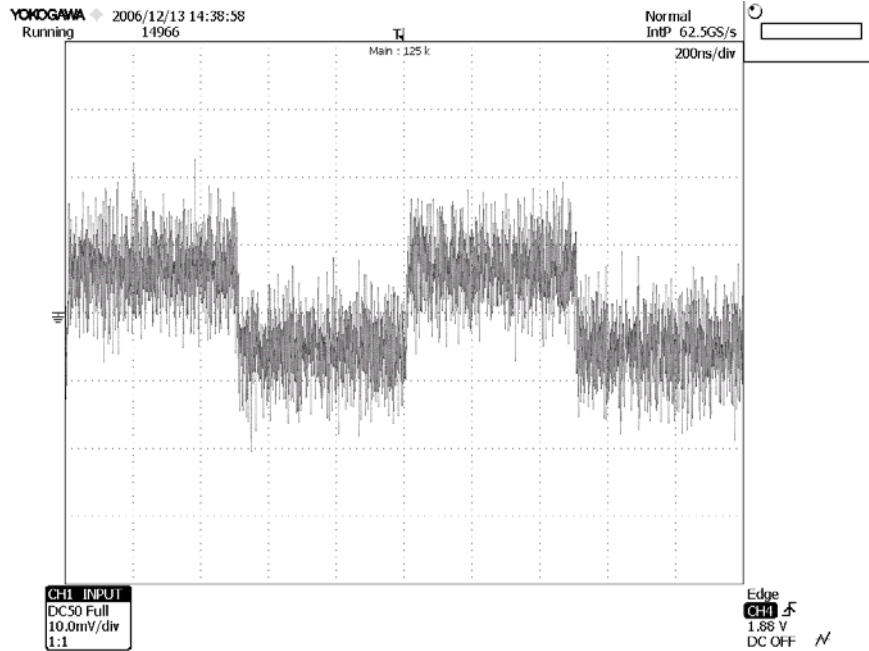

Datasheet

HCA-400M-5K-C

High Speed Current Amplifier

Typical Performance Characteristics (continued)

Pulse response for square wave input signal (16 times averaged)

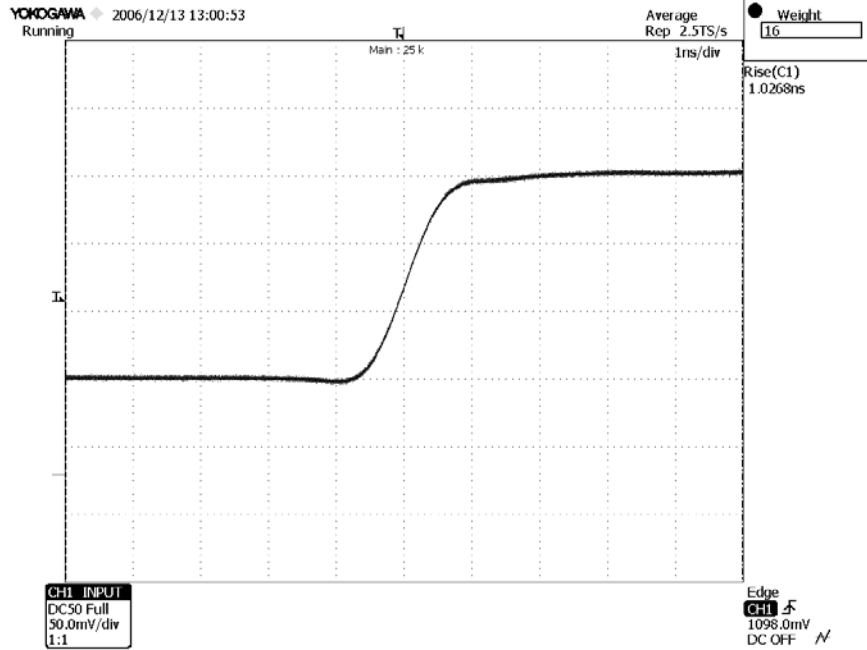

Dimensions

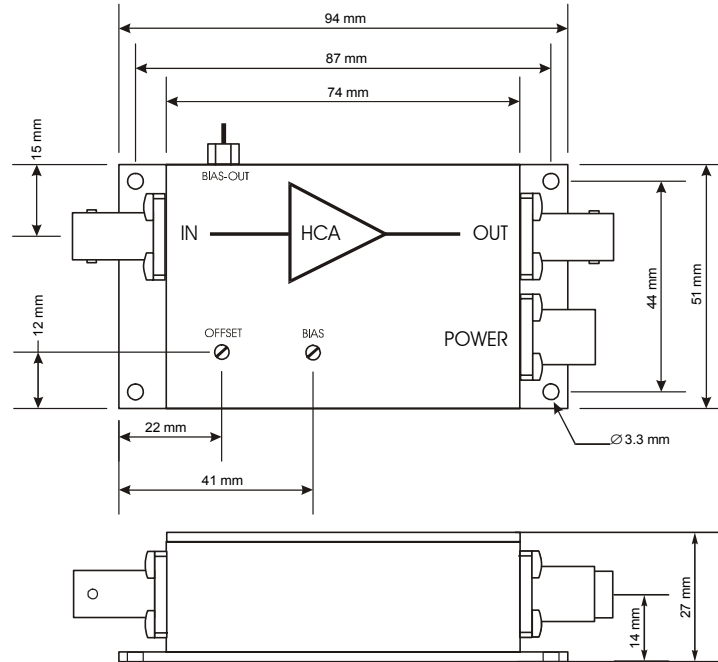

D201-0201-22

FEMTO Messtechnik GmbH
Paul-Lincke-Ufer 34
D-10999 Berlin · Germany
Tel.: +49 (0)30 - 4 46 93 86
Fax: +49 (0)30 - 4 46 93 88
e-mail: info@femto.de
<http://www.femto.de>

Specifications are subject to change without notice. Information furnished herein is believed to be accurate and reliable. However, no responsibility is assumed by FEMTO Messtechnik GmbH for its use, nor for any infringement of patents or other rights granted by implication or otherwise under any patent rights of FEMTO Messtechnik GmbH. Product names mentioned may also be trademarks used here for identification purposes only.

© by FEMTO Messtechnik GmbH
Printed in Germany

SOPHISTICATED TOOLS FOR SIGNAL RECOVERY

