

Xtrinsic MMA8653FC 3-Axis, 10-bit Digital Accelerometer

The MMA8653FC is an intelligent, low-power, three-axis, capacitive micromachined accelerometer with 10 bits of resolution. This accelerometer is packed with embedded functions with flexible user-programmable options, configurable to two interrupt pins. Embedded interrupt functions enable overall power savings, by relieving the host processor from continuously polling data. There is access to either low-pass or high-pass filtered data, which minimizes the data analysis required for jolt detection and faster transitions. The device can be configured to generate inertial wake-up interrupt signals from any combination of the configurable embedded functions, enabling the MMA8653FC to monitor inertial events while remaining in a low-power mode during periods of inactivity. The MMA8653FC is available in a small 10-pin DFN package (2 mm x 2 mm x 1 mm).

Features

- 1.95 V to 3.6 V supply voltage
- 1.62 V to 3.6 V digital interface voltage
- ± 2 g, ± 4 g, and ± 8 g dynamically selectable full-scale ranges
- Output Data Rates (ODR) from 1.56 Hz to 800 Hz
- 10-bit digital output
- I²C digital output interface with programmable interrupts
- One embedded channel of configurable motion detection (Freefall)
- Orientation (Portrait/Landscape) detection with fixed hysteresis of 15°.
- Configurable automatic ODR change triggered by the Auto-Wake/Sleep state change
- Self-Test

Typical applications

- Tilt compensation in e-compass applications
- Static orientation detection (Portrait/Landscape, Up/Down, Left/Right, Back/Front position identification)
- Notebook, tablet, e-reader, and laptop tumble and freefall detection
- Real-time orientation detection (virtual reality and gaming 3D user orientation feedback)
- Real-time activity analysis (pedometer step counting, freefall drop detection for HDD, dead-reckoning GPS backup)
- Motion detection for portable product power saving (Auto-SLEEP and Auto-WAKE for cell phone, PDA, GPS, gaming)
- Shock and vibration monitoring (mechatronic compensation, shipping and warranty usage logging)
- User interface (tilt menu scrolling)

MMA8653FC

Top and Bottom View



10-PIN DFN
2 mm x 2 mm x 1 mm
CASE 2162

Top View

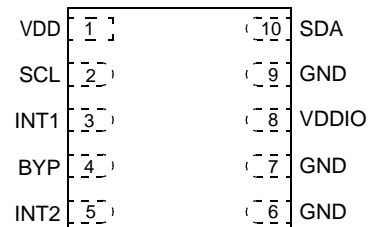

Pin Connections

ORDERING INFORMATION

Part Number	Temperature Range	Package Description	Shipping
MMA8653FCR1	-40°C to +85°C	DFN-10	Tape and Reel

Freescale reserves the right to change the detail specifications as may be required to permit improvements in the design of its products.

© 2013–2014 Freescale Semiconductor, Inc. All rights reserved.

Table 1. Feature comparison of the MMA865xFC devices

Feature	MMA8652FC	MMA8653FC
ADC Resolution (bits)	12	10
Digital Sensitivity in 2 g mode (counts/g)	1024	256
Low-Power Mode	Yes	Yes
Auto-WAKE	Yes	Yes
Auto-SLEEP	Yes	Yes
32-Level FIFO	Yes	No
Low-Pass Filter	Yes	Yes
High-Pass Filter	Yes	No
Transient Detection with High-Pass Filter	Yes	No
Fixed Orientation Detection	No	Yes
Programmable Orientation Detection	Yes	No
Data-Ready Interrupt	Yes	Yes
Single-Tap Interrupt	Yes	No
Double-Tap Interrupt	Yes	No
Directional Tap Interrupt	Yes	No
Freefall Interrupt	Yes	Yes
Motion Interrupt with Direction	Yes	No

MMA8653FC

Contents

1	Block Diagram and Pin Descriptions	4
1.1	Block diagram	4
1.2	Pin descriptions	5
1.3	Typical application circuit	5
2	Mechanical and Electrical Specifications	6
2.1	Absolute maximum ratings	6
2.2	Mechanical characteristics	7
2.3	Electrical characteristics	8
2.4	I2C interface characteristic	9
3	Terminology	10
3.1	Sensitivity	10
3.2	Zero-g offset	10
3.3	Self-Test	10
4	Modes of Operation	11
5	Functionality	12
5.1	Device calibration	12
5.2	8-bit or 12-bit	12
5.3	Internal FIFO data buffer	13
5.4	Low power modes vs. high resolution modes	13
5.5	Auto-WAKE/SLEEP mode	14
5.6	Freefall and motion detection	14
5.7	Transient detection	14
5.8	Tap detection	15
5.9	Orientation detection	15
5.10	Interrupt register configurations	17
5.11	Serial I2C interface	17
6	Register Descriptions	20
6.1	Register address map	20
6.2	Register bit map	22
6.3	Data registers	24
6.4	FIFO registers	26
6.5	System status and ID registers	28
6.6	Data configuration registers	30
6.7	Portrait/Landscape configuration and status registers	32
6.8	Freefall/Motion configuration and status registers	36
6.9	Transient configuration and status registers	41
6.10	Pulse configuration and status registers	44
6.11	Auto-WAKE/SLEEP detection	51
6.12	System and control registers	52
6.13	Data calibration registers	57
7	Mounting Guidelines	58
7.1	Overview of soldering considerations	58
7.2	Halogen content	58
7.3	PCB mounting/soldering recommendations	58
8	Tape and Reel	60
8.1	Tape dimensions	60
8.2	Device orientation	60
9	Package Dimensions	61
10	Revision History	64

Related Documentation

The MMA8653FC device features and operations are described in a variety of reference manuals, user guides, and application notes. To find the most-current versions of these documents:

- Go to the Freescale homepage at:
<http://www.freescale.com/>
- In the Keyword search box at the top of the page, enter the device number MMA8653FC.
- In the Refine Your Result pane on the left, click on the Documentation link.

1 Block Diagram and Pin Descriptions

1.1 Block diagram

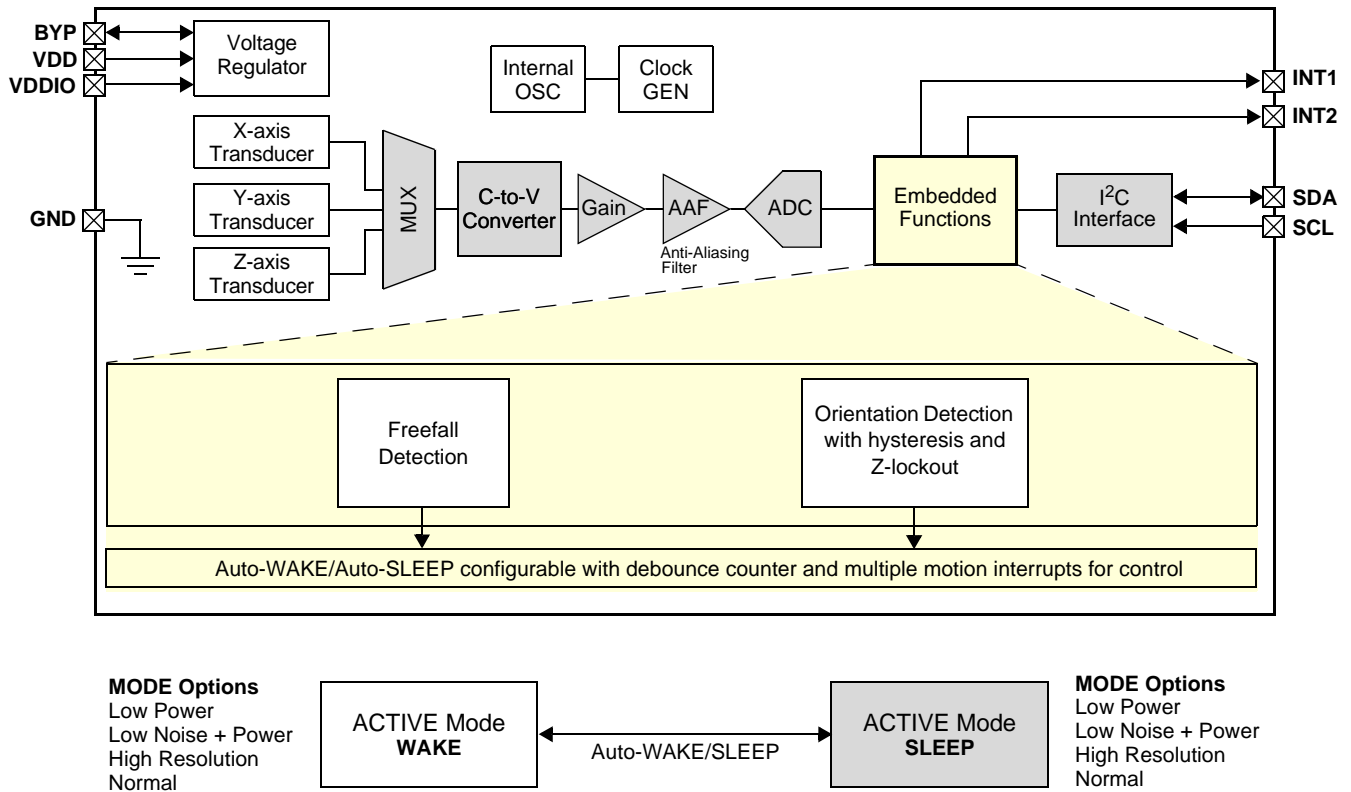

Figure 1. MMA8653 block diagram

1.2 Pin descriptions

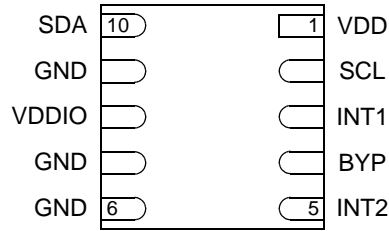

Figure 2. Pin connections (bottom view)

Table 1. Pin descriptions

Pin #	Pin Name	Description	Notes
1	VDD	Power supply	Device power is supplied through the VDD line. Power supply decoupling capacitors should be placed as close as possible to pin 1 and pin 8 of the device.
2	SCL ⁽¹⁾	I ² C Serial Clock	7-bit I ² C device address is 0x1D.
3	INT1	Interrupt 1 output	The interrupt source and pin settings are user-programmable through the I ² C interface.
4	BYP	Internal regulator output capacitor connection	
5	INT2	Interrupt 2 output	See INT1.
6	GND	Ground	
7	GND	Ground	
8	VDDIO	Digital Interface Power supply	
9	GND	Ground	
10	SDA ⁽¹⁾	I ² C Serial Data	See SCL.

1. The control signals SCL and SDA are not tolerant of voltages higher than VDDIO + 0.3 V. If VDDIO is removed, then the control signals SCL and SDA will clamp any logic signals with their internal ESD protection diodes. The SDA and SCL I²C connections are open drain, and therefore require a pullup resistor to VDDIO.

1.3 Typical application circuit

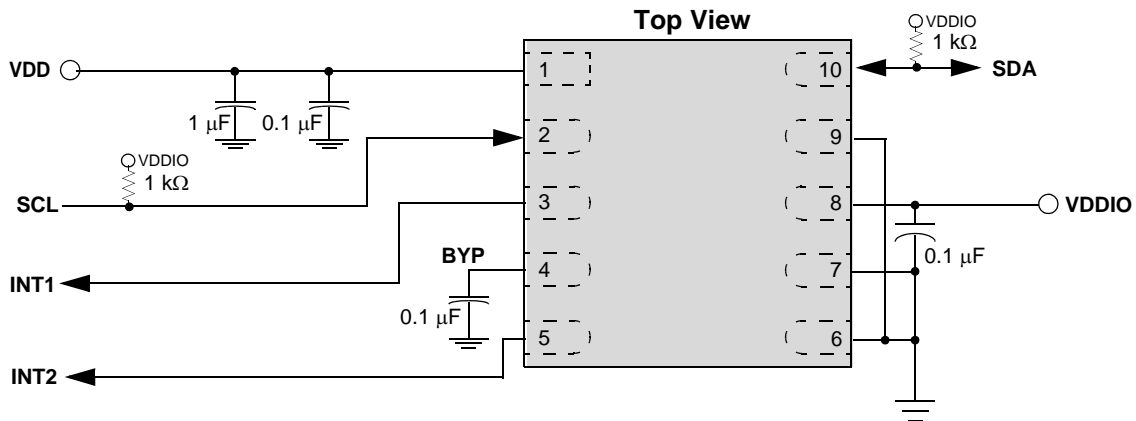

Note: 4.7 kΩ Pullup resistors on INT1/INT2 can be added for open-drain operation.

Figure 3. Typical application circuit

2 Mechanical and Electrical Specifications

2.1 Absolute maximum ratings

Stresses above those listed as “absolute maximum ratings” may cause permanent damage to the device. Exposure to maximum rating conditions for extended periods may affect device reliability.

Table 2. Maximum ratings

Rating	Symbol	Value	Unit
Maximum acceleration (all axes, 100 μ s)	g_{max}	10,000	g
Supply voltage	VDD	-0.3 to +3.6	V
Input voltage on any control pin (SCL, SDA)	V_{in}	-0.3 to VDDIO + 0.3	V
Drop test	D_{drop}	1.8	m
Operating temperature range	T_{OP}	-40 to +85	$^{\circ}C$
Storage temperature range	T_{STG}	-40 to +125	$^{\circ}C$

Table 3. ESD and latch-up protection characteristics

Rating	Symbol	Value	Unit
Human body model	HBM	± 2000	V
Machine model	MM	± 200	V
Charge device model	CDM	± 500	V
Latch-up current at $T = 85^{\circ}C$	I_{LU}	± 100	mA



This device is sensitive to mechanical shock. Improper handling can cause permanent damage to the part.



This part is ESD-sensitive. Improper handling can cause permanent damage to the part.

2.2 Mechanical characteristics

Table 4. Mechanical characteristics at VDD = 2.5 V, VDDIO = 1.8 V, T_A = 25°C, unless otherwise noted

Parameter	Symbol	Test Conditions	Min	Typ	Max	Unit
Full-Scale measurement range	FS	FS[1:0] set to 00 ±2 g mode		±2		g
		FS[1:0] set to 01 ±4 g mode		±4		
		FS[1:0] set to 10 ±8 g mode		±8		
Sensitivity	So	FS[1:0] set to 00 ±2 g mode		256		LSB/g
		FS[1:0] set to 01 ±4 g mode		128		
		FS[1:0] set to 10 ±8 g mode		64		
Sensitivity accuracy	Soa			±2.5		%
Sensitivity change vs. temperature	TCS	-40°C to 85°C		±0.0074		%/°C
Zero-g level offset accuracy ⁽¹⁾	TyOff			±25		mg
Zero-g level offset accuracy, post-board mount ⁽²⁾	TyOffPBM			±33.5		mg
Zero-g level change vs. temperature	TCO	-40°C to 85°C		±0.27		mg/°C
Self-Test output change (±2 g mode)	STOC	x		+22.5		LSB
		y		+26		
		z		+195.5		
ODR accuracy	ODRa			±3.1		%
Output data bandwidth	BW		ODR/3		ODR/2	Hz
Output noise	RMS	Normal mode ODR = 400 Hz		182		µg/√Hz
Operating temperature range	T _{AGOC}		-40		85	°C

1. Before board mount.

2. Post-board mount offset specifications are based on an 8-layer PCB, relative to 25°C.

2.3 Electrical characteristics

Table 5. Electrical characteristics at VDD = 2.5 V, VDDIO = 1.8 V, T = 25°C, unless otherwise noted

Parameter	Symbol	Test Conditions	Min	Typ	Max	Unit
Supply voltage	VDD		1.95	2.5	3.6	V
Interface supply voltage	VDDIO		1.62	1.8	3.6	V
Low Power mode	I_{ddLP}	ODR = 1.563 Hz		6.5		μA
		ODR = 6.25 Hz		6.5		
		ODR = 12.5 Hz		6.5		
		ODR = 50 Hz		15		
		ODR = 100 Hz		26		
		ODR = 200 Hz		49		
		ODR = 400 Hz		94		
Normal mode	I_{dd}	ODR = 1.563 Hz		27		μA
		ODR = 6.25 Hz		27		
		ODR = 12.5 Hz		27		
		ODR = 50 Hz		27		
		ODR = 100 Hz		49		
		ODR = 200 Hz		94		
		ODR = 400 Hz		184		
Boot-Up current	I_{ddBoot}	VDD = 2.5 V, the current during the Boot sequence is integrated over 0.5 ms, using a recommended bypass cap			1	mA
Value of capacitor on BYP pin	Cap	-40°C to 85°C	75	100	470	nF
Standby current	I_{ddStby}	25°C		1.4	5	μA
Digital high-level input voltage SCL, SDA	V_{IH}	VDD = 3.6 V, VDDIO = 3.6 V	0.7*VDDIO			V
Digital low-level input voltage SCL, SDA	V_{IL}	VDD = 1.95 V, VDDIO = 1.62 V			0.3*VDDIO	V
High-level output voltage INT1, INT2	V_{OH}	VDD = 3.6 V, VDDIO = 3.6 V, $I_O = 500 \mu\text{A}$	0.9*VDDIO			V
Low-level output voltage INT1, INT2	V_{OL}	VDD = 1.95 V, VDDIO = 1.62 V, $I_O = 500 \mu\text{A}$			0.1*VDDIO	V
Low-level output voltage SDA	V_{OLS}	$I_O = 3 \text{ mA}$			0.4	V
Output source current INT1, INT2	I_{source}	Voltage high level VOUT = 0.9 x VDDIO		2		mA
Output sink current INT1, INT2	I_{sink}	Voltage high level VOUT = 0.9 x VDDIO		3		mA
Power-on ramp time	T_{pr}		0.001		1000	ms
Boot time	T_{bt}	Time from VDDIO on and VDD > VDD min until I ² C is ready for operation, C _{by} = 100 nf		350	500	μs
Turn-on time	T_{on1}	Time to obtain valid data from Standby mode to Active mode			2/ODR + 1 ms	-
Turn-on time	T_{on2}	Time to obtain valid data from valid voltage applied			2/ODR + 2 ms	-
Operating temperature range	T_{AGOC}		-40		85	°C

MMA8653FC

2.4 I²C interface characteristic

Table 6. I²C slave timing values ⁽¹⁾

Parameter	Symbol	I ² C Fast Mode		Unit
		Min	Max	
SCL clock frequency	f _{SCL}	0	400	kHz
Bus-free time between STOP and START condition	t _{BUF}	1.3		μs
(Repeated) START hold time	t _{HD;STA}	0.6		μs
Repeated START setup time	t _{SU;STA}	0.6		μs
STOP condition setup time	t _{SU;STO}	0.6		μs
SDA data hold time	t _{HD;DAT}	0.05	0.9 ⁽²⁾	μs
SDA setup time	t _{SU;DAT}	100		ns
SCL clock low time	t _{LOW}	1.3		μs
SCL clock high time	t _{HIGH}	0.6		μs
SDA and SCL rise time	t _r	20 + 0.1 C _b ⁽³⁾	300	ns
SDA and SCL fall time	t _f	20 + 0.1 C _b ⁽³⁾	300	ns
SDA valid time ⁽⁴⁾	t _{VD;DAT}		0.9 ⁽²⁾	μs
SDA valid acknowledge time ⁽⁵⁾	t _{VD;ACK}		0.9 ⁽²⁾	μs
Pulse width of spikes on SDA and SCL that must be suppressed by internal input filter	t _{SP}	0	50	ns
Capacitive load for each bus line	C _b		400	pF

1. All values referred to VIH(min) (0.3 VDD) and VIL(max) (0.7 VDD) levels.
2. This device does not stretch the LOW period (t_{LOW}) of the SCL signal.
3. C_b = total capacitance of one bus line in pF.
4. t_{VD;DAT} = time for data signal from SCL LOW to SDA output (HIGH or LOW, depending on which one is worse).
5. t_{VD;ACK} = time for Acknowledgement signal from SCL LOW to SDA output (HIGH or LOW, depending on which one is worse).

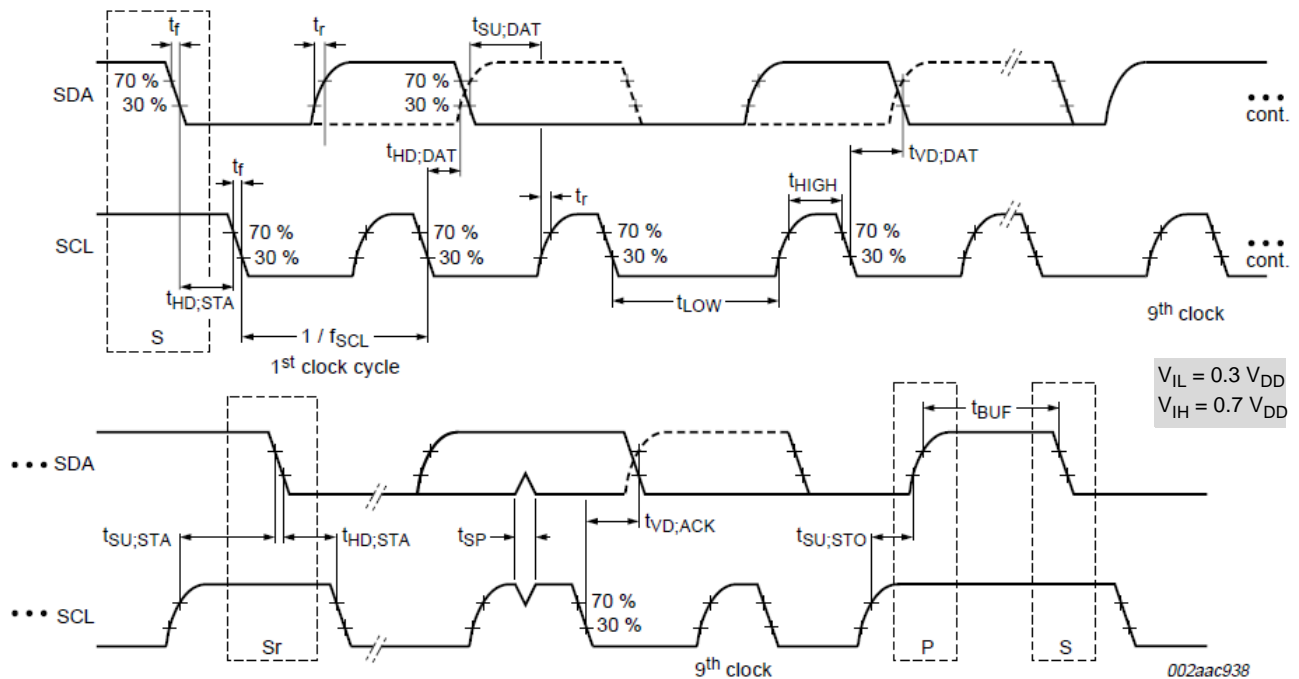

Figure 4. I²C slave timing diagram

MMA8653FC

3 Terminology

3.1 Sensitivity

The sensitivity is represented in counts/g.

- In ± 2 g mode, sensitivity = 256 counts/g.
- In ± 4 g mode, sensitivity = 128 counts/g.
- In ± 8 g mode, sensitivity = 64 counts/g.

3.2 Zero-g offset

Zero-g Offset (TyOff) describes the deviation of an actual output signal from the ideal output signal if the sensor is stationary. A sensor stationary on a horizontal surface will measure 0 g in X-axis and 0 g in Y-axis, whereas the Z-axis will measure 1 g. The output is ideally in the middle of the dynamic range of the sensor (content of OUT Registers 0x00, data expressed as a 2's complement number). A deviation from ideal value in this case is called Zero-g offset.

Offset is to some extent a result of stress on the MEMS sensor, and therefore the offset can slightly change after mounting the sensor onto a printed circuit board or after exposing it to extensive mechanical stress.

3.3 Self-Test

Self-Test can be used to verify the transducer and signal chain functionality without the need to apply external mechanical stimulus.

When Self-Test is activated:

- An electrostatic actuation force is applied to the sensor, simulating a small acceleration. In this case, the sensor outputs will exhibit a change in their DC levels which, are related to the selected full scale through the device sensitivity.
- The device output level is given by the algebraic sum of the signals produced by the acceleration acting on the sensor and by the electrostatic test-force.

4 Modes of Operation

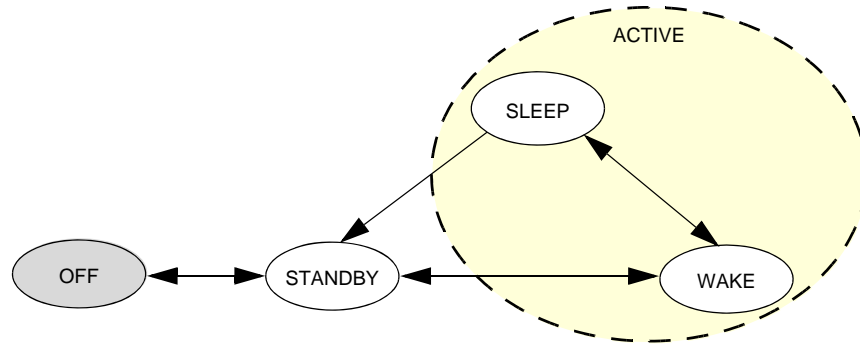

Figure 5. Operating modes for MMA8653FC

Table 7. Operating modes

Mode	I ² C Bus State	VDD	VDDIO	Description
OFF	Powered down	<1.8 V	VDDIO can be > VDD	<ul style="list-style-type: none"> The device is powered off. All analog and digital blocks are shutdown. I²C bus inhibited.
STANDBY	I ² C communication with MMA8653FC is possible	ON	VDDIO = High VDD = High ACTIVE bit is cleared	<ul style="list-style-type: none"> Only digital blocks are enabled. Analog subsystem is disabled. Internal clocks disabled.
ACTIVE (WAKE/SLEEP)	I ² C communication with MMA8653FC is possible	ON	VDDIO = High VDD = High ACTIVE bit is set	All blocks are enabled (digital, analog).

Some registers are reset when transitioning from STANDBY to ACTIVE. These registers are all noted in the device memory map register table.

The SLEEP and WAKE modes are ACTIVE modes. For more information about how to use the SLEEP and WAKE modes and how to transition between these modes, see [Section 5](#).

5 Functionality

The MMA8653FC is a low-power, digital output 3-axis linear accelerometer with a I²C interface with embedded logic used to detect events and notify an external microprocessor over interrupt lines.

- 8-bit or 10-bit data
- Four different oversampling options that allow for the optimum resolution vs. current consumption trade-off to be made for a given application
- Low-power and auto-WAKE/SLEEP modes for reducing current consumption
- Freefall detection (one channel)
- Single default angle for portrait landscape detection algorithm, for addressing screen orientation
- Two independent interrupt output pins that are programmable among four interrupt sources (Data Ready, Freefall, Orientation, Auto-WAKE)

All functionality is available in ± 2 g, ± 4 g or ± 8 g dynamic measurement ranges. There are many configuration settings for enabling all of the different functions. Separate application notes are available to help configure the device for each embedded functionality.

5.1 Device calibration

The device is factory calibrated for sensitivity and Zero-g offset for each axis. The trim values are stored in Non-Volatile Memory (NVM). On power-up, the trim parameters are read from NVM and applied to the circuitry. In normal use, further calibration in the end application is not necessary. However, the MMA8653FC allows you to adjust the offset for each axis after power-up, by changing the default offset values. The user offset adjustments are stored in three volatile 8-bit registers (OFF_X, OFF_Y, OFF_Z).

5.2 8-bit or 10-bit data

The measured acceleration data is stored in the following registers as 2's complement 10-bit numbers:

- OUT_X_MSB, OUT_X_LSB
- OUT_Y_MSB, OUT_Y_LSB
- OUT_Z_MSB, OUT_Z_LSB

The most significant eight bits of each axis are stored in OUT_X (Y, Z)_MSB, so applications needing only 8-bit results can use these three registers (and ignore the OUT_X/Y/Z_LSB registers). To use only 8-bit results, the F_READ bit in CTRL_REG1 must be set. When the F_READ bit is cleared, the fast read mode is disabled.

- **When the full-scale is set to ± 2 g**, the measurement range is -2 g to $+1.996$ g, and each count corresponds to $(1/256)$ g (3.8 mg) at 10-bit resolution.
- **When the full-scale is set to ± 4 g**, the measurement range is -4 g to $+3.992$ g, and each count corresponds to $(1/128)$ g (7.8 mg) at 10-bit resolution.
- **When the full-scale is set to ± 8 g**, the measurement range is -8 g to $+7.984$ g, and each count corresponds to $(1/64)$ g (15.6 mg) at 10-bit resolution.
- **If only the 8-bit results are used**, then the resolution is reduced by a factor of 16.

For more information about the data manipulation between data formats and modes, see application note AN4083, *Data Manipulation and Basic Settings for Xtrinsic MMA865xFC Accelerometers*. There is a device driver available that can be used with the Sensor Toolbox demo board (LFSTBEB865xFC) with this application note.

Table 8. Accelerometer 10-bit output data

10-bit Data	Range ± 2 g (3.9 mg/LSB)	Range ± 4 g (7.8 mg/LSB)	Range ± 8 g (15.6 mg/LSB)
01 1111 1111	1.996 g	+3.992 g	+7.984 g
01 1111 1110	1.992 g	+3.984 g	+7.968 g
...
00 0000 0001	0.003 g	+0.007 g	+0.015 g
00 0000 0000	0.000 g	0.000 g	0.000 g
11 1111 1111	-0.003 g	-0.007 g	-0.015 g
...
10 0000 0001	-1.961 g	-3.992 g	-7.984 g

MMA8653FC

Table 8. Accelerometer 10-bit output data (Continued)

10-bit Data	Range ± 2 g (3.9 mg/LSB)	Range ± 4 g (7.8 mg/LSB)	Range ± 8 g (15.6 mg/LSB)
10 0000 0000	-2.000 g	-4.000 g	-8.000 g
8-bit Data	Range ± 2 g (15.6 mg)	Range ± 4 g (31.25 mg)	Range ± 8 g (62.5 mg)
0111 1111	1.984 g	+3.968 g	+7.937 g
0111 1110	1.968 g	+3.937 g	+7.875 g
...
0000 0001	+0.015 g	+0.031 g	+0.062 g
0000 0000	0.000 g	0.000 g	0.000 g
1111 1111	-0.015 g	-0.031 g	-0.062 g
...
1000 0001	-1.984 g	-3.968 g	-7.937 g
1000 0000	-2.000 g	-4.000 g	-8.000 g

Table 9. Accelerometer 8-bit output data

8-bit Data	Range ± 2 g (15.6 mg/LSB)	Range ± 4 g (31.25 mg/LSB)	Range ± 8 g (62.5 mg/LSB)
0111 1111	1.9844 g	+3.9688 g	+7.9375 g
0111 1110	1.9688 g	+3.9375 g	+7.8750 g
...
0000 0001	+0.0156 g	+0.0313 g	+0.0625 g
0000 0000	0.000 g	0.0000 g	0.0000 g
1111 1111	-0.0156 g	-0.0313 g	-0.0625 g
...
1000 0001	-1.9844 g	-3.9688 g	-7.9375 g
1000 0000	-2.0000 g	-4.0000 g	-8.0000 g

5.3 Low power modes vs. high resolution modes

The MMA8653FC can be optimized for lower power modes or for higher resolution of the output data. One of the oversampling schemes of the data can be activated when MODS = 10 in Register 0x2B, which will improve the resolution of the output data only. The highest resolution is achieved at 1.56 Hz.

There is a trade-off between low power and high resolution. Low power can be achieved when the oversampling rate is reduced. When MODS = 11, the lowest power is achieved. The lowest power is achieved when the sample rate is set to 1.56 Hz.

5.4 Auto-WAKE/SLEEP mode

The MMA8653FC can be configured to transition between sample rates (with their respective current consumption) based on four of the interrupt functions of the device. The advantage of using the Auto-WAKE/SLEEP is that the system can automatically transition to a higher sample rate (higher current consumption) when needed, but spends the majority of the time in the SLEEP mode (lower current) when the device does not require higher sampling rates.

- **Auto-WAKE** refers to the device being triggered by one of the interrupt functions to transition to a higher sample rate. This may also interrupt the processor to transition from a SLEEP mode to a higher power mode.
- **SLEEP mode** occurs after the accelerometer has not detected an interrupt for longer than the user-definable timeout period. The device will transition to the specified lower sample rate. It may also alert the processor to go into a lower power mode, to save on current during this period of inactivity.

The Interrupts that can WAKE the device from SLEEP are Orientation detection and Freelfall detection. The interrupts that can keep the device from falling asleep are the same interrupts that can wake the device.

5.5 Freefall detection

MMA8653FC has an interrupt architecture for detecting a Freefall.

- Freefall can be enabled.
- Freefall is detected when the acceleration magnitude *is less than* the configured threshold.

The freefall configuration does not use a high-pass filter.

The detection of "Freefall" involves the monitoring of the X, Y, and Z axes for the condition where the acceleration magnitude is *below a user-specified threshold for a user-definable amount of time*. Usable threshold levels are typically between ± 100 mg and ± 500 mg.

5.6 Orientation detection

The MMA8653FC incorporates an advanced orientation detection algorithm with the ability to detect all six orientations shown in [Figure 6](#). The algorithm uses a single default trip point setting. The transition from portrait to landscape is fixed at 45° midpoint angle and $\pm 15^\circ$ hysteresis angle. This allows for smooth transitions from portrait to landscape at approximately 30° and landscape to portrait at approximately 60° ([Figure 7](#)).

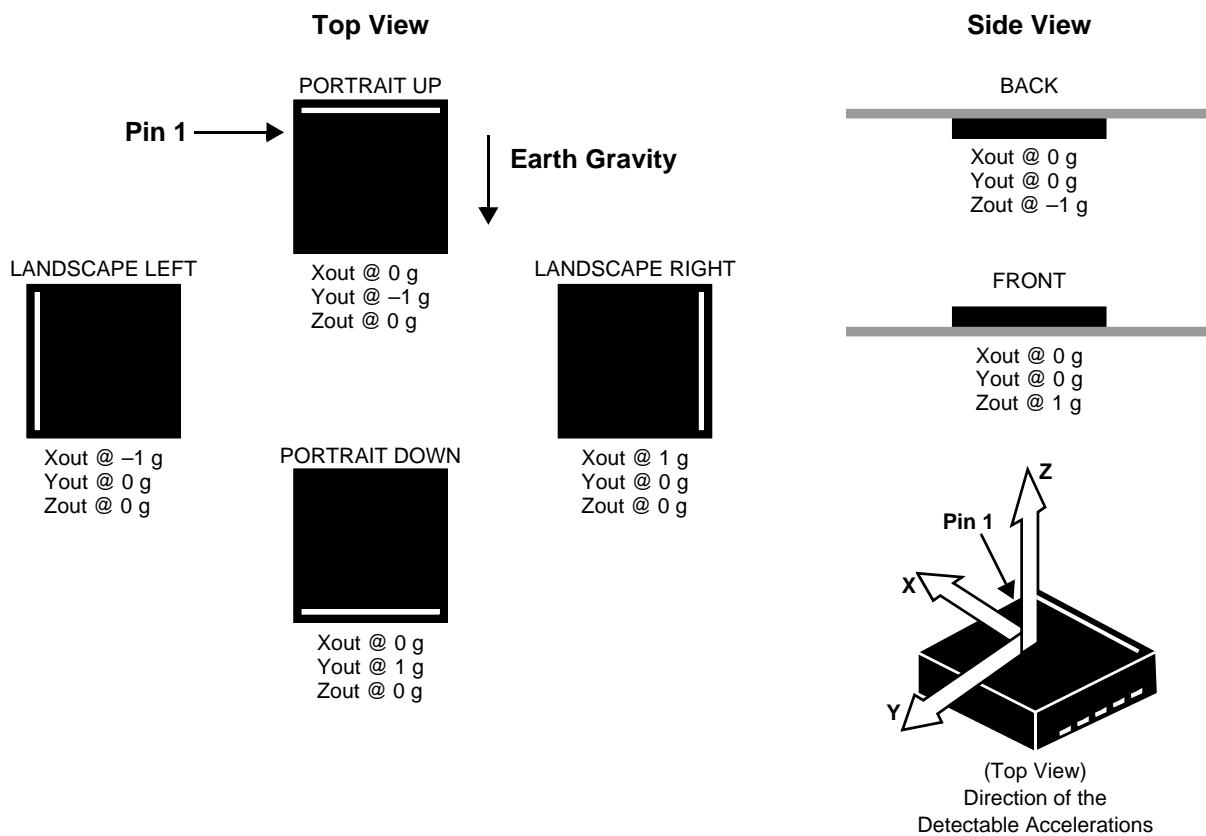

Figure 6. Sensitive axes orientation

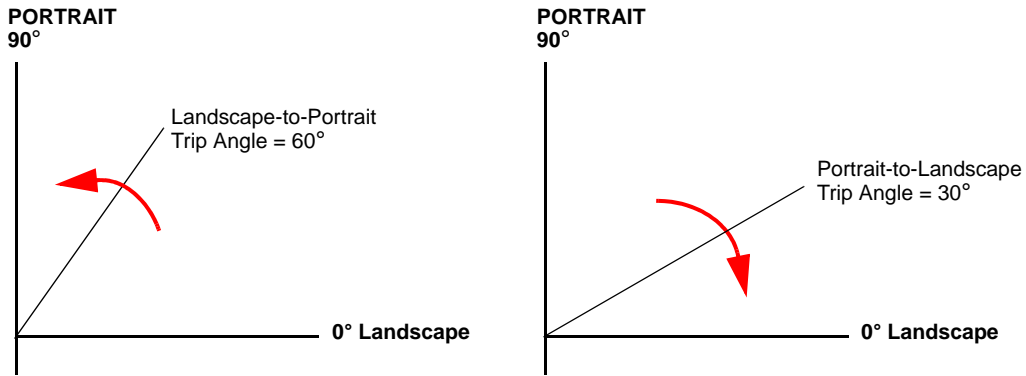

Figure 7. Landscape-to-Portrait transition trip angles

Based on the known functionality of linear accelerometers, when a device is oriented at a certain angle from flat and the device is rotating at slow angular speeds about the Z-axis, it is not possible to detect changes in acceleration. The angle at which the device no longer detects the orientation change is referred to as the "Z-lockout angle" (Figure 8).

The MMA8653FC orientation detection algorithm is configured to operate when the device is oriented at an angle of 29° or greater from flat ($Z_{out} = -1\text{ g}$ or $Z_{out} = 1\text{ g}$), with an accuracy of $\pm 2^\circ$.

When lifting the device upright from the flat position, orientation detection will be active for orientation angles greater than 29° from flat. This is the only setting available.

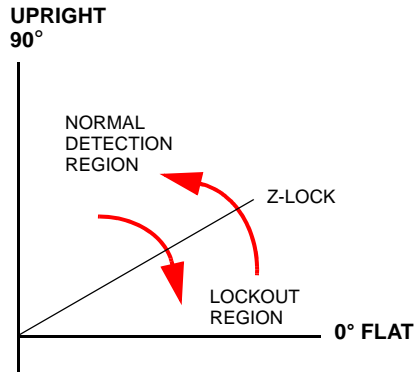

Figure 8. Z-Tilt angle lockout transition

5.7 Interrupt register configurations

There are four configurable interrupts in the MMA8653FC: Data Ready, Motion/Freefall, Orientation, and Auto-SLEEP events.

These four interrupt sources can be routed to one of two interrupt pins.

The interrupt source must be enabled and configured.

If the event flag is asserted because the event condition is detected, then the corresponding interrupt pin (INT1 or INT2) will assert.

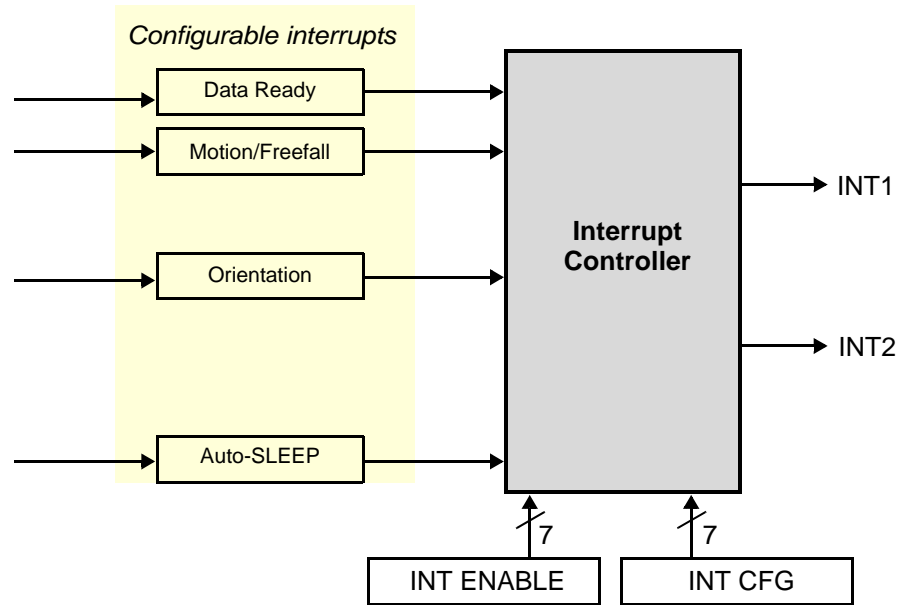

Figure 9. System interrupt generation

- The MMA8653FC features an interrupt signal that indicates when a new set of measured acceleration data is available, thus simplifying data synchronization in the digital system that uses the device.
- The MMA8653FC may also be configured to generate *other interrupt signals* accordingly, to the programmable embedded functions of the device for Motion, Freefall, and Orientation.

5.8 Serial I²C interface

Acceleration data may be accessed through an I²C interface, thus making the device particularly suitable for direct interfacing to a microcontroller. The acceleration data and configuration registers embedded inside the MMA8653FC are accessed through the I²C serial interface (Table 10).

- To enable the I²C interface, VDDIO line must be tied high (to the interface supply voltage). If VDD is not present and VDDIO is present, then the MMA8653FC is in OFF mode—and communications on the I²C interface are ignored.
- The I²C interface may be used for communications between other I²C devices; the MMA8653FC does not affect the I²C bus.

Table 10. Serial Interface pins

Pin Name	Pin Description	Notes
SCL	I ² C Serial Clock	<p>There are two signals associated with the I²C bus; the Serial Clock Line (SCL) and the Serial Data line (SDA).</p> <ul style="list-style-type: none"> • SDA is a bidirectional line used for sending and receiving the data to/from the interface. • External pullup resistors connected to VDDIO are expected for SDA and SCL. When the bus is free, both SCL and SDA lines are high.
SDA	I ² C Serial Data	

The I²C interface is compliant with Fast mode (400 kHz), and Normal mode (100 kHz) I²C standards (Table 11).

I²C operation:

1. The transaction on the bus is started through a start condition (START) signal. A START condition is defined as a high-to-low transition on the data line while the SCL line is held high. After START has been transmitted by the Master, the bus is considered busy.
2. The next byte of data transmitted after START contains the slave address in the first seven bits. The eighth bit tells whether the Master is *receiving data from the slave* or is *transmitting data to the slave*.
3. After a start condition and when an address is sent, each device in the system compares the first seven bits with its address. If the device's address matches the sent address, then the device considers itself addressed by the Master.

MMA8653FC

- The 9th clock pulse following the slave address byte (and each subsequent byte) is the acknowledge (ACK). The transmitter must release the SDA line during the ACK period. The receiver must then pull the data line low, so that it remains stable low during the high period of the acknowledge clock period.
- A Master may also issue a repeated START during a data transfer. The MMA8653FC expects repeated STARTs to be used to randomly read from specific registers.
- A low-to-high transition on the SDA line *while the SCL line is high* is defined as a stop condition (STOP). A data transfer is always terminated by a STOP.

The MMA8653FC's standard slave address is 0011101 or 0x01D. The slave addresses are factory programmed; alternate addresses are available upon request.

Table 11. I²C Device address sequence

Command	[6:0] Device address	[6:0] Device address	R/W	8-bit final value
Read	0011101	0x1D	1	0x3B
Write	0011101	0x1D	0	0x3A

5.8.1 Single-byte read

- The transmission of an 8-bit command begins on the falling edge of SCL. After the eight clock cycles are used to send the command, note that *the data returned* is sent with the MSB first after the data is received. Figure 10 shows the timing diagram for the accelerometer 8-bit I²C read operation.
- The Master (or MCU) transmits a start condition (ST) to the MMA8653FC [slave address (0x1D), with the R/W bit set to "0" for a write], and the MMA8653FC sends an acknowledgement.
- Next the Master (or MCU) transmits the address of the register to read, and the MMA8653FC sends an acknowledgement.
- The Master (or MCU) transmits a repeated start condition (SR) and then addresses the MMA8653FC (0x1D), with the R/W bit set to "1" for a read from the previously selected register.
- The Slave then acknowledges and transmits the data from the requested register. The Master does not acknowledge (NAK) the transmitted data, but transmits a stop condition to end the data transfer.

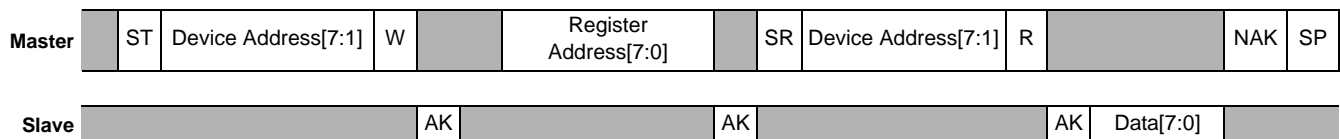

Figure 10. Single-Byte Read timing (I²C)

NOTE

For the following subsections, use the following legend.

Legend

ST: Start Condition SP: Stop Condition NAK: No Acknowledge W: Write = 0
 SR: Repeated Start Condition AK: Acknowledge R: Read = 1

5.8.2 Multiple byte read

(See Table 11 for next auto-increment address.)

- When performing a multi-byte read or "burst read", the MMA8653FC automatically increments the received register address commands after a read command is received.
- After following the steps of a single byte read, multiple bytes of data can be read from sequential registers after each MMA8653FC acknowledgment (AK) is received,
- Until a no acknowledge (NAK) occurs from the Master,
- Followed by a stop condition (SP), which signals the end of transmission.

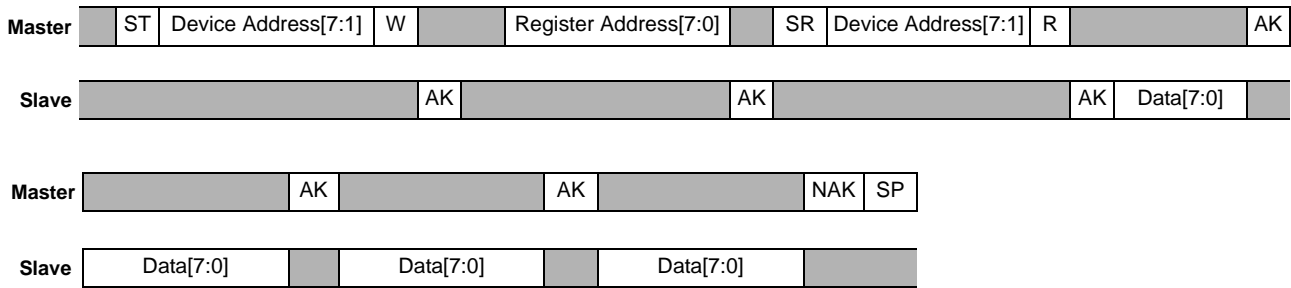

Figure 11. Multiple Byte Read timing (I²C)

5.8.3 Single byte write

1. To start a write command, the Master transmits a start condition (ST) to the MMA8653FC, slave address (\$1D) with the R/W bit set to “0” for a write,
2. The MMA8653FC sends an acknowledgement.
3. Next the Master (MCU) transmits the address of the register to write to, and the MMA8653FC sends an acknowledgement.
4. Then the Master (or MCU) transmits the 8-bit data to write to the designated register, and the MMA8653FC sends an acknowledgement that it has received the data. Because this transmission is complete, the Master transmits a stop condition (SP) to the data transfer. The data sent to the MMA8653FC is now stored in the appropriate register.

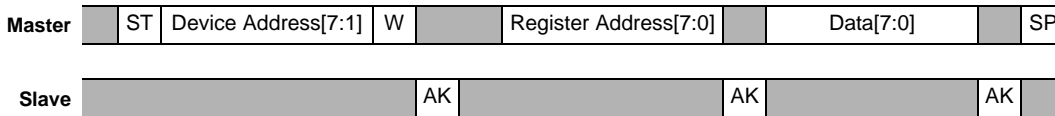

Figure 12. Single Byte Write timing (I²C)

5.8.4 Multiple byte write

(See Table 11 for next auto-increment address.)

1. After a write command is received, the MMA8653FC *automatically increments* the received register address commands.
2. Therefore, after following the steps of a single byte write, multiple bytes of data can be written to sequential registers after each MMA8653FC acknowledgement (ACK) is received.

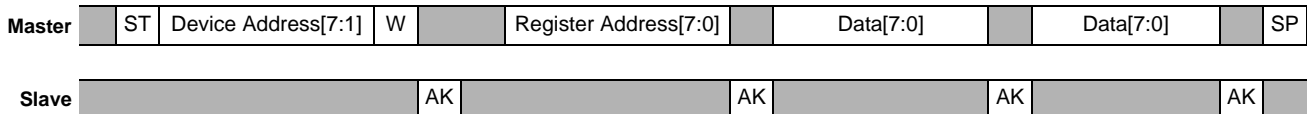

Figure 13. Multiple Byte Write timing (I²C)

6 Register Descriptions

6.1 Register address map

Table 12. MMA8653FC register address map

Field	Type	Register Address	Auto-Increment Address		Default	Hex Value	Comment
			F_READ = 0	F_READ = 1			
STATUS ^{(1),(2)}	R	0x00	0x01		00000000	0x00	Real time status
OUT_X_MSB ⁽¹⁾	R	0x01	0x02	0x03	Output	—	[7:0] are 8 MSBs of 10-bit sample.
OUT_X_LSB ⁽¹⁾	R	0x02	0x03	0x00	Output	—	[7:6] are 2 LSBs of 10-bit real-time sample
OUT_Y_MSB ⁽¹⁾	R	0x03	0x04	0x05	Output	—	[7:0] are 8 MSBs of 10-bit real-time sample
OUT_Y_LSB ⁽¹⁾	R	0x04	0x05	0x00	Output	—	[7:6] are 2 LSBs of 10-bit real-time sample
OUT_Z_MSB ⁽¹⁾	R	0x05	0x06	0x00	Output	—	[7:0] are 8 MSBs of 10-bit real-time sample
OUT_Z_LSB ⁽¹⁾	R	0x06	0x00		Output	—	[7:6] are 2 LSBs of 10-bit real-time sample
Reserved	R	0x07–0x0A	—		00000000	0x00	Reserved. Read return 0x00.
SYSMOD	R	0x0B	0x0C		00000000	0x00	Current System Mode
INT_SOURCE ^{(1),(2)}	R	0x0C	0x0D		00000000	0x00	Interrupt status
WHO_AM_I ⁽³⁾	R	0x0D	0x0E		01001010	0x5A	Device ID (0x5A)
XYZ_DATA_CFG ^{(3),(4)}	R/W	0x0E	0x0F		00000000	0x00	Dynamic Range Settings
Reserved	R	0x0F	—		00000000	0x00	Reserved. Read return 0x00.
PL_STATUS ^{(1),(2)}	R	0x10	0x11		00000000	0x00	Landscape/Portrait orientation status
PL_CFG ^{(3),(4)}	R/W	0x11	0x12		10000000	0x80	Landscape/Portrait configuration.
PL_COUNT ^{(3),(4)}	R/W	0x12	0x13		00000000	0x00	Landscape/Portrait debounce counter
PL_BF_ZCOMP ⁽³⁾	R	0x13	0x14		01000100	0x44	Back/Front, Z-Lock Trip threshold
PL_THS_REG ⁽³⁾	R	0x14	0x15		10000100	0x84	Portrait to Landscape Trip angle
FF_MT_CFG ^{(3),(4)}	R/W	0x15	0x16		00000000	0x00	Freefall/Motion functional block configuration
FF_MT_SRC ^{(1),(2)}	R	0x16	0x17		00000000	0x00	Freefall/Motion event source register
FF_MT_THS ^{(3),(4)}	R/W	0x17	0x18		00000000	0x00	Freefall/Motion threshold register
FF_MT_COUNT ^{(3),(4)}	R/W	0x18	0x19		00000000	0x00	Freefall/Motion debounce counter
Reserved	R	0x19–0x28	—		00000000	0x00	Reserved. Read return 0x00.
ASLP_COUNT ^{(3),(4)}	R/W	0x29	0x2A		00000000	0x00	Counter setting for Auto-SLEEP/WAKE
CTRL_REG1 ^{(3),(4)}	R/W	0x2A	0x2B		00000000	0x00	Data Rates, ACTIVE Mode.
CTRL_REG2 ^{(3),(4)}	R/W	0x2B	0x2C		00000000	0x00	Sleep Enable, OS Modes, RST, ST
CTRL_REG3 ^{(3),(4)}	R/W	0x2C	0x2D		00000000	0x00	Wake from Sleep, IPOL, PP_OD
CTRL_REG4 ^{(3),(4)}	R/W	0x2D	0x2E		00000000	0x00	Interrupt enable register
CTRL_REG5 ^{(3),(4)}	R/W	0x2E	0x2F		00000000	0x00	Interrupt pin (INT1/INT2) map
OFF_X ^{(3),(4)}	R/W	0x2F	0x30		00000000	0x00	X-axis offset adjust
OFF_Y ^{(3),(4)}	R/W	0x30	0x31		00000000	0x00	Y-axis offset adjust
OFF_Z ^{(3),(4)}	R/W	0x31	0x0D		00000000	0x00	Z-axis offset adjust

1. The register data is only valid in ACTIVE mode.

2. Register contents are reset when transition from STANDBY to ACTIVE mode occurs.

3. Register contents are preserved when transition from ACTIVE to STANDBY mode occurs.

4. Modification of this register's content can only occur when device is in STANDBY mode, except CTRL_REG1 ACTIVE bit and CTRL_REG2 RST bit.

6.2 Register bit map

Table 13. MMA8653FC register bit map

Reg	Field	Definition	Type	Bit 7	Bit 6	Bit 5	Bit 4	Bit 3	Bit 2	Bit 1	Bit 0
00	STATUS	Data Status	R	ZYXOW	ZOW	YOW	XOW	ZYXDR	ZDR	YDR	XDR
01	OUT_X_MSB	10-bit X Data	R	XD9	XD8	XD7	XD6	XD5	XD4	XD3	XD2
02	OUT_X_LSB	10-bit X Data	R	XD1	XD0	0	0	0	0	0	0
03	OUT_Y_MSB	10-bit Y Data	R	YD9	YD8	YD7	YD6	YD5	YD4	YD3	YD2
04	OUT_Y_LSB	10-bit Y Data	R	YD1	YD0	0	0	0	0	0	0
05	OUT_Z_MSB	10-bit Z Data	R	ZD9	ZD8	ZD7	ZD6	ZD5	ZD4	ZD3	ZD2
06	OUT_Z_LSB	10-bit Z Data	R	ZD1	ZD0	0	0	0	0	0	0
07-0A	Reserved	—	R	0	0	0	0	0	0	0	0
0B	SYSMOD	System Mode	R	0	0	0	0	0	0	SYSMOD1	SYSMOD0
0C	INT_SOURCE	Interrupt Status	R	SRC_ASLP	0	0	SRC_LNDPRT	0	SRC_FF_MT	0	SRC_DRDY
0D	WHO_AM_I	ID Register	R	0	1	0	1	1	0	1	0
0E	XYZ_DATA_CFG	Data Config	R/W	0	0	0	0	0	0	FS1	FS0
0F	Reserved	—	R	—	—	—	—	—	—	—	—
10	PL_STATUS	Portrait Landscape Status	R	NEWLP	LO	0	0	0	LAPO[1]	LAPO[0]	BAFRO
11	PL_CFG	Portrait Landscape Configuration	R/W	DBCNTM	PL_EN	0	0	0	0	0	0
12	PL_COUNT	Portrait Landscape Debounce	R/W	DBNCE[7]	DBNCE[6]	DBNCE[5]	DBNCE[4]	DBNCE[3]	DBNCE[2]	DBNCE[1]	DBNCE[0]
13	PL_BF_ZCOMP	Portrait Landscape Back/Front Z Comp	R	0	1	0	0	0	1	0	0
14	PL_THS_REG	Portrait Landscape Threshold	R	1	0	0	0	0	1	0	0
15	FF_MT_CFG	Freefall/Motion Config	R/W	ELE	OAE	ZEFE	YEFE	XEFE	0	0	0
16	FF_MT_SRC	Freefall/Motion Status	R	EA	0	ZHE	ZHP	YHE	YHP	XHE	XHP
17	FF_MT_THS	Freefall/Motion Threshold	R/W	DBCNTM	THS6	THS5	THS4	THS3	THS2	THS1	THS0
18	FF_MT_COUNT	Freefall/Motion Debounce	R/W	D7	D6	D5	D4	D3	D2	D1	D0
19-28	Reserved	—	R	—	—	—	—	—	—	—	—
29	ASLP_Count	Counter setting for Auto-SLEEP/WAKE	R/W	D7	D6	D5	D4	D3	D2	D1	D0
2A	CTRL_REG1	Control Reg1	R/W	ASLP_RATE1	ASLP_RATE0	DR2	DR1	DR0	0	F_READ	ACTIVE
2B	CTRL_REG2	Control Reg2	R/W	ST	RST	—	SMODS1	SMODS0	SLPE	MODS1	MODS0
2C	CTRL_REG3	Control Reg3	R/W	—	—	WAKE_LNDPRT	—	WAKE_FF_MT	0	IPOL	PP_OD
2D	CTRL_REG4	Control Reg4	R/W	INT_EN_ASLP	—	—	INT_EN_LNDPRT	—	INT_EN_FF_MT	0	INT_EN_DRDY
2E	CTRL_REG5	Control Reg5	R/W	INT_CFG_ASLP	—	—	INT_CFG_LNDPRT	—	INT_CFG_FF_MT	0	INT_CFG_DRDY
2F	OFF_X	X 8-bit offset	R/W	D7	D6	D5	D4	D3	D2	D1	D0
30	OFF_Y	Y 8-bit offset	R/W	D7	D6	D5	D4	D3	D2	D1	D0
31	OFF_Z	Z 8-bit offset	R/W	D7	D6	D5	D4	D3	D2	D1	D0

Note: Bits showing “—” can read as either 0 or 1, and these bits have no definition.

6.3 Data registers

The following are the data registers for the MMA8653FC device. For more information about data manipulation in the MMA8653FC, see application note AN4083, *Data Manipulation and Basic Settings for Xtrinsic MMA865xFC Accelerometers*.

- When accessing the 8-bit data, the F_READ bit (register 0x2A) is set, which modifies the auto-incrementing to skip over the LSB data.
- When the F_READ bit is cleared, the 12-bit data is read, accessing all 6 bytes sequentially (X_MSB, X_LSB, Y_MSB, Y_LSB, Z_MSB, Z_LSB).

6.3.1 0x00: STATUS Data Status register

Data Status register 0x00 reflects the real-time status information of the X, Y and Z sample data; it contains the X, Y, and Z data overwrite and data ready flag.

These registers contain the X-axis, Y-axis, and Z-axis 12-bit output sample data (expressed as 2's complement numbers).

Table 14. 0x00 STATUS: Data Status register (Read-Only)

Back to Register Address Map

Bit 7	Bit 6	Bit 5	Bit 4	Bit 3	Bit 2	Bit 1	Bit 0
ZYXOW	ZOW	YOW	XOW	ZYXDR	ZDR	YDR	XDR

Table 15. STATUS register bits

Bit(s)	Field	Description	Notes
7	ZYXOW	X, Y, Z-axis data overwrite <ul style="list-style-type: none"> • Set whenever a new acceleration data is produced <i>before completing the retrieval of the previous set</i>. This event occurs when the content of at least one acceleration data register (i.e., OUT_X, OUT_Y, OUT_Z) has been overwritten. • Cleared when the high bytes of the acceleration data (OUT_X_MSB, OUT_Y_MSB, OUT_Z_MSB) of all the channels are read. 0 No data overwrite has occurred (default) 1 Previous X, Y, or Z data was overwritten by new X, Y, or Z data before it (the previous X, Y, or Z data) was read	
6	ZOW	Z-axis data overwrite	For # = Z, Y, or X: <ul style="list-style-type: none"> • Set whenever a new acceleration sample <i>related to the #-axis</i> is generated <i>before the retrieval of the previous sample</i>. When this occurs, the previous sample is overwritten. • Cleared whenever the OUT_#_MSB register is read. 0 No data overwrite has occurred (default) 1 Previous Z-axis data was overwritten by new #-axis data before it (the previous #-axis data) was read
5	YOW	Y-axis data overwrite	
4	XOW	X-axis data overwrite	
3	ZYXDR	X, Y, Z-axis new data ready <ul style="list-style-type: none"> • Set when a new sample for any of the enabled channels is available. • Cleared when the high-bytes of the acceleration data (OUT_X_MSB, OUT_Y_MSB, OUT_Z_MSB) of all the channels are read. 0 No new set of data ready (default) 1 A new set of data is ready	
2	ZDR	Z-axis new data available	For # = Z, Y, or X <ul style="list-style-type: none"> • Set whenever a new acceleration sample <i>related to the #-axis</i> is generated. • Cleared whenever the OUT_#_MSB register is read. 0 No new #-axis data ready (default) 1 New #-axis data is ready
1	YDR	Y-axis new data available	
0	XDR	X-axis new data available	

Table 16. 0x01 OUT_X_MSB: X_MSB register (Read-Only)

Back to Register Address Map

Bit 7	Bit 6	Bit 5	Bit 4	Bit 3	Bit 2	Bit 1	Bit 0
XD9	XD8	XD7	XD6	XD5	XD4	XD3	XD2

Table 17. 0x02 OUT_X_LSB: X_LSB register (Read-Only)

Back to Register Address Map

Bit 7	Bit 6	Bit 5	Bit 4	Bit 3	Bit 2	Bit 1	Bit 0
XD1	XD0	0	0	0	0	0	0

MMA8653FC

Table 18. 0x03 OUT_Y_MSB: Y_MSB register (Read-Only)*Back to Register Address Map*

Bit 7	Bit 6	Bit 5	Bit 4	Bit 3	Bit 2	Bit 1	Bit 0
YD9	YD8	YD7	YD6	YD5	YD4	YD3	YD2

Table 19. 0x04 OUT_Y_LSB: Y_LSB register (Read-Only)*Back to Register Address Map*

Bit 7	Bit 6	Bit 5	Bit 4	Bit 3	Bit 2	Bit 1	Bit 0
YD1	YD0	0	0	0	0	0	0

Table 20. 0x05 OUT_Z_MSB: Z_MSB register (Read-Only)*Back to Register Address Map*

Bit 7	Bit 6	Bit 5	Bit 4	Bit 3	Bit 2	Bit 1	Bit 0
ZD9	ZD8	ZD7	ZD6	ZD5	ZD4	ZD3	ZD2

Table 21. 0x06 OUT_Z_LSB: Z_LSB register (Read-Only)*Back to Register Address Map*

Bit 7	Bit 6	Bit 5	Bit 4	Bit 3	Bit 2	Bit 1	Bit 0
ZD1	ZD0	0	0	0	0	0	0

- OUT_X_MSB, OUT_X_LSB, OUT_Y_MSB, OUT_Y_LSB, OUT_Z_MSB, and OUT_Z_LSB are stored in the auto-incrementing address range of 0x01 – 0x06, to reduce reading the status followed by 10-bit axis data to 7 bytes. If the F_READ bit is set (0x2A bit 1), then auto-increment will skip over LSB registers (to access the MSB data only). This will shorten the data acquisition from seven bytes to four bytes.
- The LSB registers can only be read immediately following the read access of the corresponding MSB register.
 - A random read access to the LSB registers is not possible.
 - *Reading the MSB register and then the LSB register in sequence* ensures that both bytes (LSB and MSB) belong to the same data sample, even if a new data sample arrives between reading the MSB and the LSB byte.

6.4 System status and ID registers

6.4.1 0x0B: SYSMOD System Mode register

The System mode register indicates the current device operating mode. Applications using the Auto-SLEEP/WAKE mechanism should use the SYSMOD register to synchronize the application with the device operating mode transitions.

Table 22. 0x0B SYSMOD: System Mode register (Read-Only)

Back to Register Address Map

Bit 7	Bit 6	Bit 5	Bit 4	Bit 3	Bit 2	Bit 1	Bit 0
0	0	0	0	0	0	SYSMOD1	SYSMOD0

Table 23. SYSMOD register

Bit(s)	Field	Description
7–2	0	Reserved
1–0	SYSMOD[1:0]	System Mode 00 STANDBY mode (default) 01 WAKE mode 10 SLEEP mode

6.4.2 0x0C: INT_SOURCE System Interrupt Status register

In the interrupt source register, the status of the various embedded features can be determined.

- The bits that are set (logic '1') indicate which function has asserted an interrupt.
- The bits that are cleared (logic '0') indicate which function has not asserted (or has deasserted) an interrupt.

INT_SOURCE register bits are set by a low-to-high transition, and are cleared by reading the appropriate interrupt source register. For example, the SRC_DRDY bit is cleared when the ZYXDR bit (STATUS register) is cleared, but the SRC_DRDY bit is not cleared by simply reading the STATUS register (0x00), but is cleared by reading all the X, Y, and Z MSB data.

Table 24. 0x0C INT_SOURCE: System Interrupt Status register (Read Only)

Back to Register Address Map

Bit 7	Bit 6	Bit 5	Bit 4	Bit 3	Bit 2	Bit 1	Bit 0
SRC_ASLP	0	0	SRC_LNDPRT	0	SRC_FF_MT	0	SRC_DRDY

Table 25. INT_SOURCE register

Bit(s)	Field	Description
7	SRC_ASLP	Auto-SLEEP/WAKE interrupt status bit <ul style="list-style-type: none"> • WAKE-to-SLEEP transition occurs when no interrupt occurs for a time period that exceeds the user-specified limit (ASLP_COUNT). This causes the system to transition to a user-specified low ODR setting. • SLEEP-to-WAKE transition occurs when the user-specified interrupt event has woken the system; thus causing the system to transition to a user-specified high ODR setting. • Reading the SYSMOD register clears the SRC_ASLP bit. 1 An interrupt event <i>that can cause a WAKE-to-SLEEP or SLEEP-to-WAKE system mode transition</i> has occurred. 0 No WAKE-to-SLEEP or SLEEP-to-WAKE system mode transition interrupt event has occurred. (default)
6	0	
5	0	
4	SRC_LNDPRT	Landscape/Portrait Orientation interrupt status bit <ul style="list-style-type: none"> • SRC_LNDPRT bit is asserted whenever the NEWLP bit (PL_STATUS register) is asserted and the interrupt has been enabled. • SRC_LNDPRT bit is cleared by reading the PL_STATUS register. 1 An interrupt was generated due to a change in the device orientation status. 0 No change in orientation status was detected. (default)
3	0	
2	SRC_FF_MT	Freefall/Motion interrupt status bit <ul style="list-style-type: none"> • SRC_FF_MT bit is asserted whenever the EA bit (FF_MT_SRC register) is asserted and the FF_MT interrupt has been enabled. • SRC_FF_MT bit is cleared by reading the FF_MT_SRC register. 1 The Freefall/Motion function interrupt is active. 0 No Freefall or Motion event was detected. (default)
1	0	
0	SRC_DRDY	Data Ready Interrupt bit status bit <ul style="list-style-type: none"> • SRC_DRDY bit is asserted when the ZYXOW and/or ZYXDR bit is set and the interrupt has been enabled. • SRC_DRDY bit is cleared by reading the X, Y, and Z data. 1 The X, Y, Z data ready interrupt is active (indicating the presence of new data and/or data overrun). 0 The X, Y, Z interrupt is not active. (default)

6.4.3 0x0D: WHO_AM_I Device ID register

The device identification register identifies the part. The default value is 0x5A (for MMA8653FC).

This value is programmed by Freescale before the part leaves the factory. For custom alternate values, contact Freescale.

Table 26. 0x0D: WHO_AM_I Device ID register (Read-Only)*Back to Register Address Map*

Bit 7	Bit 6	Bit 5	Bit 4	Bit 3	Bit 2	Bit 1	Bit 0
0	1	0	1	1	0	1	0

6.5 Data configuration registers

6.5.1 0x0E: XYZ_DATA_CFG register

The XYZ_DATA_CFG register sets the dynamic range.

Table 27. 0x0E: XYZ_DATA_CFG register (Read/Write)

Back to Register Address Map

Bit 7	Bit 6	Bit 5	Bit 4	Bit 3	Bit 2	Bit 1	Bit 0
0	0	0	0	0	0	FS1	FS0

Table 28. XYZ Data Configuration register

Bit(s)	Field	Description	
7-2	0		
1-0	FS[1:0]	Output buffer data format using full scale 00 ±2 g (default)	The default full scale value range is ±2 g.

Table 29. Full-Scale Range

FS1	FS0	Full-Scale Range
0	0	±2 g
0	1	±4 g
1	0	±8 g
1	1	Reserved

6.6 Portrait/Landscape configuration and status registers

For more information about the different user-configurable settings and example code, see application note AN4083, *Data Manipulation and Basic Settings for Xtrinsic MMA865xFC Accelerometers*.

6.6.1 0x10: PL_STATUS Portrait/Landscape Status register

To get updated information on any change in orientation, read the Portrait/Landscape Status register (read Bit 7, or read the other bits for more orientation data). For more about Portrait Up, Portrait Down, Landscape Left, Landscape Right, Back, and Front orientations, see [Figure 6](#). The interrupt is cleared when reading the PL_STATUS register.

Table 30. 0x10 PL_STATUS Register (Read-Only)

Back to Register Address Map

Bit 7	Bit 6	Bit 5	Bit 4	Bit 3	Bit 2	Bit 1	Bit 0
NEWLP	LO	0	0	0	LAPO[1]	LAPO[0]	BAFRO

Table 31. PL_STATUS register

Bit(s)	Field	Description
7	NEWLP	Landscape/Portrait status change flag <ul style="list-style-type: none"> NEWLP is set to 1 after the first orientation detection after a STANDBY-to-ACTIVE transition, and whenever a change in LO, BAFRO, or LAPO occurs. NEWLP bit is cleared anytime PL_STATUS register is read. 0 No change (default) 1 BAFRO and/or LAPO and/or Z-Tilt lockout value has changed
6	LO	Z-Tilt Angle Lockout <ul style="list-style-type: none"> 0 Lockout condition has not been detected (default) 1 Z-Tilt lockout trip angle has been exceeded. Lockout has been detected.
5–3	0	
2–1	LAPO[1:0] ⁽¹⁾	Landscape/Portrait orientation <ul style="list-style-type: none"> 00 Portrait Up: Equipment standing vertically in the normal orientation (default) 01 Portrait Down: Equipment standing vertically in the inverted orientation 10 Landscape Right: Equipment is in landscape mode to the right 11 Landscape Left: Equipment is in landscape mode to the left.
0	BAFRO	Back or Front orientation <ul style="list-style-type: none"> 0 Front: Equipment is in the front-facing orientation (default) 1 Back: Equipment is in the back-facing orientation

1. The default power-up state is BAFRO = 0, LAPO = 00, and LO = 0.

- The orientation mechanism state change is limited to a maximum 1.25 g. The current position is locked if the absolute value of the acceleration experienced on any of the three axes is greater than 1.25 g.
- LAPO, BAFRO, and LO continue to change when NEWLP is set.

6.6.2 0x11 Portrait/Landscape Configuration register

The Portrait/Landscape Configuration register enables the portrait/landscape function and sets the behavior of the debounce counter.

Table 32. 0x11 PL_CFG register (Read/Write)

Back to Register Address Map

Bit 7	Bit 6	Bit 5	Bit 4	Bit 3	Bit 2	Bit 1	Bit 0
DBCNTM	PL_EN	0	0	0	0	0	0

Table 33. PL_CFG register

Bit(s)	Field	Description
7	DBCNTM	Debounce counter mode selection 0 Decrements debounce whenever the condition of interest is no longer valid. 1 Clears the counter whenever the condition of interest is no longer valid. (default)
6	PL_EN	Portrait/Landscape detection enable 0 Portrait/Landscape Detection is disabled. (default) 1 Portrait/Landscape Detection is enabled.
5-0	0	

6.6.3 0x12 Portrait/Landscape Debounce register

The Portrait/Landscape Debounce register sets the debounce count for the orientation state transition. The minimum debounce latency is determined by the data rate (which is set by the product of the selected system ODR and PL_COUNT registers). Any transition from WAKE to SLEEP (or SLEEP to Wake) resets the internal Landscape/Portrait debounce counter.

NOTE

The debounce counter weighting (time step) changes, based on the ODR and the Oversampling mode. [Table 40](#) explains the time step value for all sample rates and all Oversampling modes.

Table 34. 0x12 PL_COUNT register (Read/Write)

Back to Register Address Map

Bit 7	Bit 6	Bit 5	Bit 4	Bit 3	Bit 2	Bit 1	Bit 0
DBNCE[7]	DBNCE[6]	DBNCE[5]	DBNCE[4]	DBNCE[3]	DBNCE[2]	DBNCE[1]	DBNCE[0]

Table 35. PL_COUNT register

Bit(s)	Field	Description
7-0	DBCNE[7:0]	Debounce Count value 0000_0000 (default)

Table 36. PL_COUNT relationship with the ODR

ODR (Hz)	Max Time Range (s)				Time Step (ms)			
	Normal	LPLN	HighRes	LP	Normal	LPLN	HighRes	LP
800	0.319	0.319	0.319	0.319	1.25	1.25	1.25	1.25
400	0.638	0.638	0.638	0.638	2.5	2.5	2.5	2.5
200	1.28	1.28	0.638	1.28	5	5	2.5	5
100	2.55	2.55	0.638	2.55	10	10	2.5	10
50	5.1	5.1	0.638	5.1	20	20	2.5	20
12.5	5.1	20.4	0.638	20.4	20	80	2.5	80
6.25	5.1	20.4	0.638	40.8	20	80	2.5	160
1.56	5.1	20.4	0.638	40.8	20	80	2.5	160

6.6.4 0x13: PL_BF_ZCOMP Back/Front and Z Compensation register

The Z-Lock angle compensation bits fix the Z-lockout angle to 30° upon power up. The Back to Front trip angle is fixed to $\pm 75^\circ$.

Table 37. 0x13: PL_BF_ZCOMP register (Read only)*Back to Register Address Map*

Bit 7	Bit 6	Bit 5	Bit 4	Bit 3	Bit 2	Bit 1	Bit 0
0	1	0	0	0	1	0	0

Table 38. PL_BF_ZCOMP register

Bit(s)	Field	Description	Notes
7-0	0100 0100		

6.6.5 0x14: P_L_THS_REG Portrait/Landscape Threshold and Hysteresis register

This register represents the Portrait-to-Landscape trip threshold register used to set the trip angle for transitioning from Portrait to Landscape mode and from Landscape to Portrait mode. This register includes a value for the hysteresis.

Table 39. 0x14: P_L_THS_REG register (Read only)*Back to Register Address Map*

Bit 7	Bit 6	Bit 5	Bit 4	Bit 3	Bit 2	Bit 1	Bit 0
1	0	0	0	0	1	0	0

Table 40. P_L_THS_REG register

Bit(s)	Field	Description	Notes
7-0	1000 0100		

6.7 Freefall/Motion configuration and status registers

The freefall/motion function can be configured in either Freefall or Motion Detection mode via the **OAE** configuration bit (0x15: FF_MTG_CFG, bit 6). The freefall/motion detection block can be disabled by setting all three bits (ZEFE, YEFE, XEFE) to zero.

Depending on the register bits **ELE** (0x15: FF_MTG_CFG, bit 7) and **OAE** (0x15: FF_MTG_CFG, bit 6), each of the freefall and motion detection block can operate in four different modes.

6.7.1 Motion and freefall modes

6.7.1.1 Mode 1: Freefall detection with ELE = 0, OAE = 0

In this mode, the **EA** bit (0x16: FF_MTG_CFG, bit 7) indicates a freefall event after the debounce counter is complete. The ZEFE, YEFE, and XEFE control bits determine which axes are considered for the freefall detection. Once the EA bit is set, and DBCNTM = 0, the EA bit can get cleared only after the delay specified by FF_MT_COUNT. This is because the counter is in decrement mode. If DBCNTM = 1, then the EA bit is cleared as soon as the freefall condition disappears, and will not be set again before the delay specified by FF_MT_COUNT has passed. Reading the FF_MT_SRC register does not clear the EA bit.

The event flags (0x16) ZHE, ZHP, YHE, YHP, XHE, and XHP reflect the motion detection status (i.e., a high g event) without any debouncing, provided that the corresponding bits ZEFE, YEFE, and/or XEFE are set.

6.7.1.2 Mode 2: Freefall detection with ELE = 1, OAE = 0

In this mode, the **EA** event bit indicates a freefall event after the debounce counter. Once the debounce counter reaches the time value for the set threshold, the EA bit is set, and the EA bit remains set until the FF_MT_SRC register is read. When the FF_MT_SRC register is read, the EA bit and the debounce counter are cleared, and a new event can only be generated after the delay specified by FF_MT_CNT. The ZEFE, YEFE, and XEFE control bits determine which axes are considered for the freefall detection. While EA = 0, the event flags ZHE, ZHP, YHE, YHP, XHE, and XHP reflect the motion detection status (i.e., a high g event) without any debouncing, provided that the corresponding bits ZEFE, YEFE, and/or XEFE are set.

The event flags ZHE, ZHP, YHE, YHP, XHE, and XHP are latched when the EA event bit is set. The event flags ZHE, ZHP, YHE, YHP, XHE, and XHP will start changing only after the FF_MT_SRC register has been read.

6.7.1.3 Mode 3: Motion detection with ELE = 0, OAE = 1

In this mode, the EA bit indicates a motion event after the debounce counter time is reached. The ZEFE, YEFE, and XEFE control bits determine which axes are taken into consideration for motion detection. Once the EA bit is set and if DBCNTM = 0, the EA bit can get cleared only after the delay specified by FF_MT_COUNT. If DBCNTM = 1, then the EA bit is cleared as soon as the motion high g condition disappears.

The event flags ZHE, ZHP, YHE, YHP, XHE, and XHP reflect the motion detection status (i.e., a high g event) without any debouncing, provided that the corresponding bits ZEFE, YEFE, and/or XEFE are set. Reading the FF_MT_SRC does not clear any flags, nor is the debounce counter reset.

6.7.1.4 Mode 4: Motion detection with ELE = 1, OAE = 1

In this mode, the EA bit indicates a motion event after debouncing. The ZEFE, YEFE, and XEFE control bits determine which axes are taken into consideration for motion detection. Once the debounce counter reaches the threshold, the EA bit is set, and the EA bit remains set until the FF_MT_SRC register is read. When the FF_MT_SRC register is read, all register bits are cleared and the debounce counter are cleared and a new event can only be generated after the delay specified by FF_MT_CNT.

While the bit EA is zero, the event flags ZHE, ZHP, YHE, YHP, XHE, and XHP reflect the motion detection status (i.e., a high g event) without any debouncing, provided that the corresponding bits ZEFE, YEFE, and/or XEFE are set. When the EA bit is set, these bits (ZHE, ZHP, YHE, YHP, XHE, XHP) keep their current value until the FF_MT_SRC register is read.

6.7.2 0x15: FF_MT_CFG Freefall/Motion Configuration register

This is the Freefall/Motion configuration register for setting up the conditions of the freefall or motion function.

Table 41. 0x15 FF_MT_CFG register (Read/Write)

Back to Register Address Map

Bit 7	Bit 6	Bit 5	Bit 4	Bit 3	Bit 2	Bit 1	Bit 0
ELE	OAE	ZEFE	YEFE	XEFE	0	0	0

Table 42. FF_MT_CFG register

Bit(s)	Field	Description
7	ELE	<p>Event Latch Enable: Event flags are latched into FF_MT_SRC register. ELE denotes whether the enabled event flag will to be latched into the FF_MT_SRC register or whether the event flag status in the FF_MT_SRC will indicate the real-time status of the event.</p> <ul style="list-style-type: none"> If ELE bit is set to 1, then the event flags are frozen when the EA bit gets set, and the event flags are cleared by reading the FF_MT_SRC source register. Reading the FF_MT_SRC register clears the event flag EA and all FF_MT_SRC bits. <p>0 Event flag latch disabled (default) 1 Event flag latch enabled</p>
6	OAE	<p>Motion detect / Freefall detect flag selection Selects between Motion (logical OR combination) and Freefall (logical AND combination) detection.</p> <p>0 Freefall flag (Logical AND combination) (default) 1 Motion flag (Logical OR combination)</p>
5	ZEFE	<p>Event flag enable on Z ZHFE enables the detection of a motion or freefall event when the measured acceleration data on Z channel is beyond the threshold set in FF_MT_THS register.</p> <ul style="list-style-type: none"> If ELE bit (FF_MT_CFG register) is set to 1, then new event flags are blocked from updating the FF_MT_SRC register. <p>0 Event detection disabled (default) 1 Raise event flag on measured acceleration value beyond preset threshold</p>
4	YEFE	<p>Event flag enable on Y event YEFE enables the detection of a motion or freefall event when the measured acceleration data on Y channel is beyond the threshold set in FF_MT_THS register.</p> <ul style="list-style-type: none"> If ELE bit (FF_MT_CFG register) is set to 1, then new event flags are blocked from updating the FF_MT_SRC register. <p>0 Event detection disabled (default) 1 Raise event flag on measured acceleration value beyond preset threshold</p>
3	XEFE	<p>Event flag enable on X event XEFE enables the detection of a motion or freefall event when the measured acceleration data on X channel is beyond the threshold set in FF_MT_THS register.</p> <ul style="list-style-type: none"> If ELE bit (FF_MT_CFG register) is set to 1, then new event flags are blocked from updating the FF_MT_SRC register. <p>0 Event detection disabled (default) 1 Raise event flag on measured acceleration value beyond preset threshold</p>
2-0	0	

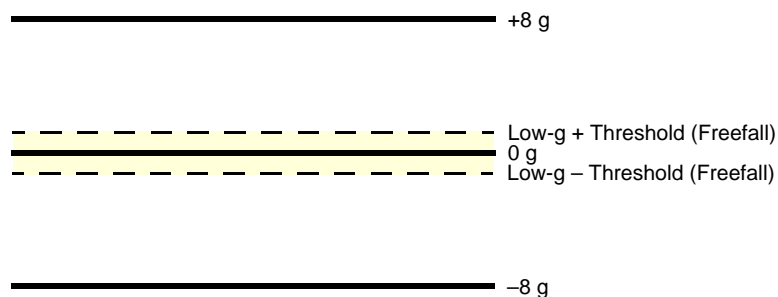

Figure 14. FF_MT_CFG low-g threshold (freefall)

6.7.3 0x16: FF_MT_SRC Freefall/Motion Source register

The Freefall/Motion Source register keeps track of the acceleration event that is triggering (or has triggered, if ELE bit in FF_MT_CFG register is set to 1) the event flag. In particular, EA is set to 1 when the logical combination of acceleration events flags specified in FF_MT_CFG register is true. This EA bit is used *in combination with the values in INT_EN_FF_MT and INT_CFG_FF_MT register bits* to generate the freefall/motion interrupts.

- An X,Y, or Z motion is true when the acceleration value of the X or Y or Z channel is higher than the preset threshold value defined in the FF_MT_THS register.
- An X, Y, and Z low event is true when the acceleration value of the X and Y and Z channel is lower than or equal to the preset threshold value defined in the FF_MT_THS register.

Table 43. 0x16: FF_MT_SRC Freefall/Motion Source register (Read-Only)

Back to Register Address Map

Bit 7	Bit 6	Bit 5	Bit 4	Bit 3	Bit 2	Bit 1	Bit 0
EA	0	ZHE	ZHP	YHE	YHP	XHE	XHP

Table 44. Freefall/Motion Source register

Bit(s)	Field	Description
7	EA	Event Active flag 0 No event flag has been asserted (default) 1 One or more event flags has been asserted. See the description of the OAE bit to determine the effect of the 3-axis event flags on the EA bit.
6	0	
5	ZHE	Z-Motion flag ZHE bit always reads zero if the ZEFE control bit is set to zero. 0 No Z motion event detected (default) 1 Z motion has been detected
4	ZHP	Z-Motion Polarity Flag ZHP bit always reads zero if the ZEFE control bit is set to zero. 0 Z event was positive g (default) 1 Z event was negative g
3	YHE	Y-Motion Flag YHE bit always reads zero if the YEFE control bit is set to zero. 0 No Y motion event detected (default) 1 Y motion has been detected
2	YHP	Y-Motion Polarity Flag YHP bit always reads zero if the YEFE control bit is set to zero. 0 Y event detected was positive g (default) 1 Y event was negative g
1	XHE	X-Motion Flag XHE bit always reads zero if the XEFE control bit is set to zero. 0 No X motion event detected (default) 1 X motion has been detected
0	XHP	X-Motion Polarity Flag XHP bit always reads zero if the XEFE control bit is set to zero. 0 X event was positive g (default) 1 X event was negative g

6.7.4 0x17: FF_MT_THS Freefall and Motion Threshold register

FF_MT_THS is the threshold register used to detect freefall motion events.

- The unsigned 7-bit FF_MT_THS threshold register holds the threshold for the freefall detection **where the magnitude of the X and Y and Z acceleration values is lower or equal than the threshold value.**
- Conversely, the FF_MT_THS also holds the threshold for the motion detection **where the magnitude of the X or Y or Z acceleration value is higher than the threshold value.**

Table 45. 0x17 FF_MT_THS register (Read/Write)

Back to Register Address Map

Bit 7	Bit 6	Bit 5	Bit 4	Bit 3	Bit 2	Bit 1	Bit 0
DBCNTM	THS6	THS5	THS4	THS3	THS2	THS1	THS0

Table 46. FF_MT_THS register

Bit(s)	Field	Description
7	DBCNTM	Debounce counter mode selection 0 Increments or decrements debounce (default) 1 Increments or clears counter.
6-0	THS[6:0]	Freefall /Motion Threshold 000_0000 (default)

The threshold resolution is 0.063 g/LSB and the threshold register has a range of 0 to 127 counts. The maximum range is to ± 8 g. Note that even when the full scale value is set to ± 2 g or ± 4 g, the motion still detects up to ± 8 g.

The DBCNTM bit configures the way in which the debounce counter is reset when the inertial event of interest is momentarily not true.

- When the DBCNTM bit is 1**, the debounce counter is cleared to 0 whenever the inertial event of interest is no longer true as shown in [Figure 15](#), (b).
- While the DBCNTM bit is set to 0**, the debounce counter is decremented by 1 whenever the inertial event of interest is no longer true ([Figure 15](#), (c)) until the debounce counter reaches 0 or until the inertial event of interest becomes active.

Decrementing the debounce counter acts as a median enabling the system to filter out irregular spurious events (which might impede the detection of inertial events).

6.7.5 0x18 FF_MT_COUNT Debounce register

The Debounce register sets the number of debounce sample counts for the event trigger.

Table 47. 0x18 FF_MT_COUNT register (Read/Write)

Back to Register Address Map

Bit 7	Bit 6	Bit 5	Bit 4	Bit 3	Bit 2	Bit 1	Bit 0
D7	D6	D5	D4	D3	D2	D1	D0

Table 48. FF_MT_COUNT register

Bit(s)	Field	Description
7-0	D[7:0]	Count value 0000_0000 (default)

The Debounce register sets the minimum number of debounce sample counts that continuously match the detection condition selected by you for the freefall/motion event.

When the internal debounce counter reaches the FF_MT_COUNT value, a freefall/motion event flag is set. The debounce counter will never increase beyond the FF_MT_COUNT value. The time step used for the debounce sample count depends on the ODR chosen and the Oversampling mode, as shown in [Table 57](#).

Table 49. FF_MT_COUNT relationship with the ODR

ODR (Hz)	Max Time Range (s)				Time Step (ms)			
	Normal	LPLN	HighRes	LP	Normal	LPLN	HighRes	LP
800	0.319	0.319	0.319	0.319	1.25	1.25	1.25	1.25
400	0.638	0.638	0.638	0.638	2.5	2.5	2.5	2.5
200	1.28	1.28	0.638	1.28	5	5	2.5	5
100	2.55	2.55	0.638	2.55	10	10	2.5	10
50	5.1	5.1	0.638	5.1	20	20	2.5	20
12.5	5.1	20.4	0.638	20.4	20	80	2.5	80
6.25	5.1	20.4	0.638	40.8	20	80	2.5	160
1.56	5.1	20.4	0.638	40.8	20	80	2.5	160

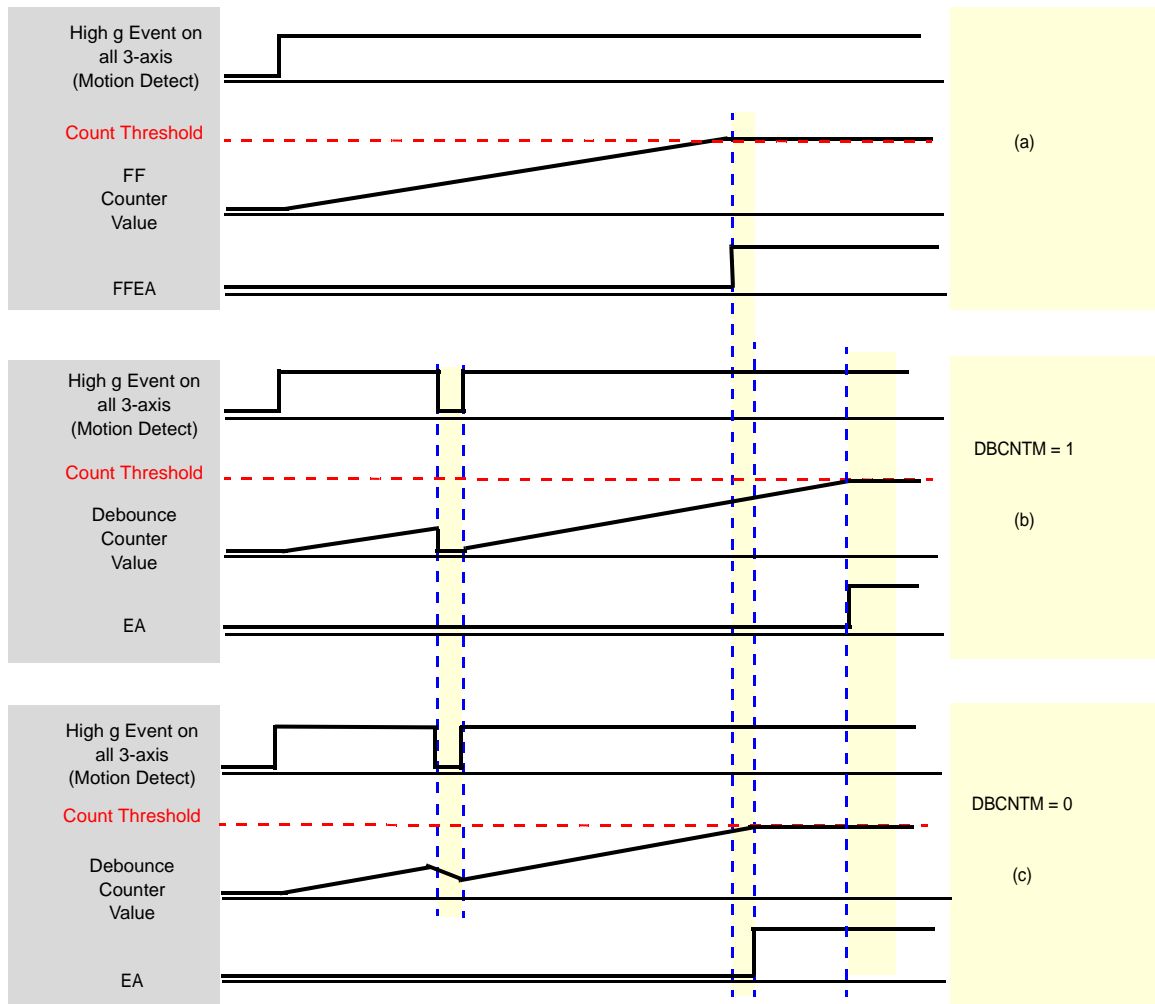

Figure 15. DBCNTM bit function

6.8 Auto-WAKE/SLEEP detection

6.8.1 0x29: ASLP_COUNT, Auto-WAKE/SLEEP Detection register (Read/Write)

The ASLP_COUNT register sets the *minimum time period of inactivity required* to switch the part between Wake and Sleep status. At the end of the time period, the device switches its ODR rate automatically when the Auto-WAKE /SLEEP function is enabled.

- Wake ODR is set by **CTRL_REG1[DR]** bits.
- Sleep ODR is set by **CTRL_REG1[ASLP_RATE]** bits.
- Auto WAKE/SLEEP function is enabled by asserting the **CTRL_REG2[SLPE]** bit.

Table 50. 0x29 ASLP_COUNT register (Read/Write)

[Back to Register Address Map](#)

Bit 7	Bit 6	Bit 5	Bit 4	Bit 3	Bit 2	Bit 1	Bit 0
D7	D6	D5	D4	D3	D2	D1	D0

Table 51. ASLP_COUNT register

Bit(s)	Field	Description
7-0	D[7:0]	Duration value 0000_0000 (default)

D7–D0 defines the minimum duration time needed to change the current ODR value from **DR** to **ASLP_RATE**. The time step and maximum value depend on the ODR chosen (as shown in [Table 91](#)).

Table 52. ASLP_COUNT relationship with ODR

Output Data Rate (ODR)	Duration (sec)	ODR Time Step (ms)	ASLP_COUNT Step (ms)
800 Hz	0 to 81	1.25	320
400 Hz	0 to 81	2.5	320
200 Hz	0 to 81	5	320
100 Hz	0 to 81	10	320
50 Hz	0 to 81	20	320
12.5 Hz	0 to 81	80	320
6.25 Hz	0 to 81	160	320
1.56 Hz	0 to 162	640	640

For functional blocks that may be monitored for inactivity (to trigger the “return to SLEEP” event), see [Table 53](#).

Table 53. SLEEP/WAKE mode gates and triggers

Interrupt Source	Will the event restart the timer and delay “Return to SLEEP”?	Will the event WAKE from SLEEP?
SRC_LNDPRT	Yes	Yes
SRC_FF_MT	Yes	Yes
SRC_ASLP	No*	No*
SRC_DRDY	No	No

- Two interrupt sources can WAKE the device: Orientation and Motion/Freefall. One or more of these functions can be enabled.
 - To WAKE the device, the desired function(s) must be enabled in CTRL_REG4 register and set to WAKE-to-SLEEP in CTRL_REG3 register.
 - All enabled functions still run in SLEEP mode at the SLEEP ODR. Only the functions that have been selected for WAKE from SLEEP will actually WAKE the device (as configured in register 0x2C).
 - The Auto-WAKE/SLEEP interrupt does not affect the WAKE/SLEEP, nor does the data ready interrupt.

MMA8653FC

- MMA8653FC has two functions that can be used to keep the sensor from falling asleep: Orientation and Motion/Freefall.
- Auto-SLEEP bit:
 - If the Auto-SLEEP bit is disabled, then the device can only toggle between STANDBY and WAKE mode.
 - If Auto-SLEEP interrupt is enabled, then transitioning from ACTIVE mode to Auto-SLEEP mode (or vice versa) generates an interrupt.

6.9 System and control registers

NOTE

Except for STANDBY mode selection, the device must be in STANDBY mode to change any of the fields within CTRL_REG1 (0x2A).

6.9.1 0x2A: CTRL_REG1 System Control 1 register

CTRL_REG1 register configures the Auto-WAKE sample frequency, output data rate selection, and enables the fast-read mode and STANDBY/ACTIVE mode selection.

Table 54. 0x2A CTRL_REG1 register (Read/Write)

Back to Register Address Map

Bit 7	Bit 6	Bit 5	Bit 4	Bit 3	Bit 2	Bit 1	Bit 0
ASLP_RATE1	ASLP_RATE0	DR2	DR1	DR0	0	F_READ	ACTIVE

Table 55. CTRL_REG1 register

Bit(s)	Field	Description
7–6	ASLP_RATE[1:0]	Configures the Auto-WAKE sample frequency when the device is in SLEEP Mode. See Table 95 . 00 (default)
5–3	DR[2:0]	Data rate selection See Table 96 . 000 (default)
2	0	
1	F_READ	Fast-read mode: Data format is limited to single byte 0 Normal mode (default) 1 Fast Read Mode
0	ACTIVE	Full-scale selection 0 STANDBY mode (default) 1 ACTIVE mode

Table 56. SLEEP mode rates

ASLP_RATE1	ASLP_RATE0	Frequency (Hz)	Notes
0	0	50	When the device is in Auto-SLEEP mode, the system ODR and the data rate for all the system functional blocks are overridden by the data rate set by the ASLP_RATE field.
0	1	12.5	
1	0	6.25	
1	1	1.56	

DR[2:0] bits select the Output Data Rate (ODR) for acceleration samples in WAKE mode. The default value is 000 for a data rate of 800 Hz.

Table 57. System output data-rate selection

DR2	DR1	DR0	ODR (Hz)	Period (ms)	Notes
0	0	0	800	1.25	default
0	0	1	400	2.5	
0	1	0	200	5	
0	1	1	100	10	
1	0	0	50	20	
1	0	1	12.5	80	
1	1	0	6.25	160	
1	1	1	1.56	640	

The ACTIVE bit selects between STANDBY mode and ACTIVE mode.

Table 58. Full-Scale selection using ACTIVE bit

Active bit	Mode
0	STANDBY (default)
1	ACTIVE

- The F_Read bit selects between normal and Fast Read mode. When selected, the auto-increment counter will skip over the LSB data bytes. Data read from the FIFO will skip over the LSB data, reducing the acquisition time.
- Note that F_READ can only be changed when FMODE = 00.
- The F_READ bit applies for the output registers.

6.9.2 0x2B: CTRL_REG2 System Control 2 register

CTRL_REG2 register is used to enable Self-Test, Software Reset, and Auto-SLEEP. In addition, it enables you to configure the SLEEP and WAKE mode power scheme selection (oversampling modes).

Table 59. 0x2B CTRL_REG2 register (Read/Write)

Back to Register Address Map

Bit 7	Bit 6	Bit 5	Bit 4	Bit 3	Bit 2	Bit 1	Bit 0
ST	RST	—	SMODS1	SMODS0	SLPE	MODS1	MODS0

Table 60. CTRL_REG2 register

Bit(s)	Field	Description
7	ST	Self-Test Enable Activates the self-test function. <ul style="list-style-type: none"> When ST is set, the X, Y, and Z outputs will shift. 0 Self-Test disabled (default) 1 Self-Test enabled
6	RST	Software Reset RST bit is used to activate the software reset. <ul style="list-style-type: none"> The reset mechanism is enabled in both STANDBY and ACTIVE modes. 0 Device reset disabled (default) 1 Device reset enabled.
5	—	Could be 0 or 1.
4-3	SMODS[1:0]	SLEEP mode power scheme selection See Table 100 and Table 101 00 (default)
2	SLPE	Auto-SLEEP enable 0 Auto-SLEEP is not enabled (default) 1 Auto-SLEEP is enabled.
1-0	MODS[1:0]	ACTIVE mode power scheme selection See Table 100 and Table 101 00 (default)

When the reset bit is enabled, all registers are reset and are loaded with default values. Writing '1' to the RST bit immediately resets the device, no matter whether it is in ACTIVE/WAKE, ACTIVE/SLEEP, or STANDBY mode.

The I²C communication system is reset to avoid accidental corrupted data access.

At the end of the boot process the RST bit is deasserted to 0. Reading this bit will return a value of zero.

The (S)MODS[1:0] bits select which Oversampling mode is to be used, as shown in [Table 100](#). The Oversampling modes are available in both WAKE Mode MOD[1:0] and also in the SLEEP Mode SMOD[1:0].

Table 61. (S)MODS Oversampling modes

(S)MODS1	(S)MODS0	Power Mode
0	0	Normal
0	1	Low Noise Low Power
1	0	High Resolution
1	1	Low Power

Table 62. MODS Oversampling modes averaging values at each ODR

ODR (Hz)	Mode							
	Normal (00)		Low Noise Low Power (01)		High Resolution (10)		Low Power (11)	
	Current μ A	OS Ratio	Current μ A	OS Ratio	Current μ A	OS Ratio	Current μ A	OS Ratio
1.56	27	128	9	32	184	1024	6.5	16
6.25	27	32	9	8	184	256	6.5	4
12.5	27	16	9	4	184	128	6.5	2
50	27	4	27	4	184	32	15	2
100	49	4	49	4	184	16	26	2
200	94	4	94	4	184	8	49	2
400	184	4	184	4	184	4	94	2
800	184	2	184	2	184	2	184	2

6.9.3 0x2C: CTRL_REG3 Interrupt Control register

CTRL_REG3 register is used to control the Auto-WAKE/SLEEP function by setting the orientation or Freefall/Motion as an interrupt to wake. CTRL_REG3 register also configures the interrupt pins INT1 and INT2.

Table 63. 0x2C CTRL_REG3 register (Read/Write)*Back to Register Address Map*

Bit 7	Bit 6	Bit 5	Bit 4	Bit 3	Bit 2	Bit 1	Bit 0
—	—	WAKE_LNDPRT	—	WAKE_FF_MT	0	IPOL	PP_OD

Table 64. CTRL_REG3 register

Bit(s)	Field	Description
7-6	—	Could be 0 or 1.
5	WAKE_LNDPRT	Wake from Orientation interrupt 0 Orientation function is bypassed in SLEEP mode. (default) 1 Orientation function interrupt can wake up system
4	—	Could be 0 or 1.
3	WAKE_FF_MT	Wake from Freefall/Motion interrupt 0 Freefall/Motion function is bypassed in SLEEP mode. (default) 1 Freefall/Motion function interrupt can wake up
2	0	
1	IPOL	Interrupt polarity Selects the polarity of the interrupt signals. When IPOL is 0 (default value), any interrupt event is signaled with a logical 0. 0 ACTIVE low (default) 1 ACTIVE high
0	PP_OD	Push-Pull/Open-Drain selection on interrupt pad Configures the interrupt pins to Push-Pull or to Open-Drain mode. The Open-Drain configuration can be used for connecting multiple interrupt signals on the same interrupt line. 0 Push-Pull (default) 1 Open Drain

6.9.4 0x2D: CTRL_REG4 Interrupt Enable register (Read/Write)

CTRL_REG4 register enables the following interrupts: Auto-WAKE/SLEEP, Orientation Detection, Freefall/Motion, and Data Ready.

Table 65. 0x2D CTRL_REG4 Interrupt Enable register (Read/Write)*Back to Register Address Map*

Bit 7	Bit 6	Bit 5	Bit 4	Bit 3	Bit 2	Bit 1	Bit 0
INT_EN_ASLP	—	—	INT_EN_LNDPRT	—	INT_EN_FF_MT	0	INT_EN_DRDY

Table 66. CTRL_REG4 register

Bit(s)	Field	Description
7	INT_EN_ASLP	Auto-SLEEP/WAKE Interrupt Enable
6	—	Could be 0 or 1.
5	—	Could be 0 or 1.
4	INT_EN_LNDPRT	Orientation (Landscape/Portrait) Interrupt Enable
3	—	Could be 0 or 1.
2	INT_EN_FF_MT	Freefall/Motion Interrupt Enable
0	INT_EN_DRDY	Data Ready Interrupt Enable

0 interrupt is disabled (default)
1 interrupt is enabled

Note: The corresponding functional block interrupt enable bit enables the functional block to route its event detection flags to the system's interrupt controller. The interrupt controller routes the enabled functional block interrupt to the INT1 or INT2 pin.

6.9.5 0x2E CTRL_REG5 Interrupt Configuration register (Read/Write)

CTRL_REG5 register maps the desired interrupts to INT2 or INT1 pins.

The system's interrupt controller, shown in [Figure 9](#), uses the corresponding bit field in the CTRL_REG5 register to determine the routing table for the INT1 and INT2 interrupt pins.

- If the bit value is 0, then the functional block's interrupt is routed to INT2.
- If the bit value is 1, then the functional block's interrupt is routed to INT1.

One or more functions can assert an interrupt pin; therefore a host application responding to an interrupt should read the INT_SOURCE (0x0C) register, to determine the appropriate sources of the interrupt.

Table 67. 0x2E: CTRL_REG5 Interrupt Configuration register*Back to Register Address Map*

Bit 7	Bit 6	Bit 5	Bit 4	Bit 3	Bit 2	Bit 1	Bit 0
INT_CFG_ASLP	—	—	INT_CFG_LNDPRT	—	INT_CFG_FF_MT	0	INT_CFG_DRDY

Table 68. 0x2E CTRL_REG5 register

Bit(s)	Field	Description
7	INT_CFG_ASLP	Auto-SLEEP/WAKE INT1/INT2 Configuration
6	—	Could be 0 or 1.
5	—	Could be 0 or 1.
4	INT_CFG_LNDPRT	Orientation INT1/INT2 Configuration
3	—	Could be 0 or 1.
2	INT_CFG_FF_MT	Freefall/motion INT1/INT2 Configuration
1	0	
0	INT_CFG_DRDY	Data Ready INT1/INT2 Configuration

0 Interrupt is routed to INT2 pin (default)
1 Interrupt is routed to INT1 pin

6.10 Data calibration registers

The 2's complement offset correction registers values are used to realign the Zero-g position of the X, Y, and Z-axis after the device is mounted on a board. The resolution of the offset registers is 1.96 mg/LSB. The 2's complement 8-bit value would result in an offset compensation range ± 250 mg for each axis.

6.10.1 0x2F: OFF_X Offset Correction X register

Table 69. 0x2F OFF_X register (Read/Write)

Back to Register Address Map

Bit 7	Bit 6	Bit 5	Bit 4	Bit 3	Bit 2	Bit 1	Bit 0
D7	D6	D5	D4	D3	D2	D1	D0

Table 70. OFF_X register

Bit(s)	Field	Description
7-0	D[7:0]	X-axis offset value 0000_0000 (default)

6.10.2 0x30: OFF_Y Offset Correction Y register

Table 71. 0x30 OFF_Y register (Read/Write)

Back to Register Address Map

Bit 7	Bit 6	Bit 5	Bit 4	Bit 3	Bit 2	Bit 1	Bit 0
D7	D6	D5	D4	D3	D2	D1	D0

Table 72. OFF_Y register

Bit(s)	Field	Description
7-0	D[7:0]	Y-axis offset value 0000_0000 (default)

6.10.3 0x31: OFF_Z Offset Correction Z register

Table 73. 0x31 OFF_Z register (Read/Write)

Back to Register Address Map

Bit 7	Bit 6	Bit 5	Bit 4	Bit 3	Bit 2	Bit 1	Bit 0
D7	D6	D5	D4	D3	D2	D1	D0

Table 74. OFF_Z register

Bit(s)	Field	Description
7-0	D[7:0]	Z-axis offset value 0000_0000 (default)

7 Mounting Guidelines

Surface mount printed circuit board (PCB) layout is a critical portion of the total design. The footprint for the surface mount packages must be the correct size to ensure proper solder connection interface between the PCB and the package. With the correct footprint, the packages will self-align when subjected to a solder reflow process. These guidelines are for soldering and mounting the Dual Flat No-Lead (DFN) package inertial sensors to PCBs. The purpose is to minimize the stress on the package after board mounting. The MMA865xFC digital output accelerometers use the DFN package platform. This section describes suggested methods of soldering these devices to the PCB for consumer applications.

7.1 Overview of soldering considerations

Information provided here is based on experiments executed on DFN devices. They do not represent exact conditions present at a customer site. Therefore, this information should be used as guidance only and process and design optimizations are recommended to develop an application specific solution. It should be noted that with the proper PCB footprint and solder stencil designs, the package will self-align during the solder reflow process.

7.2 Halogen content

This package is designed to be Halogen Free, exceeding most industry and customer standards. Halogen Free means that no homogeneous material within the assembly package shall contain chlorine (Cl) in excess of 700 ppm or 0.07% weight/weight or bromine (Br) in excess of 900 ppm or 0.09% weight/weight.

7.3 PCB mounting/soldering recommendations

1. The PCB land should be designed as Non Solder Mask Defined (NSMD) as shown in [Figure 16](#).
2. No additional via pattern underneath package.
3. PCB land pad is 0.6 mm x 0.225 mm as shown in [Figure 16](#).
4. Solder mask opening = PCB land pad edge + 0.125 mm larger all around = 0.725 mm x 1.950 mm
5. Stencil opening = PCB land pad – 0.05 mm smaller all around = 0.55 mm x 0.175 mm.
6. Stencil thickness is 100 or 125 μ m.
7. Do not place any components or vias at a distance less than 2 mm from the package land area. This may cause additional package stress if it is too close to the package land area.
8. Signal traces connected to pads are as symmetric as possible. Put dummy traces on NC pads, to have same length of exposed trace for all pads.
9. Use a standard pick and place process and equipment. Do not use a hand soldering process.
10. Use caution when putting an assembled PCB into an enclosure, noting where the screw-down holes are and if any press-fitting is involved. It is important that the assembled PCB remain flat after assembly, to ensure optimal electronic operation of the device.
11. The PCB should be rated for the multiple lead-free reflow condition with max 260°C temperature.
12. No copper traces on top layer of PCB under the package. This will cause planarity issues with board mount. Freescale DFN sensors are compliant with Restrictions on Hazardous Substances (RoHS), having halide free molding compound (green) and lead-free terminations. These terminations are compatible with tin-lead (Sn-Pb) as well as tin-silver-copper (Sn-Ag-Cu) solder paste soldering processes. Reflow profiles applicable to those processes can be used successfully for soldering the devices.

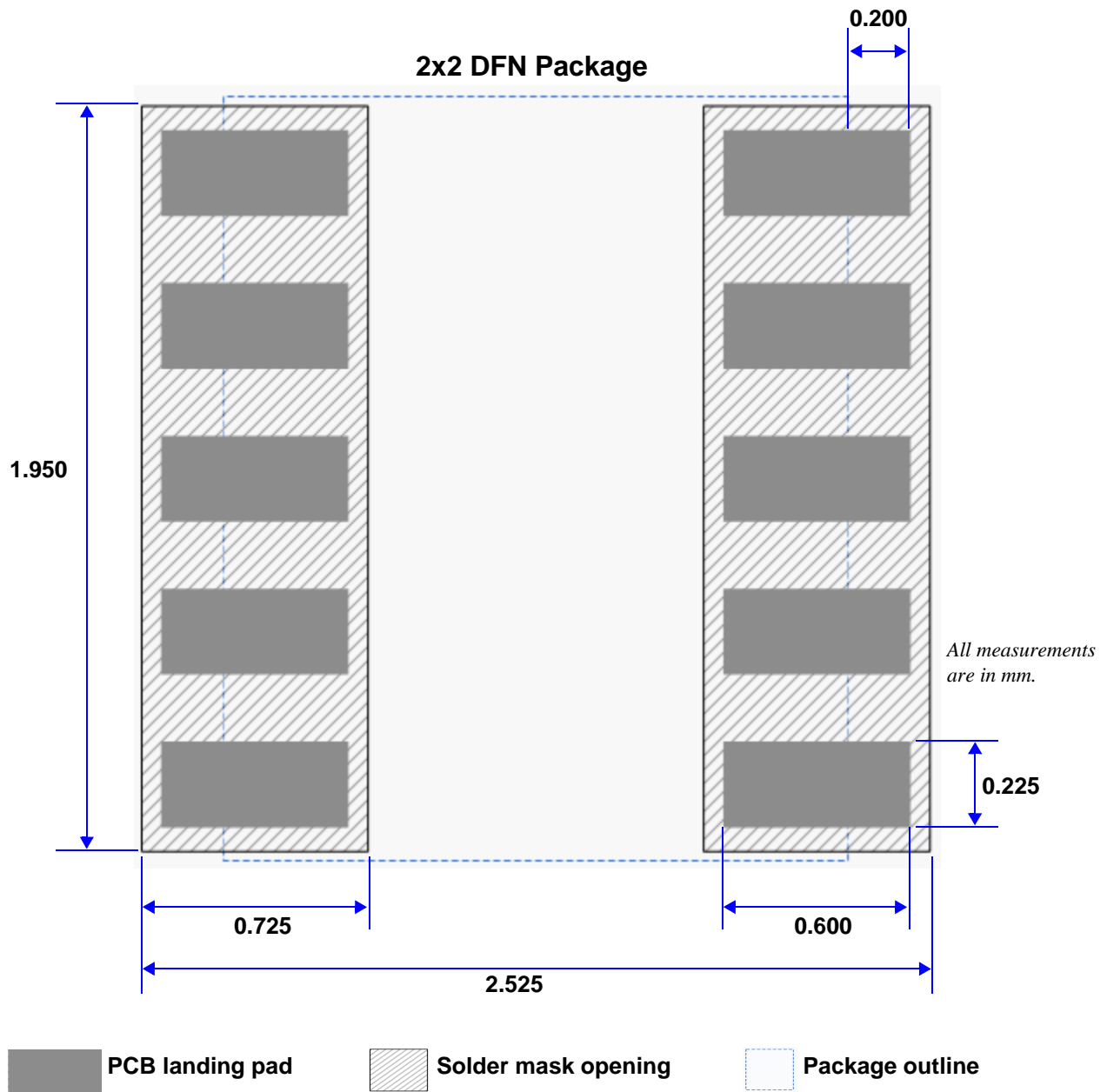

Figure 16. Package mounting measurements

Table 75. Board mounting guidelines

Description	Value (mm)
Landing Pad Width	0.225
Landing Pad Length	0.600
Solder Mask Pattern Width	0.725
Solder Mask Pattern Length	1.950
Landing Pad Extended Length	0.200
I/O Pads Extended Length	2.525

8 Tape and Reel

8.1 Tape dimensions

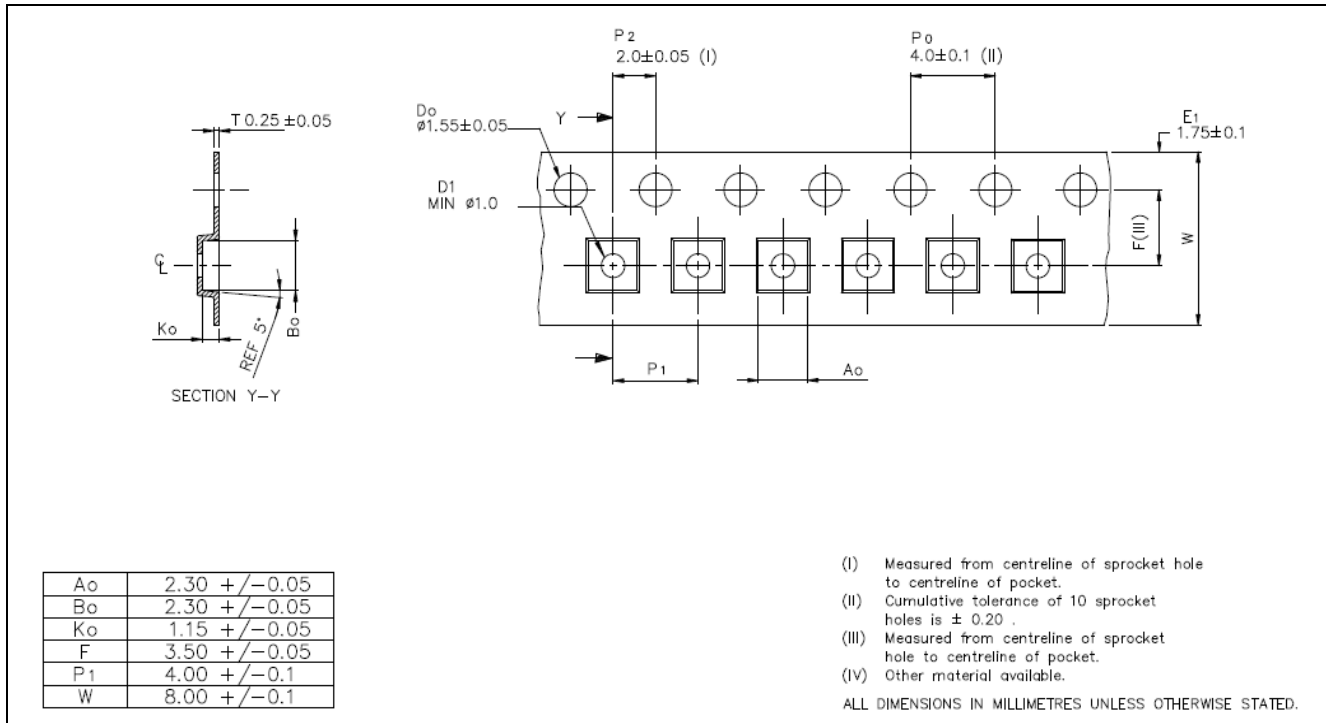

Figure 17. Carrier tape

8.2 Device orientation

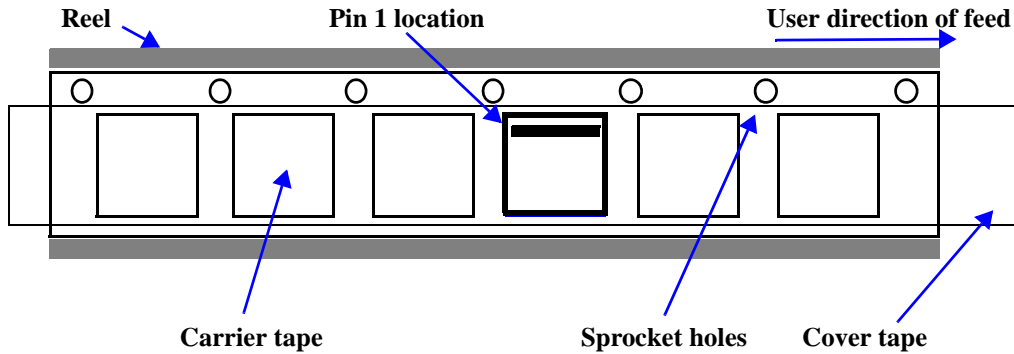
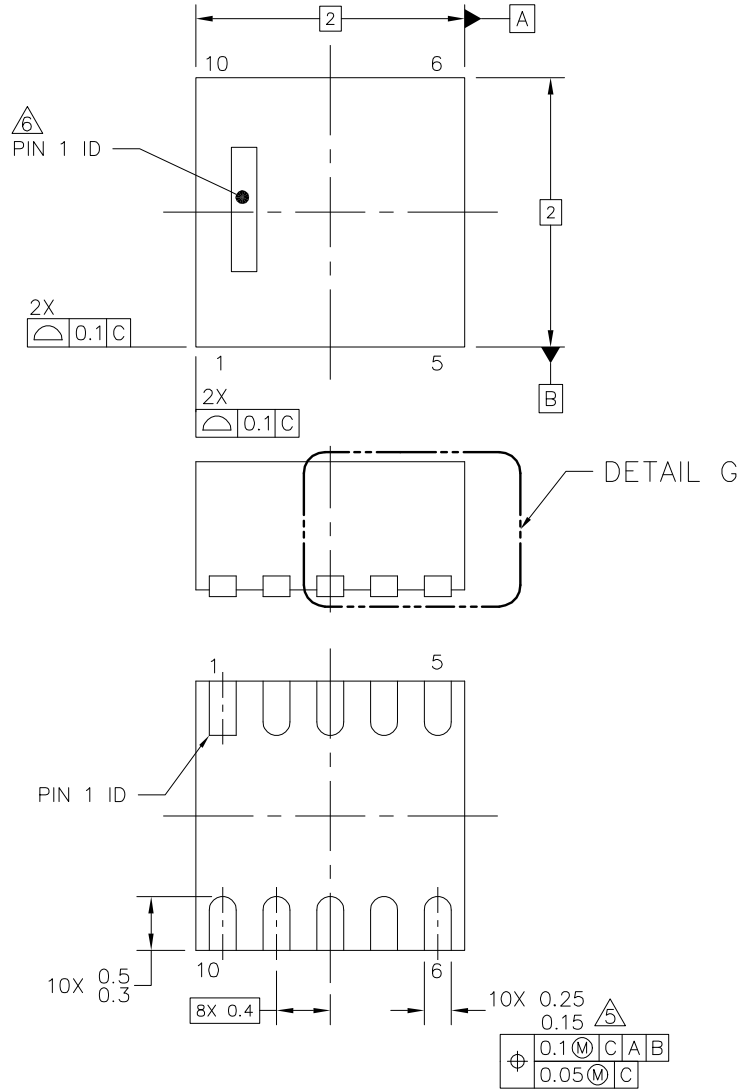

Figure 18. Device orientation on carrier tape

9 Package Dimensions



© FREESCALE SEMICONDUCTOR, INC. ALL RIGHTS RESERVED.	MECHANICAL OUTLINE	PRINT VERSION NOT TO SCALE	
TITLE: DFN-COL, 2 X 2 X 0.95, 0.4 PITCH, 10 TERMINAL	DOCUMENT NO: 98ASA00301D	REV: A	
	CASE NUMBER: 2162-02	30 MAY 2012	
	STANDARD: NON-JEDEC		

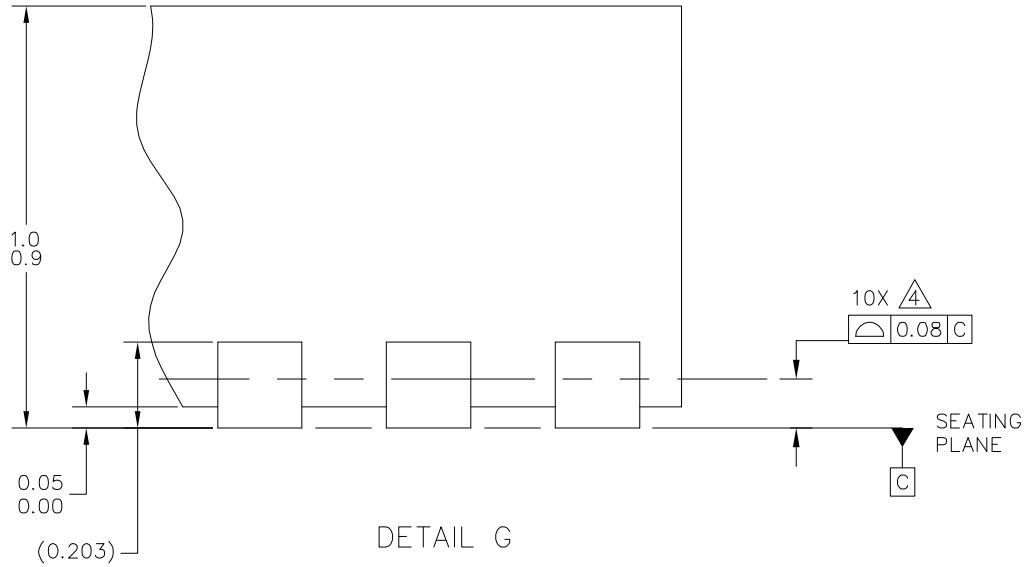

Figure 19. CASE 2162-02, ISSUE O, 10-Lead DFN—page 1



© FREESCALE SEMICONDUCTOR, INC. ALL RIGHTS RESERVED.	MECHANICAL OUTLINE	PRINT VERSION NOT TO SCALE	
TITLE: DFN-COL, 2 X 2 X 0.95, 0.4 PITCH, 10 TERMINAL		DOCUMENT NO: 98ASA00301D	REV: A
		CASE NUMBER: 2162-02	30 MAY 2012
		STANDARD: NON-JEDEC	

Figure 20. CASE 2162-02, ISSUE O, 10-Lead DFN—page 2

NOTES:

1. ALL DIMENSIONS ARE IN MILLIMETERS.
2. DIMENSIONING AND TOLERANCING PER ASME Y14.5M-1994.
3. THIS IS NON JEDEC REGISTERED PACKAGE.
4.  COPLANARITY APPLIES TO ALL TERMINALS.
5.  THIS DIMENSION APPLIES TO METALLIZED TERMINAL AND IS MEASURE BETWEEN 0.15 AND 0.25 FROM THE TERMINAL TIP. IF THE TERMINAL HAS THE OPTIONAL RADIUS ON THE OTHER END OF THE TERMINAL, THIS DIMENSION SHALL NOT BE MEASURED IN THE RADIUS AREA.
6.  PIN 1 ID ON TOP WILL BE LASER MARKED.

© FREESCALE SEMICONDUCTOR, INC. ALL RIGHTS RESERVED.	MECHANICAL OUTLINE	PRINT VERSION NOT TO SCALE	
TITLE: DFN-COL, 2 X 2 X 0.95, 0.4 PITCH, 10 TERMINAL		DOCUMENT NO: 98ASA00301D	REV: A
		CASE NUMBER: 2162-02	30 MAY 2012
		STANDARD: NON-JEDEC	

Figure 21. CASE 2162-02, ISSUE O, 10-Lead DFN—page 3

10 Revision History

Table 76. Revision history for MMA8653FC

Revision number	Revision date	Description of changes
0	08/2012	<ul style="list-style-type: none"> Initial release
1.0	02/2013	<ul style="list-style-type: none"> Title and introductory text, changed 12-bit to 10-bit. Feature comparison table: Orientation Detection features (2) rewritten for clarification. Section 1: Topics reordered for clarification and consistency. Table 4: Self-Test Output Change, x, y, and z specification values changed. Tables 8, 9: Changed units to emg/LSB. Section 5.5: Freefall detection rewritten for clarification. Section 5.6 Orientation detection rewritten for clarification. Section 6.4: FIFO-related content deleted. Section 6.5.1: FIFO-related content deleted. Table 19: bit field values deleted. Section 6.7.4: rewritten for clarification. Section 6.8.2: replaced Figure 32. Table 32: FIFO-related content deleted. Section 6.10.1: FIFO-related content deleted. Note following Table 39: deleted as unnecessary.
2.0	06/2014	<ul style="list-style-type: none"> Section 1.2: Updated Descriptions for Pins 3 and 4. Section 6.9.2: Replaced contents of Table 64.

How to Reach Us:

Home Page:

freescale.com

Web Support:

freescale.com/support

Information in this document is provided solely to enable system and software implementers to use Freescale products. There are no express or implied copyright licenses granted hereunder to design or fabricate any integrated circuits based on the information in this document.

Freescale reserves the right to make changes without further notice to any products herein. Freescale makes no warranty, representation, or guarantee regarding the suitability of its products for any particular purpose, nor does Freescale assume any liability arising out of the application or use of any product or circuit, and specifically disclaims any and all liability, including without limitation consequential or incidental damages. "Typical" parameters that may be provided in Freescale data sheets and/or specifications can and do vary in different applications, and actual performance may vary over time. All operating parameters, including "typicals," must be validated for each customer application by customer's technical experts. Freescale does not convey any license under its patent rights nor the rights of others. Freescale sells products pursuant to standard terms and conditions of sale, which can be found at the following address: freescale.com/salestermsandconditions.

Freescale and the Freescale logo are trademarks of Freescale Semiconductor, Inc., Reg. U.S. Pat. & Tm. Off. Xtrinsic is a trademarks of Freescale Semiconductor, Inc. All other product or service names are the property of their respective owners.

© 2014 Freescale Semiconductor, Inc.

Document Number: MMA8653FC

Rev. 2.0

06/2014

