



SEN-R65

Magneto-Inductive Sensor



General Description

The SEN-R is the newest version of PNI Corporation's Magneto-Inductive (MI) sensors. It is designed as a replacement for the SEN-S. The SEN-R is based on patented technology that delivers breakthrough, cost-effective magnetic field sensing performance. These sensors change inductance by 100% over their field measurement range. This variable inductance property is used in a patented temperature and noise stabilized oscillator/counter circuit to detect field variations. The PNI Sensor Driver ASIC is the recommended implementation of this patented circuit, and can be used with the SEN-R to construct a magnetometer with up to 3-axes.

Advantages of the SEN-R include low voltage and power, small size surface mount package, large signal noise immunity under all conditions, and a large dynamic range. When used with the PNI ASIC, resolution and field measurement range are software configurable for a variety of applications. The measurement is very stable over temperature and inherently free from offset drift.

These advantages make PNI Corporation's MI sensors the choice for a wide variety of applications.

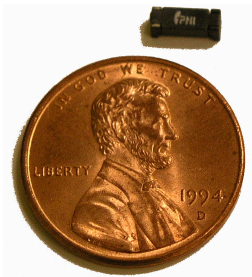

Features

- Low power: draws < 100 μ A at 3 VDC
- Small size: 6.0 x 2.1 x 2.1 mm
- Large field measurement range: $\pm 1100 \mu$ T (± 11 Gauss)
- High resolution field measurement: 0.015 μ T (0.00015 Gauss)
- Wide operational temperature range:
 - -40° to 85°C
- Few external components: PNI ASIC with two resistors per sensor
- Surface mount package supplied on tape & reel
- RoHS Compliant

Applications

- Handheld & compact battery-powered devices with built-in compass feature
- High-performance magnetic field sensing
- High-performance solid-state navigation equipment for automotive, marine and aeronautic applications
- Magnetic object proximity sensing

Ordering Information

| Part # | MOQ | Package | RoHS Compliant |
|--------|-------|-------------|----------------|
| 12683P | <5000 | Cut-Tape | Yes |
| 12683 | 5000 | Tape & Reel | Yes |
| 90030 | 1 | Sample Pack | Yes |

Table 1



This page left intentionally blank

SPECIFICATIONS

CAUTION:

Stresses beyond those listed under **Table 2: Absolute Maximum Ratings** may cause permanent damage to the device. These are stress ratings only. Functional operation of the device at these or any other conditions beyond those indicated in the operational sections of the specifications is not implied. Exposure to absolute maximum rating conditions for extended periods may affect device reliability.

Table 2: Absolute Maximum Ratings

| Symbol | Parameter | Maximum |
|-------------------|---------------------|-----------------|
| V _{coil} | Voltage across coil | 2.0 VDC |
| I _{IN} | Input Pin Current | 50 mA at 25 °C |
| T _{STRG} | Storage Temperature | -40 °C to 85 °C |

Table 3: Sensor Characteristics

| Parameter | Min | Typical | Max | Units |
|--|-----|---------|-----|--------|
| DC resistance at 25 °C ±15 °C ^a | 30 | | 45 | Ω |
| DC resistance versus temperature | | 0.4 | | % / °C |
| Inductance ^b | | 400-600 | | μH |
| Operating Temperature (sensor only) | -40 | | 85 | °C |
| Storage Temperature | -40 | | 85 | °C |

a. Determined with a DC source.

b. No DC bias, 100 kHz at 1 V_{p-p}, orthogonal to Earth's magnetic field

Table 4: Sensor Characteristics

| Parameter | Condition | Min | Typical | Max | Units |
|--------------------------------------|---|-------|---------|------|-------------|
| Current ^a | 3 VDC, Rb = 43Ω | | | 0.5 | mA RMS |
| | 5 VDC, Rb = 68Ω (measured at ASIC V _{cc}) | | | 0.5 | |
| Peak Current | 3 VDC | | 2.5 | | mA |
| | 5 VDC | | 3.8 | | |
| Field measurement range ^b | 3 VDC, Rb = 43Ω | -1100 | | 1100 | μT |
| | 5 VDC, Rb = 68Ω | -1100 | | 1100 | |
| Gain ^c | 3 VDC, Rb = 43Ω | | 27 – 38 | | counts/μT |
| | 5 VDC, Rb = 68Ω | | 18 – 26 | | |
| Linearity | (best fit straight line at ±200 μT) | | 0.6 | 2 | % of 200 μT |
| Resolution ^d | 3V, PS=2048 | | 0.031 | | μT |
| | 5V, PS=2048 | | 0.042 | | |
| Frequency | 3 VDC, Rb = 43Ω (within free Earth's magnetic field) | | 175 | | KHz |

a. Current includes the ASIC and two SEN-R in continuous sequential sampling at 8 Hz and PS of /1024

b. Field measurement range is defined as the monotonic region of the output characteristic curve.

c. Gain is defined as the change in number of counts from the ASIC, when the period select is set to 2048, per change in the magnetic field of μT. For situations requiring higher gain and less field measurement range, the gain and resolution can be increased by a factor of 2 by setting the ASIC period to 4096. When setting higher period selects, be aware that the ASIC counter can overflow if the field is strong enough to drive the count beyond a signed 16-bit integer. Period select set to 2048 is the highest setting where it is impossible to overflow the counter.

d. Resolution is defined as the reciprocal of gain. Maximum resolution obtained by setting the ASIC period select to 4096

For more information, see "PNI ASIC Datasheet"

Table 5: SEN-R Continuous Sampling 3V at 8Hz with PNI ASIC

| Period Select | Ratio | Gain (Counts/μT) | Resolution (μT) | 2-Axis Typical Operating Current (mA RMS) | Typical Sample Time (mSec) |
|---------------|-------|------------------|-----------------|---|----------------------------|
| 0 | /32 | 0.523 | 1.912 | 0.017 | 0.366 |
| 1 | /64 | 1.047 | 0.956 | 0.029 | 0.731 |
| 2 | /128 | 2.094 | 0.478 | 0.053 | 1.46 |
| 3 | /256 | 4.188 | 0.239 | 0.102 | 2.85 |
| 4 | /512 | 8.375 | 0.120 | 0.200 | 5.65 |
| 5 | /1024 | 16.75 | 0.060 | 0.396 | 11.7 |
| 6 | /2048 | 33.5 | 0.030 | 0.788 | 23.4 |
| 7 | /4096 | 67 | 0.015 | 1.569 | 46.8 |

Typical Operating Characteristics

(3VDC; Rb = 43 Ω)

Figure 1: Temperature Characteristics

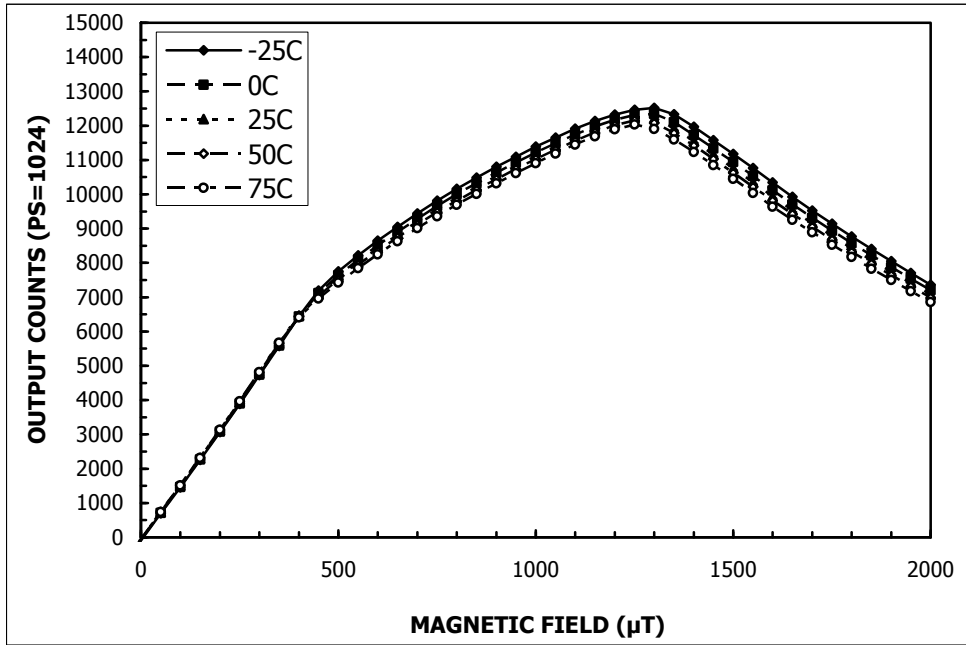

Figure 2: Linearity vs. Temperature

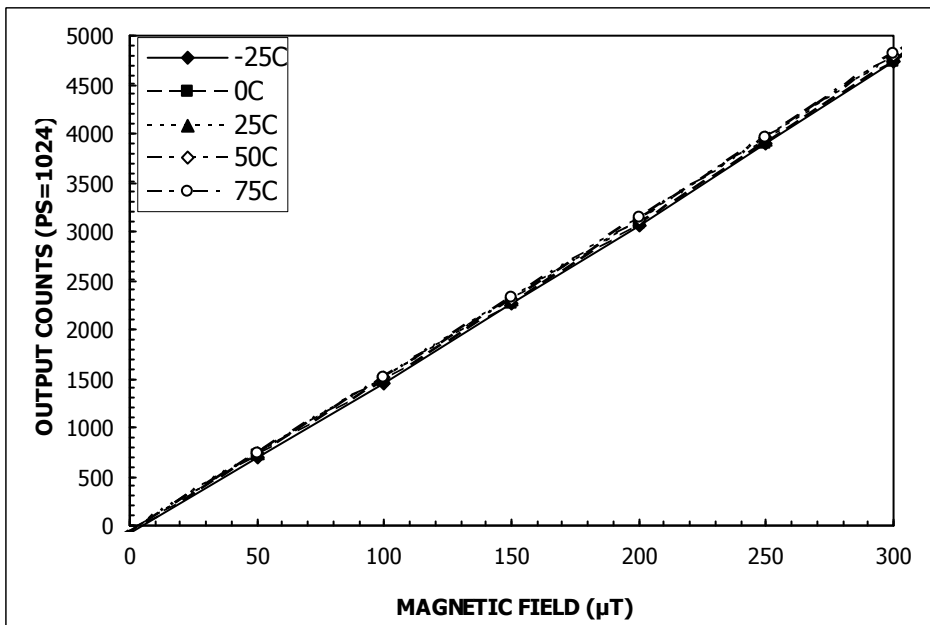

Figure 3: Recommended bias Resistance vs. Supply Voltage

$R_b \approx 14 * V_s$ when using PNI ASIC

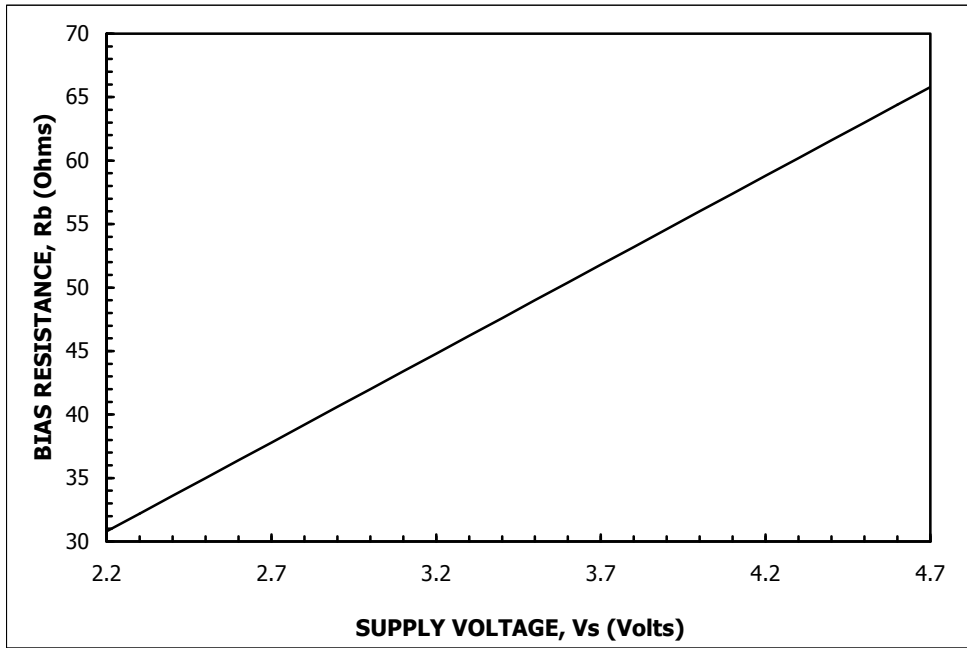

Figure 4: Hysterisis and Repeatability

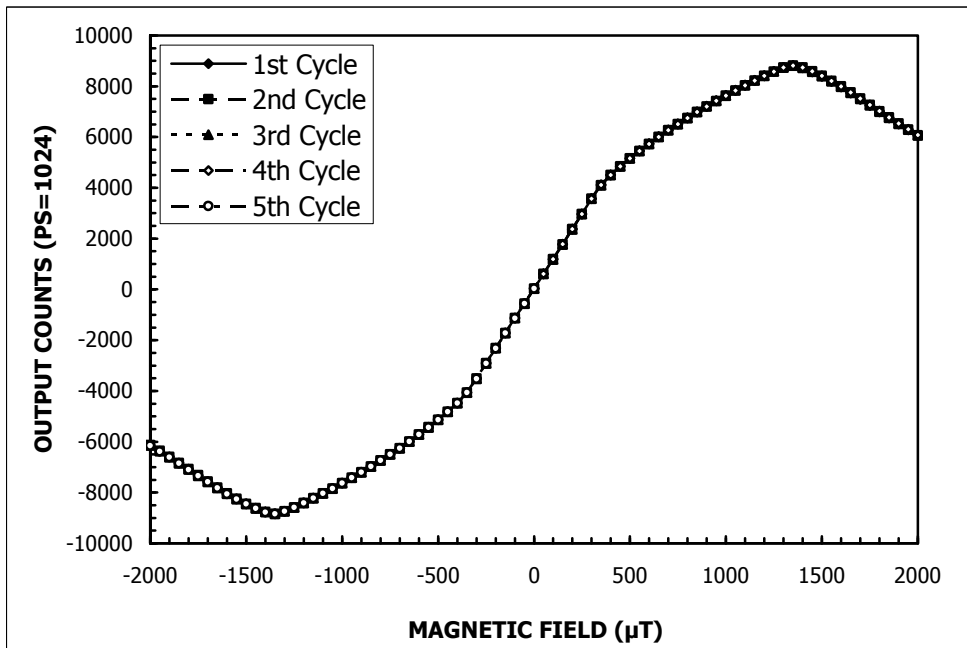

Figure 5: Dynamic Range, $\pm 2000 \mu\text{T}$ at 3V

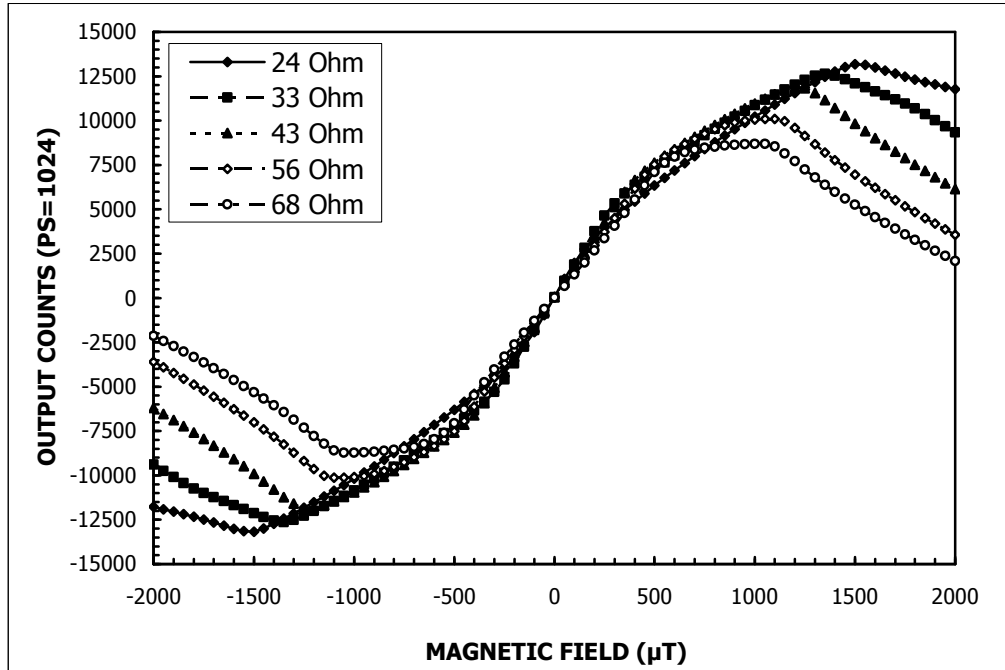
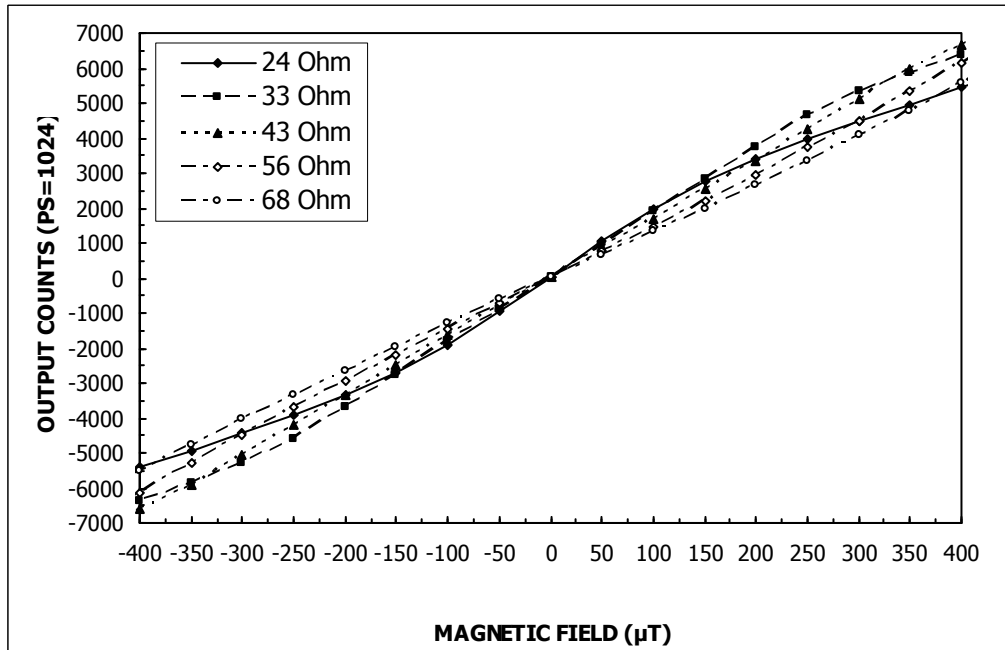
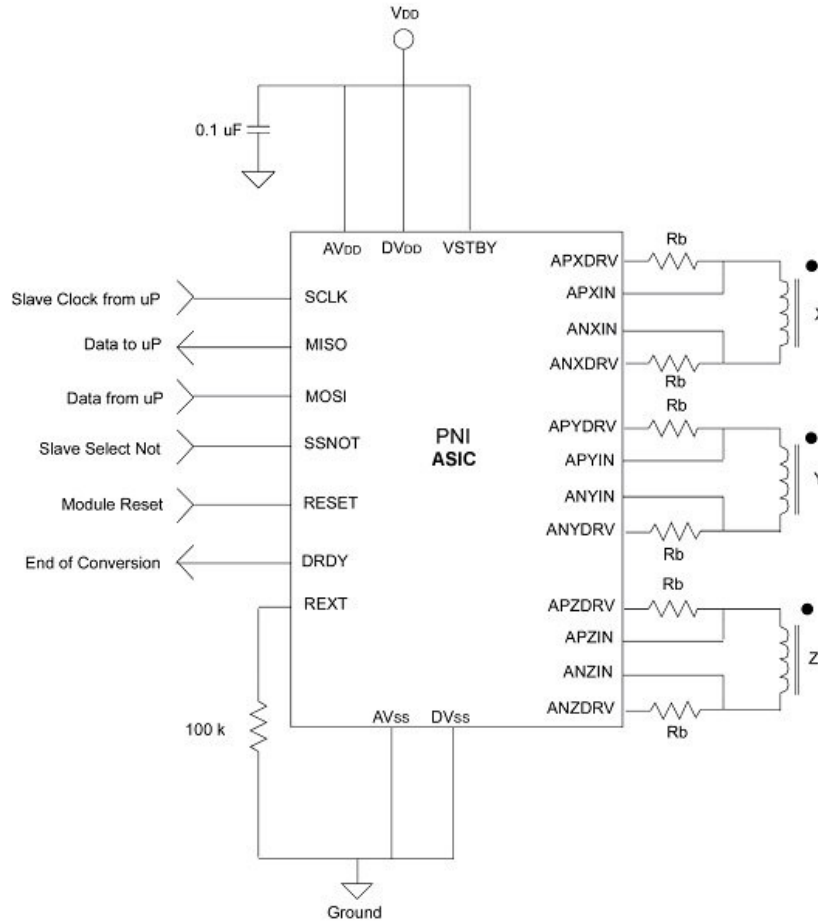

Figure 6: Linearity over Typical Operating Range, $\pm 300 \mu\text{T}$ at 3V



Recommended Circuit Block Diagram

Figure 7: ASIC Circuit Diagram



Rb is dependent on the supply voltage:

5 VDC: $R_b = 68\Omega$

3 VDC: $R_b = 43\Omega$

For more information see the PNI ASIC datasheet.

Figure 8: ASIC Connections Relative to Sensor Axis

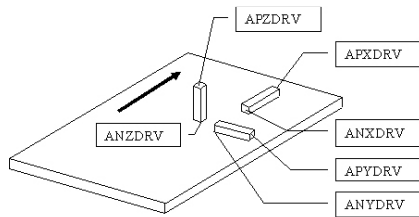

Package Information

Sensor Dimensions

Unless otherwise specified

- Bracket dimensions [x.xx] in mm, non-bracketed in inches
- Tolerances are ± 0.05 mm

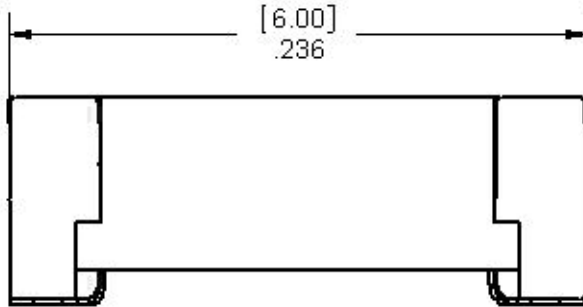

Figure 9: Front View

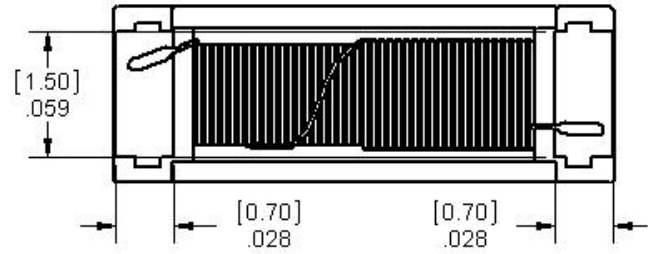

Figure 10: Bottom View

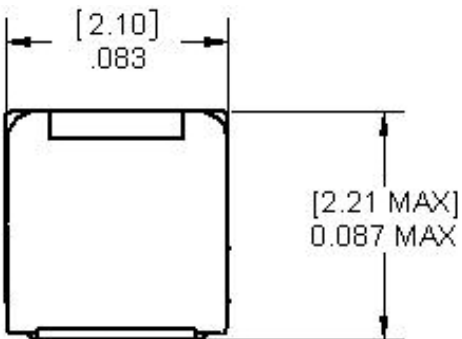

Figure 11: End View

Sensor Dimensions

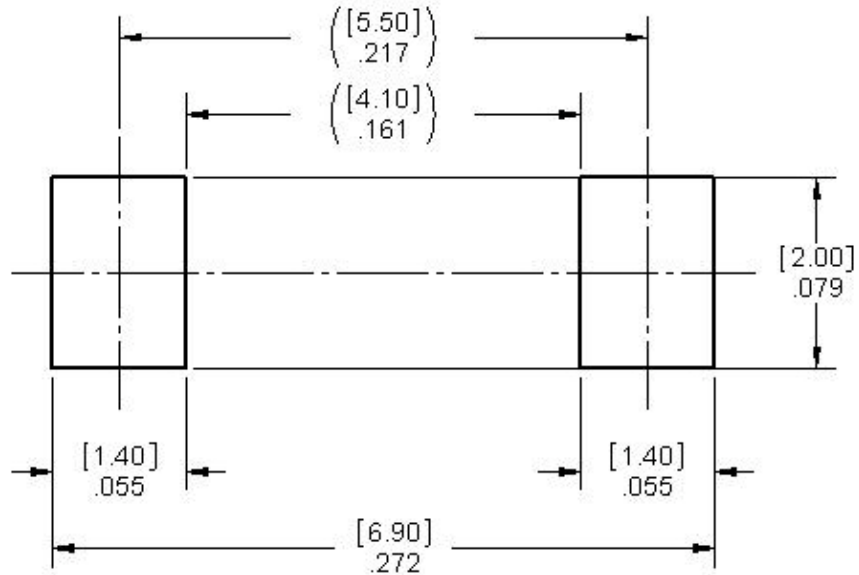

Figure 12: Pad Layout

Tape & Reel Information

Unless otherwise specified :

- All measurements in millimeters
- Tolerances are ± 0.1 mm

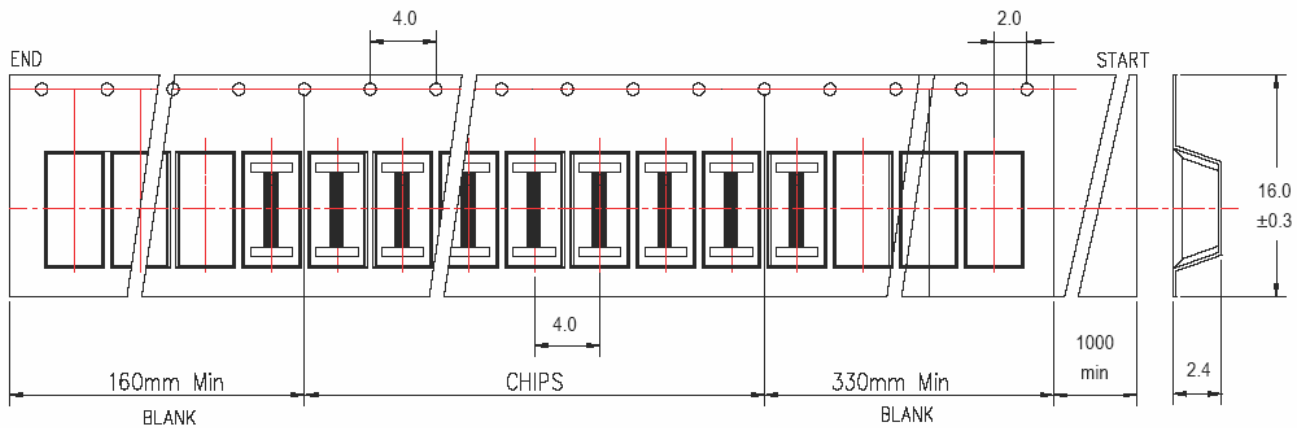

Figure 13: SEN-R Tape Dimensions

Full reel is 5,000 pcs. Smaller quantities on cut-tape.
Tape & Reel meets ANSI/EIA standard EIA-418-B

Recommended Processing Parameters

Figure 14: Reflow Profile

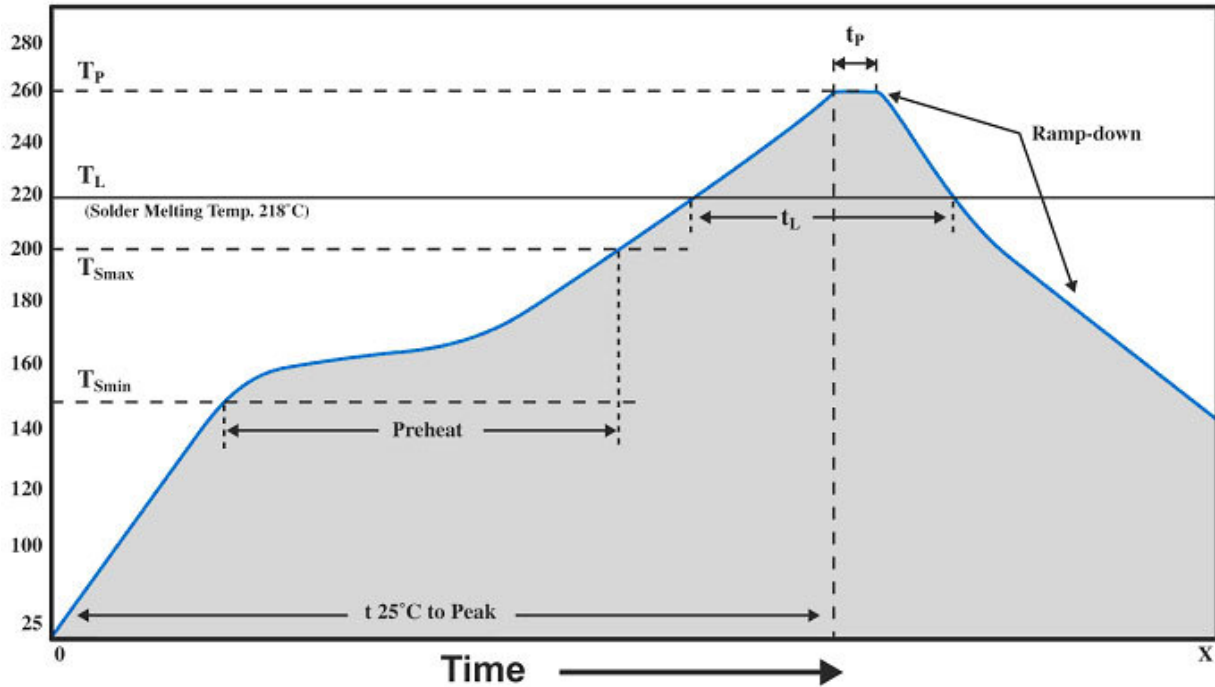

Table 6: Recommended Processing Parameters^a

| REFLOW PARAMETER | TEMPERATURE (°C) | TIME (SEC) |
|---|------------------|------------|
| Preheat Temperature (T_{smin} To T_{smax}) | 150°C – 200°C | 60-180 |
| Temperature T_l (Typical Solder Melting Point) | >218°C | |
| T_{smax} To T_l Ramp-Up Rate | 3°C/Second Max | |
| Peak Temperature T_p | <260°C | |
| Time 25°C To Peak T_p | 6 Minute Max | |
| Time Maintained Above Temperature T_l (T_l) | 218°C | 60-120 |
| Soak (Time Within 5° Of Actual Peak T_p) | | 10-20 |
| Rampdown Rate | 4°C/Second Max | |

a. Meets IPC/JEDEC J-STD-020 profile recommendations