

OKI electronic components

KGF1531

Small-Signal Amplifier

GENERAL DESCRIPTION

The KGF1531 is a high-performance GaAs FET small-signal dual-gate mixer for L-band frequencies that features low voltage operation, low current operation, high conversion gain, and low distortion. The KGF1531 specifications are guaranteed to a fixed matching circuit for 3 V and 1.9 GHz; external impedance-matching circuits are also required. Because of the high 3rd-order intercept point, the KGF1531 is ideal as a small-signal receiving mixer for L-band personal handy phones, such as digital keying cordless phones that require low intermodulation properties.

FEATURES

- Low voltage and low current operation: 3 V, 8 mA (max.)
- Specifications guaranteed as the mixer operation to a fixed matching circuits for 3 V, 1.9 GHz
- High conversion gain: 12 dB (typ.) at 1.9 GHz
- Low distortion: 3rd-order intercept point = 12.5 dBm (typ.) at 1.9 GHz
- Self-bias circuit configuration with built-in source capacitor
- Package: 4PSOP

PACKAGE DIMENSIONS

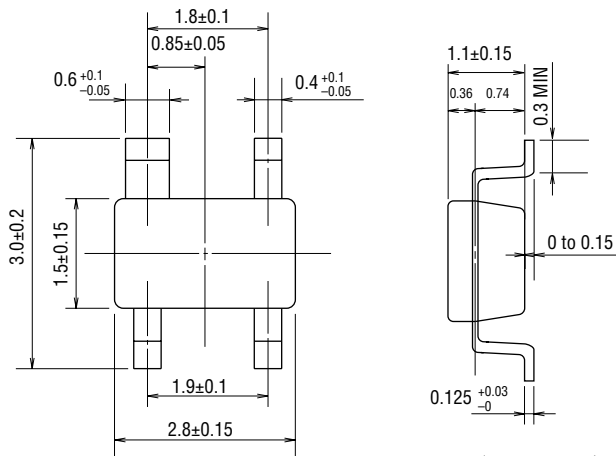

(Unit: mm)

Package material	Epoxy resin
Lead frame material	42 alloy
Pin treatment	Solder plating
Solder plate thickness	5 μm or more

MARKING

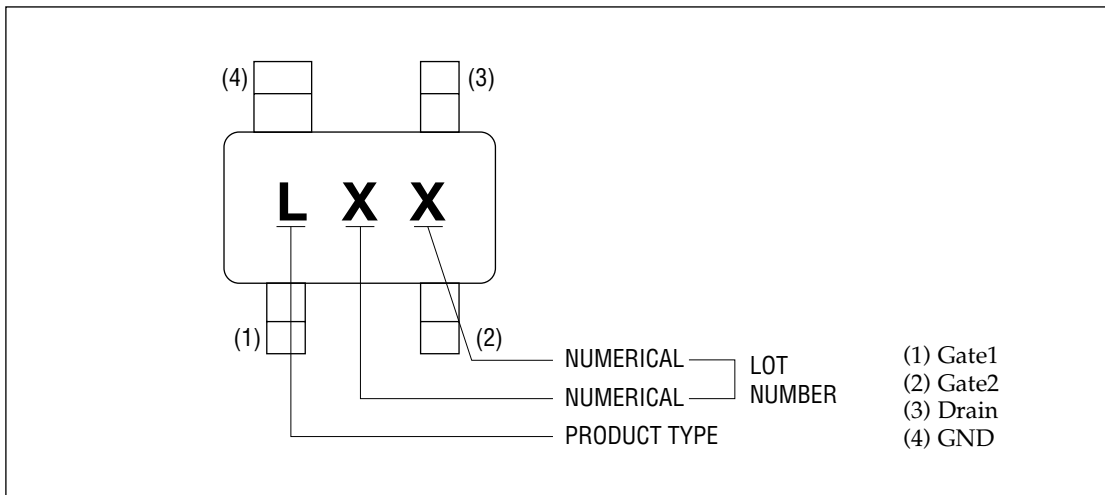

CIRCUIT

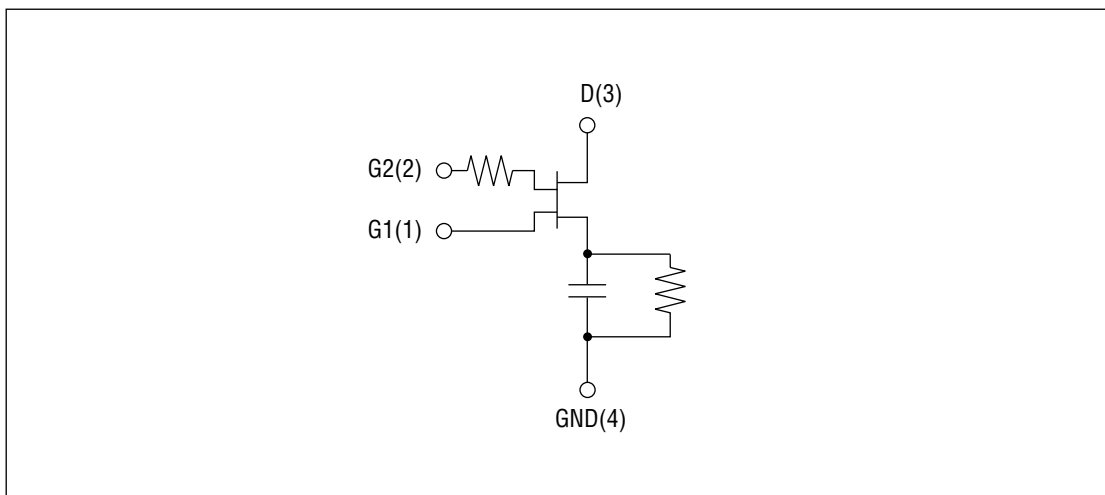

ABSOLUTE MAXIMUM RATINGS

Item	Symbol	Condition	Unit	Min.	Max.
Drain-source voltage	V_{DS}	$T_a = 25^\circ\text{C}$	V	—	4.0
Gate-source voltage	V_{GS}	$T_a = 25^\circ\text{C}$	V	-3.0	0.4
Drain current	I_{DS}	$T_a = 25^\circ\text{C}$	mA	—	50
Total power dissipation	P_{tot}	$T_a = 25^\circ\text{C}$	mW	—	200
Channel temperature	T_{ch}	—	$^\circ\text{C}$	—	150
Storage temperature	T_{stg}	—	$^\circ\text{C}$	-45	125

ELECTRICAL CHARACTERISTICS

(Ta = 25°C)

Item	Symbol	Condition	Unit	Min.	Typ.	Max.
Gate-source leakage current	I_{GSS}	$V_{GS} = -3\text{ V}$	μA	—	—	30
Gate-drain leakage current	I_{GDO}	$V_{GD(1,2)} = -6\text{ V}$	μA	—	—	30
Drain-source leakage current	$I_{DS(off)}$	$V_{DS} = 3\text{ V}, V_{GS(1,2)} = -2\text{ V}$	μA	—	—	30
Drain current	I_{DSS}	$V_{DS} = 3\text{ V}, V_{GS} = 0\text{ V}$	mA	15	25	—
Operating current	I_D	(*1), $P_{IN} = -20\text{ dBm}$	mA	—	6.0	8.0
Gate-source cut-off voltage	$V_{GS(off)}$	$V_{DS} = 3\text{ V}, I_{DS} = 100\ \mu\text{A}$	V	-1.4	—	-0.6
Transconductance	g_m	$V_{DS} = 3\text{ V}, I_{DS} = 6\text{ mA}$	mS	23	30	—
Noise figure	F	(*1)	dB	—	5.0	—
Conversion gain	G_C	(*1), $P_{RF} = -20\text{ dBm}$	dB	10	12	—
Output power	P_{O1}	(*1)	dBm	0	1.0	—
Port to port Isolation	L-R	ISO	(*1), $P_{RF} = -20\text{ dBm}$	dB	15	—
	R-I				22	
	L-I				28	
Third-order intercept point	IP_3	(*2), $f_2 = 1.901\text{ GHz}$	dBm	—	12.5	—

*1 Self-bias condition: $V_{DD} = 3\text{ V} \pm 0.3\text{ V}$, $V_{G(1,2)} = 0\text{ V}$, $f_{RF} = 1.9\text{ GHz}$, $f_{LO} = 1.65\text{ GHz}$, $P_{LO} = 0\text{ dBm}$

RF CHARACTERISTICS

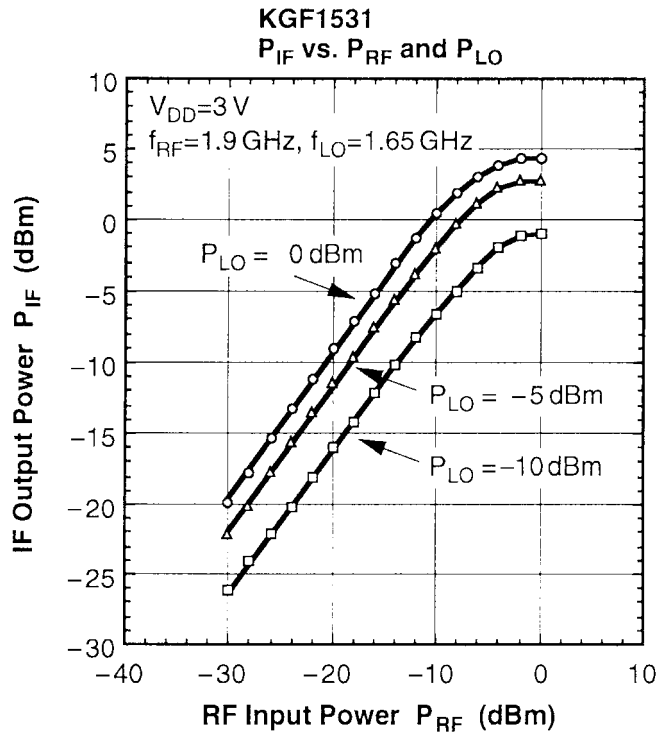
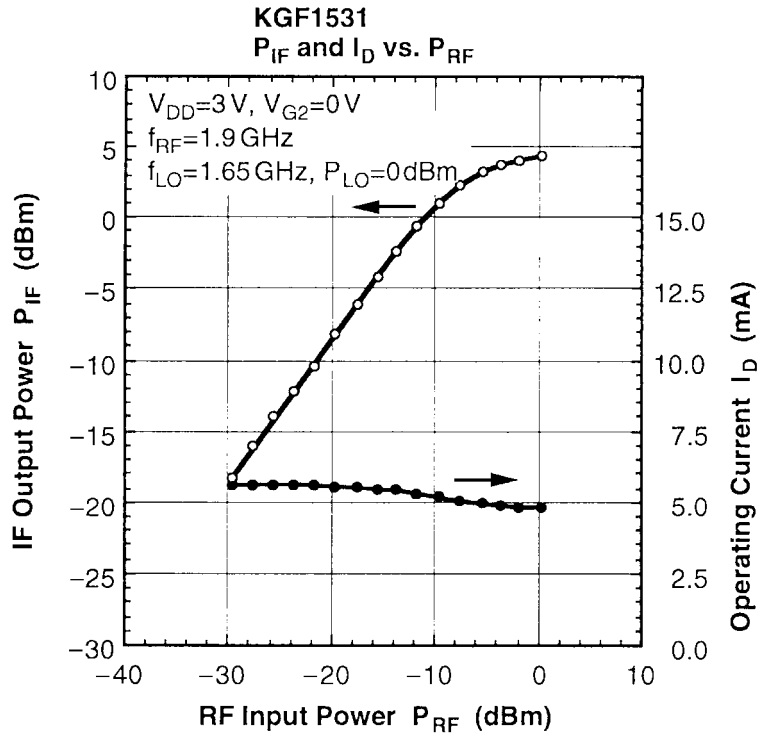

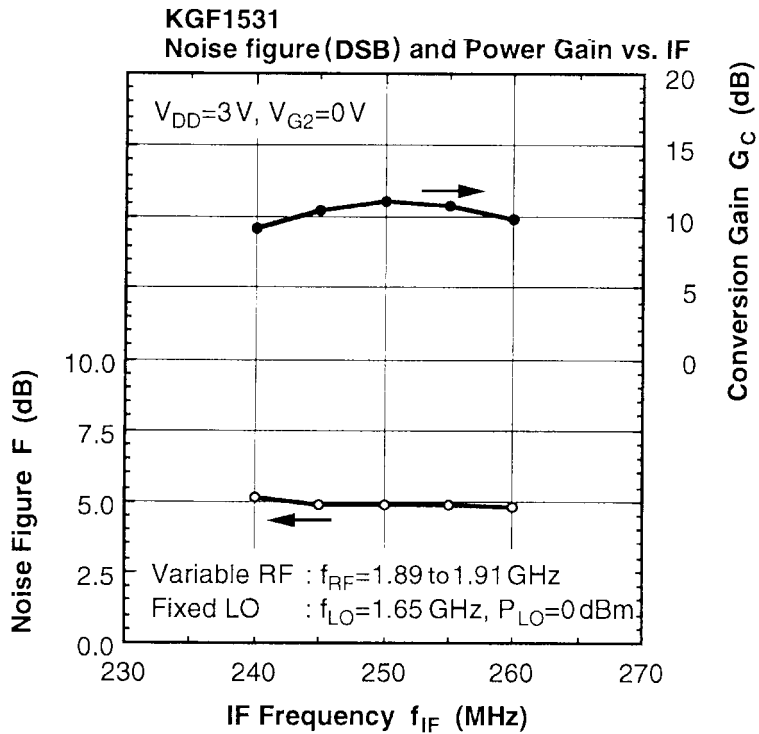
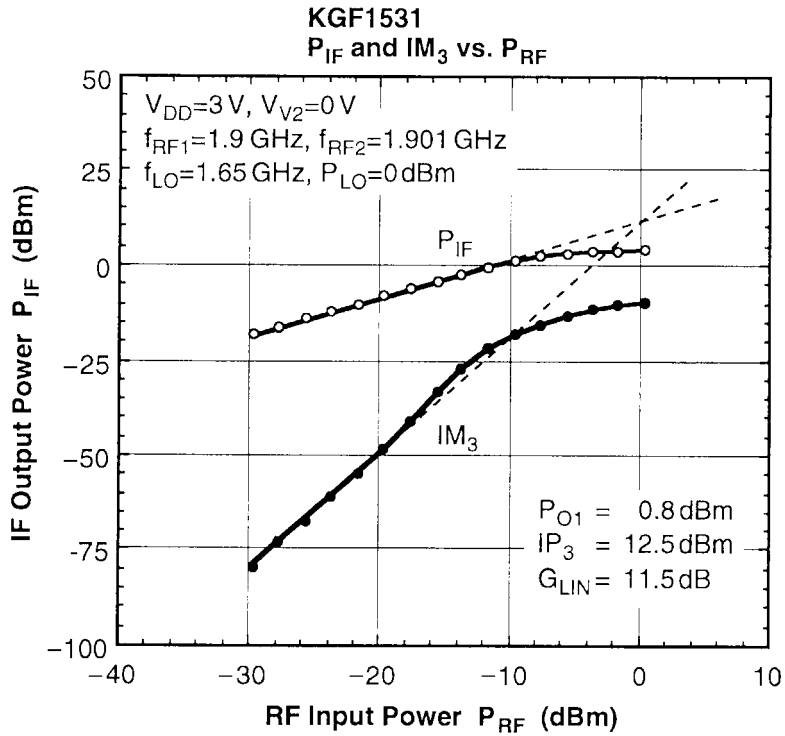

Typical S Parameters

 $V_{DD} = 3\text{ V}$, $V_{G2} = 0\text{ V}$, $I_D = 6.13\text{ mA}$

Freq(MHz)	MAG(S ₁₁)	ANG(S ₁₁)	MAG(S ₂₁)	ANG(S ₂₁)	MAG(S ₁₂)	ANG(S ₁₂)	MAG(S ₂₂)	ANG(S ₂₂)
100.0	1.002	-2.06	0.485	-156.45	0.001	134.30	0.973	-1.54
200.0	1.006	-4.21	0.660	-163.21	0.001	89.30	0.963	-2.43
300.0	1.003	-6.32	0.735	-171.52	0.002	49.34	0.959	-3.20
400.0	1.003	-8.72	0.777	-178.89	0.004	67.00	0.954	-4.02
500.0	1.005	-10.85	0.804	175.03	0.004	76.91	0.952	-4.71
600.0	0.999	-13.27	0.821	170.22	0.003	77.54	0.953	-5.26
700.0	0.996	-15.36	0.824	164.84	0.005	61.41	0.950	-6.06
800.0	0.995	-17.66	0.838	160.75	0.004	76.89	0.947	-6.90
900.0	0.992	-19.96	0.854	156.05	0.005	59.09	0.950	-7.42
1000.0	0.987	-22.12	0.858	152.38	0.006	62.64	0.947	-8.21
1100.0	0.983	-24.16	0.868	148.70	0.004	62.28	0.949	-8.92
1200.0	0.979	-26.53	0.882	144.57	0.004	67.53	0.948	-9.94
1300.0	0.977	-28.56	0.894	141.09	0.004	71.94	0.951	-10.48
1400.0	0.972	-31.19	0.906	137.65	0.003	88.94	0.950	-11.45
1500.0	0.970	-33.26	0.921	133.84	0.007	107.44	0.950	-12.14
1600.0	0.963	-35.49	0.933	130.62	0.004	76.87	0.950	-13.12
1700.0	0.959	-37.73	0.945	127.43	0.006	74.93	0.950	-13.80
1800.0	0.953	-40.11	0.967	123.66	0.005	106.06	0.948	-14.62
1900.0	0.947	-42.58	0.981	120.52	0.005	104.31	0.947	-15.36
2000.0	0.940	-44.82	0.999	116.72	0.006	128.87	0.948	-16.33
2100.0	0.922	-47.03	1.017	112.95	0.006	106.36	0.949	-17.37
2200.0	0.927	-49.42	1.029	110.02	0.006	115.80	0.948	-17.95
2300.0	0.925	-51.84	1.064	106.74	0.006	153.54	0.948	-18.82
2400.0	0.913	-54.35	1.081	103.70	0.009	152.18	0.949	-19.59
2500.0	0.900	-57.14	1.091	99.12	0.012	137.58	0.949	-20.37
2600.0	0.891	-59.49	1.121	96.98	0.012	146.84	0.952	-21.07
2700.0	0.880	-62.22	1.152	93.75	0.013	150.18	0.957	-22.18
2800.0	0.874	-64.94	1.196	90.37	0.015	151.42	0.950	-22.78
2900.0	0.863	-66.98	1.227	87.35	0.015	158.84	0.957	-24.27
3000.0	0.851	-70.00	1.277	83.46	0.021	149.86	0.955	-24.83

Typical S Parameters

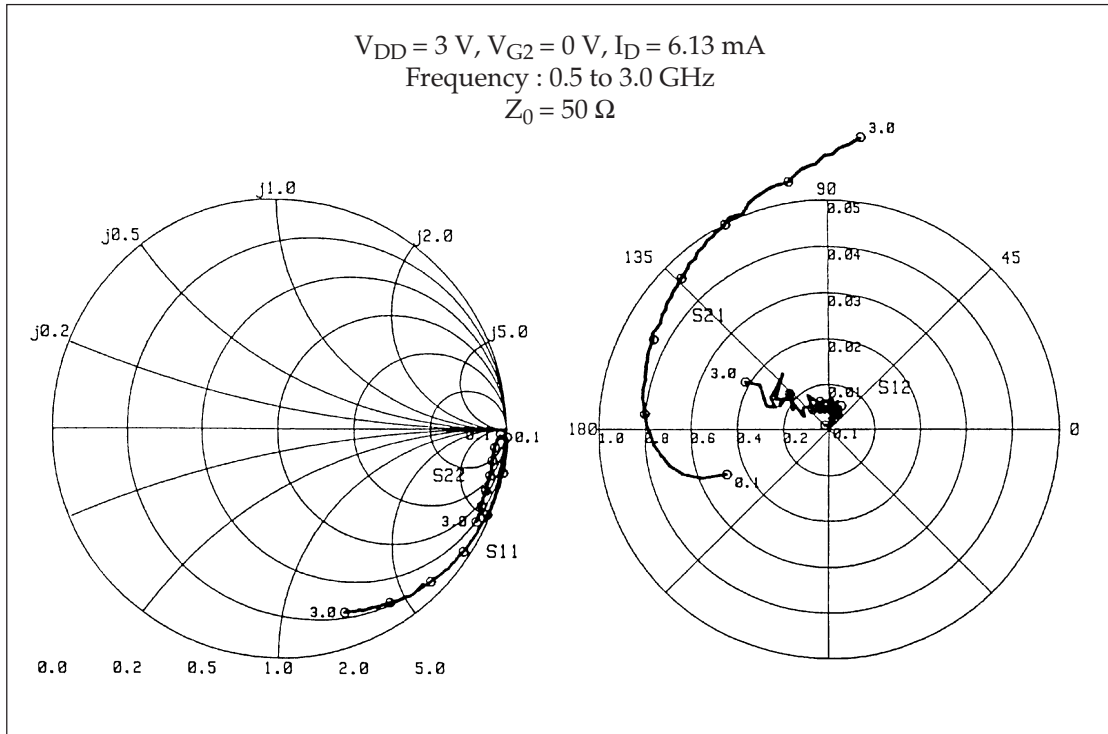

Test Circuit and Bias Configuration for KGF1531

