

# OKI electronic components

---

## OCM2□2, 2□3 SERIES

---

### Low ON-resistance Type Optical MOS Relay For AC/DC Load

---

#### GENERAL DESCRIPTION

The OCM2□2 and OCM2□3 Series are optical MOS relays for AC/DC load. The input portion is an infrared light emitting diode. The output portion uses a combination of VD-MOS (Vertical Diffusion MOS) FETs and photodiode arrays. The device is encased in an extremely small 6-pin plastic DIP or SMD-type (gull-wing) package.

The optical MOS relay switch may be used in applications that currently use mechanical relay switches, but offers smaller size, noise-free switching, and electronic circuit compatibility because of its non-mechanical operation. Optical MOS relay switches also dissipate less power than equivalent bipolar devices at lower switching frequencies.

#### FEATURES

- Infinitesimally small control voltage
- High reliability due to non-contact and optical operation
- No chattering or switch bounces
- No mechanical switching noises
- Small size and easy mounting (6-pin plastic DIP or SMD-type[gull-wing] package)

#### APPLICATIONS

- Telecommunications equipment
- Measurement equipment
- Home electronics
- Automatic meter reading equipment
- Other applications requiring small size or high performance
- Other applications requiring non-contact switches

PIN CONFIGURATION

(Unit: mm)

• DIP Type

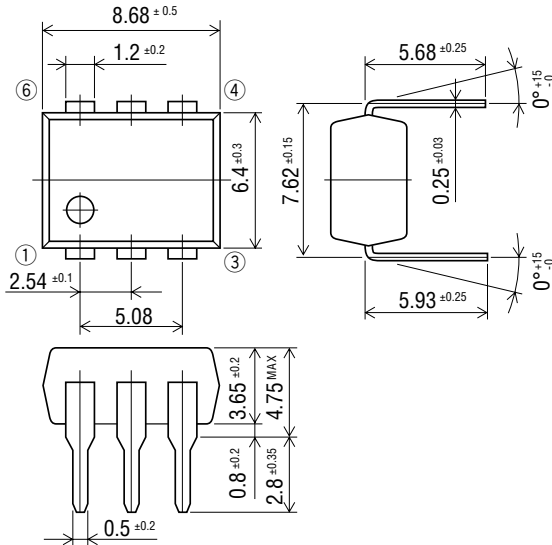

• Through hole (Bottom view)

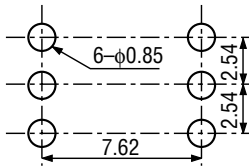

• Pin Connection Diagram

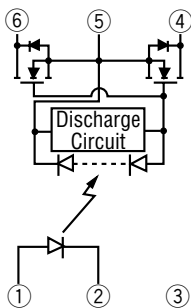

- 1: Anode (LED)
- 2: Cathode (LED)
- 3: NC
- 4: Drain (MOS FET)
- 5: Source (MOS FET)
- 6: Drain (MOS FET)

• SMD Type (gull-wing)

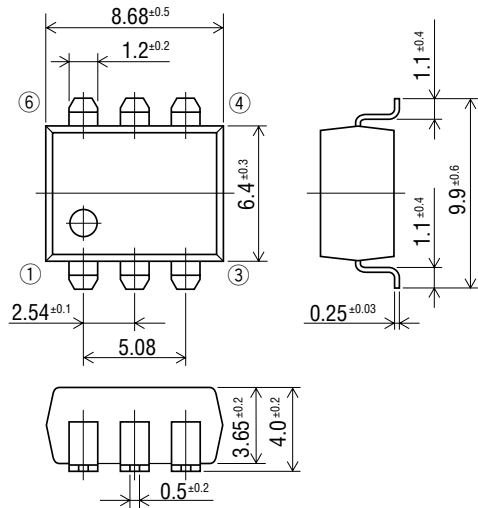

• Mounting pad (Top view)

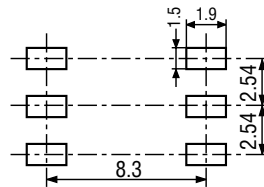

## ABSOLUTE MAXIMUM RATINGS

(Ambient temperature Ta=25°C)

Product Name				OCM202	OCM212	OCM222	OCM242
Parameter	Symbol	Condition	Unit	OCM203	OCM213	OCM223	OCM243
Input Characteristics	Continuous Forward Current	$I_F$		mA			
	Derating Factor of Continuous Forward Current	$\Delta I_F$		mA/°C			
	Peak Forward Current	$I_{FM}$	Pulse width 100 $\mu$ s Cycle 10 ms	A			
	Reverse Voltage	$V_R$		V			
	Power Dissipation	$P_{DL}$		mW			
Output Characteristics	Load Voltage	$V_{OFF}$		60	100	200	400
	Load Current	$I_{ON}$		400	350	250	150
	Derating Factor of Load Current	$\Delta I_{ON}$		mA/°C			
	Surge Load Current	$I_{SUG}$	Pulse width 1 ms 1shot	A			1.5
	Total Power Dissipation	$P_D$		mW			
	Total Power Dissipation	$P_{tot}$		mW			
Isolation Voltage	$V_{IO}$		V(rms)	1500			
				OCM202	OCM212	OCM222	OCM242
				4000			
				OCM203	OCM213	OCM223	OCM243
Operating Temperature	$T_{opr}$		°C	-40 to +85			
Storage Temperature	$T_{stg}$		°C	-40 to +100			

## ELECTRICAL CHARACTERISTICS

(Ambient temperature Ta=25°C)

Product Name						OCM202	OCM212	OCM222	OCM242
Parameter	Symbol	Condition		Unit	OCM203	OCM213	OCM223	OCM243	
Input Characteristics	Forward Voltage	V <sub>F</sub>	I <sub>F</sub> =10 mA	Min.	V	1.0			
				Max.		1.3			
	Reverse Current	I <sub>R</sub>	V <sub>R</sub> =5 V	Max.	μA	10			
	Operation Input Current *1	I <sub>FA</sub>	I <sub>ON</sub> =100 mA	Max.	mA	5			
Recovery Input Current	I <sub>FR</sub>	V <sub>OFF</sub> =Rating I <sub>ON</sub> =100 μA	Min.	mA	0.2				
Output Characteristics	On-resistance	R <sub>ON</sub>	I <sub>F</sub> =10 mA I <sub>ON</sub> =100 mA <small>Time to flow current is within one second</small>	Min.	Ω	0.4	0.6	2.0	6.0
				Typ.		0.9	1.3	3.0	9.0
				Max.		1.5	2.0	4.0	12.5
Off-state Leakage Current*2	I <sub>OFF</sub>	V <sub>OFF</sub> =Rating	Max.	μA	1.0				
Output Terminal Capacitance	C <sub>OUT</sub>	V <sub>OFF</sub> =50 V f=1 MHz	Typ.	pF	70	50	35	25	
Input-to-output Capacitance	C <sub>IO</sub>	f=1 MHz	Typ.	pF	1.3				
Coupling Characteristics	Turn-on Time *3	t <sub>ON</sub>	I <sub>F</sub> =10 mA	Typ.	ms	0.3			
				Max.		1.0			
	Turn-off Time *3	t <sub>OFF</sub>	I <sub>ON</sub> =100 mA	Typ.	ms	0.2			
				Max.		1.0			

\*1 : Can correspond to special specification I<sub>FA</sub><3.0 mA\*2 : Can correspond to special specification I<sub>OFF</sub><1.0 nA\*3 : Can correspond to special specification t<sub>ON</sub>/t<sub>OFF</sub><0.5 ms

TYPICAL CHARACTERISTICS

- Derating Factor of Continuous Forward Current

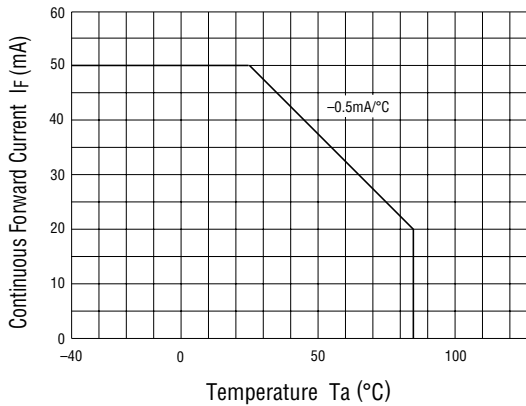

- Derating Factor of Load Current

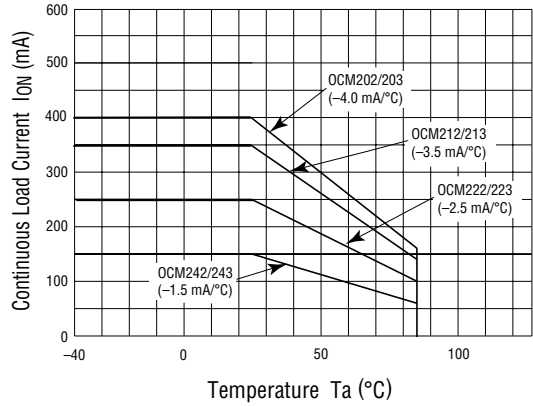

- Operation Input Current vs. Ambient Temperature

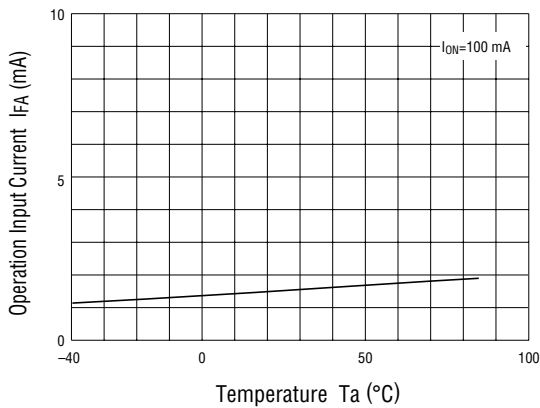

- Recovery Input Current vs. Ambient Temperature

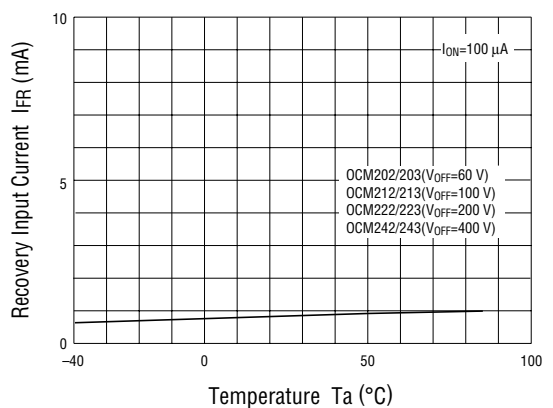

- On-resistance vs. Ambient Temperature 1

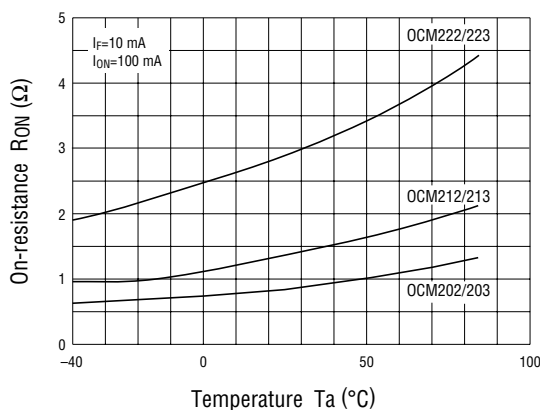

- On-resistance vs. Ambient Temperature 2

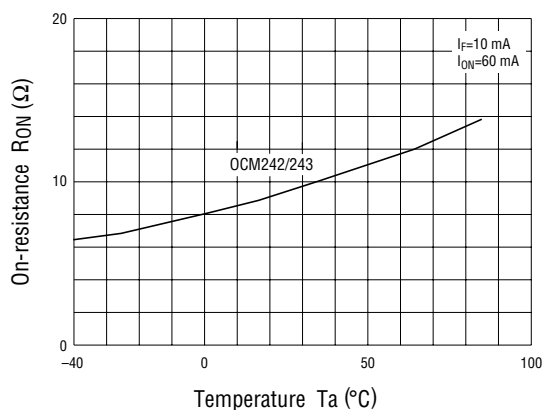

- Turn-on/Turn-off Time vs. Ambient Temperature

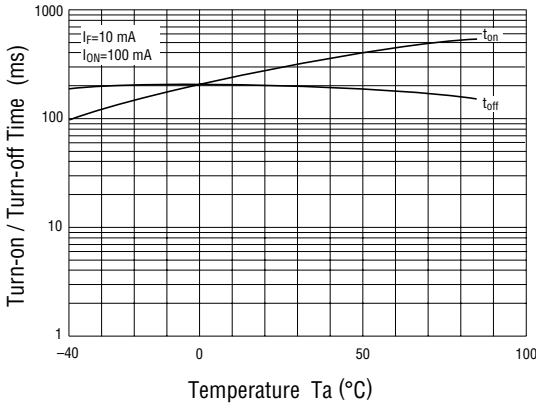

- Off-state Leakage Current vs. Ambient Temperature

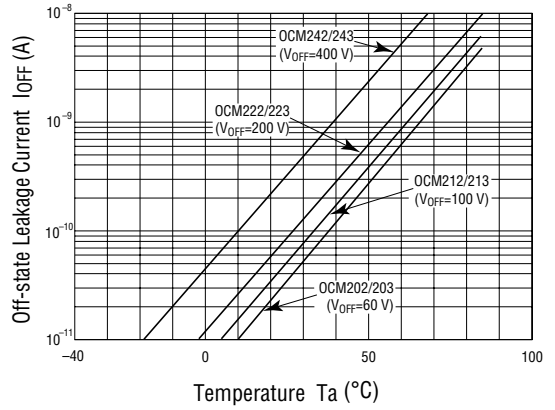

- Continuous Forward Current vs. On-resistance 1

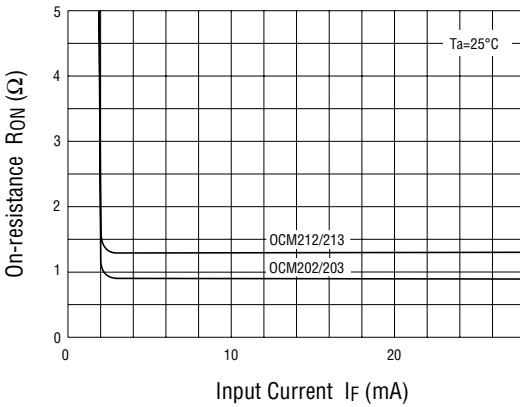

- Continuous Forward Current vs. On-resistance 2

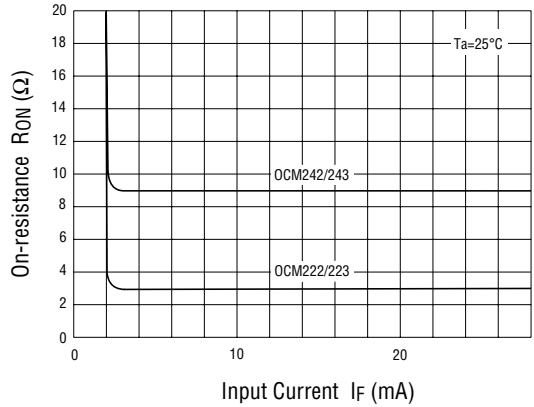

- Continuous Forward Current vs. Turn-on/Turn-off Time

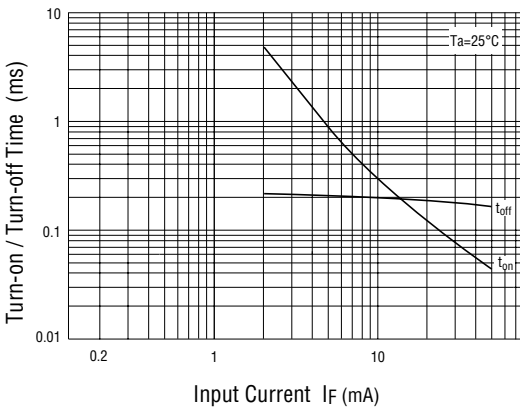

- Output Terminal Capacitance vs. Applied Voltage

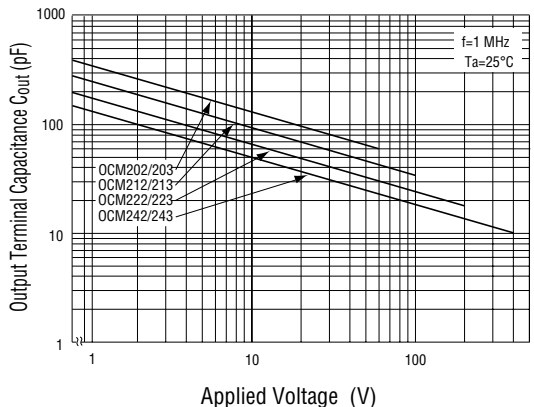

- Load current vs. voltage

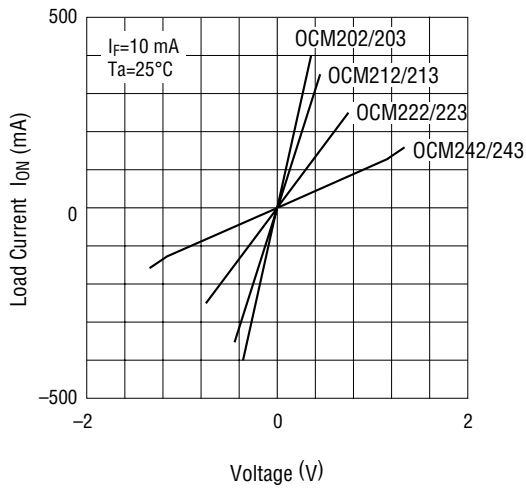

- Example Circuit for Measuring Turn-on/Turn-off Time

