

OKI electronic components

OCMS2□6DP SERIES

Power Saving Dial Pulse SOP Type Optical MOS Relay For AC/DC Load

GENERAL DESCRIPTION

The OCMS2□6DP series is a family of optical MOS relays for AC/DC load. The input portion is an infrared light emitting diode. The output portion uses a combination of VD-MOS (Vertical Diffusion MOS) FETs and photodiode arrays. The device is encased in an extremely small 6-pin plastic SOP type package.

The series reduced its area to 50% and its volume to 27% of the conventional DIP or SMD-type optical MOS relays.

The series is 2.1mm thick and is ideal for modem card applications.

The optical MOS relay switch may be used in applications that currently use mechanical relay switches, but offers smaller size, noise-free switching, and electronic circuit compatibility because of its non-mechanical operation. Optical MOS relay switches also dissipate less power than equivalent bipolar devices at lower switching frequencies.

FEATURES

- Extremely low voltage control
- Thickness of 2.1mm
- High reliability due to non-contact and optical operation
- No chattering or switch bounces
- No mechanical switching noises
- Small size and easy mounting (6-pin plastic SOP package)

APPLICATIONS

- Telecommunications system (such as modem cards)
- Measurement equipment
- Home electronics
- Automatic meter reading equipment
- Other applications requiring small size or high performance
- Other applications requiring non-contact switches

PIN CONFIGURATION

(Unit: mm)

• 6pin SOP Type

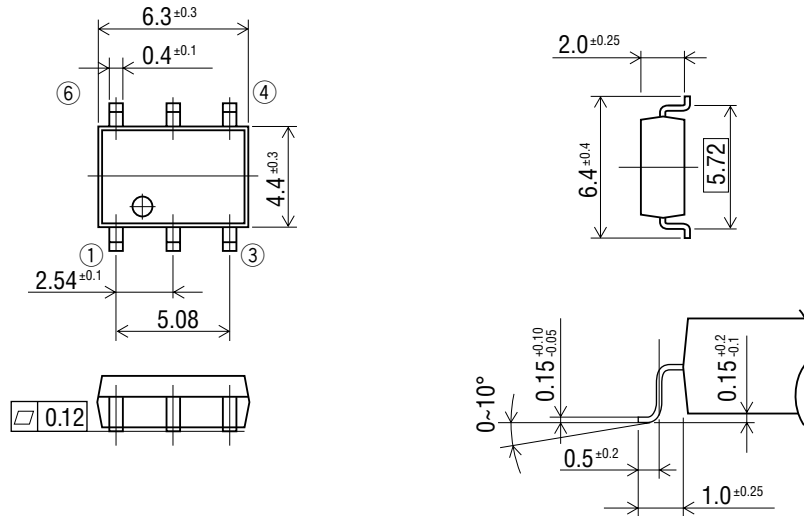

• Mounting pad (Top view)

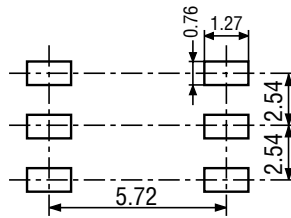

• Pin Connection Diagram

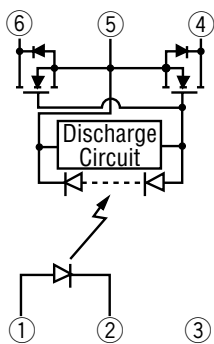

- 1: Anode (LED)
- 2: Cathode (LED)
- 3: NC
- 4: Drain (MOS FET)
- 5: Source (MOS FET)
- 6: Drain (MOS FET)

ABSOLUTE MAXIMUM RATINGS

(Ambient temperature $T_a=25^{\circ}\text{C}$)

Product Name					OCMS236DP	OCMS246DP
Parameter	Symbol	Condition	Unit			
Input Characteristics	Continuous Forward Current	I_F		mA	50	
	Derating Factor of Continuous Forward Current	ΔI_F		mA/°C	Refer to [Derating Factor of Continuous Forward Current] of characteristics data	
	Peak Forward Current	I_{FM}	Pulse width 100 μs Cycle 10 ms	A	0.5	
	Reverse Voltage	V_R		V	5	
	Power Dissipation	P_{DL}		mW	75	
Output Characteristics	Load Voltage	V_{OFF}		V	350	400
	Load Current	I_{ON}		mA	140*	120*
	Derating Factor of Load Current	ΔI_{ON}		mA/°C	Refer to [Derating Factor of Load Current] of characteristics data	
	Surge Load Current	I_{SUG}	Pulse width 1 ms 1shot	A	0.8	0.7
	Power Dissipation	P_D		mW	300	
	Total Power Dissipation	P_{tot}		mW	325	
Isolation Voltage	V_{IO}		V(rms)	1500		
Operating Temperature	T_{opr}		°C	-40 to +85		
Storage Temperature	T_{stg}		°C	-40 to +100		

* : Load current when mounted on a board. Please contact our sales personnel for detail.

ELECTRICAL CHARACTERISTICS

(Ambient temperature $T_a=25^\circ\text{C}$)

Product Name					OCMS236DP	OCMS246DP
Parameter	Symbol	Condition	Unit			
Input Characteristics	Forward Voltage	V_F	$I_F=10\text{ mA}$	Min.	V	1.0
				Max.		1.3
	Reverse Voltage	I_R	$V_R=5\text{ V}$	Max.	μA	10
	Operation Input Current	I_{FA}	$I_{ON}=100\text{ mA}$	Max.	mA	0.5
Recovery Input Current	I_{FR}	$V_{OFF}=\text{Rating}$ $I_{ON}=100\ \mu\text{A}$	Min.	mA	0.02	
Output Characteristics	On-resistance	R_{ON}	$I_F=10\text{ mA}$ $I_{ON}=100\text{ mA}$ <small>Time to flow current is within one second</small>	Min.	Ω	7.0
				Typ.		17
				Max.		24
Off-state Leakage Current	I_{OFF}	$V_{OFF}=\text{Rating}$	Max.	μA	1.0	
Output Terminal Capacitance	C_{OUT}	$V_{OFF}=50\text{ V}$ $f=1\text{ MHz}$	Typ.	pF	12	10
Input-to-output Capacitance	C_{IO}	$f=1\text{ MHz}$	Typ.	pF	1.3	
Coupling Characteristics	Turn-on Time	t_{ON}	$I_F=2\text{ mA}$	Typ.	ms	—
				Max.		1.25
	Turn-off Time	t_{OFF}	$I_{on}=50\text{ mA}$	Typ.	ms	—
				Max.		0.5

TYPICAL CHARACTERISTICS

- Derating Factor of Continuous Forward Current

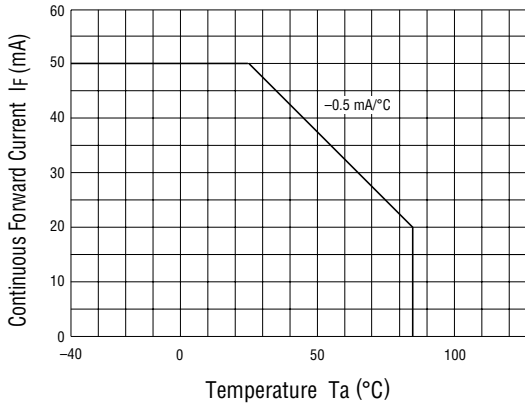

- Derating Factor of Load Current

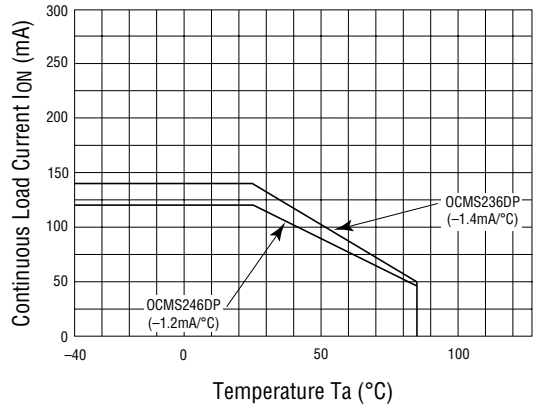

- Operation Input Current vs. Ambient Temperature

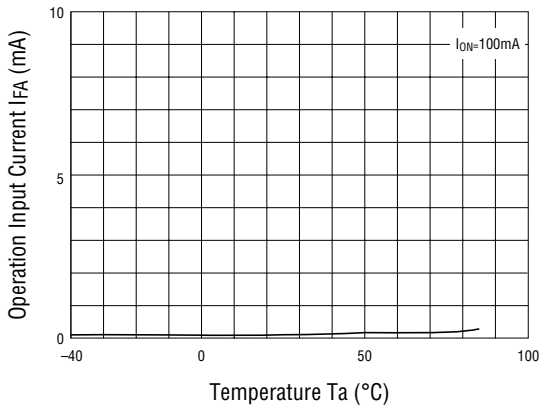

- Recovery Input Current vs. Ambient Temperature

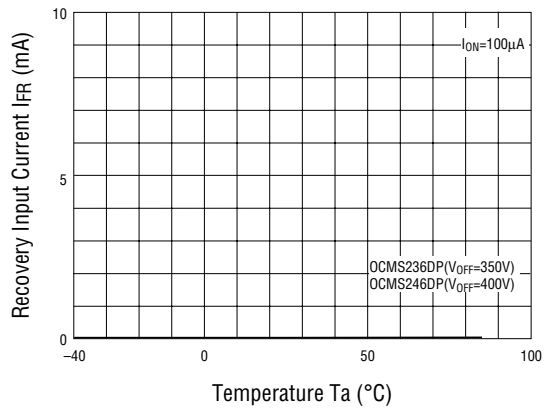

- Continuous forward current vs. On-resistance 1

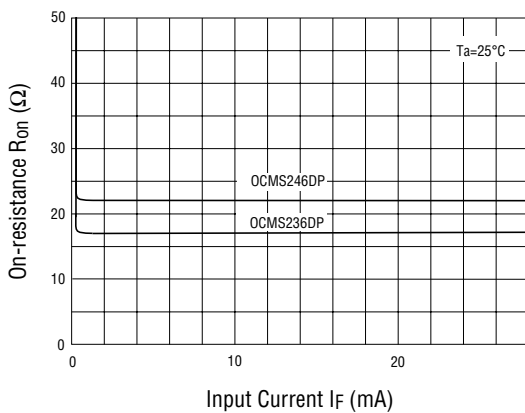

- On-resistance vs. Ambient Temperature 2

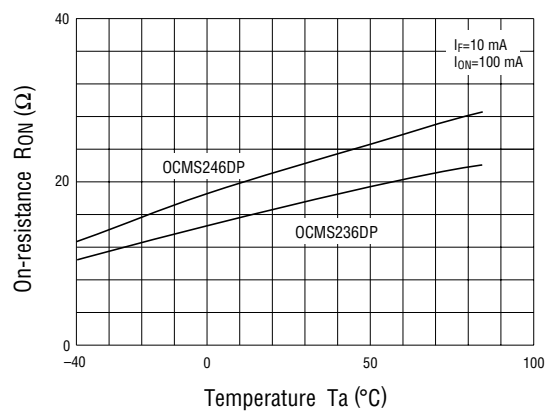

- Turn-on/Turn-off Time vs. Ambient Temperature

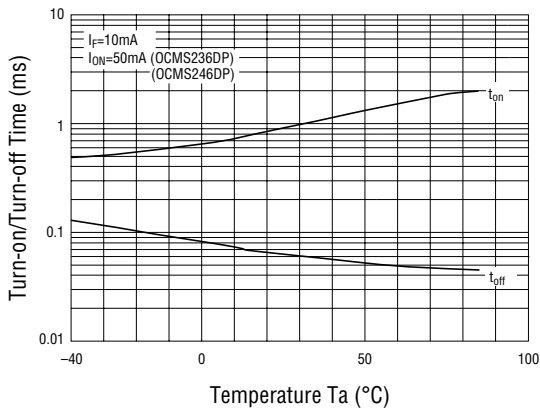

- Off-state Leakage Current vs. Ambient Temperature

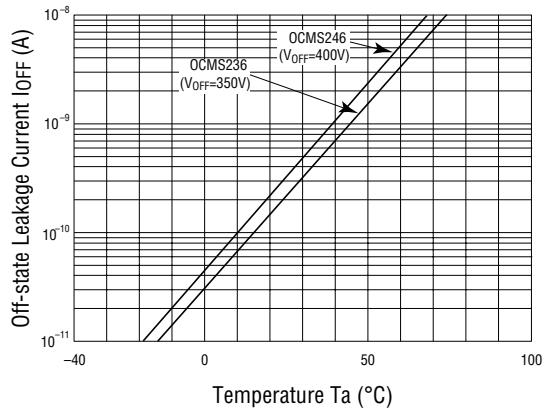

- Continuous Forward Current vs. Turn-on/Turn-off Time

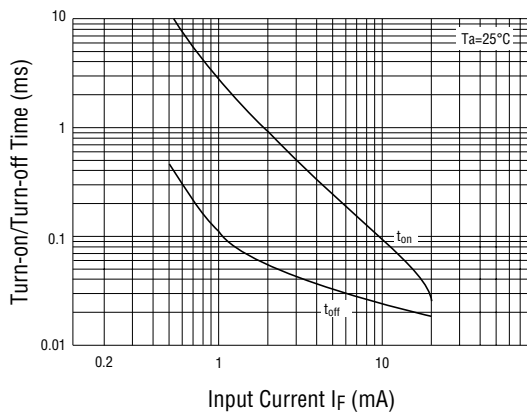

- Output Terminal Capacitance vs. Applied Voltage

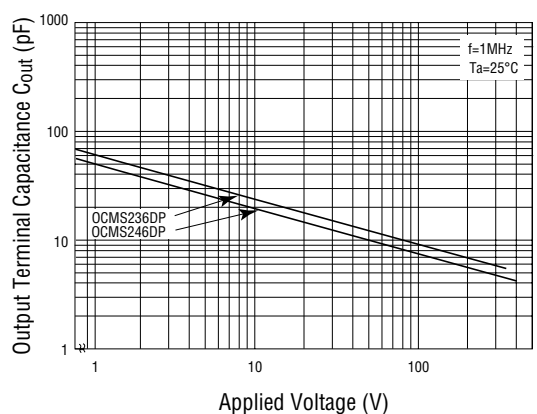

• Load Current vs. Voltage

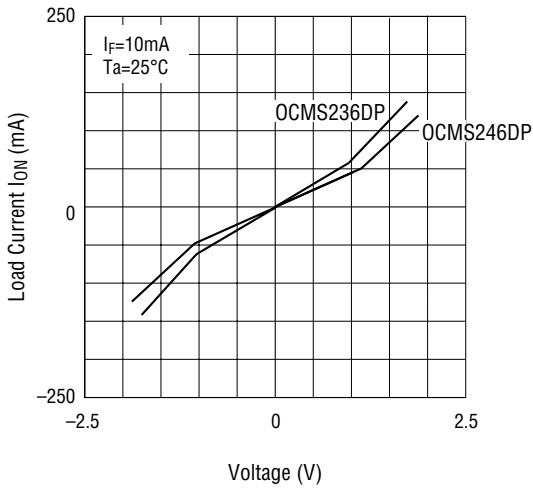

• Example Circuit for Measuring Turn-on/Turn-off Time

