



MMIC VCO w/ HALF FREQUENCY OUTPUT 7.3 - 8.2 GHz

Typical Applications

Low noise MMIC VCO w/Half Frequency, for:

- VSAT Radio
- Point to Point/Multi-Point Radio
- Test Equipment & Industrial Controls
- Military End-Use

Features

- Dual Output: $F_o = 7.3 - 8.2 \text{ GHz}$
 $F_o/2 = 3.65 - 4.1 \text{ GHz}$
- Pout: +15.0 dBm
- Phase Noise: -116 dBc/Hz @100 kHz Typ.
- No External Resonator Needed
- 32 Lead Ceramic 5x5mm SMT Package: 25mm²

Functional Diagram

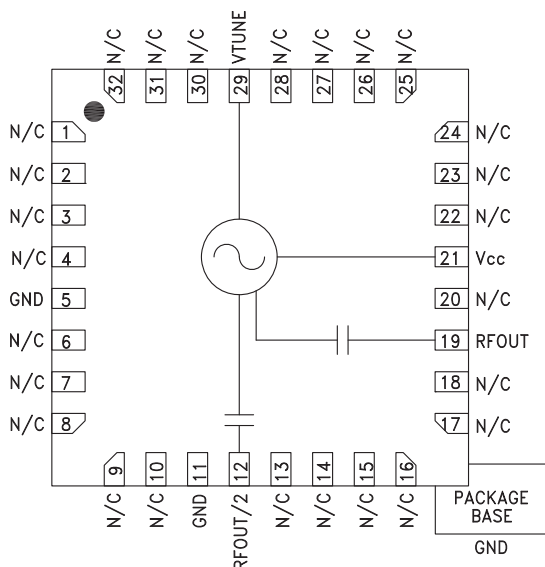

General Description

The HMC508LP5 & HMC508LP5E are GaAs InGaP Heterojunction Bipolar Transistor (HBT) MMIC VCOs. The HMC508LP5 & HMC508LP5E integrate resonators, negative resistance devices, varactor diodes and feature a half frequency output. The VCO's phase noise performance is excellent over temperature, shock, and process due to the oscillator's monolithic structure. Power output is +15 dBm typical from a +5V supply. The voltage controlled oscillator is packaged in a leadless QFN 5x5 mm surface mount package, and requires no external matching components.

Electrical Specifications, $T_A = +25^\circ \text{C}$, $V_{cc} = +5\text{V}$

Parameter	Min.	Typ.	Max.	Units	
Frequency Range	F_o $F_o/2$	7.3 - 8.2 3.65 - 4.1		GHz GHz	
Power Output	RFOUT RFOUT/2	+12 +4	+17 +10	dBm dBm	
SSB Phase Noise @ 100 kHz Offset, $V_{tune} = +5\text{V}$ @ RFOUT		-116		dBc/Hz	
Tune Voltage	V_{tune}	2	13	V	
Supply Current (I_{cc}) ($V_{cc} = +5.0\text{V}$)		200	240	280	mA
Tune Port Leakage Current ($V_{tune} = 13\text{V}$)			10	μA	
Output Return Loss		2		dB	
Harmonics/Subharmonics	1/2 2nd 3rd	40 20 35		dBc dBc dBc	
Pulling (into a 2.0:1 VSWR)		8		MHz/pp	
Pushing @ $V_{tune} = 5\text{V}$		10		MHz/V	
Frequency Drift Rate		1.0		MHz/ $^\circ\text{C}$	

For price, delivery, and to place orders, please contact Hittite Microwave Corporation:

SUNSTAR 射频微波光电 <http://www.rfmoe.net/> TEL:0755-83396822 FAX:0755-83376182 E-MAIL: szss20@163.com

Order On-line at www.hittite.com



HMC508LP5 / 508LP5E

MMIC VCO w/ HALF FREQUENCY OUTPUT 7.3 - 8.2 GHz

Frequency vs. Tuning Voltage, T= 25°C

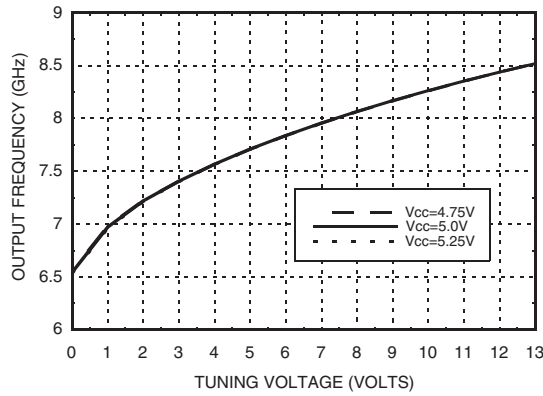

Frequency vs. Tuning Voltage, Vcc= +5V

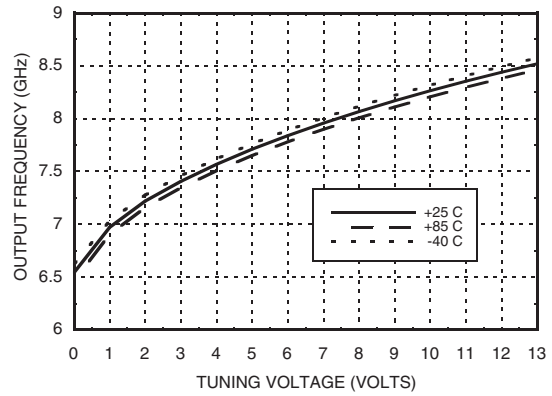

Sensitivity vs. Tuning Voltage, Vcc= +5V

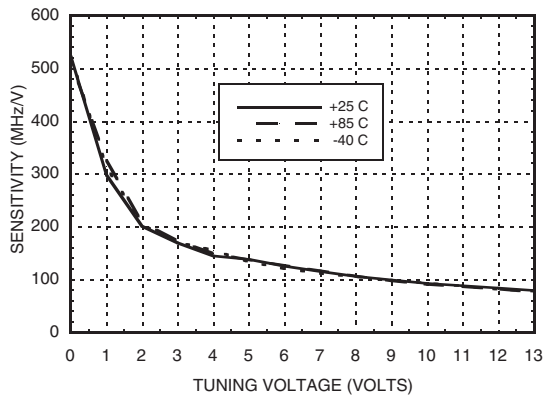

Output Power vs. Tuning Voltage, Vcc= +5V

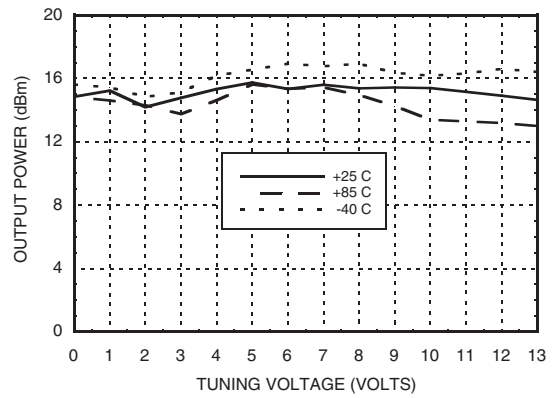

SSB Phase Noise vs. Tuning Voltage

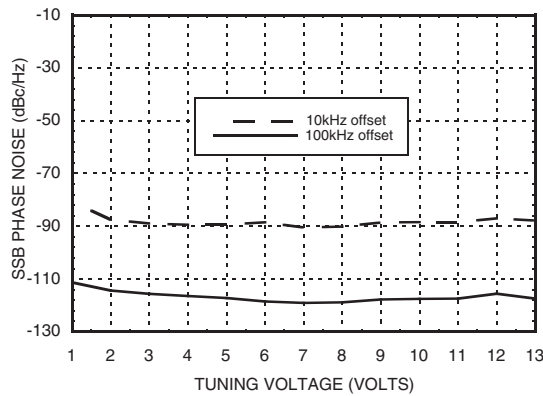

SSB Phase Noise @ Vtune = +5V

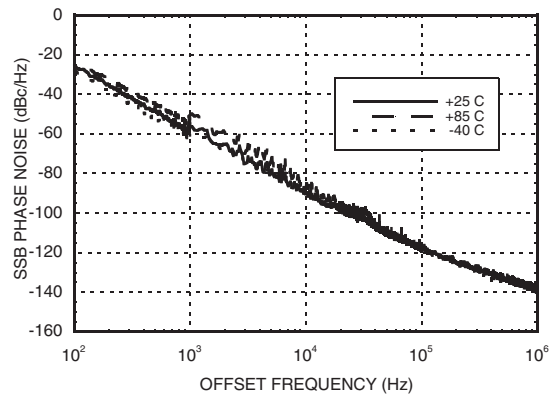



HMC508LP5 / 508LP5E

MMIC VCO w/ HALF FREQUENCY OUTPUT 7.3 - 8.2 GHz

**RFOUT/2 Frequency
vs. Tuning Voltage, Vcc= +5V**

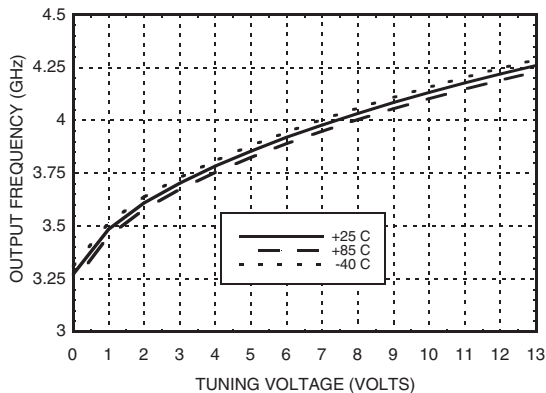

**RFOUT/2 Output Power
vs. Tuning Voltage, Vcc= +5V**

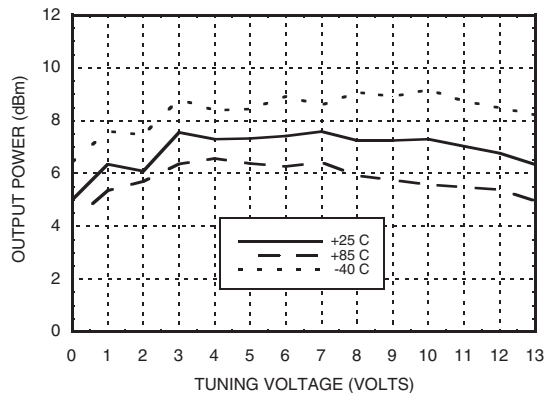

Absolute Maximum Ratings

Vcc	+5.5 Vdc
Vtune	0 to +15V
Junction Temperature	135 °C
Continuous Pdiss (T=85 °C) (derate 28 mW/C above 85 °C)	1.4 W
Thermal Resistance (junction to ground paddle)	35 °C/W
Storage Temperature	-65 to +150 °C
Operating Temperature	-40 to +85 °C
ESD Sensitivity (HBM)	Class 1A

Typical Supply Current vs. Vcc

Vcc (V)	Icc (mA)
4.75	220
5.0	240
5.25	260

Note: VCO will operate over full voltage range shown above.



**ELECTROSTATIC SENSITIVE DEVICE
OBSERVE HANDLING PRECAUTIONS**



MMIC VCO w/ HALF FREQUENCY OUTPUT 7.3 - 8.2 GHz

Outline Drawing

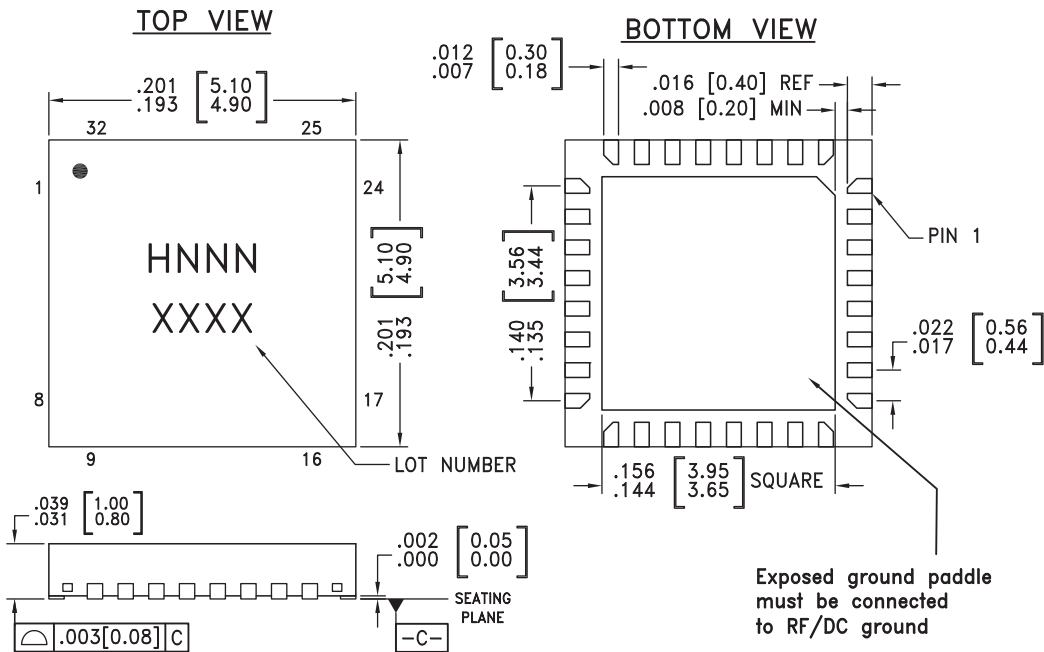

- NOTES:
1. LEADFRAME MATERIAL: COPPER ALLOY
 2. DIMENSIONS ARE IN INCHES [MILLIMETERS]
 3. LEAD SPACING TOLERANCE IS NON-CUMULATIVE.
 4. PAD BURR LENGTH SHALL BE 0.15mm MAXIMUM.
PAD BURR HEIGHT SHALL BE 0.05mm MAXIMUM.
 5. PACKAGE WARP SHALL NOT EXCEED 0.05mm.
 6. ALL GROUND LEADS AND GROUND PADDLE MUST BE SOLDERED TO PCB RF GROUND.
 7. REFER TO HITTITE APPLICATION NOTE FOR SUGGESTED LAND PATTERN.

Package Information



Part Number	Package Body Material	Lead Finish	MSL Rating	Package Marking ^[3]
HMC508LP5	Low Stress Injection Molding Plastic	Sn/Pb Solder	MSL3 ^[1]	H508 XXXX
HMC508LP5E	RoHS-compliant Low Stress Injection Molding Plastic	100% matte Sn	MSL3 ^[2]	H508 XXXX

[1] Max peak reflow temperature of 235 °C
 [2] Max peak reflow temperature of 260 °C
 [3] 4-Digit lot number XXXX

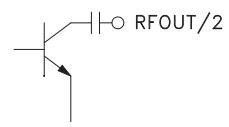
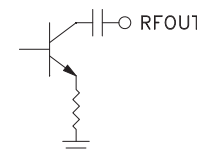
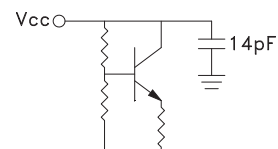
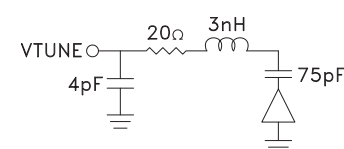

MMIC VCO w/ HALF FREQUENCY OUTPUT 7.3 - 8.2 GHz

Pin Descriptions

Pin Number	Function	Description	Interface Schematic
1 - 4, 6 - 10, 13 - 18, 20, 22 - 28, 30 - 32	N/C	No Connection. These pins may be connected to RF/ DC ground. Performance will not be affected.	
12	RFOUT/2	Half frequency output (AC coupled).	
19	RFOUT	RF output (AC coupled).	
21	Vcc	Supply Voltage, +5V	
29	VTUNE	Control Voltage Input. Modulation port bandwidth dependent on drive source impedance.	
5, 11, Paddle	GND	Package bottom has an exposed metal paddle that must be connected to RF/DC ground.	

12

VCOS WITH Fo/2 OUTPUT - SMT

Evaluation PCB

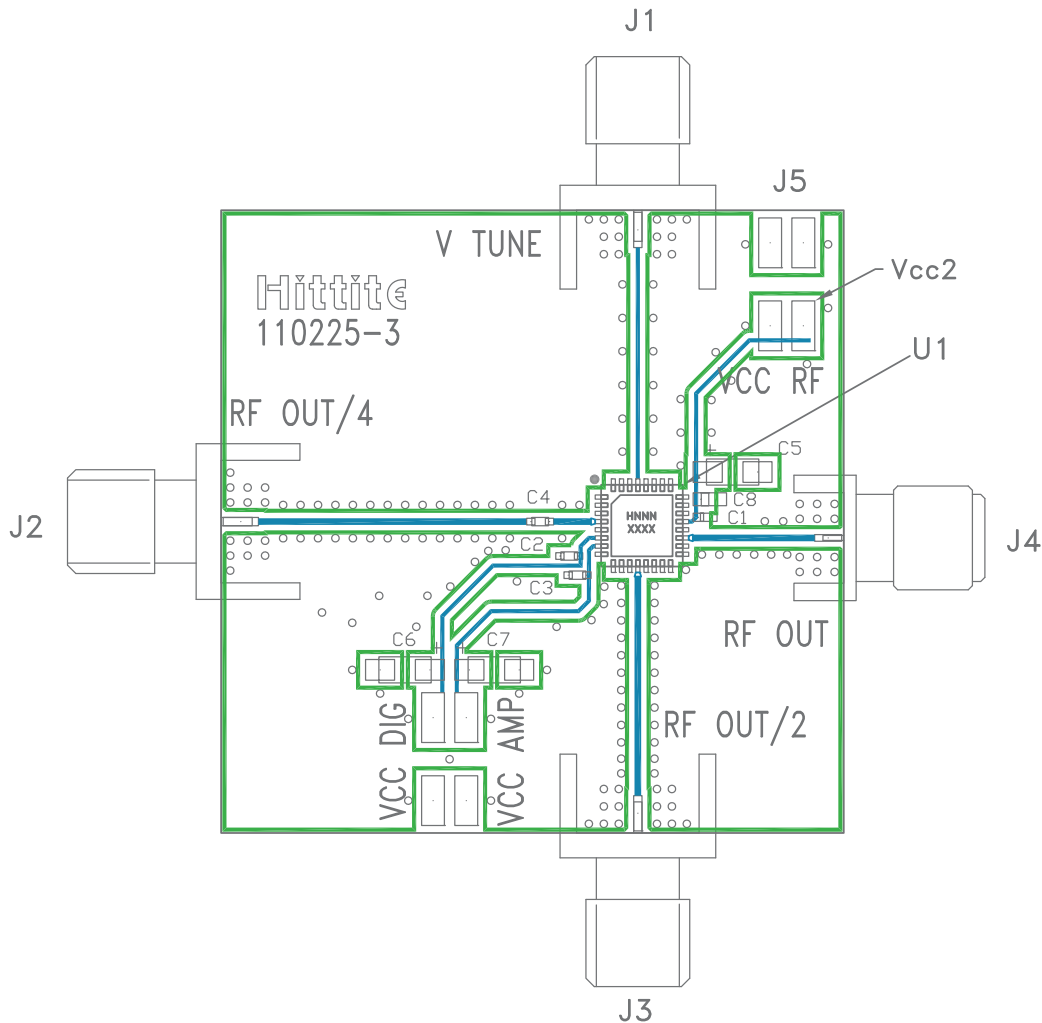

List of Materials for Evaluation PCB 110227 [1]

Item	Description
J1 - J4	PCB Mount SMA RF Connector
J5	2 mm DC Header
C1 - C3	100 pF Capacitor, 0402 Pkg.
C4	1,000 pF Capacitor, 0402 Pkg.
C5 - C7	2.2 μ F Tantalum Capacitor
U1	HMC508LP5(E) VCO
PCB [2]	110225 Eval Board

[1] Reference this number when ordering complete evaluation PCB

[2] Circuit Board Material: Arlon 25FR

The circuit board used in the final application should use RF circuit design techniques. Signal lines should have 50 ohm impedance while the package ground leads and backside ground paddle should be connected directly to the ground plane similar to that shown. A sufficient number of via holes should be used to connect the top and bottom ground planes. The evaluation circuit board shown is available from Hittite upon request.