

**GaAs HBT MMIC  
 DIVIDE-BY-8, DC - 12 GHz**

**Typical Applications**

Prescaler for DC to X Band PLL Applications:

- Satellite Communication Systems
- Fiber Optic
- Point-to-Point and Point-to-Multi-Point Radios
- VSAT

**Features**

- Ultra Low SSB Phase Noise: -153 dBc/Hz
- Wide Bandwidth
- Output Power: -6 dBm
- Single DC Supply: +5V
- Small Size: 1.45 x 0.69 x 0.1 mm

**Functional Diagram**

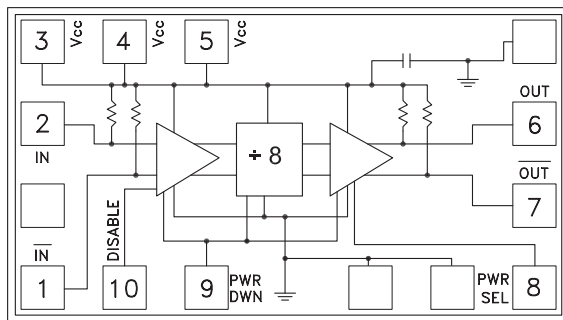

**General Description**

The HMC363 is a low noise Divide-by-8 Static Divider with InGaP GaAs HBT technology that has a small size of 1.45 x 0.69 mm. This device operates from DC (with a square wave input) to 12 GHz input frequency with a single +5V DC supply. The low additive SSB phase noise of -153 dBc/Hz at 100 kHz offset helps the user maintain good system noise performance.

**Electrical Specifications,  $T_A = +25^\circ C$ , 50 Ohm System,  $V_{CC} = 5V$**

Parameter	Conditions	Min.	Typ.	Max.	Units
Maximum Input Frequency		12	13		GHz
Minimum Input Frequency	Sine Wave Input. [1]		0.2	0.5	GHz
Input Power Range	Fin = 1 to 8 GHz	-15	>-20	+10	dBm
	Fin = 8 to 10 GHz	-10	>-15	+2	dBm
	Fin = 10 to 12 GHz	-5	>-8	0	dBm
Output Power [2]	Fin = 12 GHz	-9	-6		dBm
Reverse Leakage	Both RF Outputs Terminated		60		dB
SSB Phase Noise (100 kHz offset)	Pin = 0 dBm, Fin = 6 GHz		-153		dBc/Hz
Output Transition Time	Pin = 0 dBm, Fout = 882 MHz		100		ps
Supply Current (Icc) [2]			70		mA

[1] Divider will operate down to DC for square-wave input signal.

[2] When operated in low power mode (pin 8 floating).

**GaAs HBT MMIC  
 DIVIDE-BY-8, DC - 12 GHz**

**Input Sensitivity Window,  $T = 25^\circ\text{C}$**

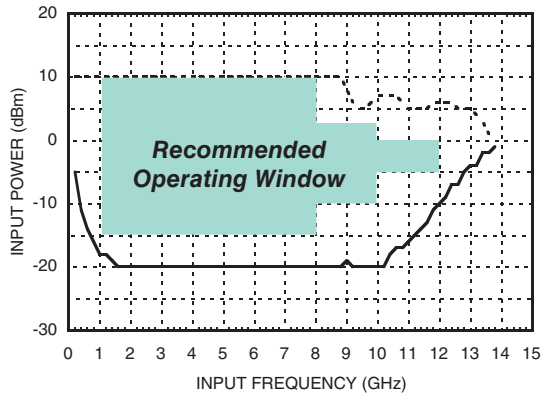

**Input Sensitivity Window vs. Temperature**

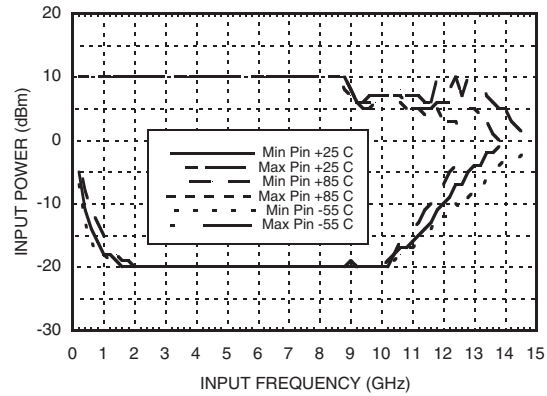

**Output Power vs. Temperature**

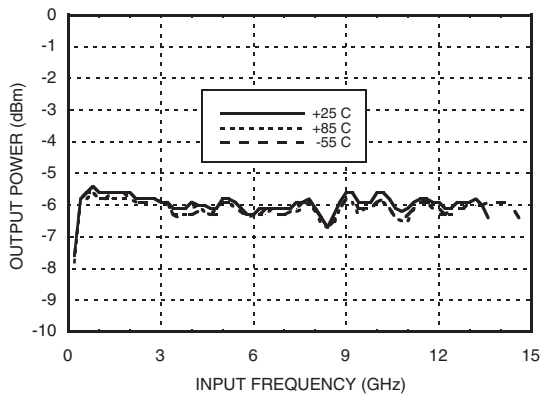

**SSB Phase Noise Performance,  $P_{in} = 0\text{ dBm}$ ,  $T = 25^\circ\text{C}$**

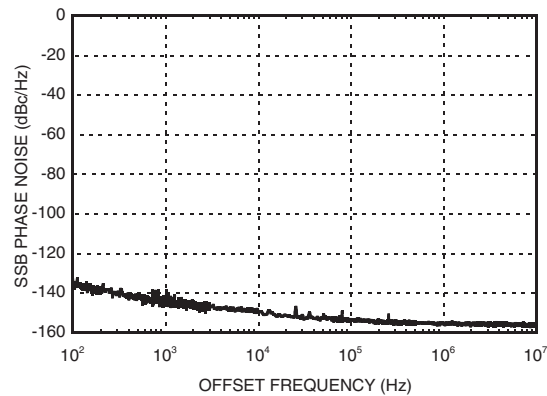

**Output Harmonic Content,  $P_{in} = 0\text{ dBm}$ ,  $T = 25^\circ\text{C}$**

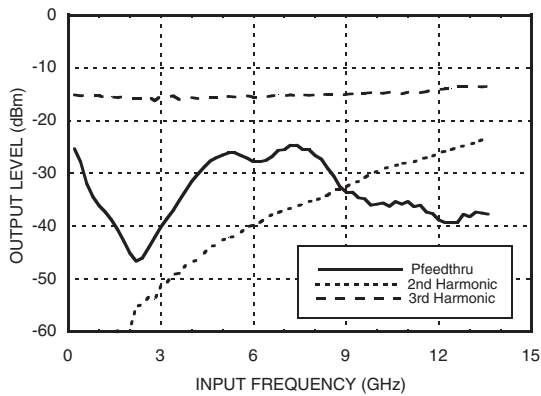

**Reverse Leakage,  $P_{in} = 0\text{ dBm}$ ,  $T = 25^\circ\text{C}$**

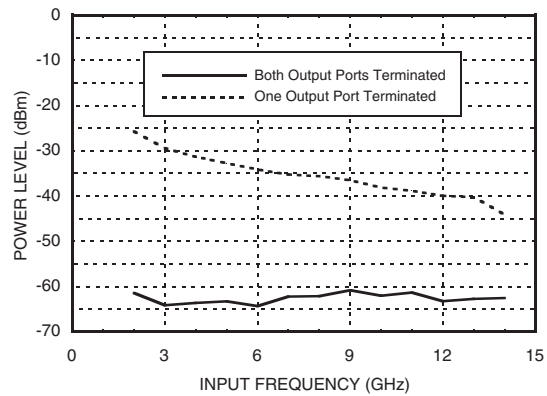

**GaAs HBT MMIC  
DIVIDE-BY-8, DC - 12 GHz**

1

FREQUENCY DIVIDERS - CHIP

**Output Voltage Waveform,  
Pin= 0 dBm, Fout= 882 MHz, T= 25 °C**

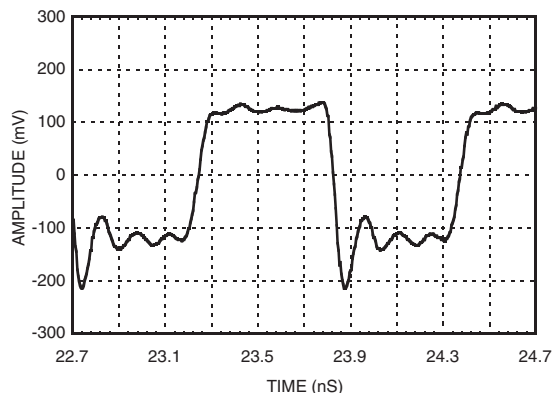

**Absolute Maximum Ratings**

RF Input (Vcc = +5V)	+13 dBm
Vcc	+5.5V
VLogic	Vcc -1.6V to Vcc -1.2V
Storage Temperature	-65 to +150 °C
Operating Temperature	-55 to +85 °C



**ELECTROSTATIC SENSITIVE DEVICE  
OBSERVE HANDLING PRECAUTIONS**

**Typical Supply Current vs. Vcc**

Vcc (V)	Icc (mA)
4.75	64
5.0	70
5.25	75

Note: Divider will operate over full voltage range shown above

**Outline Drawing**

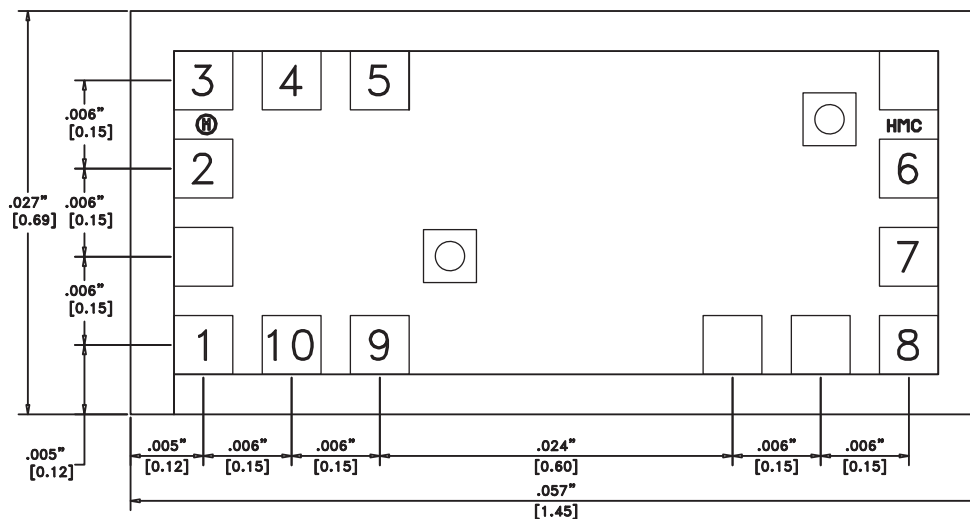

**Die Packaging Information [1]**

Standard	Alternate
WP-8 (Waffle Pack)	[2]

[1] Refer to the "Packaging Information" section for die packaging dimensions.

[2] For alternate packaging information contact Hittite Microwave Corporation.

**NOTE:**

- ALL DIMENSIONS IN INCHES (MILLIMETERS)
- ALL TOLERANCES ARE ±0.001 (0.025)
- DIE THICKNESS IS 0.004 (0.100) BACKSIDE IS GROUND
- BOND PADS ARE 0.004 (0.100) SQUARE
- BOND PAD SPACING, CTR-CTR: 0.006 (0.150)
- BACKSIDE METALLIZATION: GOLD
- BOND PAD METALLIZATION: GOLD

For price, delivery, and to place orders, please contact Hittite Microwave Corporation:

SUNSTAR 微波光电 <http://www.hittite.com> / TEL:0755-83396822 FAX:0755-83376182 E-MAIL: szss20@163.com

Order On-line at [www.hittite.com](http://www.hittite.com)

**GaAs HBT MMIC  
DIVIDE-BY-8, DC - 12 GHz**

**Pad Description**

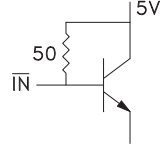
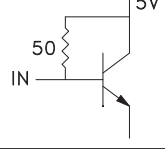
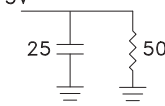
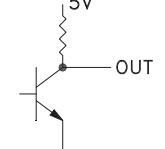
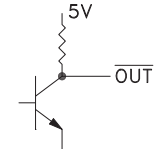
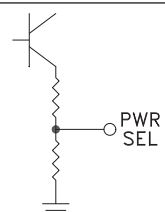
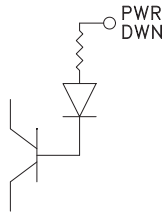
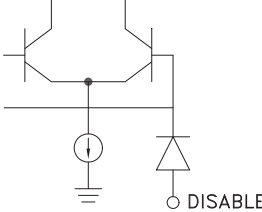
Pad Number	Function	Description	Interface Schematic
1	$\overline{IN}$	RF Input 180° out of phase with pad 3 for differential operation. AC ground for single ended operation.	
2	IN	RF Input must be DC blocked.	
3, 4, 5	Vcc	Supply Voltage 5V ±0.25V can be applied to pad 3, 4, or 5.	
6	OUT	Divided Output	
7	$\overline{OUT}$	Divided output 180° out of phase with OUT.	
8	PWR SEL	In the low power mode, the power select pin is left floating. By grounding this pin, the output power is increased by approximately 10 dB.	
9	PWR DWN	The power down pin is grounded for normal operation. Applying 5 volts to this pin will power down this device.	
10	DISABLE	The disable pin is grounded for normal operation. Applying 5 volts to this pin will disable the input buffer amplifier.	

**GaAs HBT MMIC  
DIVIDE-BY-8, DC - 12 GHz**

**Truth Table**

Function	Pin	5V	GND	Float
DISABLE	10	Output Off	Output On	X
PWR DWN	9	Power Down	Power Up	X
PWR SEL	8	X	High Power Output	Low Power Output

X = State not permitted.

**Assembly Diagram**

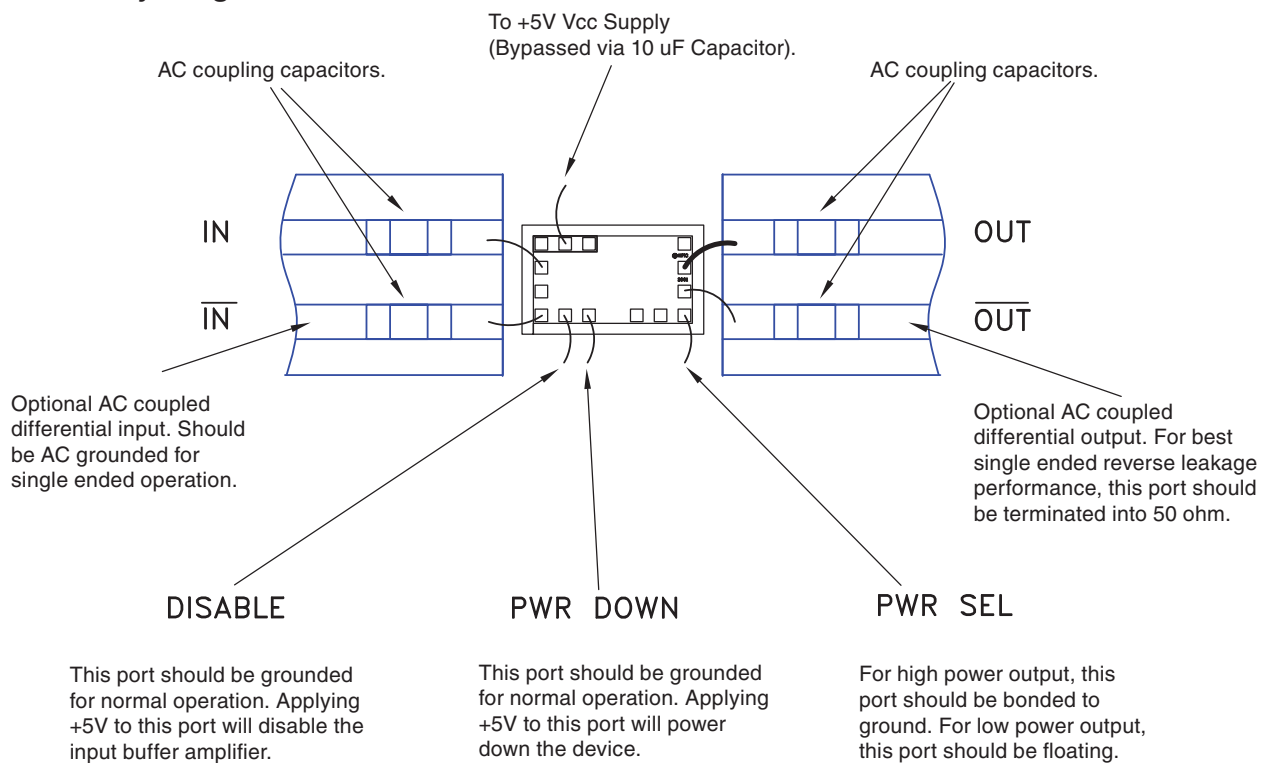

**GaAs HBT MMIC  
DIVIDE-BY-8, DC - 12 GHz**

### **Handling Precautions**

*Follow these precautions to avoid permanent damage.*

**Cleanliness:** Handle the chips in a clean environment. DO NOT attempt to clean the chip using liquid cleaning systems.

**Static Sensitivity:** Follow ESD precautions to protect against ESD strikes.

**Transients:** Suppress instrument and bias supply transients while bias is applied. Use shielded signal and bias cables to minimize inductive pick-up.

**General Handling:** Handle the chip along the edges with a vacuum collet or with a sharp pair of bent tweezers. The surface of the chip has fragile air bridges and should not be touched with vacuum collet, tweezers, or fingers.

### **Mounting**

*The chip is back-metallized and can be die mounted with electrically conductive epoxy. The mounting surface should be clean and flat.*

**Epoxy Die Attach:** Apply a minimum amount of epoxy to the mounting surface so that a thin epoxy fillet is observed around the perimeter of the chip once it is placed into position. Cure epoxy per the manufacturer's schedule.

### **Wire Bonding**

Ball or wedge bond with 0.025 mm (1 mil) diameter pure gold wire. Thermosonic wirebonding with a nominal stage temperature of 150 °C and a ball bonding force of 40 to 50 grams or wedge bonding force of 18 to 22 grams is recommended. Use the minimum level of ultrasonic energy to achieve reliable wirebonds. Wirebonds should be started on the chip and terminated on the package or substrate. All bonds should be as short as possible <0.31 mm (12 mils).