



Typical Applications

The HMC705LP4(E) is ideal for:

- Satellite Communication Systems
- Point-to-Point Radios
- Military Applications
- Sonet Clock Generation
- Test Equipment

Features

- Ultra Low SSB Phase Noise Floor:
 -153 dBc/Hz @ 100 kHz
- Programmable Divider (N= 1 - 17) Operating
 up to 6.5 GHz
- 24 Lead 4X4mm SMT Package: 16mm²

Functional Diagram

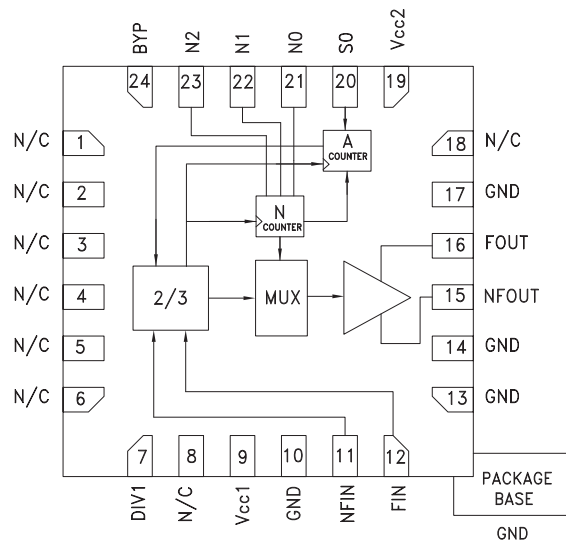

General Description

The HMC705LP4(E) is a low noise GaAs HBT programmable divider in a 4x4 mm leadless surface mount package. The divider can be programmed to divide by any number from N = 1 to N = 17 up to 6.5 GHz. The HMC705LP4E's high frequency operation along with low phase noise floor is very useful in high performance fast settling synthesizer architectures. The HMC705LP4E may be combined with Hittite's Phase Frequency Detectors, VCOs and PLL ICs to create low noise, fast settling phase locked loops.

Electrical Specifications, $T_A = +25^\circ C$, $V_{cc} = V_{cc1} = V_{cc2} = +5V$

Parameter	Conditions	Min.	Typ.	Max.	Units
Maximum Input Frequency	Sine Wave or Square Wave Input	6.5			GHz
Minimum Input Frequency	Sine Wave or Square Wave Input			0.1	GHz
Input Power Range	$F_{in} = 0.1$ to 6.5 GHz*	-15	0	10	dBm
Output Power	Divide-by-2		0		dBm
SSB Phase Noise	$F_{in} = 6$ GHz, $N = 17$		-153		dBc/Hz
Total Supply Current			190		mA

* For sine wave inputs less than 400 MHz input power must be greater than or equal to -5 dBm

**6.5 GHz PROGRAMMABLE
 DIVIDER (N = 1 - 17)**



Input Sensitivity Window, All States

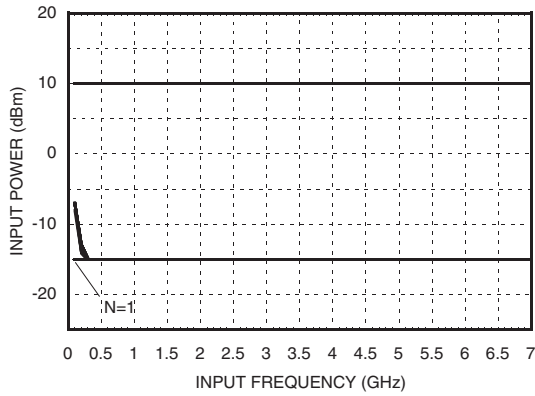

Input Sensitivity Window vs. Temperature, N = 17, T = -40°C to +85°C

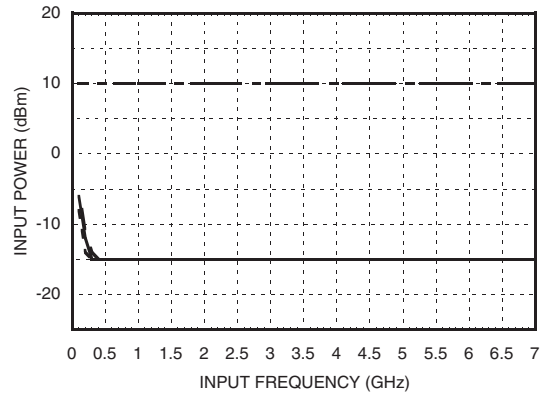

Output Power, Divide Ratio States 1 through 5

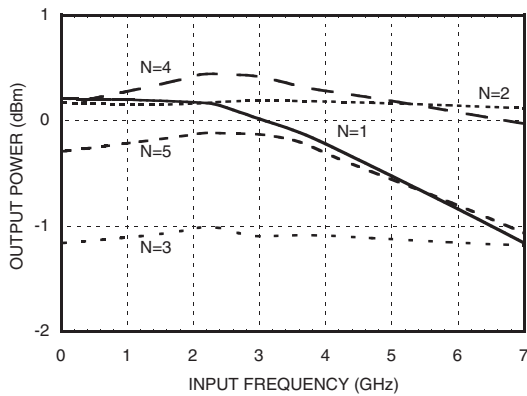

Output Power, Divide Ratio States 6 through 17

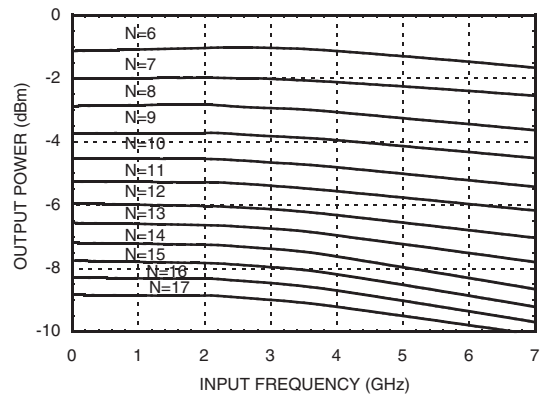

Fundamental Feedthru Power, Pin = 0 dBm

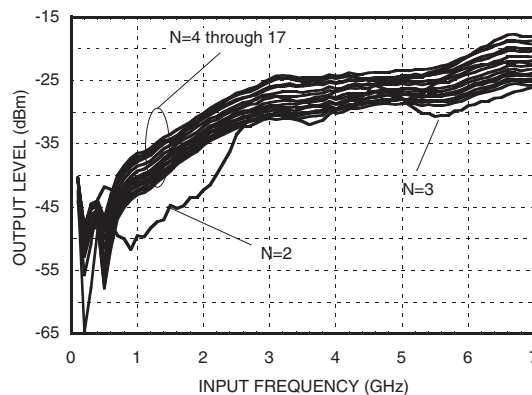

**6.5 GHz PROGRAMMABLE
 DIVIDER (N = 1 - 17)**



6

FREQUENCY DIVIDERS & DETECTORS - SMT

SSB Phase Noise Performance

$F_{in} = 6 \text{ GHz}, N = 2; T = -40^\circ\text{C}, +25^\circ\text{C}, +85^\circ\text{C}$

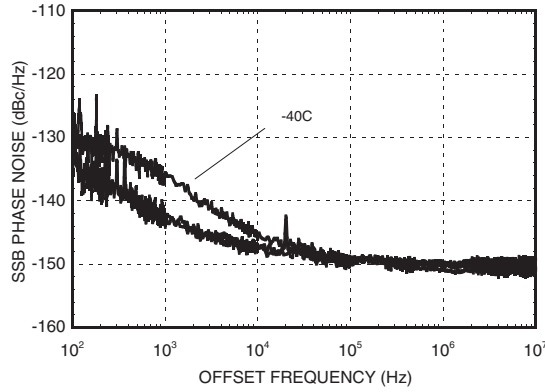

SSB Phase Noise Performance

$F_{in} = 6 \text{ GHz}, N = 17; T = -40^\circ\text{C}, +25^\circ\text{C}, +85^\circ\text{C}$

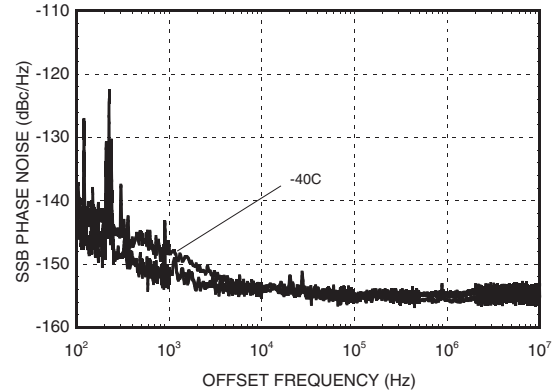

SSB Phase Noise Performance

$F_{in} = 6 \text{ GHz}, N = 2; V_{cc} = 4.75\text{V}, 5\text{V}, 5.25\text{V}$

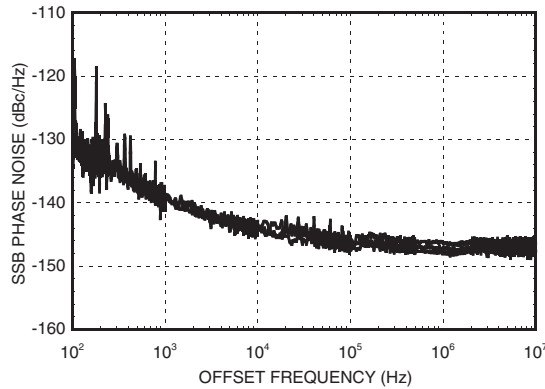

SSB Phase Noise Performance

$F_{in} = 6 \text{ GHz}, N = 17; V_{cc} = 4.75\text{V}, 5\text{V}, 5.25\text{V}$

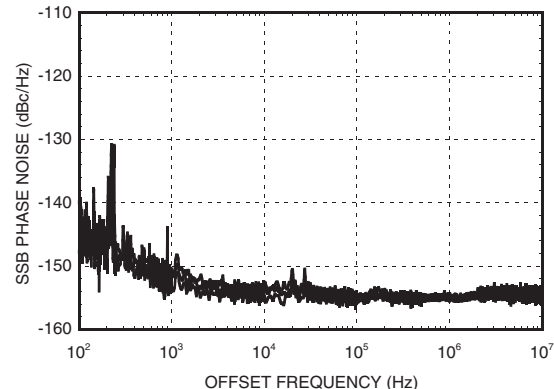

2nd Harmonic, N = 1 through 5

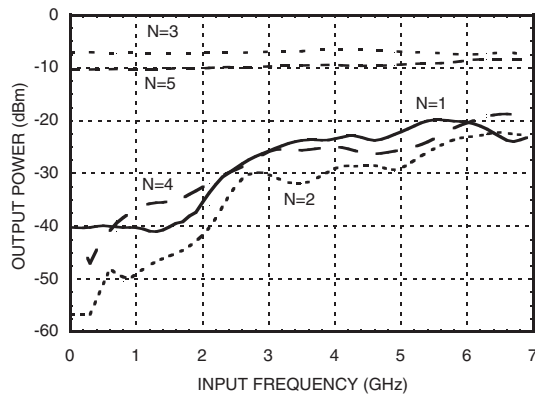

2nd Harmonic, N = 6 through 17

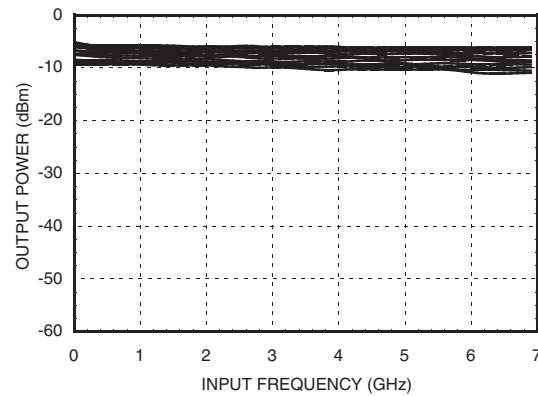

**6.5 GHz PROGRAMMABLE
 DIVIDER (N = 1 - 17)**



3rd Harmonic, N = 1 through 5

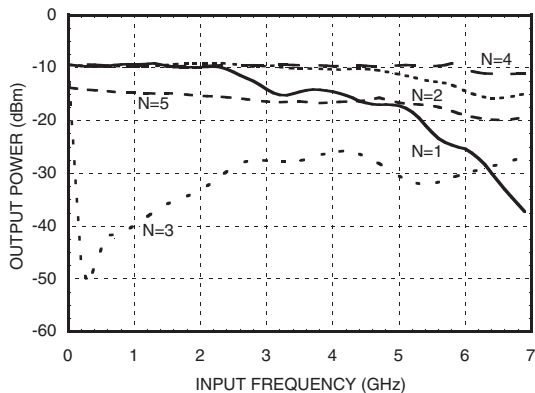

3rd Harmonic, N = 6 through 17

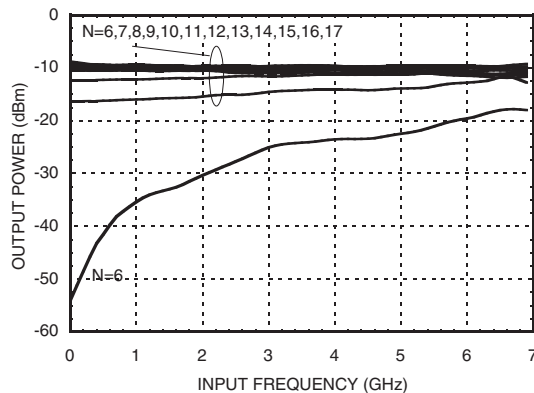

4th Harmonic, N = 1 through 5

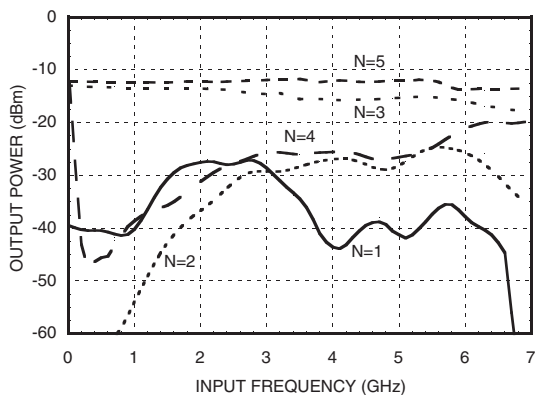

4th Harmonic, N = 6 through 17

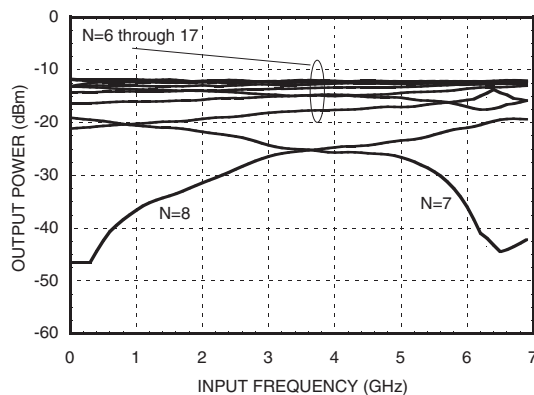

5th Harmonic, N = 1 through 5

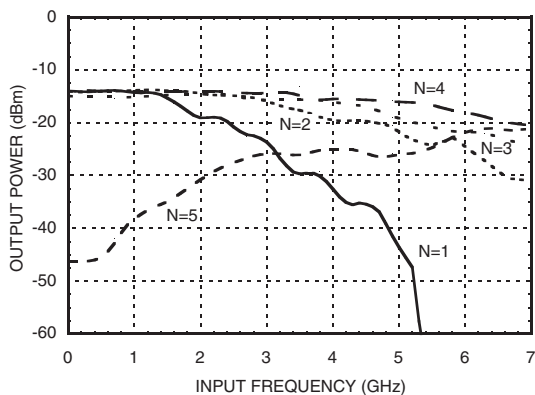

5th Harmonic, N = 6 through 17

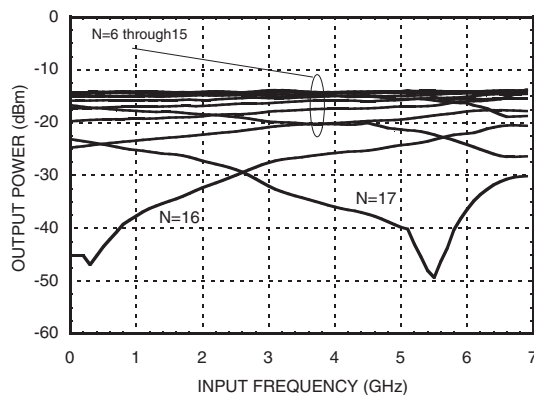

HMC705LP4 / 705LP4E

6.5 GHz PROGRAMMABLE DIVIDER (N = 1 - 17)



Output Voltage Waveform, $F_{in} = 500$ MHz, $N = 2$, $P_{in} = 0$ dBm, $T = 25$ °C

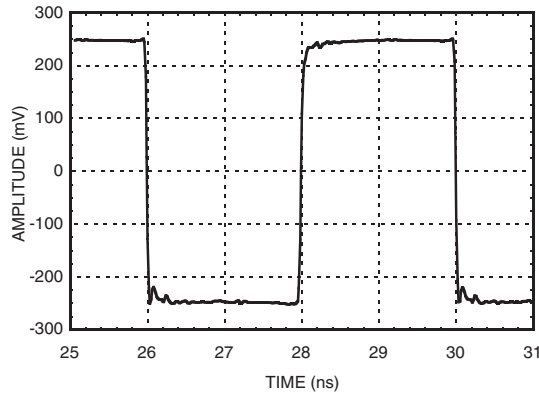

Output Voltage Waveform, $F_{in} = 750$ MHz, $N = 3$, $P_{in} = 0$ dBm, $T = 25$ °C

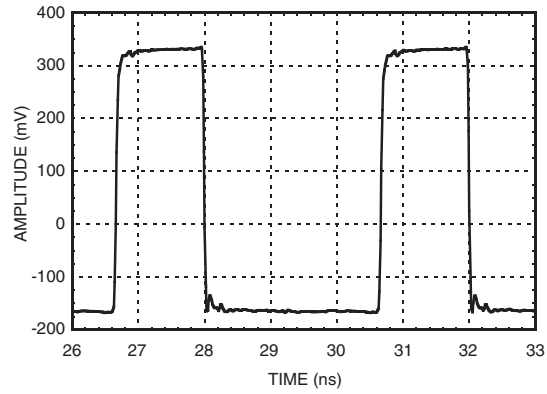

Output Voltage Waveform, $F_{in} = 2500$ MHz, $N = 10$, $P_{in} = 0$ dBm, $T = 25$ °C

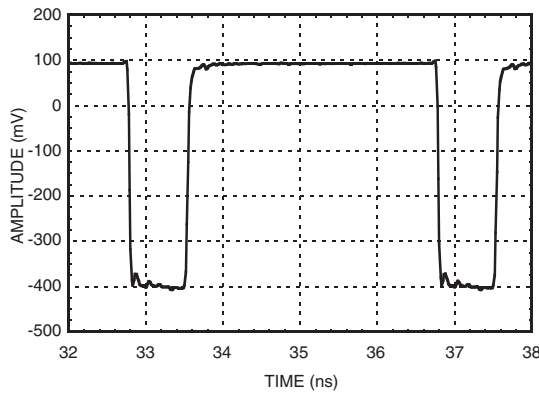

Output Voltage Waveform, $F_{in} = 4250$ MHz, $N = 17$, $P_{in} = 0$ dBm, $T = 25$ °C

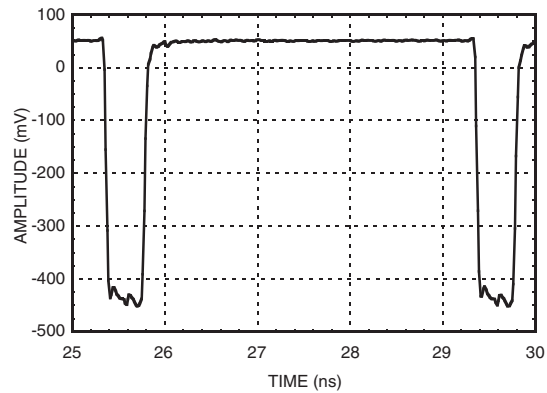

N	Output Duty Cycle (%)
1	Input
2	50
3 - 17	$[1 - (2/N)] \times 100$

Note:

- [1] Peak to peak amplitude does not change relative to N.
- [2] Pulse duty cycle changes relative to N.



6.5 GHz PROGRAMMABLE DIVIDER (N = 1 - 17)

Absolute Maximum Ratings

RF Input (Vcc= +5V)	+13 dBm
Supply Voltage (Vcc)	+5.5V
Logic Inputs	-0.5V to (0.5V + Vcc)
Junction Temperature (Tc)	135 °C
Continuous Pdiss (T = 85 °C) (derate 49 mW/° C above 85 °C)	2.4 W
Thermal Resistance (Junction to ground paddle)	20.5 °C/W
Storage Temperature	-65 to +150 °C
Operating Temperature	-40 to +85 °C

Typical Supply Current vs. Vcc

Vcc (V)	Icc (mA)
4.75	180
5.00	190
5.25	210

Note: HMC705LP4E will work over full voltage range above.



ELECTROSTATIC SENSITIVE DEVICE
OBSERVE HANDLING PRECAUTIONS

Outline Drawing

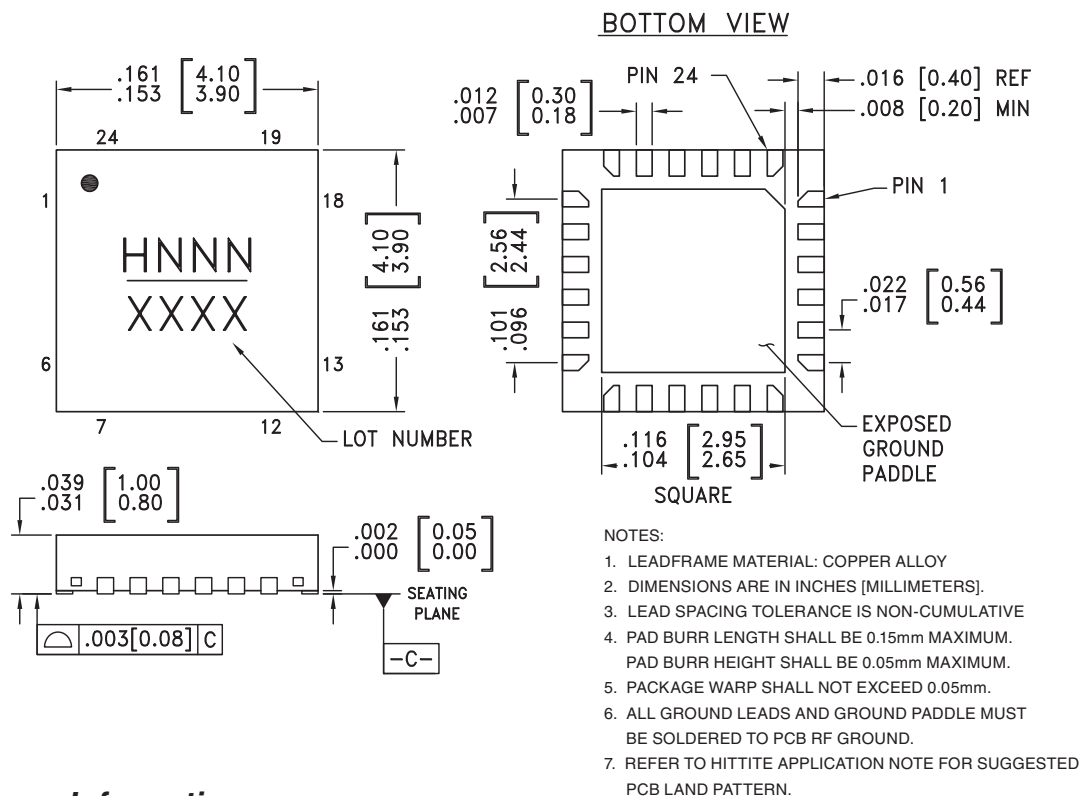

Package Information

Part Number	Package Body Material	Lead Finish	MSL Rating	Package Marking ^[3]
HMC705LP4	Low Stress Injection Molded Plastic	Sn/Pb Solder	MSL1 ^[1]	H705 XXXX
HMC705LP4(E)	RoHS-compliant Low Stress Injection Molded Plastic	100% matte Sn	MSL1 ^[2]	H705 XXXX

[1] Max peak reflow temperature of 235 °C
 [2] Max peak reflow temperature of 260 °C
 [3] 4-Digit lot number XXXX



6.5 GHz PROGRAMMABLE DIVIDER (N = 1 - 17)

6

FREQUENCY DIVIDERS & DETECTORS - SMT

Pin Description

Pin Number	Function	Description	Interface Schematic
1 - 6, 8, 18	N/C	The pins are not connected internally; however, all data shown herein was measured with these pins connected to RF/DC ground externally.	
7, 20 - 24	DIV1, S0 N0 - N2 BYP	<p>PFD INVERT function</p> <p>CMOS compatible input control bit</p> <p>Logic "LOW" = NORMAL</p> <p>Logic "HIGH" = INVERT</p>	
9, 19	Vcc1, Vcc2	Supply Voltage	
10, 13, 14, 17	GND	These pins and package bottom must be connected to RF DC ground.	
11	NFIN	(These pins are AC coupled and must be DC Blocked externally.) Frequency Input	
12	FIN	Frequency Input Complement	
15	NFout	Frequency, output complement	
16	Fout	Frequency output	



MICROWAVE CORPORATION v03.0709



HMC705LP4 / 705LP4E

6.5 GHz PROGRAMMABLE DIVIDER (N = 1 - 17)

6

HMC705LP4(E) Programming Truth Table

Division Ratio N	S0	N0	N1	N2	DIV 1	BYP
1	0	0	0	0	0	1
2	0	0	0	0	1	0
3	1	0	0	0	1	0
4	0	1	0	0	0	0
5	1	1	0	0	0	0
6	0	0	1	0	0	0
7	1	0	1	0	0	0
8	0	1	1	0	0	0
9	1	1	1	0	0	0
10	0	0	0	1	0	0
11	1	0	0	1	0	0
12	0	1	0	1	0	0
13	1	1	0	1	0	0
14	0	0	1	1	0	0
15	1	0	1	1	0	0
16	0	1	1	1	0	0
17	1	1	1	1	0	0

0 = Logic Low
1 = Logic High

FREQUENCY DIVIDERS & DETECTORS - SMT



Evaluation PCB Circuit

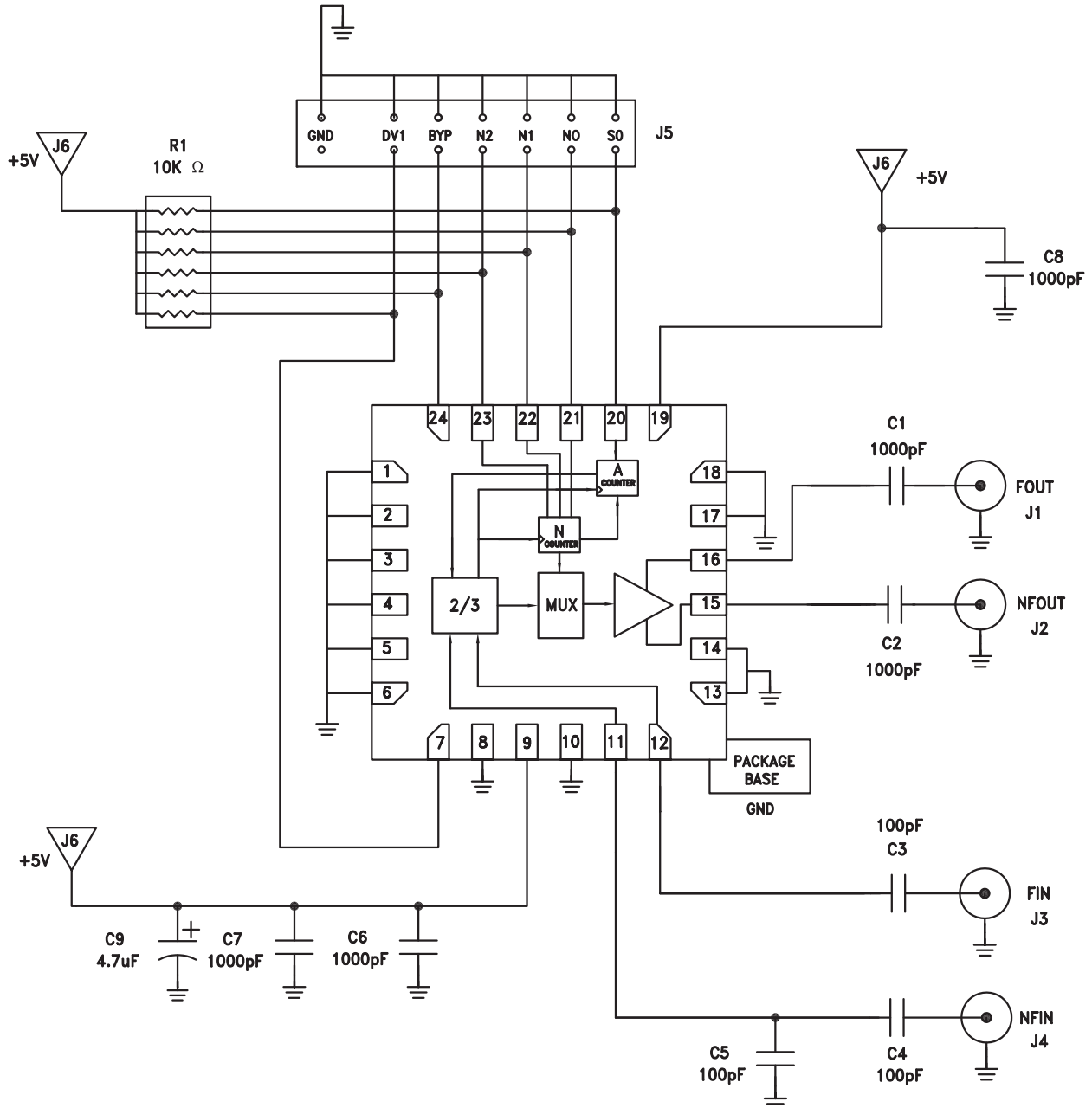

For price, delivery, and to place orders, please contact Hittite Microwave Corporation:

SUNSTAR 射频通信 <http://www.hittite.com> / TEL:0755-83396822 FAX:0755-83376182 E-MAIL: szss20@163.com
Order On-line at www.hittite.com

Evaluation PCB

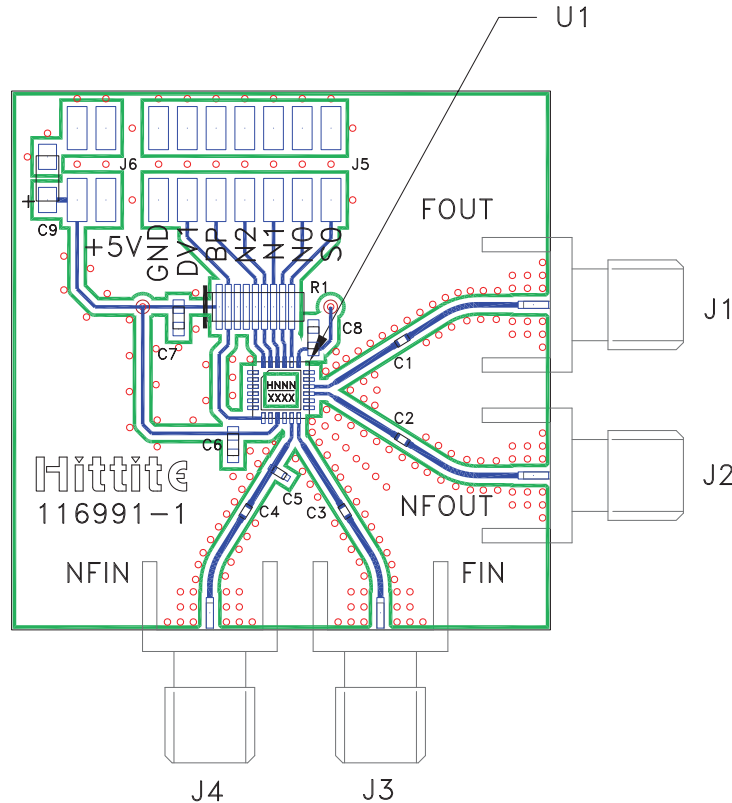

**List of Materials for
 Evaluation PCB 116993 [1]**

Item	Description
J1 - J4	PCB Mount SMA Connector
J5	14 Position Header
J6	4 Position Header
R1	10K Ohm Resistor Network, Bissel SMD
C1, C2	1000 pF Capacitor, 0402 Pkg.
C3 - C5	100 pF Capacitor, 0402 Pkg.
C6 - C8	1000 pF Capacitor, 0603 Pkg.
C9	4.7 μ F Tantalum Capacitor, Case A
U1	HMC705LP4(E) Programmable Divider
PCB [2]	116991 Eval Board

[1] Reference this number when ordering complete evaluation PCB

[2] Circuit Board Material: Rogers 4350

The circuit board used in the final application should use RF circuit design techniques. Signal lines should have 50 ohm impedance while the package ground leads and backside ground paddle should be connected directly to the ground plane similar to that shown. A sufficient number of via holes should be used to connect the top and bottom ground planes. The evaluation circuit board shown is available from Hittite upon request.

HMC705LP4 / 705LP4E

6.5 GHz PROGRAMMABLE DIVIDER (N = 1 - 17)

Typical PLL Application Circuit using HMC705LP4

PLL application shown for Divide-by-10. Contact HMC to discuss your specific application.

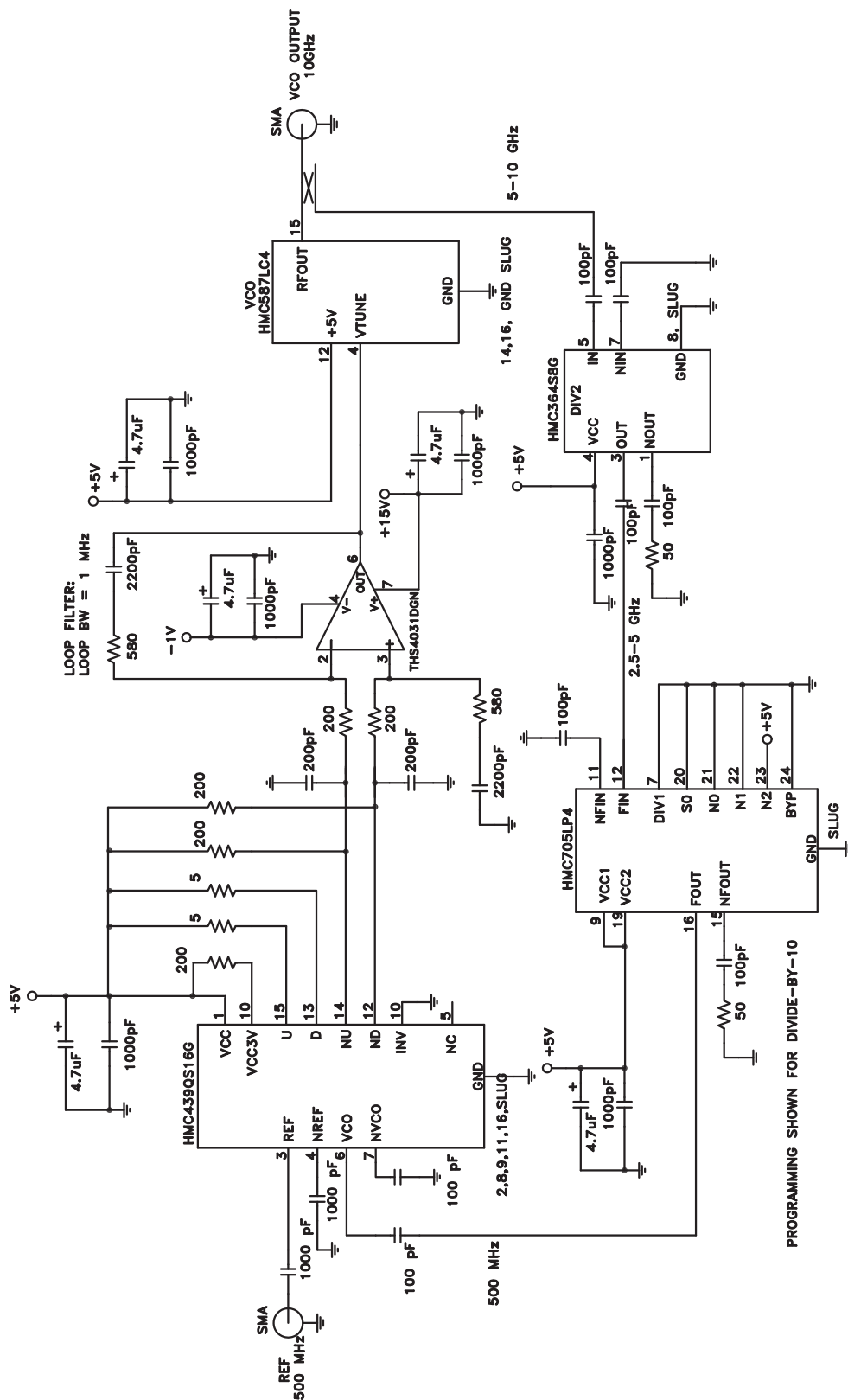

For price, delivery, and to place orders, please contact Hittite Microwave Corporation:

SUNSTAR 微波光电 http://www.hittite.com/ TEL:0755-83396822 FAX:0755-83376182 E-MAIL: szss20@163.com
Order On-line at www.hittite.com



6.5 GHz PROGRAMMABLE DIVIDER (N = 1 - 17)

Typical Application Showing Spurious Performance

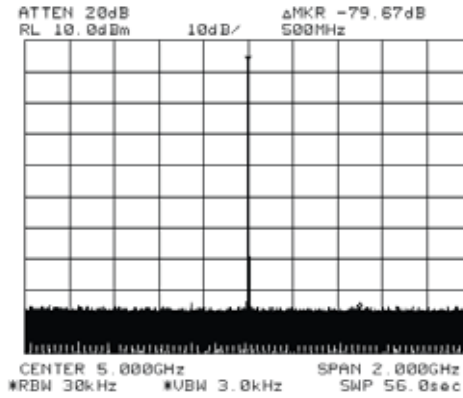

CMOS/TTL Input Characteristics

Maximum Input Logic "0" Voltage ($V_{IL\ MAXIMUM}$) = 1.1V @ 1 μ A.

Minimum Input Logic "1" Voltage ($V_{IH\ MINIMUM}$) = 1.8V @ 50 μ A.

Input IV characteristics for the logic inputs (S0, N0 - N2, DIV1, BYP) are shown below:

