



CRYSTAL OSCILLATORS

10KH PECL 5V

FULL SIZE D.I.L. M package HALF SIZE D.I.L. H package

M1700, M1736,
M1744, M1745,
M1748, M1900,
M1936, M1944,
M1945, M1948,
M2700, M2736,
M2744, M2745,
M2748

H1700, H1736,
H1744, H1745,
H1748, H1900,
H1936, H1944,
H1945, H1948,
H2700, H2736,
H2744, H2745,
H2748

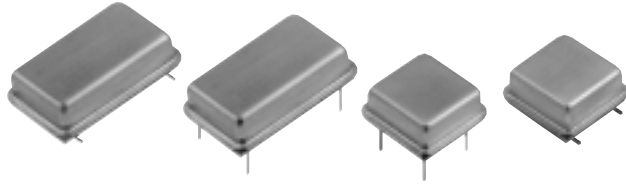

Thru-Hole / Gull Wing

Commercial: 0° to 70°C
10 MHZ to 210 MHZ

The MF PECL oscillators are available in a variety of common configurations. Models are full size or half size, in 10 KH logic, with and without complementary outputs. Frequency tolerances from 100 ppm to 20 ppm include all effects of voltage, load and aging.

FEATURES

- DIL – full size or half size
- Single or dual complementary outputs
- H1900 and M1900 have Enable/Disable, reducing noise of unwanted frequency
- Start up time less than 5 ms
- Stability options from .01% (100 ppm) to .002% (20 ppm)
- Guaranteed start-up with ramping DC Supply
- Terminating resistor may be internal – consult factory

Description

MF Electronics' high speed clock oscillators for digital and communications applications are based on 5V PECL logic and are available in full size (M) and half size (H) thru-hole packages. Designs in 10KH logic develop 10 MHz to 210 MHz output, and are available with 45/55 symmetry. They can be optionally provided with dual complementary output. Frequency stability extends from the high end at ±20 ppm to ±100 ppm. For superior performance, see our model 2900s using ECLPS logic.

PECL OSCILLATORS

Single Output	Complementary Output	Enable/Disable Output	Frequency Stability
1700	2700	1900	±100 ppm
1736*	2736*	1936*	±100 ppm
1744	2744	1944	±25 ppm
1745	2745	1945	±50 ppm
1748	2748	1948	±20 ppm

* Guaranteed Superior Symmetry 45/55

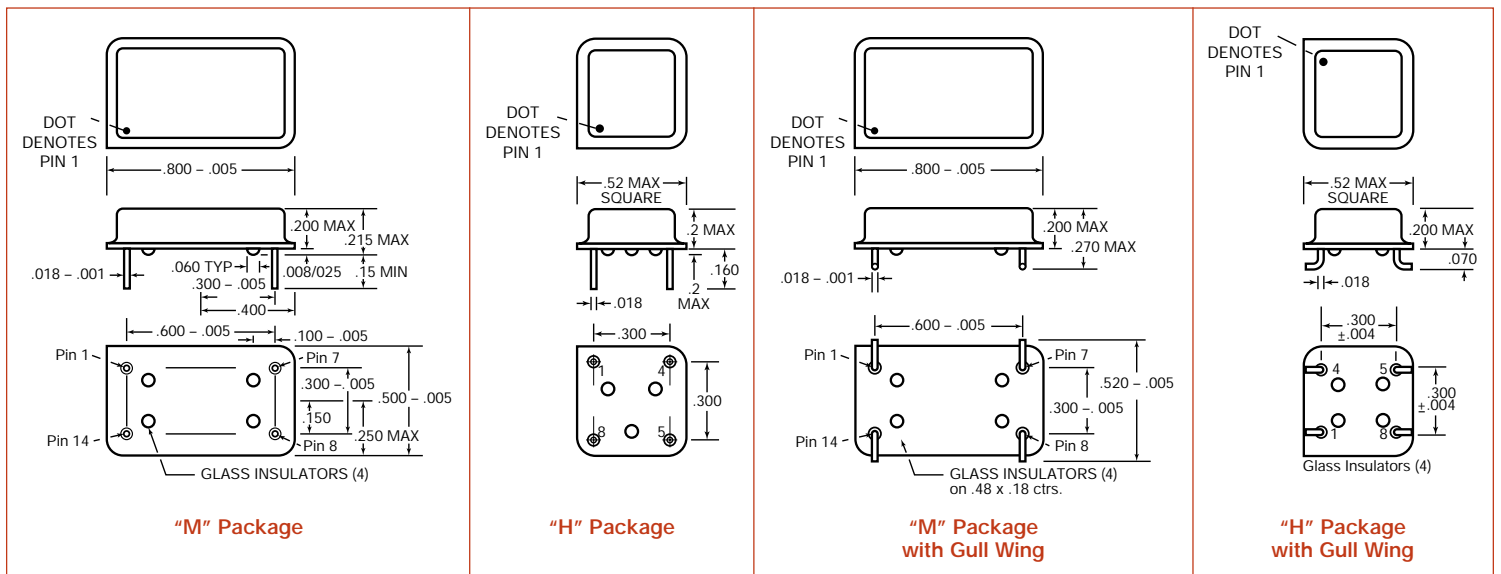



CRYSTAL OSCILLATORS
10KH PECL 5V
Thru-Hole /Gull Wing
Commercial: 0° to 70°
10 MHz to 210 MHz

FULL SIZE D.I.L. M package
M1700, M1736,
M1744, M1745,
M1748, M1900,
M1936, M1944,
M1945, M1948,
M2700, M2736,
M2744, M2745,
M2748

HALF SIZE D.I.L. H package
H1700, H1736,
H1744, H1745,
H1748, H1900,
H1936, H1944,
H1945, H1948,
H2700, H2736,
H2744, H2745,
H2748

TERMINATIONS

All ECL oscillators must be terminated. If required, internal terminating resistors of any specified value may be factory-supplied

ENABLE/DISABLE

The M1900 and H1900 have Enable-Disable feature, which allows several oscillators to be wire-OR'd, so that one frequency of several may be selected. If Pin1. is "0", the output is normal, However, when Pin1. is "1", the oscillator shuts-down, and the output goes to logic "0". The logic "0" may be wire-OR'd.

AUTOMATED TESTING (ATE)

Automated testing can effectively be performed using the M1900, since this model may be turned-off and "0"d, allowing an ECL test frequency to be inserted on the output node.

ELECTRICAL SPECIFICATIONS

Frequency Range 10 MHz to 210 MHz
Frequency Stability Includes calibration at 25°C, operating temperature, change of input voltage, change of load, shock and vibration.

	MIN	TYP	MAX	UNITS
Input Voltage	4.75	5.0	5.25	volts
Input Current		45	60	mA
Output Levels				
"0" Level				
25°C	(V _C -1.95)		(V _C -1.63)	volts
75°	(V _C -1.95)		(V _C -1.60)	volts
"1" Level				
25°C	(V _C -0.98)		(V _C -0.81)	volts
75°	(V _C -0.92)		(V _C -0.735)	volts
Drive Required for 1900 (at ECL levels)			0.85	mA
Rise and Fall Times (20 to 80%)		1.0	2.0	ns
Symmetry				
All units, except '36 Models		45/55	40/60	percent
All '36 Models		48/52	45/55	percent
Aging				
First year		3		ppm
After first year		1		ppm/yr

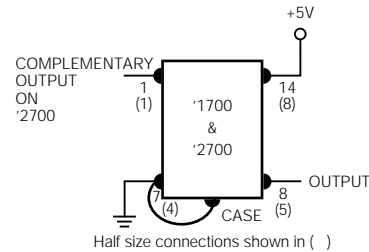

Fig. 1

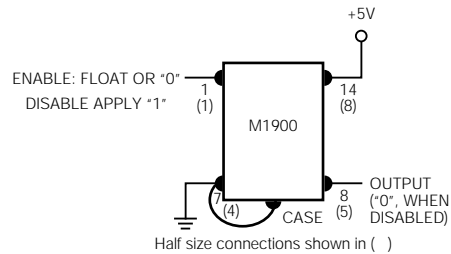

Fig. 2

Note: Outputs must be properly terminated

ENVIRONMENTAL SPECIFICATIONS

Temperature

Operating 0° to 70°C
Storage -55° to +125°C

Shock - 1000 Gs, 0.35 ms, 1/2 sine wave, 3 shocks in each plane

Vibration - 10-2000 Hz of .06" d.a. or 20 Gs, whichever is less

Humidity - Resistant to 85° R.H. at 85°C

MECHANICAL SPECIFICATIONS

Leak - MIL STD 883, Method 1014, condition A1

Pins - Kovar, 7 microinch gold over nickel

Bend Test - Will withstand two bends of 90° from reference

Header - Steel, 7 microinch gold over nickel

Case - Stainless steel, type 304

Marking - Epoxy ink or laser engraved

Resistance to Solvents - MIL STD 202, Method 215





CRYSTAL OSCILLATORS
10KH PECL 5V
Thru-Hole /Gull Wing
Commercial: 0° to 70°
10 MHz to 210 MHz

FULL SIZE D.I.L M package
M1700, M1736, M1744, M1745, M1748, M1900, M1936, M1944, M1945, M1948, M2700, M2736, M2744, M2745, M2748

HALF SIZE D.I.L H package
H1700, H1736, H1744, H1745, H1748, H1900, H1936, H1944, H1945, H1948, H2700, H2736, H2744, H2745, H2748

CONNECTIONS

PINS		H1700, H2700, H1900 M1700, M2700, M1900 Models
Full Size	Half Size	
1.	1.	Not used in Single Output or Used for Complementary Output (Same termination as Pin 8.) Used for H1900 and M1900. Float or "0" for normal operation, "1" for "0" Output
7.	4.	Electrical Ground and Case
8.	5.	Output requires termination of 270 ohms to Pin 7 (4) or 50 ohms to +3V
14.	8.	+5V, V _{DD}
CASE		Tied to Pin 7.

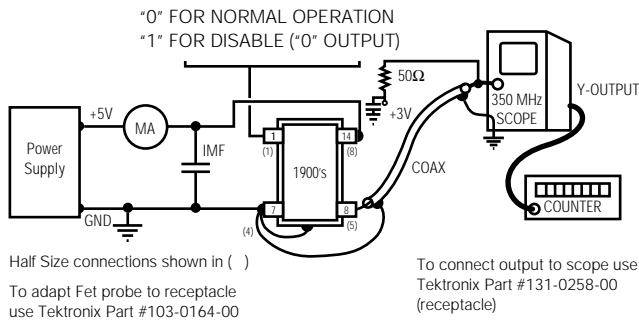

TEST CIRCUIT FOR 1900's

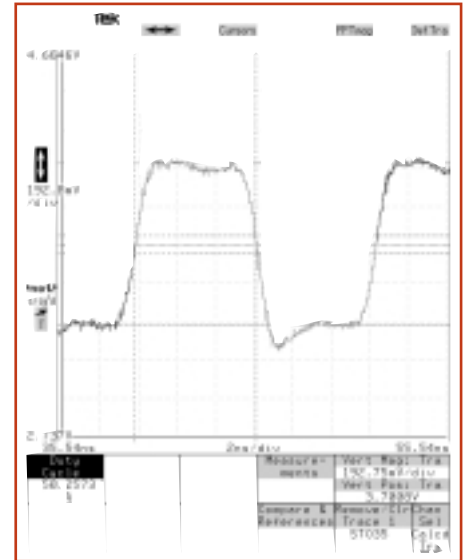
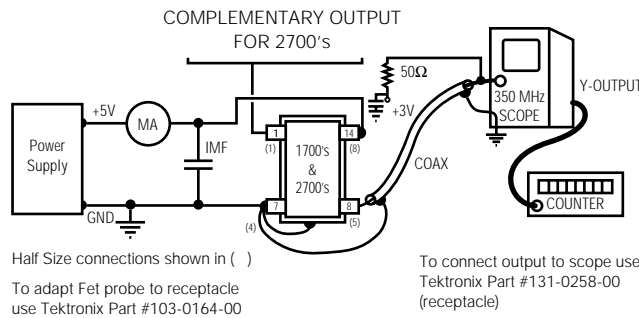

Fig. 3 M1700-80M

TEST CIRCUIT FOR 2700's HAVE ADDITIONAL OUTPUT ON PIN 1.

HOW TO ORDER

For Part Number, put package type before model number, and add frequency in MHz, for example:

M 1700 - 77.76 M

- ↑ "M" is full size DIL
- ↑ "H" is half size DIL
- ↑ "1700" is model type
- ↑ "77.76 M" frequency in MHz
- ↑ Leave blank for straight leads Add "G" for gullwing

SS#	Rev.
M1700	A



Unless customer-specific terms and conditions are signed by an officer of MF Electronics, the sale of this and all MF Electronics products are subject to terms and conditions set forth at www.mfelectronics.com/terms