



PA2460 Power Amplifier IC

Advanced Information

HiMARK Technology, Inc. reserves the right to change the product described in this datasheet. All information contained in this datasheet is subject to change without prior notice. HiMARK Technology, Inc. assumes no responsibility for the use of any circuits shown in this datasheet.

Description

The PA2460 is a Power Amplifier (PA) IC as the final RF amplifier for handheld applications in the 130MHz to 480MHz band.

Features

- ◆ Single 3.5V to 6V Supply Voltage
- ◆ +33dBm Output Power
- ◆ 55% Efficiency
- ◆ 8-pin SOP(FD) package (5mm x 4mm)

Applications

- ◆ FRS, GMRS Handsets
- ◆ Commercial and Consumer Systems
- ◆ Portable Battery-Powered Equipment
- ◆ Long distance Remote Control

Block Diagram

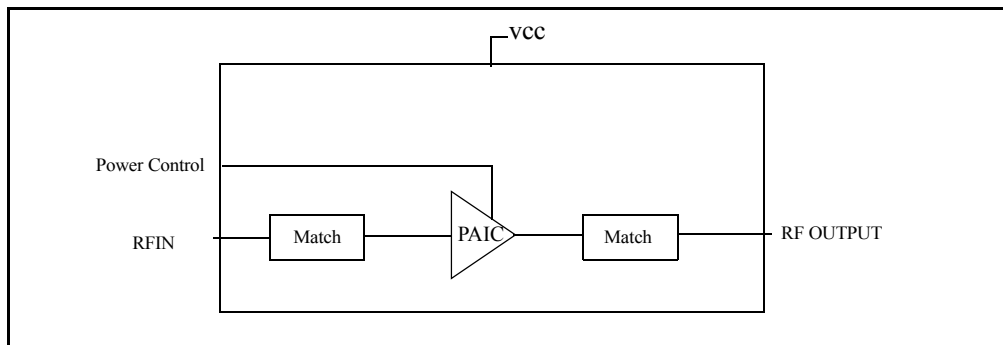

Package and Pin Assignment: 8-Pin SOP(FD)

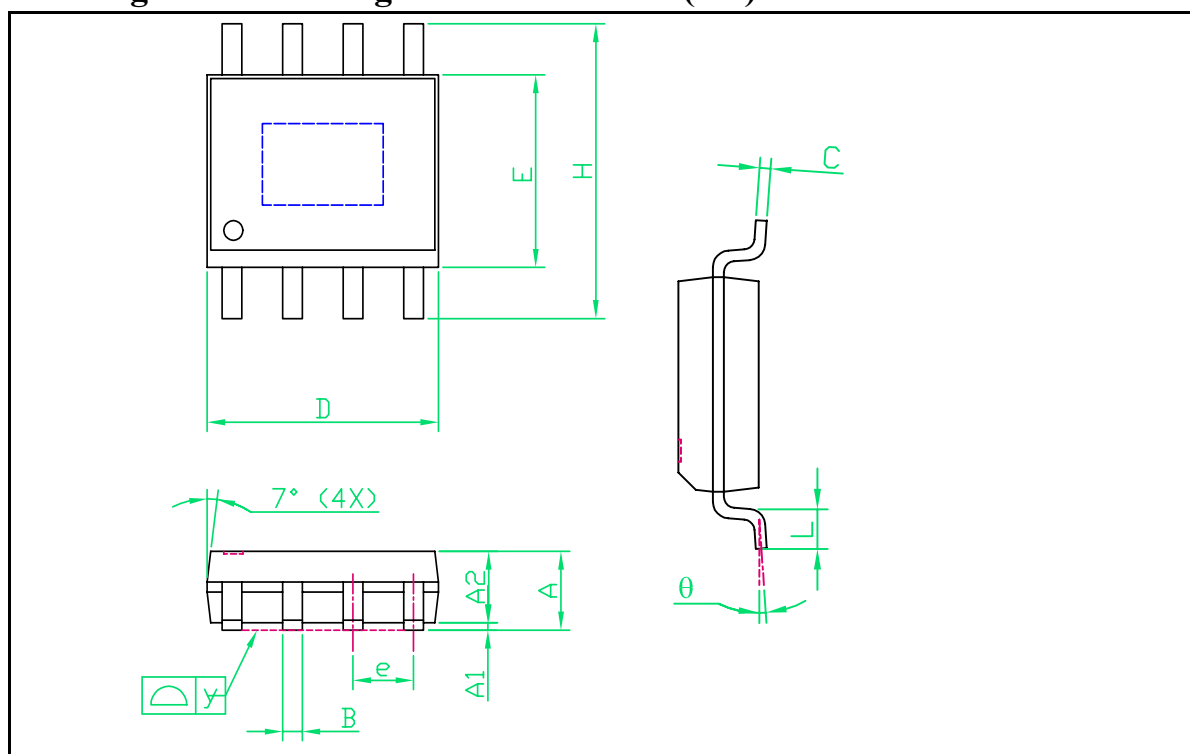

Symbols	Dimensions in mm			Dimensions in inch		
	min.	nom.	max.	min.	nom.	max.
A	1.45	1.50	1.55	0.057	0.059	0.061
A1	0.00	---	0.10	0.000	---	0.004
A2	---	1.45	---	---	0.057	---
B	0.33	---	0.51	0.013	---	0.020
C	0.19	---	0.25	0.007	---	0.010
D	4.80	---	5.00	0.189	---	0.197
E	3.80	---	4.00	0.150	---	0.157
e	---	1.27	---	---	0.050	---
H	5.80	---	6.20	0.228	---	0.244
L	0.40	---	1.27	0.016	---	0.050
y	---	---	0.10	---	---	0.004
theta	0°	---	8°	0°	---	8°

Pin Descriptions

Number	Name	I/O	Description
1	APC1	I	Analog Power Control
2	L1	I	Matching Inductor
3	RF_IN	I	RF input
4	VCC	Power	Power supply for PA
5	L2	I	Matching Inductor
6	RF_OUT	O	RF output
7	RF_OUT	O	RF output
8	APC2	I	Analog Power Control

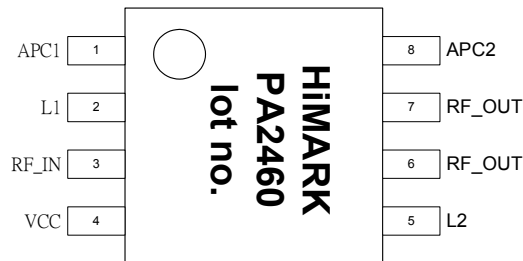

Absolute Maximum Ratings

$$V_{SS} = V_{SS1} = 0 \text{ V}$$

Parameter	Symbol	Rating	Unit
Supply Voltage	V_{CC}	6	V
Supply current	I_{CC}	1000	mA
Input Power	P_{IN}	10	dBm
Operating Temperature Range	T_{OPR}	5 to 100	°C
Storage Temperature Range	T_{STG}	-40 to 125	°C
Soldering Temperature Range	T_{SLD}	255	°C
Soldering Time Range	t_{SLD}	10	s

Recommended Operating Conditions

$$V_{SS} = V_{SS1} = 0 \text{ V}$$

Parameter	Symbol	Value			Unit
		min.	typ.	max.	
Supply Voltage Range	V_{CC}		3.5	6	V
Operating Temperature	T_A	-30	25	85	°C

Electrical Characteristics

($V_{CC} = 3.5V$, $V_{SS} = 0V$, $T_A = 25^\circ C$, $R_L = 50 \Omega$)

Parameter	Symbol	Condition	Value			Unit
			min.	typ.	max.	
VCC Supply Voltage	V_{CC}			3.5	4.8	V
Frequency Range	f		130		480	MHz
Input Power	P_{IN}			5		dBm
Output Power	P_{OUT}	$P_{IN} = 5dBm$		33		dBm
Efficiency		$P_{IN} = 5dBm$	50	55		%
Current Consumption	I	$P_{OUT} = 33dBm, V_{CC} = 3.5V$		1000		mA
Control Voltage Range	V_{APC}		0.2		1.6	V
Full Power Control Voltage		$P_{OUT} = 33dBm$		1.4		V
Control Current into V_{APC}	I_{APC}			30		mA
Isolation		$P_{IN} = 5dBm, APC = 0.2V$	-40	-30		dB
Noise Floor		$P_{IN} = 5dBm, BW = 100kHz,$ $f_o \pm 20MHz$ offset			-84	dBm
2nd to 13th Harmonic Distortion		$P_{OUT} = 33dBm$		-30		dBc
Input VSWR		All power level		1.5:1	2:1	
Output Load VSWR					10:1	
Rise Time and Fall Time		$P_{OUT} = 33dBm$			2	μsec

Electrical Characteristics

($V_{CC} = 6V$, $V_{SS} = 0V$, $T_A = 25^\circ C$, $RL=50\ \Omega$)

Parameter	Symbol	Condition	Value			Unit
			min.	typ.	max.	
VCC Supply Voltage	V_{CC}			6		V
Frequency Range	f		240		480	MHz
Input Power	P_{IN}		-	5	-	dBm
Output Power	P_{OUT}	$P_{IN}=5dBm$	-	33		dBm
Efficiency		$P_{IN}=5dBm$		45		%
Current Consumption	I	$P_{OUT}=33dBm, V_{CC}=6V$		700	900	mA
Control Voltage Range	V_{APC}		0.2		1.3	V
Full Power Control Voltage		$P_{OUT}=33dBm$		1.3		V
Control Current into V_{APC}	I_{APC}			30		mA
Isolation		$P_{IN}=5dBm, APC=0.2V$	-40	-30		dB
Noise Floor		$P_{IN}=5dBm, BW=100kHz,$ $f_{o\pm 20MHz}$ offset			-84	dBm
2nd to 13th Harmonic Distortion		$P_{OUT}=33dBm$		-30		dBc
Input VSWR		All power level		1.5:1	2:1	
Output Load VSWR					10:1	
Rise Time and Fall Time		$P_{OUT}=33dBm$			2	μsec

Output/Input impedance(for reference only)

		Input impedance	Output impedance	
410MHz	6V	26.35-j187.1	8.45-j1.55	
410MHz	3.5V	15.35-j186.7	5.95-j2.70	
465MHz	6V	27.35-j159.3	12.55-j3.45	
465MHz	3.5V	27.35-j159.3	7.3-2.2j	

1. Output impedance: look into PA2460
2. Input impedance: look into PA2460

Evaluation Board Circuit

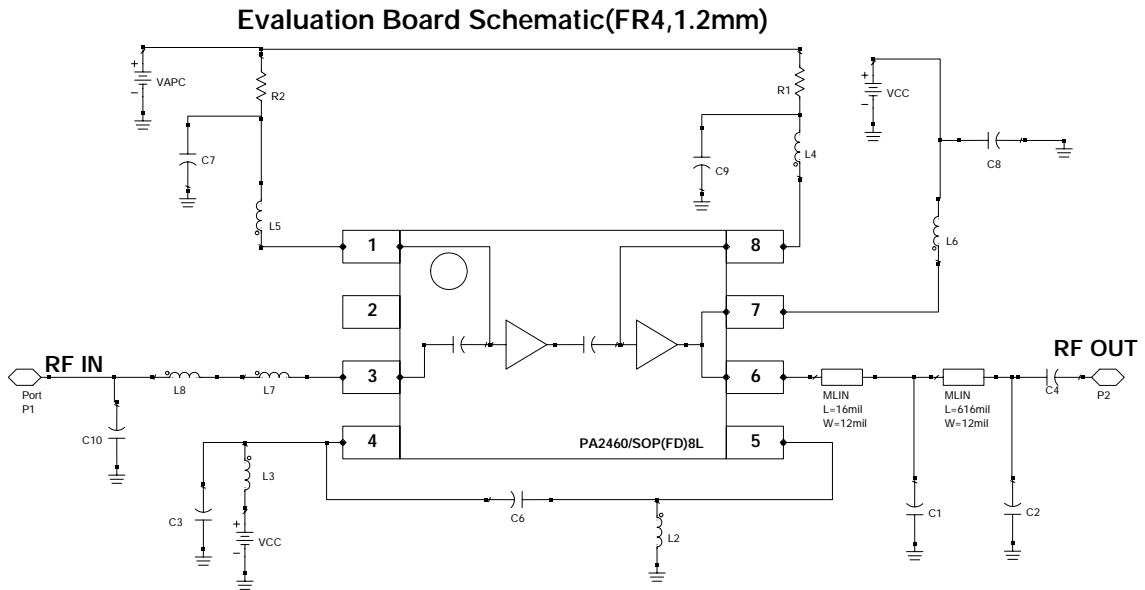

Evaluation Board Layout

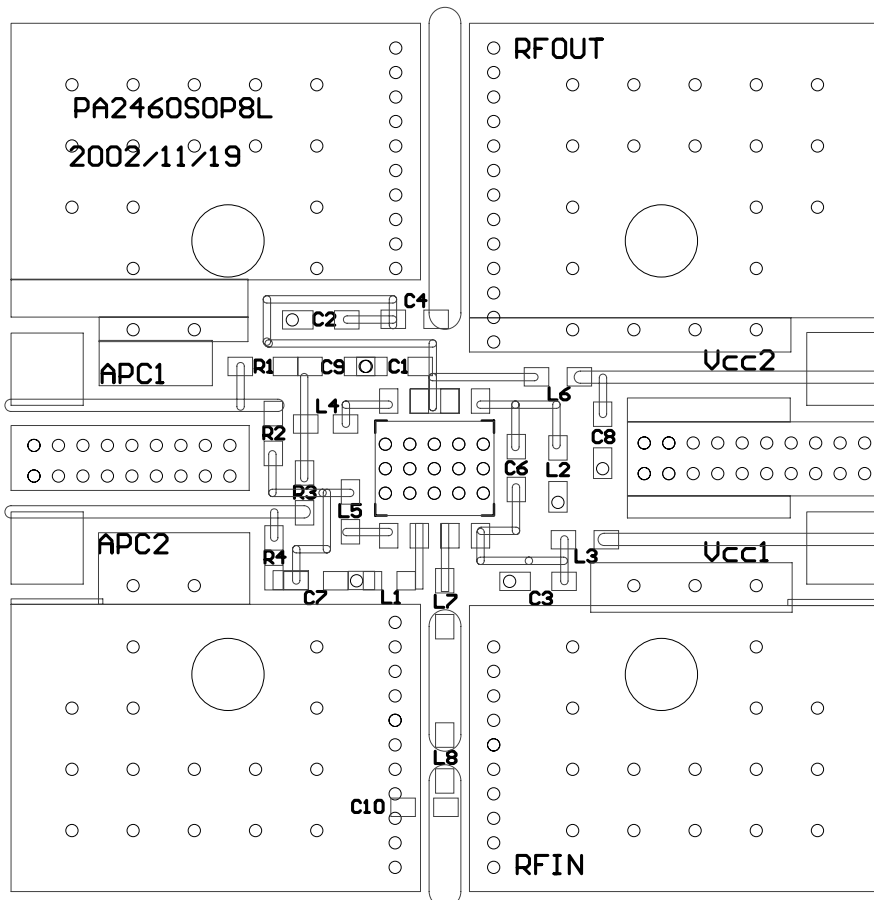

BOM

VCC	3.5V						4.5V			6V		
Freq.	130M	300M	390M	410M	433M	465M	130M	410M	465M	245.5M	410M	465M
Vapc	1.3V	1.4V	1.4V	1.4V	1.4V	1.4V	1.2V	1.3V	1.3V	1.15V	1.3V	1.3V
C1	15pF	10pF	10pF	8pF	6p	4pF	10pF	5pF	4pF	8pF	5pF	4pF
C2	27pF	22pF	11pF	10pF	9p	8pF	27pF	10pF	8pF	27pF	9pF	7pF
C3	X	X	1pF	X	X	X	X	1pF	1pF	6pF	1pF	1pF
C4	100pF	27pF	8pF	6pF	6p	5pF	100pF	10pF	6pF	100pF	8pF	9pF
C6	7pF	10pF	7pF	7pF	8p	10pF	8pF	7pF	10pF	10pF	7pF	10pF
C7	1000pF						1000pF			1000pF		
C8	1000pF						1000pF			1000pF		
C9	1000pF						1000pF			1000pF		
C10	56nH	10pF	10pF	12pF	15p	12pF	56nH	10pF	10pF	12pF	8pF	8pF
L1	X						X			X		
L2	12nH	8.2nH	4.7nH	5.6nH	5.6nH	5.6nH	10nH	3.9nH	3.3nH	X	X	1.8nH
*L3	25nH						25nH			25nH		
L4	270nH	100nH	100nH	100nH	100nH	100nH	270nH	100nH	100nH	100nH	100nH	100nH
L5	270nH	100nH	100nH	100nH	100nH	100nH	270nH	100nH	100nH	100nH	100nH	100nH
*L6	25nH						25nH			25nH		
L7	270nH	100nH	56nH	68nH	10nH	47nH	270nH	68nH	56nH	100nH	68nH	56nH
L8	270nH	39nH	12nH	3.3nH	8.2nH	6.8nH	270nH	4.7nH	X	100nH	8.2nH	4.7nH
R1	0 ohm						0 ohm			0 ohm		
R2	0 ohm						0 ohm			0 ohm		
R3	X						X			X		
R4	X						X			X		

* air coil inductor



Typical Characteristics

410MHz, $V_{cc}=3.5V$, $P_{in}=5dBm$, $V_{apc}=1.4V$

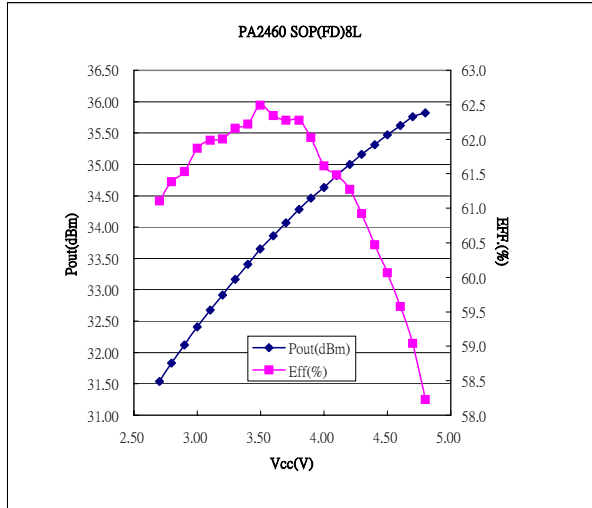

Fig 1.1 Power Output vs. Vcc

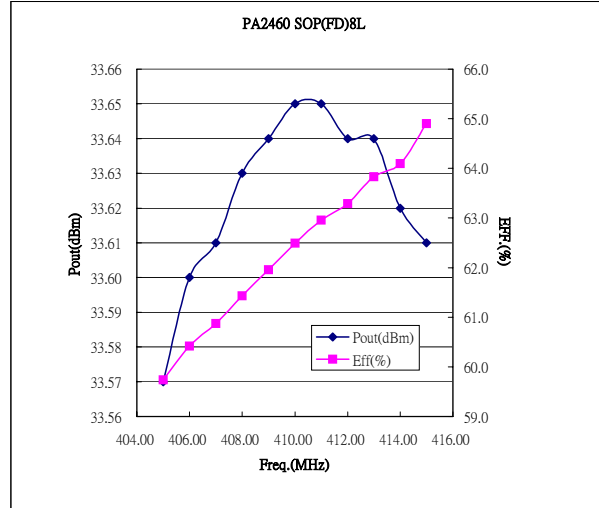

Fig 1.2 Power Output vs. Frequency

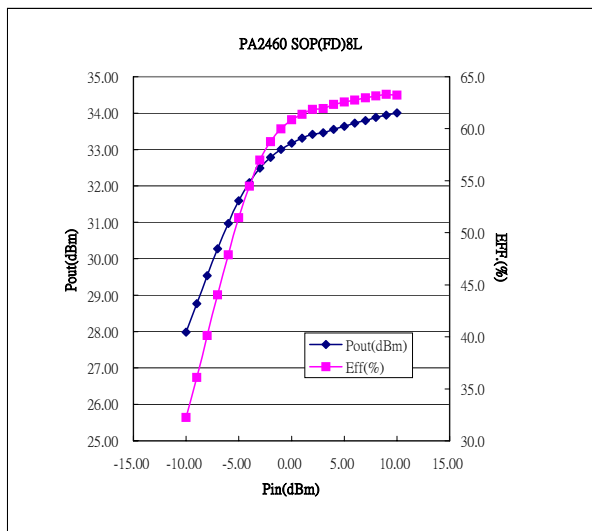

Fig 1.3 Power Output vs. Power Input

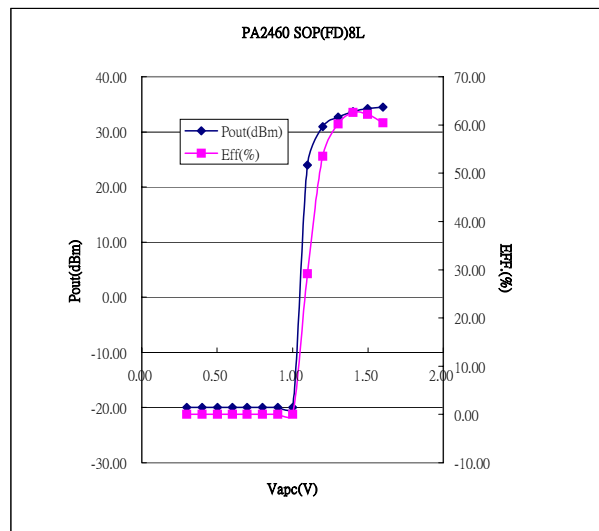

Fig 1.4 Power Output vs. Control Voltage



Typical Characteristics

465MHz, Vcc=3.5V, Pin=5dBm, Vapc=1.4V

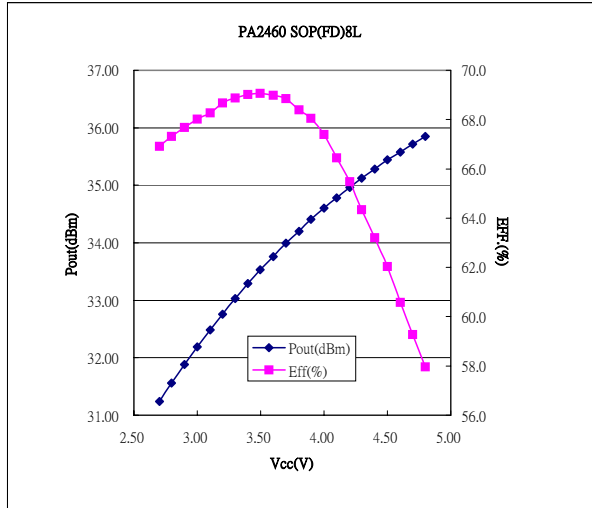

Fig 2.1 Power Output vs. Vcc

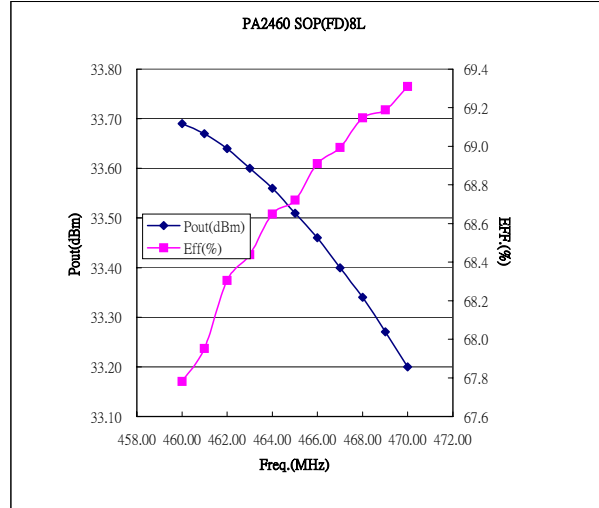

Fig 2.2 Power Output vs. Frequency

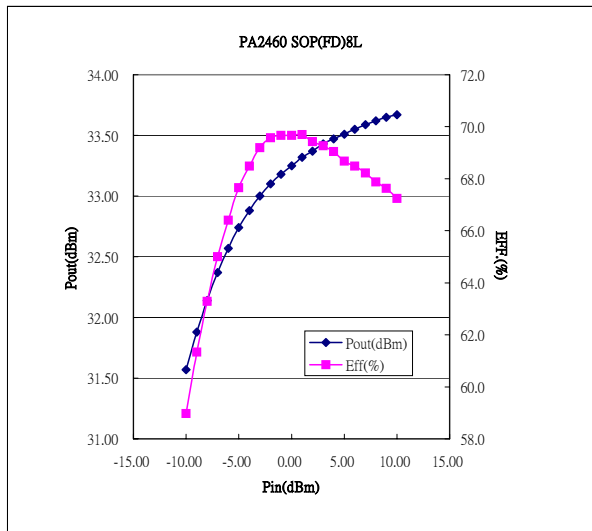

Fig 2.3 Power Output vs. Power Input

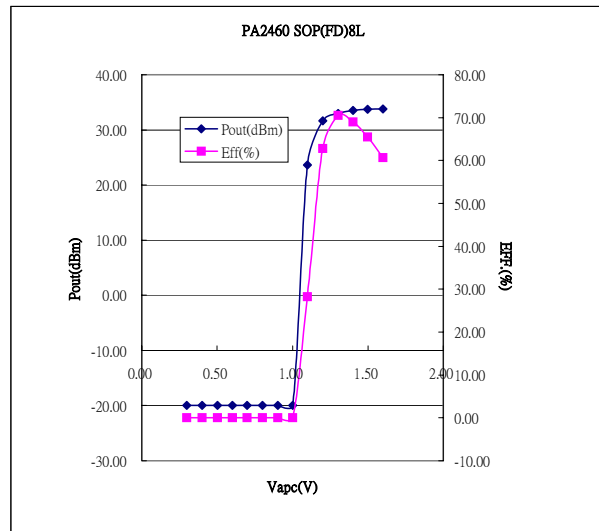

Fig 2.4 Power Output vs. Control Voltage



Typical Characteristics

410MHz, $V_{cc}=6V$, $P_{in}=5dBm$, $V_{apc}=1.3V$

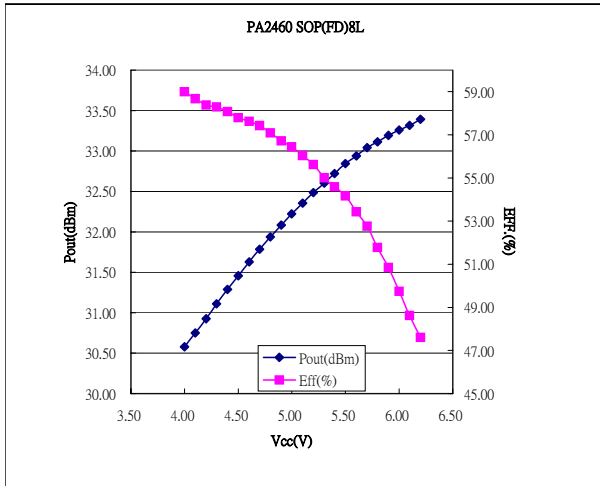

Fig 3.1 Power Output vs. Vcc

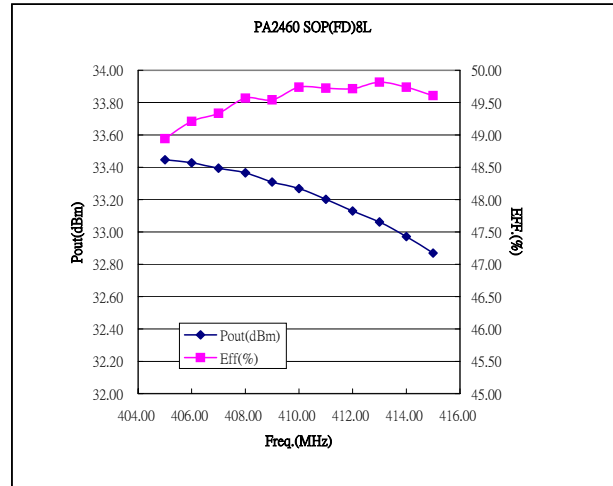

Fig 3.2 Power Output vs. Frequency

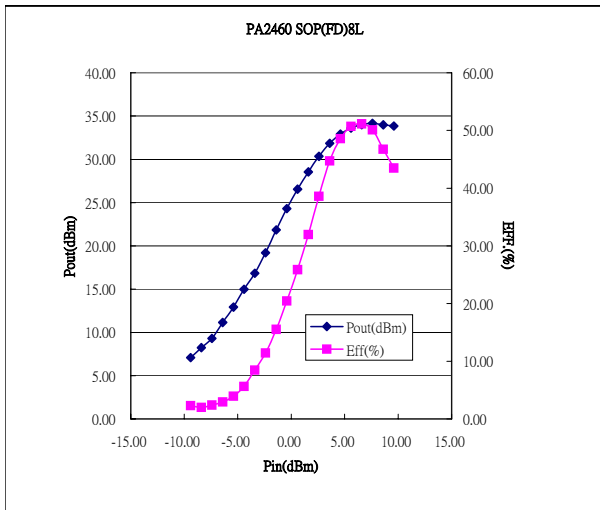

Fig 3.3 Power Output vs. Power Input

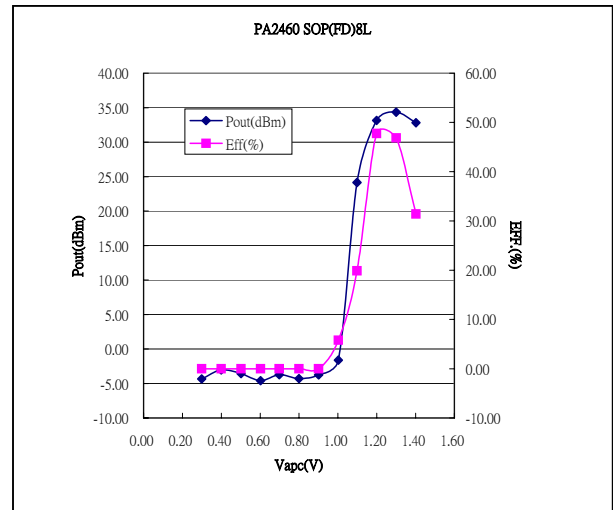

Fig 3.4 Power Output vs. Control Voltage

Typical Characteristics

465MHz, Vcc=6V, Pin=5dBm, Vapc=1.3V

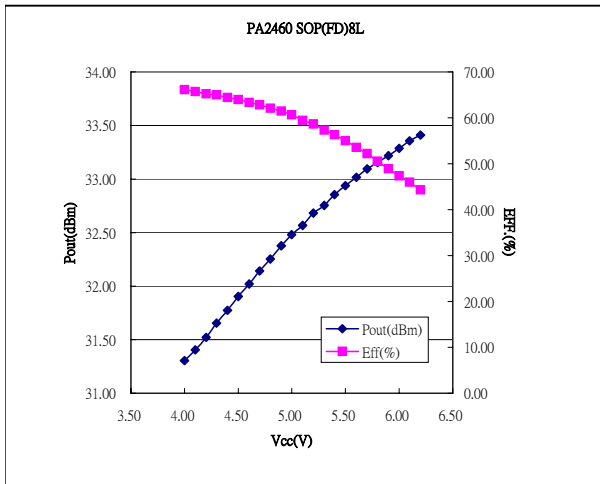

Fig 4.1 Power Output vs. Vcc

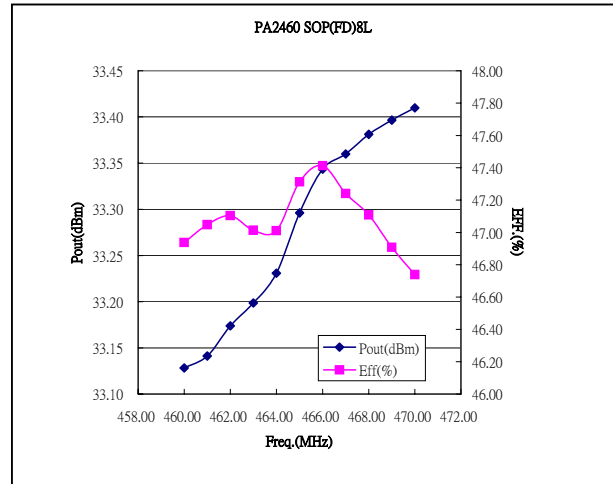

Fig 4.2 Power Output vs. Frequency

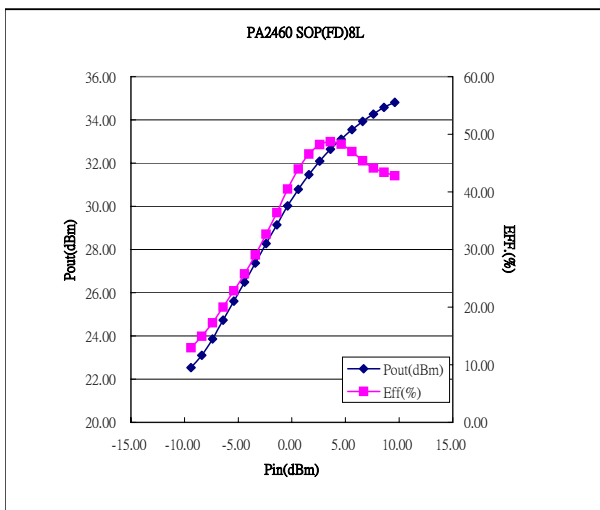

Fig 4.3 Power Output vs. Power Input

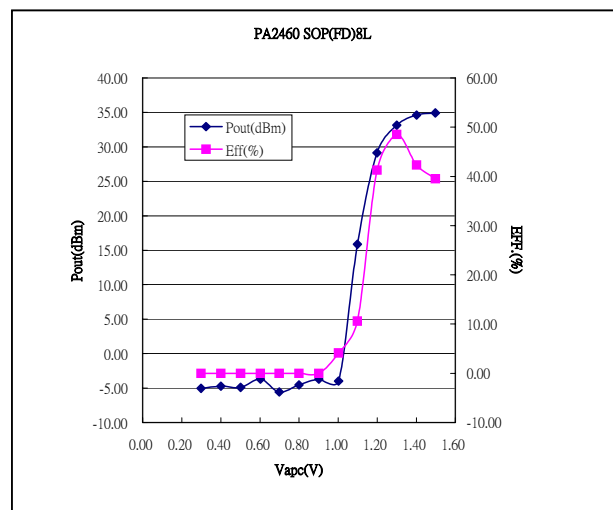

Fig 4.4 Power Output vs. Control Voltage