

OKI

JOB66573

User's Guide

Simple program evaluation board
for MSM66573 family of 16-bit microcontrollers

1st Edition: May, 1999

Oki Electric Industry Co., Ltd.

Notes

1. The contents of this Document are subject to change without prior notice for reasons of product or technological improvement. Before using this Document, make sure that you have the latest edition.
2. The operational descriptions and sample application circuits contained in this Document are meant to illustrate the product's standard operation and use. When using the product for an actual application, therefore, design the circuitry and installation so as to take external conditions into consideration.
3. **Make sure that designs observe the maximum ratings, operating supply voltage range, heat dissipation characteristics, and other guaranteed ranges. Oki Electric Industry shall not be liable for adverse results when the product is operated outside its guaranteed range or in any other incorrect or inappropriate fashion.**
4. Use of this product or information or drawings contained in this Manual does not constitute a warranty or a usage license for any third-party industrial rights, intellectual property rights, or other rights. Oki Electric Industry shall therefore be in no way held responsible for violation of such third-party rights arising from the use thereof.
5. Although every effort has been made to ensure the quality and reliability of the Product, the nature of parts is such that there is a finite, unavoidable risk of defects or breakdown. Equipment and system designs based on Oki Electric Industry products should therefore ensure that such failures do not risk death, personal injury, or property damage.
6. The Product described in this Document is intended for use in the development and evaluation of programs for controlling equipment and systems. Those contemplating use outside this range (e.g., incorporation or attachment to actual equipment) should first contact Oki Electric Industry Sales.
7. The product described in this Manual qualifies as strategic materials under the Foreign Exchange and Foreign Trade Control Law of Japan. The export, in whole or in part, of this product shall therefore require obtaining an export license from the Japanese government under the provision of that Law.
8. Although every reasonable effort has been made to ensure the accuracy of this Manual, please report any errors or discrepancies to your nearest Oki Electric Industry representative.
9. The contents of this Manual shall not be copied or reproduced without the express written permission of Oki Electric Industry.
10. MS-DOS is a registered trademark of Microsoft Corporation.

Contents

1 Read Me First.....	1-1
1.1 Precaution for Safe and Proper Use	1-2
1.2 Important Safety Notes	1-3
1.3 Notation	1-5
1.4 For Further Information.....	1-6
1.5 Verify Package Contents.....	1-7
2 Overview	2-1
2.1 Overview	2-2
2.2 Board Layout	2-3
2.3 Dip Switch and Jumper Pin Settings Prior to Shipping.....	2-7
3 Function	3-1
3.1 System Configuration	3-2
3.2 Memory Map.....	3-3
3.2.1 Download Mode.....	3-3
3.2.2 Application Mode	3-5
3.2.3 Flash Mode.....	3-7
3.3 User Connector (UC1)	3-9
3.4 RS-232C Connector (CN1).....	3-11
3.5 Custom Flashwriter Connector (CN3).....	3-12
3.6 Dip Switch 1 (SW1).....	3-13
3.7 Control EPLD	3-14

3.7.1 Dip Switch 2 (SW5)	3-14
3.7.2 Reset Switch (SW3) and Reboot Switch (SW4)	3-15
3.7.3 Internal Registers of Control EPLD	3-16
3.8 ML60851A.....	3-20
4 Loader.....	4-1
4.1 Setup.....	4-2
4.2 Installation.....	4-3
4.3 Connection	4-4
4.4 Startup	4-5
4.5 Synchronization of Communication Speed	4-6
4.6 How to Use the Loader	4-7
4.7 Example Loader Application.....	4-9

1 Read Me First



This chapter describes the procedures to be followed upon receipt of the JOB66573.

Verify the items described in this chapter before applying power to the JOB66573.

1.1 Precaution for Safe and Proper Use

This User's Guide uses various labels and icons that serve as your guides to operating this product safely and properly so as to prevent death, personal injury, and property damage. The following table lists these labels and their definitions.

Labels

 Warning	This label indicates precautions that, if ignored or otherwise not completely followed, could lead to death or serious personal injury.
 Caution	This label indicates precautions that, if ignored or otherwise not completely followed, could lead to personal injury or property damage.

Icons



A triangular icon draws your attention to the presence of a hazard. The illustration inside the triangular frame indicates the nature of the hazard—in this example, an electrical shock hazard.









A circular icon with a solid background illustrates an action to be performed. The illustration inside this circle indicates this action—in this example, unplugging the power cord.











A circular icon with a crossbar indicates a prohibition. The illustration inside this circle indicates the prohibited action—in this example, disassembly.

1.2 Important Safety Notes

Please read this page before using the product.

 Warning	
<p>Use only the specified voltage. Using the wrong voltage risks fire and electrical shock.</p>	
<p>At the first signs of smoke, an unusual smell, or other problems, unplug the emulator and disconnect all external power cords. Continued use risks fire and electrical shock.</p>	
<p>Do not use the product in an environment exposing it to moisture or high humidity. Such exposure risks fire and electrical shock.</p>	
<p>Do not pile objects on top of the product. Such pressure risks fire and electrical shock.</p>	
<p>At the first signs of breakdown, immediately stop using the product, unplug the emulator, and disconnect all external power cords. Continued use risks fire and electrical shock.</p>	

Please read this page before using the product.

 Caution	
<p>Do not use this product on an unstable or inclined base as it can fall or overturn, producing injury.</p>	
<p>Do not use this product in an environment exposing it to excessive vibration, strong magnetic fields, or corrosive gases. Such factors can loosen or even disconnect cable connectors, producing a breakdown.</p>	
<p>Do not use this product in an environment exposing it to temperatures outside the specified range, direct sunlight, or excessive dust. Such factors risk fire and breakdown.</p>	
<p>Use only the cables and other accessories provided. Using non-compatible parts risks fire and breakdown.</p>	
<p>Always observe the specified order for turning equipment on and off. Using the incorrect order risks fire and breakdown.</p>	
<p>Do not use the cables and other accessories provided with other systems. Such improper usage risks fire.</p>	
<p>Before connecting or disconnecting the cables and the accessories, the power source for the emulator must be turned OFF. Connections or disconnections performed while the power source is ON risk fire and damage to the system.</p>	

1.3 Notation

This manual utilizes the following notational conventions for convenience.

- **Caution** ■ A “caution” indicates a section of the manual that requires special attention.

- **Reference** ■ A “reference” provides information related to the current topic and indicates the page number of a related section of the manual.

- **Application Example** ■ An “application example” indicates an example related to the current topic.

- (note ×) “(note ×)” is a reference to a numbered note that provides supplementary information lower on the same page.

- **Note x** ■ “Note x:” provides supplementary information related to the passage marked with “(note ×).”

1.4 For Further Information

Thank you for purchasing the Oki JOB66573.

Please direct any questions or comments regarding this product to your Oki distributor or the nearest Oki Electric Sales Office.

1.5 Verify Package Contents

Upon receiving the JOB66573, verify that the package contains all the components listed in Table 1.

Although every effort has been made to minimize damage and eliminate mistakes, please report any damaged or missing parts to your Oki distributor or the nearest Oki Electric sales office.

Table 1 Package Contents

Name	Quantity
JOB66573 main unit	1
JOB66573 user's manual (this document)	1
CD-R software that accompanies the JOB66573	1
JOB66573 circuit diagram	1
JOB66573 component list	1
AC adapter	1
RS232C cable (straight wiring)	1

2 Overview

This chapter provides an overview of the JOB66573.

2.1 Overview

The JOB66573 is a simple program evaluation board that is equipped with an Oki original 16-bit MCU of the MSM66573 family.^{note 1}

The JOB66573 has the following special features.

- Equipped with 128K byte program memory, 256K byte data memory, and 256K byte flash memory
- Has a function that uses the host computer's serial port to download application programs
- Equipped with ML60851A, Oki's original USB protocol engine
- With the exception of some ports and signals, connection to a user system is possible

Documents that relate to this manual are listed below.

- MSM66573 Family User's Manual
- ML60851A Data Sheet

■ Note 1 ■

The JOB66573 is equipped with either the MSM66Q573-3V version or the MSM66Q573-5V version.

■ Comment ■

For specifications of the MSM66573 family and the ML60851A, refer to the "MSM66573 Family User's Manual" and the "ML60851A Data Sheet."

2.2 Board Layout

This section shows the JOB66573 board layout and describes each component.

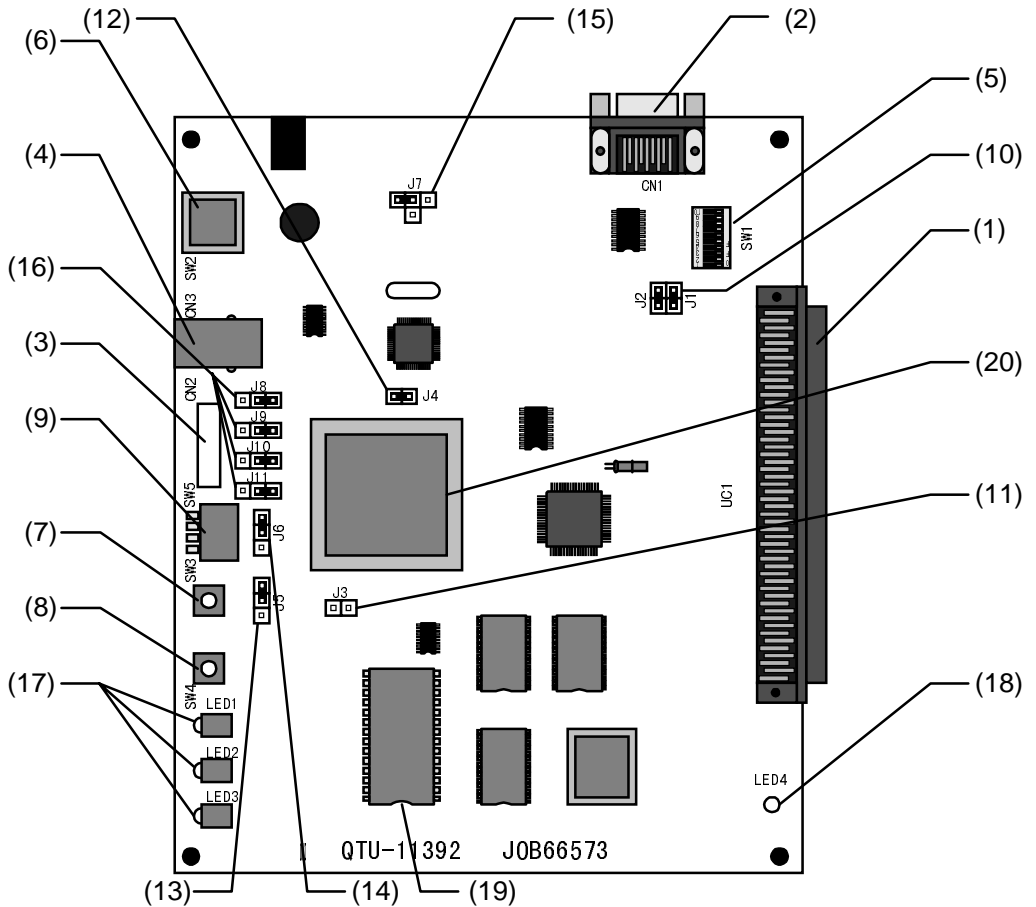

Figure 1 JOB66573 Board Layout

(1) UC1: User connector

Using this connector, each I/O pin of the MSM66573 family device can be connected to an external user application system.

(2) CN1: RS232C connector

The RS-232C connector is connected to serial port 1 of the MSM66573 family device. When an application program is to be downloaded, connect this connector to a personnel computer.

(3) CN2: Custom flashwriter connector

This connector is used to connect a custom flashwriter for writing to the internal flash ROM of the MSM66573 family device. This connector can only be used when a MSM66Q573 (that has internal flash ROM) is installed.

(4) CN3: USB connector

This connector is a right-angled receptacle that conforms to the USB standard type B and is connected to the ML60851A on this board.

(5) SW1: Dip switch 1

This switch sets the input-only port (port 12) of the MSM66573 family device mounted on this board and also sets the A/D converter reference voltage setting pins (VREF, AGND).

Turning the switch ON fixes P12_7 through P12_1 and the AGND pin to 0V (GND), fixes the VREF pin to the Vcc level, and connects the P12_0 pin to the Vbus line of the USB port.

If these ports and pins are to be connected to a user application system, turn the switch OFF.

(6) SW2: Power switch

This switch turns power ON/OFF for the JOB66573.

(7) SW3: Reboot switch

Pressing this switch puts the system in the same state as when power is turned on. When pressed, the memory map is initialized and a system reset is generated for the MSM66573 family device mounted on the board.

(8) SW4: Reset switch

This switch generates a system reset for the MSM66573 family device mounted on the board. Differing from the reboot switch, the memory map is not initialized.

(9) SW5: Dip switch 2

This switch sets the memory map when power is turned on and when the reboot switch is pressed.

(10) J1, J2: Jumper pins 1, 2

These jumper pins enable/disable hardware flow control based on the RTS/CTS signal of the RS232C port.

(11) J3: Jumper 3

This jumper pin enables/disables the memory map control function of the JOB66573.

(12) J4: Jumper 4

This jumper pin sets the ADSEL pin (pin no. 24) of the ML60851A. Always short this jumper.

(13) J5: Jumper 5

This jumper pin selects whether the reset signal (/RES, pin no. 32) of the MSM66573 family device mounted on this board is connected to either SW3 or UC1 pin 32.

(14) J6: Jumper 6

This jumper pin selects whether the /EA pin (pin no. 34) of the MSM66573 family device mounted on this board is connected to either SW5-1 or UC1 pin 34.

(15) J7: Jumper 7

This jumper pin selects whether the power supplied to the MSM66573 family device is connected to 3.3V, 5V or UC1 (pin 80).

(16) J8 to J11: Jumper pins 8 to 11

These jumper pins set the operating mode of the MSM66573 family device mounted on this board to either the normal mode or the internal flash ROM write mode in which the ROM is programmed by a custom writer.

(16) LED1 to LED3: Green, yellow, red LEDs

These LEDs can be controlled from the MSM66573 family device mounted on this board.

(16) LED4: Power status LED

This LED indicates the state of the JOB66573 power source. This LED is lit when power is being supplied to the JOB66573.

(16) U4: EPROM

A program known as a “loader” is written to the EPROM. Using the loader, application programs can be downloaded from the host computer to the JOB66573 and debugged. For details of the loader, refer to Chapter 4.

(16) U9: Control EPLD

Controls each type of function of the JOB66573.

2.3 Dip Switch and Jumper Pin Settings Prior to Shipping

The dip switch and jumper pin settings prior to shipping are listed below.

Table 2 Dip Switch and Jumper Pin Settings Prior to Shipping

Dip switch 1	All ON
Dip switch 2	Only 1 ON, all others OFF
J1, 2	1-2 pin short
J3	Open
J4	1-2 pin short
J5, 6	2-3 pin short
J7	If MSM66Q573-3V is installed: 2-3 pin short Otherwise: 1-2 pin short
J8 to 11	2-3 pin short

3 Function

This chapter describes the function of the JOB66573.

3.1 System Configuration

A block diagram of the JOB66573 is shown below.

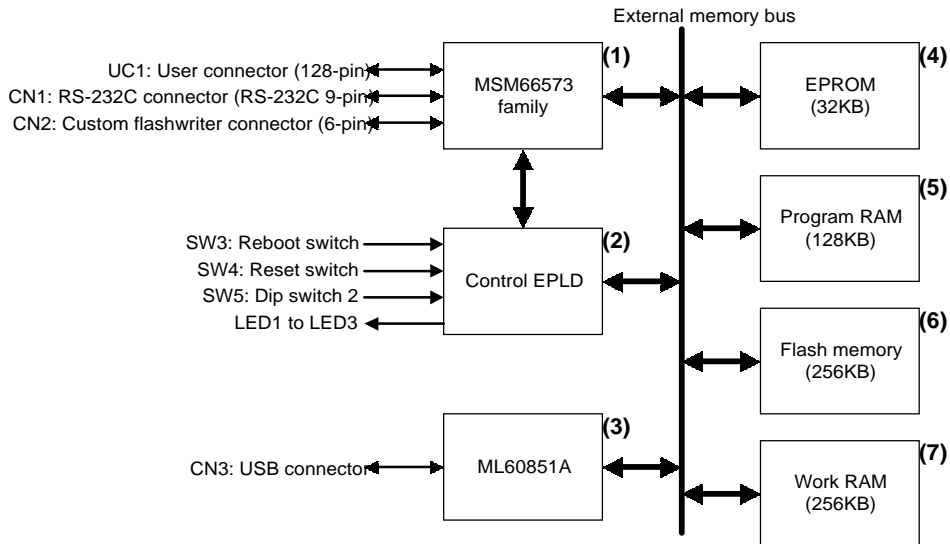

Figure 2 JOB66573 Block Diagram

As shown in Figure 2, the following devices are connected onboard the JOB66573 as external memory devices for the MSM66573 family device: control EPLD, EPROM, program RAM, flash memory, work RAM, and a ML60851A.

The JOB66573 has three memory map modes (download mode, application mode, and flash mode) for assigning these devices to the MSM66573 family device.

Control of the memory map is performed by the control EPLD.

Of course, these three memory map modes can be switched by SW5. They can also be switched by controlling the control EPLD from the application program.

3.2 Memory Map

Mapping of the program data space and data memory space for each memory map mode of the JOB66573 is described below.

3.2.1 Download Mode

In this mode, the code memory space is mapped to EPROM, and the data memory space is mapped to program RAM and flash memory.

This mode uses an EPROM program for downloading (hereafter referred to as the loader) to download application programs from the host PC to the program RAM or flash memory via a serial transfer.

Refer to Chapter 4 for instructions regarding loader usage.

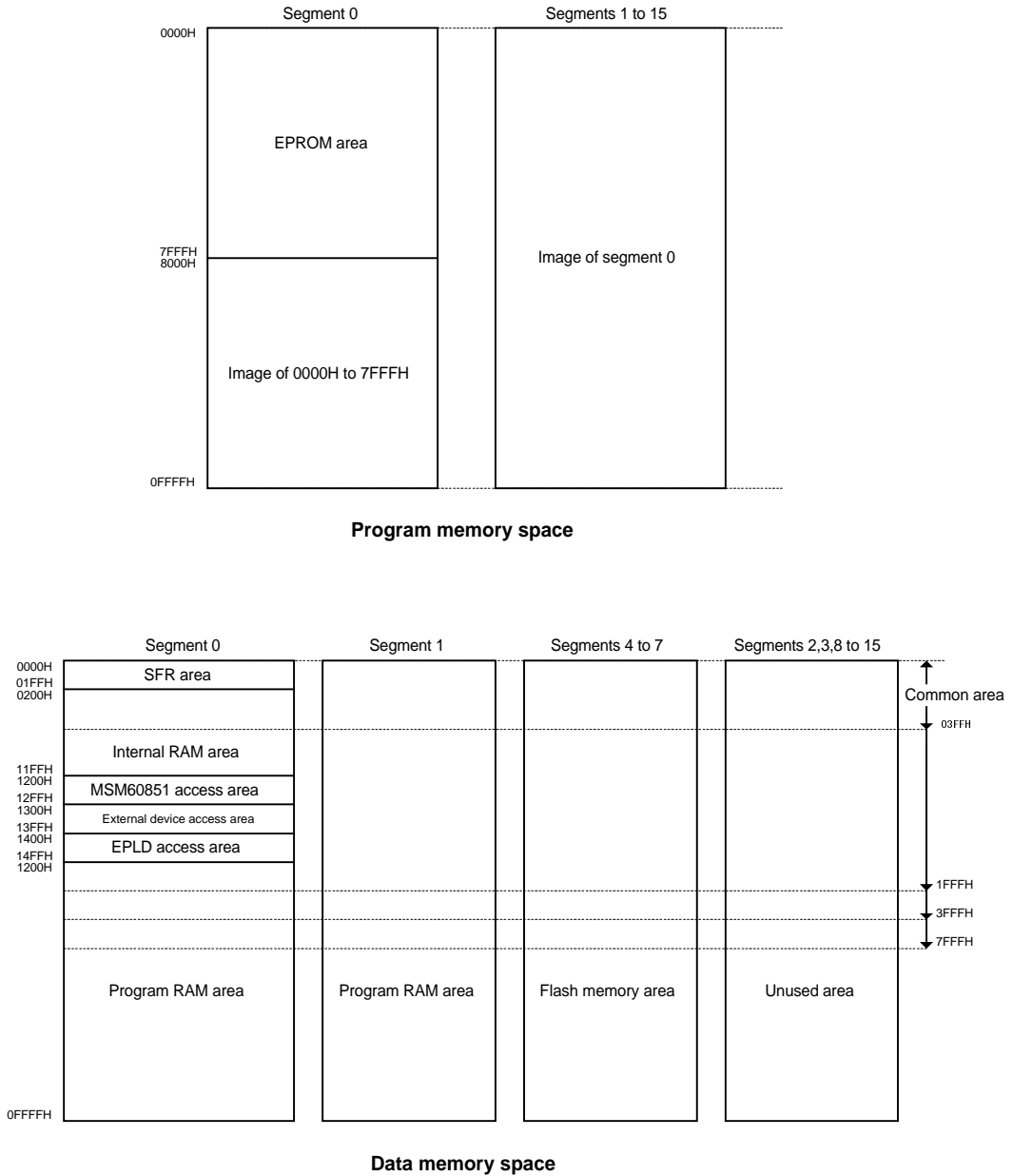

Figure 3 Memory Map During Download Mode

3.2.2 Application Mode

In this mode, the code memory space is mapped to program RAM, and the data memory space is mapped to work RAM and flash memory.

This mode is used to execute application programs already downloaded to program RAM.

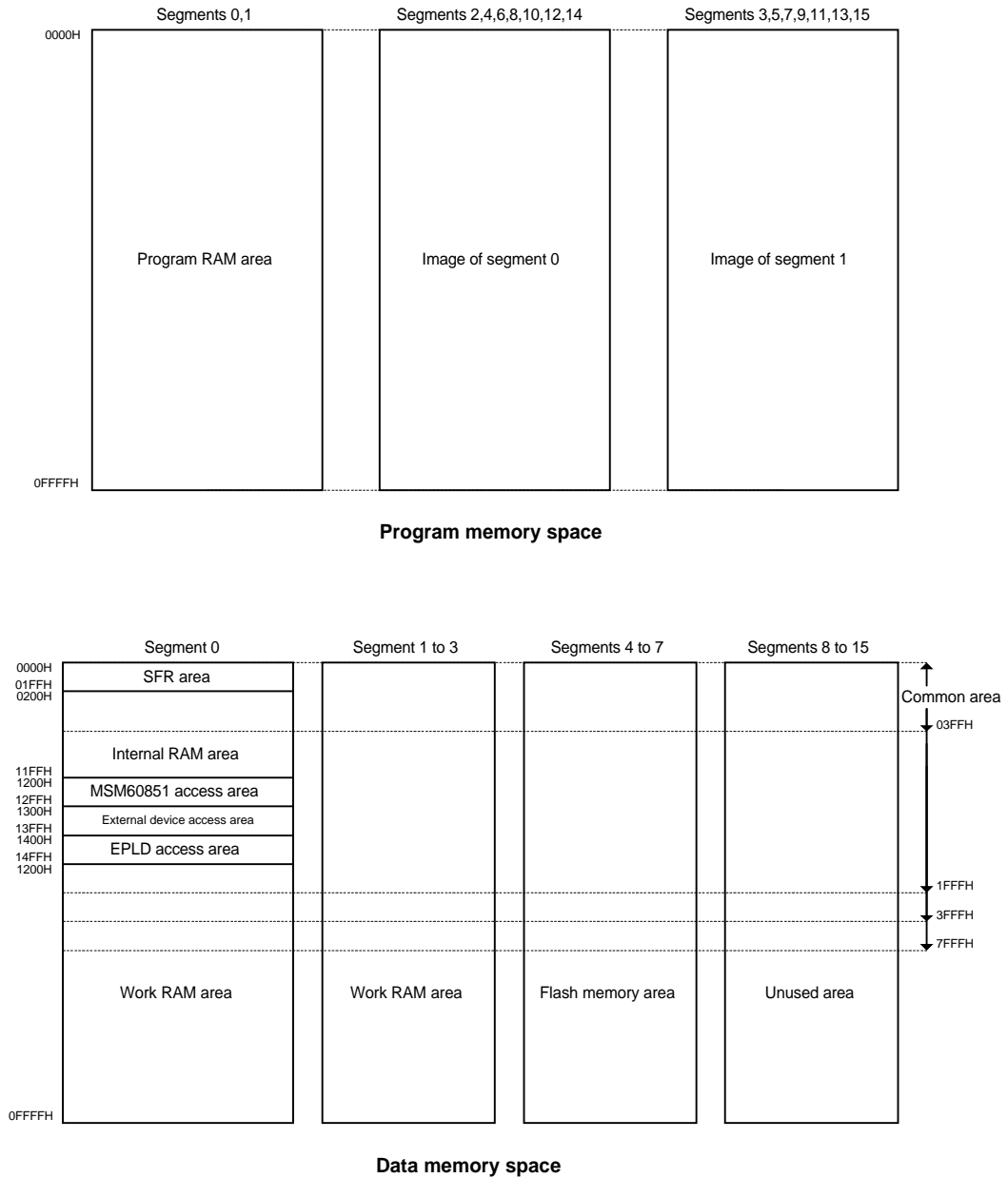

Figure 4 Memory Map During Application Mode

3.2.3 Flash Mode

In this mode, the code memory space is mapped to flash memory, and the data memory space is mapped to work RAM.

This mode is used to execute application programs that have been downloaded to flash memory.

Once a program has been downloaded to flash memory, that program can be started at the same time as power is turned on.

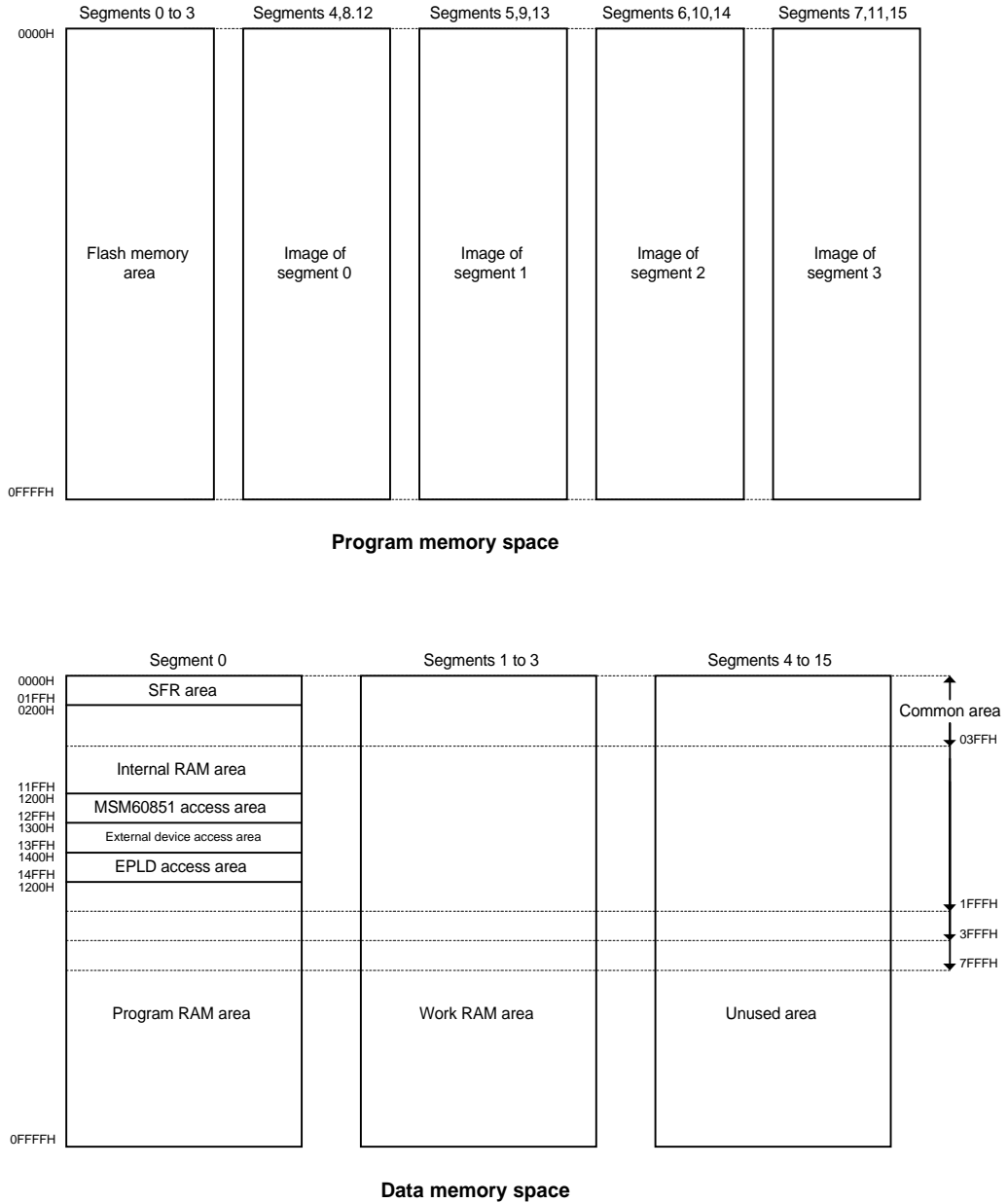

Figure 5 Memory Map During Flash Mode

3.3 User Connector (UC1)

The JOB66573 is equipped with a 1ch connector (UC1) that interfaces between the MSM66573 family device mounted on the board and the user application system.

The manufacturer and model number of the corresponding connector prepared on the user application system is listed below.

Manufacturer: Hirose Electric, K.K.

Model number: PCN10-128P-2.54DS

Except for the XT0 (pin no. 36), XT1/ (pin no. 37), OSC0 (pin no. 39), and OSC1/ (pin no. 40) pins, all the pins of the MSM66573 family device are connected to this connector.

Table 3 shows the pin assignment of the user connector.

Table 3 User Connector (UC1) Pin Assignment

User Connector (UC1) Pin Assignment							
Pin.No.	Pin name	Pin.No.	Pin name	Pin.No.	Pin name	Pin.No.	Pin name
1	P10_4	33	NMI	65	P4_5	97	P10_0
2	P10_5	34	U.EA/	66	P4_6	98	P10_1
3	P10_7	35	U.VDD	67	P4_7	99	P10_2
4	P8_0	36	N.C	68	P1_0	100	P10_3
5	P8_1	37	N.C	69	P1_1	101	EXT_CS
6	P8_2	38	GND	70	P1_2	102	GND
7	P8_3	39	N.C	71	P1_3	103	GND
8	P8_4	40	N.C	72	P1_4	104	GND
9	P8_6	41	U.VDD	73	P1_5	105	GND
10	P8_7	42	P11_0	74	P1_6	106	GND
11	P7_6	43	P11_1	75	P1_7	107	GND
12	P7_7	44	P11_2	76	P2_0	108	GND
13	U.VDD	45	P11_3	77	P2_1	109	3.3V
14	GND	46	P11_6	78	P2_2	110	3.3V
15	P9_7	47	P11_7	79	P2_3	111	3.3V
16	P9_0	48	P3_1	80	U.VDD	112	3.3V
17	P9_1	49	P3_2	81	VREF	113	GND
18	U.P9_2	50	P3_3	82	P12_0	114	GND
19	U.P9_3	51	P0_0	83	P12_1	115	GND
20	P6_0	52	P0_1	84	P12_2	116	GND
21	P6_1	53	P0_2	85	P12_3	117	GND
22	P6_2	54	P0_3	86	P12_4	118	GND
23	P6_3	55	P0_4	87	P12_5	119	GND
24	P6_4	56	P0_5	88	P12_6	120	GND
25	P6_5	57	P0_6	89	P12_7	121	5V
26	P6_6	58	P0_7	90	AGND	122	5V
27	P6_7	59	GND	91	P7_0	123	5V
28	P5_4	60	P4_0	92	P7_1	124	5V
29	P5_5	61	P4_1	93	GND	125	GND
30	P5_6	62	P4_2	94	P7_2	126	GND
31	P5_7	63	P4_3	95	P7_4	127	GND
32	RES/	64	P4_4	96	P7_5	128	GND

3.4 RS-232C Connector (CN1)

This connector allows communication with the host computer using serial port 1 (secondary function of bits 1 and 0 of port 8) of the MSM66573 family device.

This connector is used for such purposes as to download application programs from the host computer to the JOB66573.

Table 4 lists the pins used with the RS-232C connector.

Table 4 Pins used with RS-232C Connector (CN1)

Pin No.	Signal Name	Description
3	RXD	This is the asynchronous serial receive data signal, and is assigned to RXD1 (secondary function of port 8.0) of the MSM66573 family device. If this pin is to be used, the baud rate and secondary function of port 8.0 must be set.
2	TXD	This is the asynchronous serial transmit data signal, and is assigned to TXD1 (secondary function of port 8.1) of the MSM66573 family device. If this pin is to be used, the baud rate and secondary function of port 8.1 must be set.
7	RTS	This is an asynchronous serial control signal and is assigned to port 8.2 of the MSM66573 family device. If this pin is to be used, port 8.2 must be set as an input and software control is necessary.
8	CTS	This is an asynchronous serial control signal and is assigned to port 8.3 of the MSM66573 family device. If this pin is to be used, port 8.3 must be set as an output and software control is necessary.

3.5 Custom Flashwriter Connector (CN3)

This connector is compatible with MSM66573 family devices that have internal flash ROM (such as the MSM66Q573), connects to a custom Oki flashwriter adapter (flashwriter, FW66500S series), and is used with the onboard flash ROM write function (serial mode).

If the custom flashwriter connector is to be connected to the flashwriter, short the 1-2 pins of jumpers J8 to J11.

If the flashwriter is not connected, short the 2-3 pins of jumpers J8 to J11.

3.6 Dip Switch 1 (SW1)

If the input-only port (port 12) of the MSM66573 family device mounted on the JOB66573 and the A/D converter reference voltage setup pins (VREF, AGND) are not used with the user application system, this switch is used to process the onboard input level.

If port 12 is not used with the user application system, turn this switch entirely ON.

3.7 Control EPLD

The following functions are controlled with the control EPLD.

- Memory map
- EA/
- System reset
- LED1 to LED3
- Pull-up of USB D+ line
- A15 line mask

3.7.1 Dip Switch 2 (SW5)

Dip switch 2 (SW5) sets the memory map and the EA/ pin (pin no. 34) of the MSM66573 family device when power is turned on and when the reboot switch is pressed (SW4).

3.7.1.1 Memory Map Control

SW5-2 and SW5-3 set the memory map when power is turned on and when the reboot switch is pressed.

Table 5 Relation Between SW5-2, SW5-3 and Memory Map

SW5-2	SW5-3	Memory map
OFF	—	Download mode (set prior to shipping)
ON	ON	Application mode
ON	OFF	Flash mode

3.7.1.2 EA/Pin Control

SW5-1 sets the EA/ pin when power is turned on and when the reboot switch is pressed.

Table 6 Relation Between SW5-1 and EA/ Pin

SW5-1	EA/ pin level
ON	“L” (set prior to shipping)
OFF	“H” ^{note 1}

■ **Note 1** ■

Regardless of the memory mapped state, internal ROM will be mapped to segment 0 of the program memory space of the MSM66573 family device.

3.7.2 Reset Switch (SW3) and Reboot Switch (SW4)

System reset of the JOB66573 can be implemented by the reset switch (SW3) and by the reboot switch (SW4). The difference between these two switches is indicated below.

Table 7 Differences Between Reset Switch and Reboot Switch

Switch	Memory map	Devices that are reset
Reset switch	No change	MSM66573, ML60851A
Reboot switch	Reflects contents of SW5	MSM66573, ML60851A, Control EPLD

3.7.3 Internal Registers of Control EPLD

Internal registers of the control EPLD are mapped to segment 0 of the data memory space of the MSM66573 family device.

The address mapping of the internal registers of the control EPLD and the function of those registers are described below.

Table 8 Address Mapping of Control EPLD Internal Registers

Address	Register name	Initial value	Function
1400h	Reset register 0 (JOBRES0)	0FFh	(during a read) reads current memory map (during a write) controls reset and memory map
1410h	Reset register 1 (JOBRES1)	Depends upon SW5	(during a read) reads SW5 status (during a write) controls reset and memory map
1420h	Control register (JOBCTRL)	0FFh	Sets LED1 through LED3, USB D+ line pull-up, A15 line mask, and reads current status

0x1400 JOBRES0 Read							
Bit7	6	5	4	3	2	1	0
"1"	"1"	"1"	"1"	"1"	CEAR	CMMR	

CMMR : current value of memory map register
 00 : application mode
 01 : flash mode
 10 or 11 : download mode

CEAR : current value of EA/ pin register
 0 : EA/ pin "H"
 1 : EA/ pin "L"

0x1400 JOBRES0 Write							
Bit7	6	5	4	3	2	1	0
"1"	"1"	"0"	"0"	"1"	SEAR	SMMR	

SMMR : value desired to be set in memory map register
 00 : application mode
 01 : flash mode
 10 or 11 : download mode

SEAR : value desired to be set in /EA pin register
 0 : EA/ pin "H"
 1 : EA/ pin "L"

0x1410 JOBRES1 Read							
Bit7	6	5	4	3	2	1	0
"1"	"1"	"1"	"1"	"1"	SW5		

SW : SW5 status
 0 : ON
 1 : OFF
 Bit0: SW5-3

Bit1: SW5-2

Bit2: SW5-1

0x1410 JOBRES1 Write							
Bit7	6	5	4	3	2	1	0
"0"	"0"	"1"	"1"	"1"	UMMR	SR0	SRES

UMMR : update memory map register and EA/ pin register

0 : do not update

1 : update

SR0 : value to be set in memory map register and EA/ pin register

0 : SW5 status

1 : value set in reset register 0

SRES : issuance of a system reset

0 : do not issue system reset

1 : issue system reset

0x1420 JOBCTRL Read, Write							
Bit7	6	5	4	3	2	1	0
A15M	UPUP	"1"	"1"	"1"	LED3	LED2	LED1

LED1 : LED1 (green) control

0 : lit

1 : unlit

LED1 : LED2 (yellow) control

0 : lit

1 : unlit

LED1 : LED3 (red) control

0 : lit

1 : unlit

UPUP : USB D+ line pull-up

0 : pull-up

1 : no pull-up

A15M	:	A15 (P1_7) mask
0	:	mask
1	:	do not mask

■ **Note** ■

Write to JOBRES0 and JOBRES1 consecutively and in the order of JOBRES0, JOBRES1.

3.8 ML60851A

The address mapping of each internal register of the ML60851A is listed below.

Table 9

ML60851A Internal Register Address List		
Address		Register name
During READ	During WRITE	
0x12c0	0x1240	Device address register
0x12c1	0x1241	Device state register
0x12c2	-	Packet error register
0x12c3	-	FIFO status register 1
0x12c4	-	FIFO status register 2
0x12c8	0x1248	Endpoint packet ready register
0x12c9	-	Endpoint 0 receive byte count register
0x12ca	-	Endpoint 1 receive byte count register
0x12cb	-	Endpoint 2 receive byte count register
-	0x124e	Transmit FIFO clear register
-	0x124f	System control register
0x12d0	-	bmRequest Type setup register
0x12d1	-	bRequest setup register
0x12d2	-	wValue LSB setup register
0x12d3	-	wValue MSB setup register
0x12d4	-	wIndex LSB setup register
0x12d5	-	wIndex MSB setup register
0x12d6	-	wLength LSB setup register
0x12d7	-	wLength MSB setup register
0x12da	0x125a	Polarity select register
0x12db	0x125b	Interrupt enable register
0x12dc	-	Interrupt status register
0x12dd	0x125d	DMA control register
0x12de	0x125e	DMA interval register
0x12e0	-	Endpoint 0 receive control register
0x12e1	-	Endpoint 0 receive data toggle register
0x12e2	0x1262	Endpoint 0 receive payload register
0x12e4	0x1264	Endpoint 1 control register
0x12e5	0x1265	Endpoint 1 data toggle register
0x12e6	0x1266	Endpoint 1 payload register
0x12f0	-	Endpoint 0 transmit control register
0x12f1	-	Endpoint 0 transmit data toggle register
0x12f2	0x1272	Endpoint 0 transmit payload register
0x12f3	0x1273	Endpoint 0 status register

ML60851A Internal Register Address List		
Address		Register name
During READ	During WRITE	
0x12f4	0x1274	Endpoint 2 control register
0x12f5	0x1275	Endpoint 2 data toggle register
0x12f6	0x1276	Endpoint 2 payload register
0x12f8	0x1278	Endpoint 3 control register
0x12f9	0x1279	Endpoint 3 data toggle register
0x12fa	0x127a	Endpoint 3 payload register
0x1240	-	Endpoint 0 receive FIFO data
0x1241	-	Endpoint 1 receive FIFO data
0x1242	-	Endpoint 2 receive FIFO data
-	0x12c0	Endpoint 0 transmit FIFO data
-	0x12c1	Endpoint 1 transmit FIFO data
-	0x12c2	Endpoint 2 transmit FIFO data
-	0x12c3	Endpoint 3 transmit FIFO data

4 Loader

The JOB66573 comes equipped with an EPROM containing a program known as a “loader.”

This chapter describes how to use the loader to debug an application program on the JOB66573.

4.1 Setup

After verifying that SW2 is OFF, set each switch and jumper pin as follows.

Table 10 Switch and Jumper Pin Settings

SW1	All ON
SW5	SW5-1 is ON, all others are OFF
J1,J2,J4	1-2 pin short
J3	Open
J7 to 11	2-3 pin short

4.2 Installation

Copy the contents of the accompanying floppy disk to an arbitrary directory on the host computer's hard drive.

If the accompanying terminal software is to be used, run it from the directory to which it was copied.

If terminal software other than the accompanying terminal software is to be used, the !ZERO.DAT file on the accompanying floppy disk is still necessary. Copy that file to the hard drive.

4.3 Connection

Connect the host computer's RS232C connector and the JOB66573's RS232C connector (CN1) with the provided RS232C cable.

Connect the JOB66573's AC adapter jack (DC1) to the provided AC adapter and plug the AC adapter into an AC outlet.

4.4 Startup

Press the JOB66573's power switch (SW2) to turn on the power. Verify that LED4 is lit.

When the loader initialization is correctly completed, LED3 will become lit. If LED3 does not become lit, press the reboot switch (SW4) several times.

After verifying the startup of the JOB66573, activate the terminal software on the host computer.

Set the communication parameters of the terminal software as follows.

Table 11 Terminal Software Communication Parameters

Communication speed	Arbitrary
Data length	8 bits
Stop bit length	2 bits
Parity bit	None
Flow control	Hardware flow control (RTS/CTS)

If the JOB66573 and host computer have been correctly connected, LED2 will now become lit.

4.5 Synchronization of Communication Speed

To align the communication speed of the JOB66573 with that of the terminal software, perform a non-procedural (text) transmission of the !ZERO.DAT file (that was on the accompanying floppy disk) from the terminal software to the JOB66573.

If synchronization of the communication speed is successful, LED2 and LED3 of the JOB66573 will become unlit, LED1 will become lit, and the loader menu will be displayed on the terminal software screen.

If synchronization of the communication speed fails, LED1 may not become lit and there may be no display or a character string other than the loader menu will be displayed.

In the case of a failure, after pressing the reboot switch (SW4), change the communication speed of the terminal software and then once again perform a non-procedural (text) transmission of the !ZERO.DAT file.

4.6 How to Use the Loader

The loader has seven functions.

Each function can be used by inputting the number of the corresponding function at the loader's main menu.

Each function is described below.

Function 0: Reset & Change Memory Map

This function changes the memory map register of the control EPLD of the JOB66573 and resets the software.

Specify the memory map desired to be changed with a number from 0 to 7.

Numbers have the following meanings.

0	: application mode
1	: flash mode
2, 3	: download mode
4+	: set EA/ pin to "H" level

For example, to set the EA/ pin to a "H" level and to set the flash mode, specify the number 5.

Function 1: Change ROMRDY

This function changes the value of ROMRDY of the MSM66573 family device.

Function 2: Change RAMRDY

This function changes the value of RAMRDY of the MSM66573 family device.

Wait values of 0 to 7FFFH are the same as value of 8000H to 0FFFFH.

Function 3: Download to Program RAM

This function downloads an application program to the program RAM.

Compatible file formats are listed below.

Intel HEX

Intel Symbolic HEX

Motorola S2 Record

Function 4: Download to FLASH Memory

This function downloads an application program to the flash memory.

Compatible file formats are the same as those for function 4.

If downloading is not possible because a program has already been written to the flash memory, use function 5 to clear the flash memory.

Function 5: Clear Flash Memory

This function clears the entire contents of the flash memory.

Approximately 15 seconds are required for a clear operation.

Function 6: Clear & Test Data Memory Area

This function clears to 0 and tests data memory.

If an error occurs during this test, change the value of ROMRDY and RAMRDY and then insert a WAIT.

4.7 Example Loader Application

An example loader application is listed below.

(A) Start the JOB66573 and host computer. Synchronize communication speeds.

(B) Input “4” at the loader’s main menu to select function 4.

(C) The following message is displayed on the terminal software screen.

Please Download Program to Program RAM

(D) Perform a non-procedural (text) transmission from the terminal software of an Intel HEX format file created using the CC665 C Compiler package.

If the program download is successful, the following is displayed on the terminal software screen.

Downloading Completed
Reset & Change Memory Map to 00 OK? (Y/N)

Inputting a “Y” will automatically start program execution.

If the program download failed, LED3 is lit and the following is displayed on the terminal software screen.

Download Error

In this case, press the reboot switch (SW4), change the communication speed of the terminal software, and repeat this procedure from step A).

(E) If desired to download another application, press the reboot switch (SW4) and repeat this procedure from step A).

(F) To quit, press the power switch of the JOB66573 to cutoff power and then quit the terminal.

