

SUNSTAR商斯达实业集团是集研发、生产、工程、销售、代理经销、技术咨询、信息服务等为一体的高科技企业，是专业高科技电子产品生产厂家，是具有 10 多年历史的专业电子元器件供应商，是中国最早和最大的仓储式连锁规模经营大型综合电子零部件代理分销商之一，是一家专业代理和分销世界各大品牌IC芯片和电子元器件的连锁经营综合性国际公司。在香港、北京、深圳、上海、西安、成都等全国主要电子市场设有直属分公司和产品展示展销窗口门市部专卖店及代理分销商，已在全国范围内建成强大统一的供货和代理分销网络。我们专业代理经销、开发生产电子元器件、集成电路、传感器、微波光电元器件、工控机/DOC/DOM电子盘、专用电路、单片机开发、MCU/DSP/ARM/FPGA软件硬件、二极管、三极管、模块等，是您可靠的一站式现货配套供应商、方案提供商、部件功能模块开发配套商。专业以现代信息产业（计算机、通讯及传感器）三大支柱之一的传感器为主营业务，专业经营各类传感器的代理、销售生产、网络信息、科技图书资料及配套产品设计、工程开发。我们的专业网站——**中国传感器科技信息网（全球传感器数据库）www.SENSOR-IC.COM** 服务于全球高科技生产商及贸易商，为企业科技产品开发提供技术交流平台。欢迎各厂商互通有无、交换信息、交换链接、发布寻求代理信息。欢迎国外高科技传感器、变送器、执行器、自动控制产品厂商介绍产品到 中国，共同开拓市场。本网站是关于各种传感器-变送器-仪器仪表及工业自动化大型专业网站，深入到工业控制、系统工程计 测量、自动化、安防报警、消费电子等众多领域，把最新的传感器-变送器-仪器仪表买卖信息，最新技术供求，最新采购商，行业动态，发展方向，最新的技术应用和市场资讯及时的传递给广大科技开发、科学研究、产品设计人员。本网站已成功为石油、化工、电力、医药、生物、航空、航天、国防、能源、冶金、电子、工业、农业、交通、汽车、矿山、煤炭、纺织、信息、通信、IT、安防、环保、印刷、科研、气象、仪器仪表等领域从事科学研究、产品设计、开发、生产制造的科技人员、管理人员、和采购人员提供满意服务。 **我公司专业生产、代理、经销、销售各种传感器、变送器、敏感元器件、开关、执行器、仪器仪表、自动化控制系统：** 专业从事设计、生产、销售各种传感器、变送器、各种测控仪表、热工仪表、现场控制器、计算机控制系统、数据采集系统、各类环境监控系统、专用控制系统应用软件以及嵌入式系统开发及应用等工作。如热敏电阻、压敏电阻、温度传感器、温度变送器、湿度传感器、湿度变送器、气体传感器、气体变送器、压力传感器、压力变送、称重传感器、物（液）位传感器、物（液）位变送器、流量传感器、流量变送器、电流（压）传感器、溶氧传感器、霍尔传感器、图像传感器、超声波传感器、位移传感器、速度传感器、加速度传感器、扭距传感器、红外传感器、紫外传感器、火焰传感器、激光传感器、振动传感器、轴角传感器、光电传感器、接近传感器、干簧管传感器、继电器传感器、微型电泵、磁敏（阻）传感器、压力开关、接近开关、光电开关、色标传感器、光纤传感器、齿轮测速传感器、时间继电器、计数器、计米器、温控仪、固态继电器、调压模块、电磁铁、电压表、电流表等特殊传感器。同时承接传感器应用电路、产品设计和自动化工程项目。

欢迎索取免费详细资料、设计指南和光盘；产品凡多，未能尽录，欢迎来电查询。

更多产品请看本公司产品专用销售网站：

商斯达中国传感器科技信息网：<http://www.sensor-ic.com/>

商斯达工控安防网：<http://www.pc-ps.net/>

商斯达电子元器件网：<http://www.sunstare.com/>

商斯达微波光电产品网：[HTTP://www.rfoe.net/](http://www.rfoe.net/)

商斯达消费电子产品网：<http://www.icasic.com/>

商斯达军工产品网：<http://www.junpinic.com/>

商斯达实业科技产品网：<http://www.sunstars.cn/>传感器销售热线：

地址：深圳市福田区福华路福庆街鸿图大厦 1602 室

电话：0755-83607652 83376489 83376549 83370250 83370251 82500323

传真：0755-83376182 (0) 13902971329 MSN: SUNS888@hotmail.com

邮编：518033 E-mail: szss20@163.com QQ: 195847376

深圳赛格展销部：深圳华强北路赛格电子市场 2583 号 电话：0755-83665529

技术支持：0755-83394033 13501568376

Bluetooth is a trademark owned by Bluetooth SIG, Inc., U.S.A.

- **The information in this document is current as of October, 2002. The information is subject to change without notice. For actual design-in, refer to the latest publications of NEC's data sheets or data books, etc., for the most up-to-date specifications of NEC semiconductor products. Not all products and/or types are available in every country. Please check with an NEC sales representative for availability and additional information.**
 - No part of this document may be copied or reproduced in any form or by any means without prior written consent of NEC. NEC assumes no responsibility for any errors that may appear in this document.
 - NEC does not assume any liability for infringement of patents, copyrights or other intellectual property rights of third parties by or arising from the use of NEC semiconductor products listed in this document or any other liability arising from the use of such products. No license, express, implied or otherwise, is granted under any patents, copyrights or other intellectual property rights of NEC or others.
 - Descriptions of circuits, software and other related information in this document are provided for illustrative purposes in semiconductor product operation and application examples. The incorporation of these circuits, software and information in the design of customer's equipment shall be done under the full responsibility of customer. NEC assumes no responsibility for any losses incurred by customers or third parties arising from the use of these circuits, software and information.
 - While NEC endeavours to enhance the quality, reliability and safety of NEC semiconductor products, customers agree and acknowledge that the possibility of defects thereof cannot be eliminated entirely. To minimize risks of damage to property or injury (including death) to persons arising from defects in NEC semiconductor products, customers must incorporate sufficient safety measures in their design, such as redundancy, fire-containment, and anti-failure features.
 - NEC semiconductor products are classified into the following three quality grades:
"Standard", "Special" and "Specific". The "Specific" quality grade applies only to semiconductor products developed based on a customer-designated "quality assurance program" for a specific application. The recommended applications of a semiconductor product depend on its quality grade, as indicated below. Customers must check the quality grade of each semiconductor product before using it in a particular application.
"Standard": Computers, office equipment, communications equipment, test and measurement equipment, audio and visual equipment, home electronic appliances, machine tools, personal electronic equipment and industrial robots
"Special": Transportation equipment (automobiles, trains, ships, etc.), traffic control systems, anti-disaster systems, anti-crime systems, safety equipment and medical equipment (not specifically designed for life support)
"Specific": Aircraft, aerospace equipment, submersible repeaters, nuclear reactor control systems, life support systems and medical equipment for life support, etc.
- The quality grade of NEC semiconductor products is "Standard" unless otherwise expressly specified in NEC's data sheets or data books, etc. If customers wish to use NEC semiconductor products in applications not intended by NEC, they must contact an NEC sales representative in advance to determine NEC's willingness to support a given application.
- (Note)
- (1) "NEC" as used in this statement means NEC Corporation, NEC Compound Semiconductor Devices, Ltd. and also includes its majority-owned subsidiaries.
 - (2) "NEC semiconductor products" means any semiconductor product developed or manufactured by or for NEC (as defined above).

M8E 00.4-0110

CONTENS

1. INTRODUCTION	5
2. PRODUCTS LINE-UP	6
Discretes.....	6
ICs	6
3. HIGH-FREQUENCY CHARACTERISTICS MAP.....	7
Bipolar Transistors	7
Dual Gate FETs	8
Medium Output Power Transistors, Middle-Power LD-MOS FETs, High-Power LD-MOS FETs	9
Prescalers.....	10
High-Frequency Amplifiers	11
3 V High-Frequency Amplifiers.....	14
4. PACKAGE, CHARACTERISTICS CROSS-REFERENCE.....	15
Low Noise Transistors, SiGe HBT	15
Dual Gate MOS FETs	16
Dual Gate GaAs FETs	16
Twin Transistors	17
5. PART NO., PRODUCTS LINE-UP	18
Low Noise Transistors	18
SiGe HBT	28
Medium Output Power Transistors	28
Middle-Power LD-MOS FETs.....	28
High-Power LD-MOS FETs	30
Dual Gate MOS FETs	30
Dual Gate GaAs FETs	30
Twin Transistors	32
Prescalers.....	36
High-Frequency Amplifiers	38
Down-Converters	42
Up-Converters	46
Differential Input/Output Amplifiers	46
Modulators/Demodulators	48
Variable Gain Amplifiers	48
Low Current High-Frequency Amplifiers	49
BiCMOS, CMOS PLL Synthesizers	49
Bipolar PLL Synthesizers.....	49
6. PACKAGE DIMENSIONS	50
7. MOUNTING PAD LAYOUT	54
8. MARKING, h_{FE} RANK INFORMATION FOR MINIMOLD DEVICES.....	57

Bipolar Transistors	57
SiGe HBT	59
Dual Gate FETs	59
Middle-Power LD-MOS FETs (79A Package)	59
9. MARKINGS VS. PART NO. ON HIGH-FREQUENCY IC OF 4-PIN/6-PIN/SUPER MINIMOLD	60

1. INTRODUCTION

High-frequency semiconductor application, which has conventionally hand-held telephone or CATV/DBS converter, is recently spread over the systems of GPS, Bluetooth™, Wireless LAN and so on.

In order to respond to various needs, NEC Compound Semiconductor Devices, Ltd. prepares rich line-up of high-frequency semiconductors, for example transistors, wideband amplifiers, Up/down-converters, PLL synthesizers etc.

This selection guide introduces our high-frequency semiconductors line-up to select the most suitable products on system design.

We hope this guide helps selecting products among our line-up. On the other hand, to know detail specification, please refer to the latest data sheets, technical notes (application notes) and “**RF and Microwave Devices Data Book (CD-ROM)**” (**PX10017E**) which are helpful as same as this guide. (“**GaAs Device Selection Guide**” (**PG10195E**) is also available.)

2. PRODUCTS LINE-UP

NEC Compound Semiconductor Devices, Ltd. provides two kinds of silicon microwave semiconductors: discrete semiconductors and monolithic ICs of silicon and silicon germanium.

The discrete microwave transistor series can be broadly divided into single type and twin type. The former includes low noise NPN transistors, SiGe HBT, medium output power transistors, middle-power LD-MOS FETs, high-power LD-MOS FETs, dual gate MOS FETs, dual gate GaAs FETs, and so on, whereas the latter consists of twin transistors, which comprise two low-noise NPN transistors integrated in a single package.

The silicon microwave monolithic IC group is made up of transistor arrays and prescalers, amplifiers, mixers, modulators/demodulators, and PLL synthesizer ICs.

The product lineup is illustrated in tree-diagram form below.

(1) Discretes

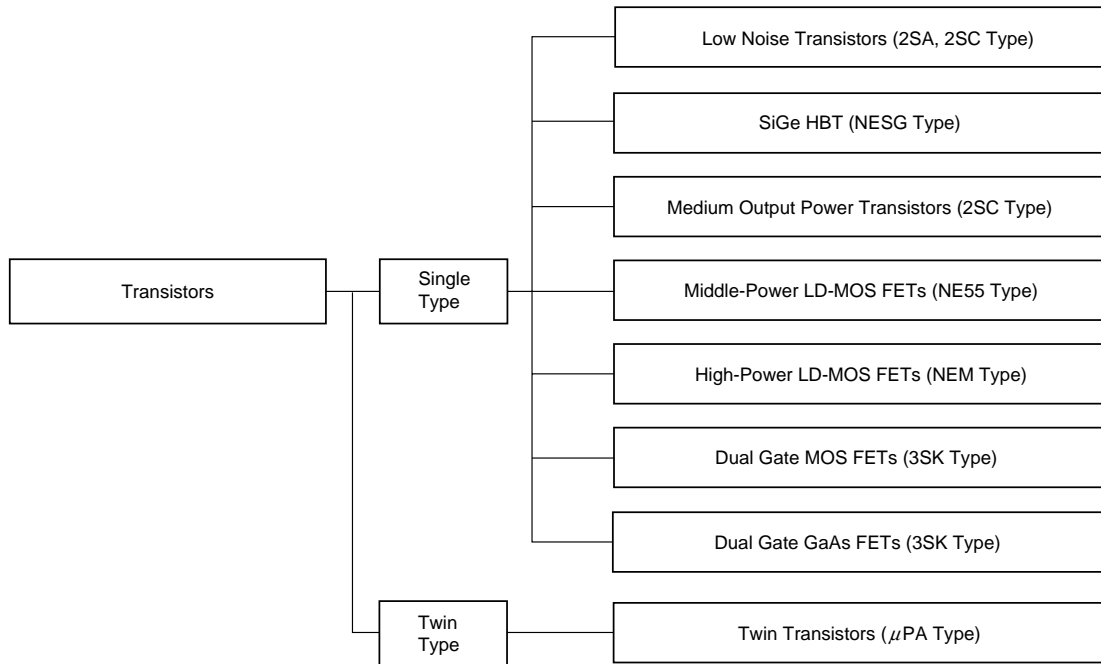

(2) ICs

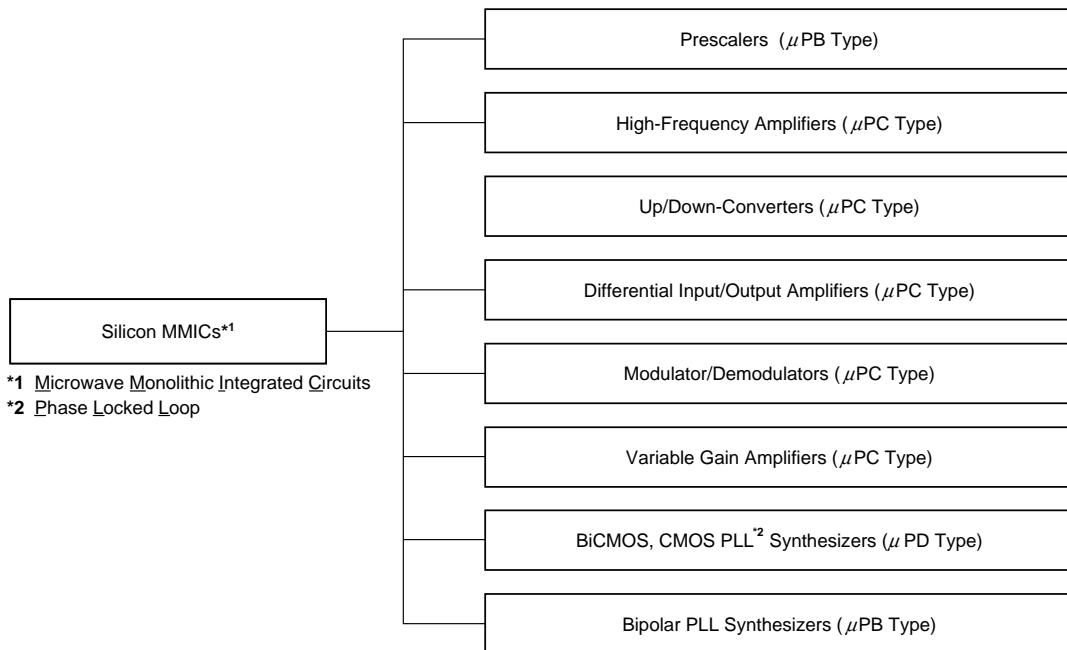

3. HIGH-FREQUENCY CHARACTERISTICS MAP

Bipolar Transistors

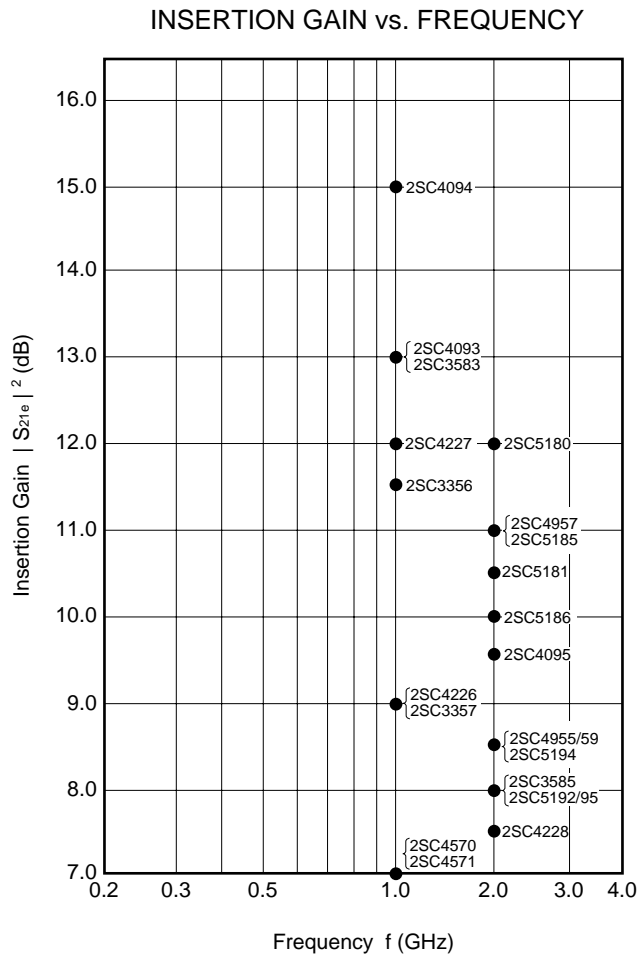

Dual Gate FETs

NOISE FIGURE vs. POWER GAIN (1/3)

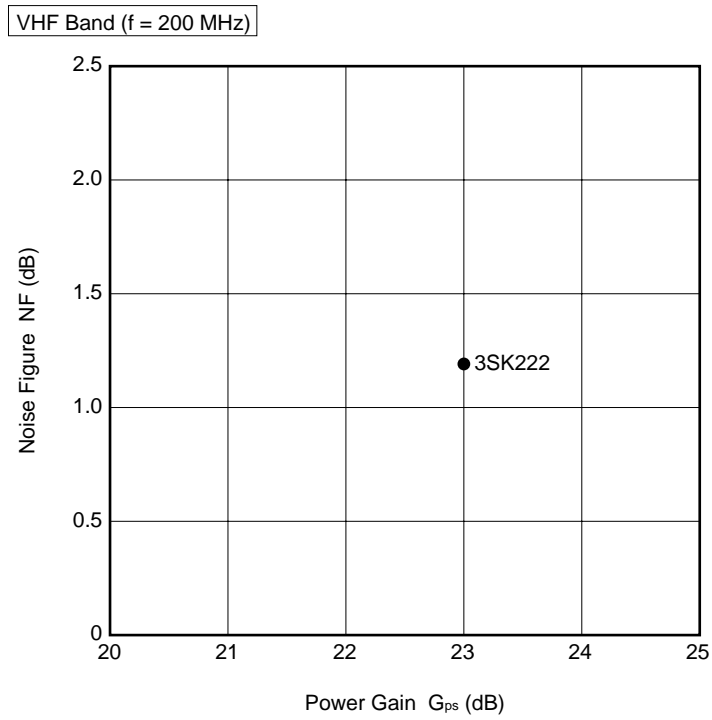

NOISE FIGURE vs. POWER GAIN (2/3)

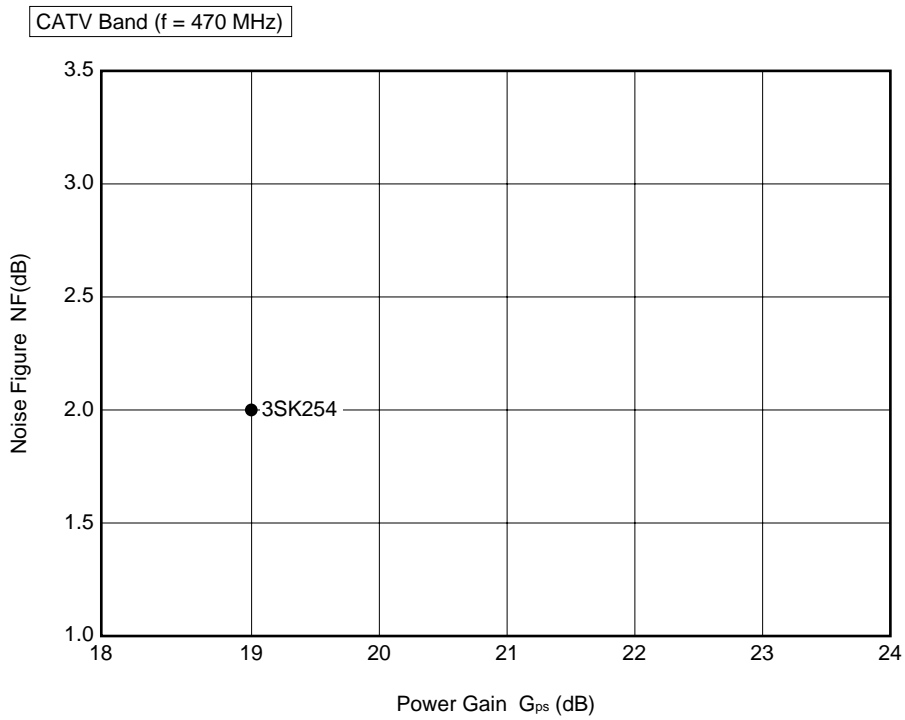

NOISE FIGURE vs. POWER GAIN (3/3)

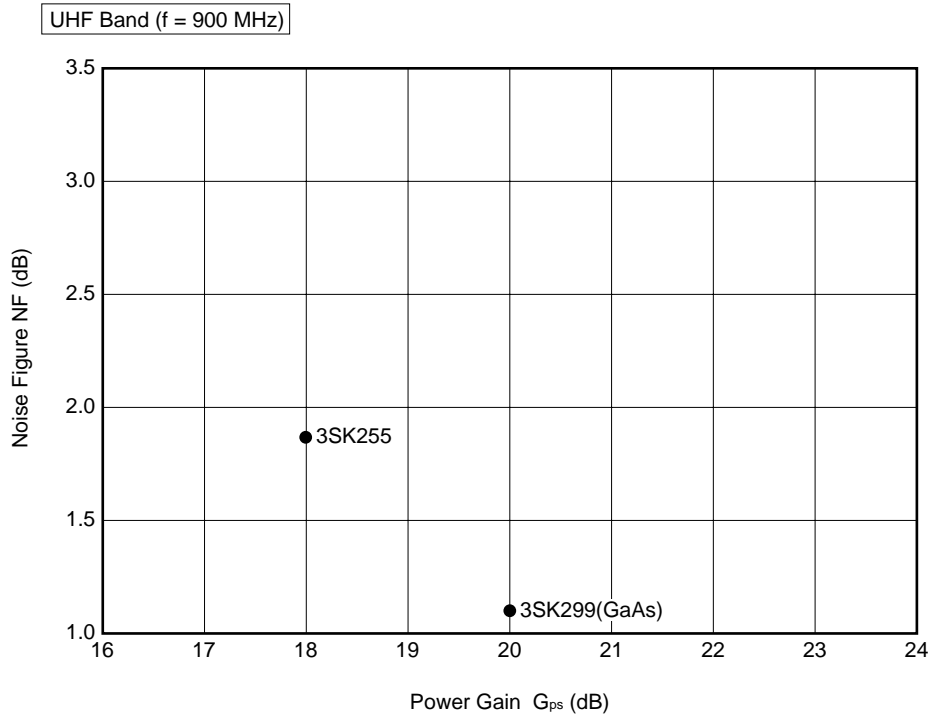

Medium Output Power Transistors, Middle-Power LD-MOS FETs, High-Power LD-MOS FETs

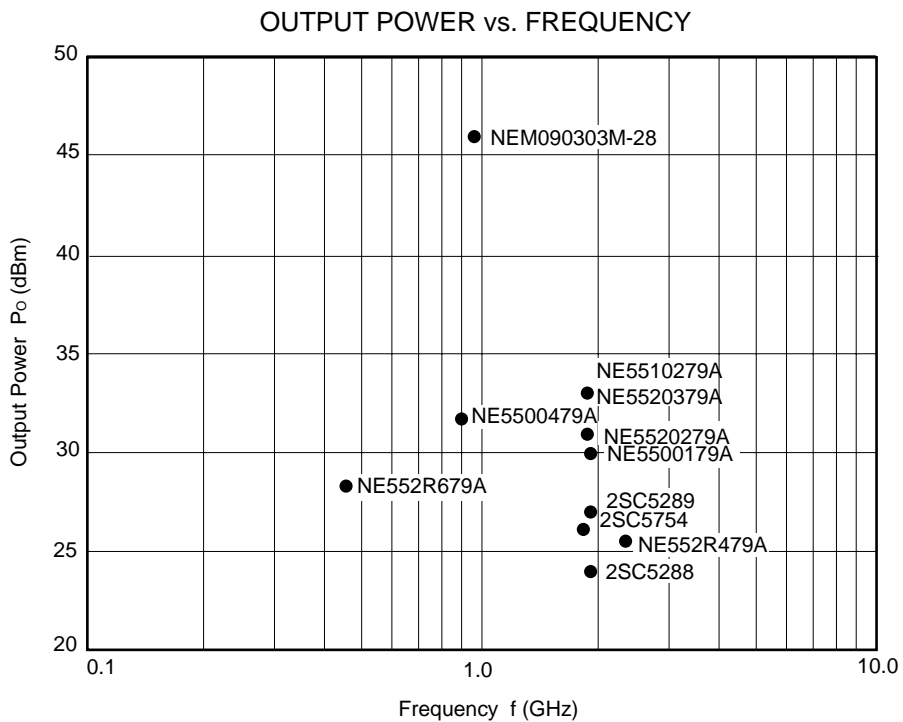

Prescalers

DIVISION RATIO vs. FREQUENCY

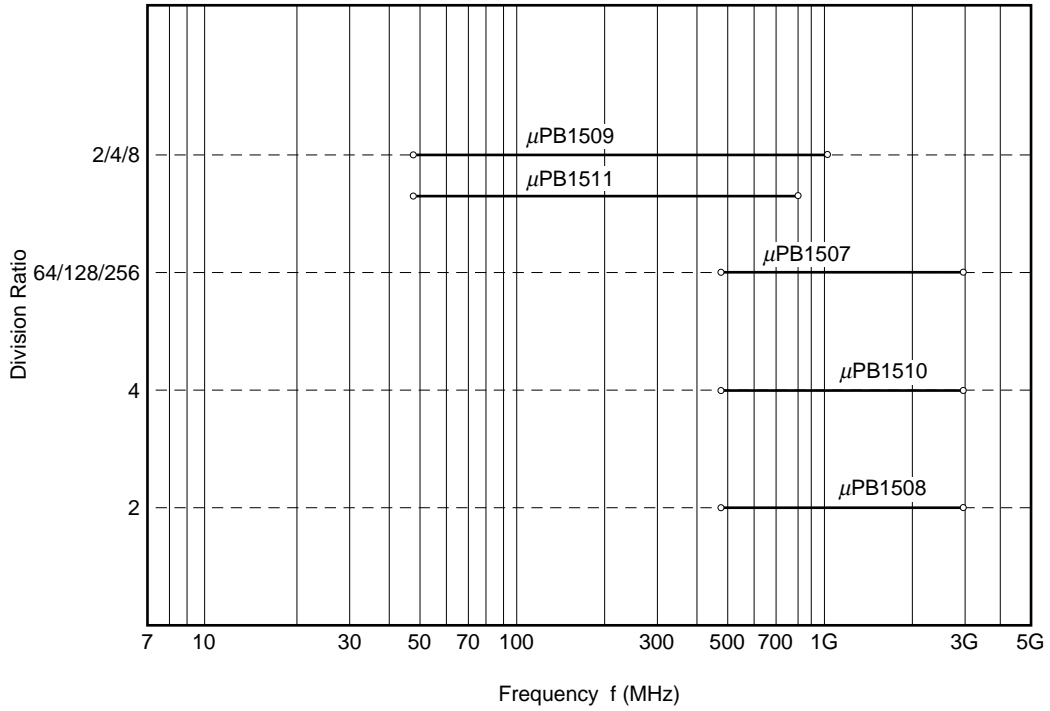

INPUT POWER vs. FREQUENCY

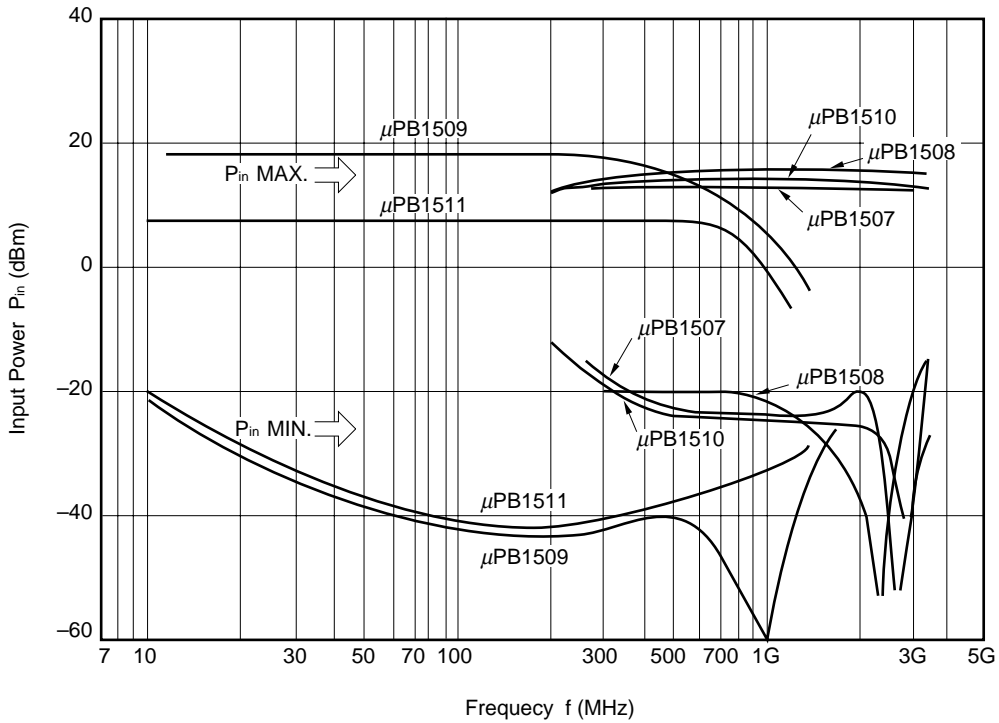

High-Frequency Amplifiers

POWER GAIN, NOISE FIGURE vs. FREQUENCY (1/3)

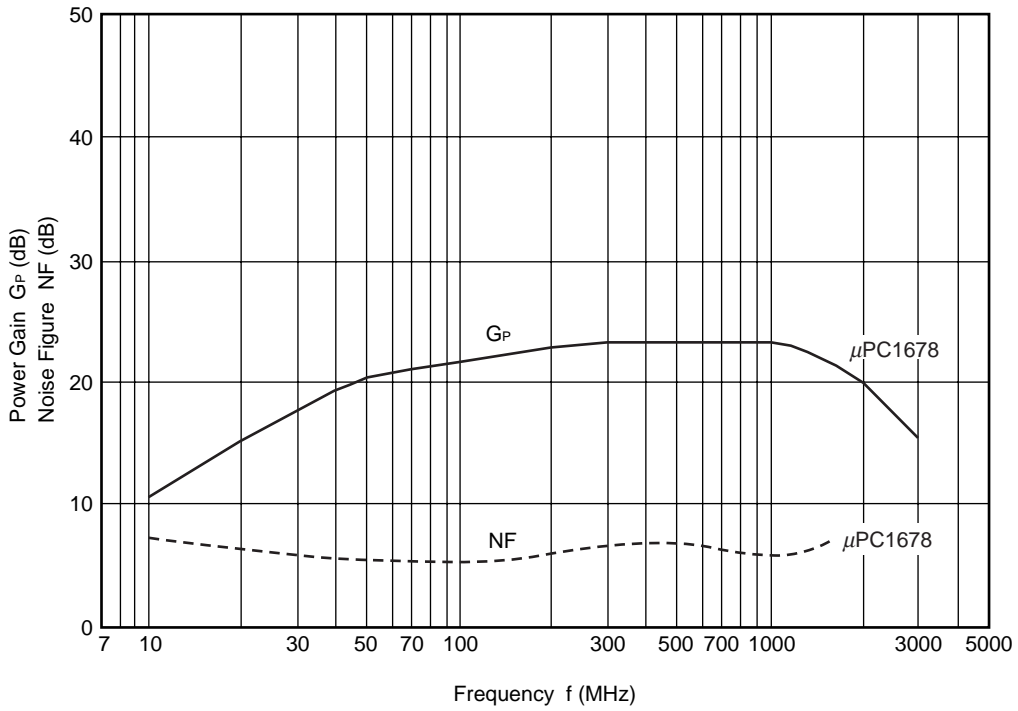

POWER GAIN, NOISE FIGURE vs. FREQUENCY (2/3)

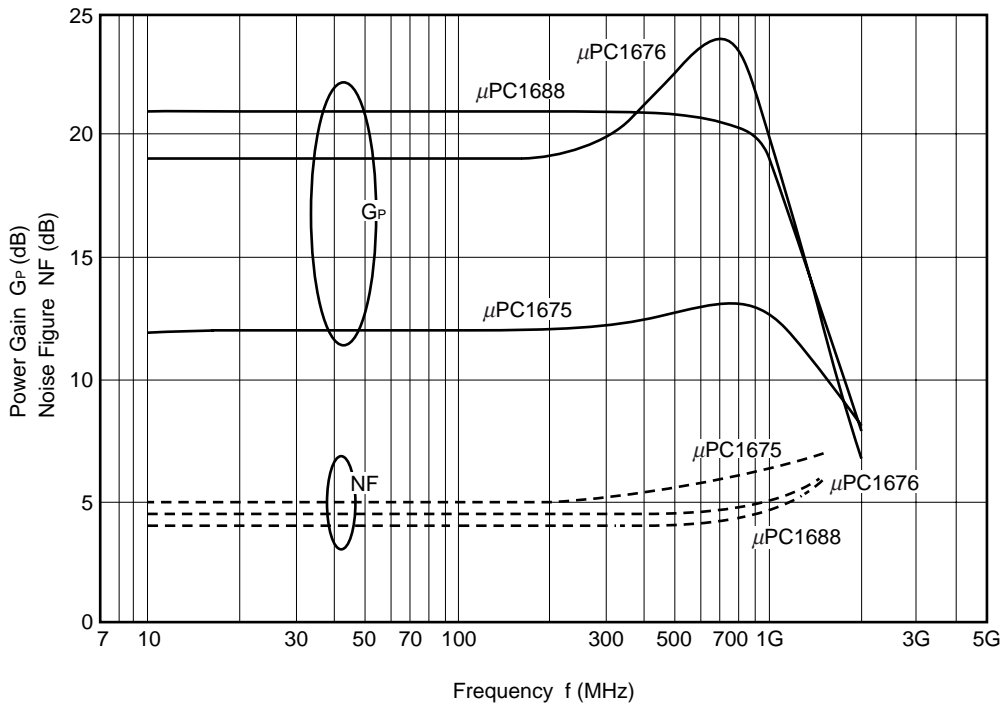

POWER GAIN, NOISE FIGURE vs. FREQUENCY (3/3)

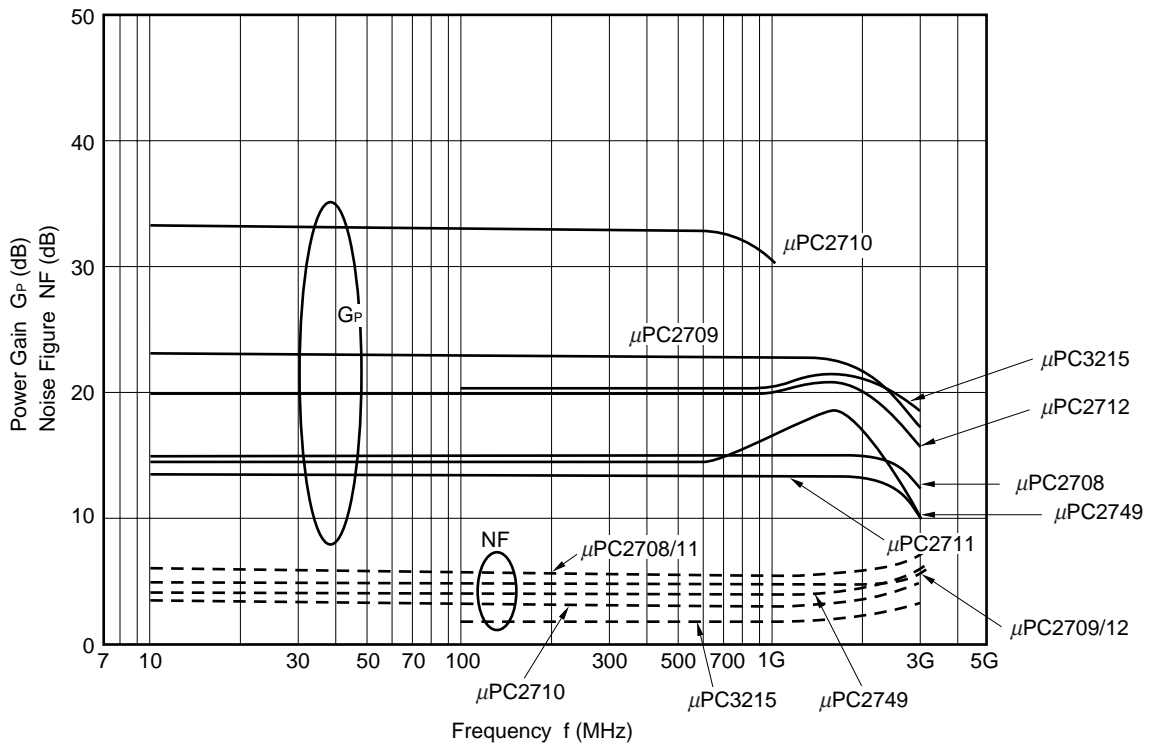

SATURATED OUTPUT POWER vs. FREQUENCY (1/2)

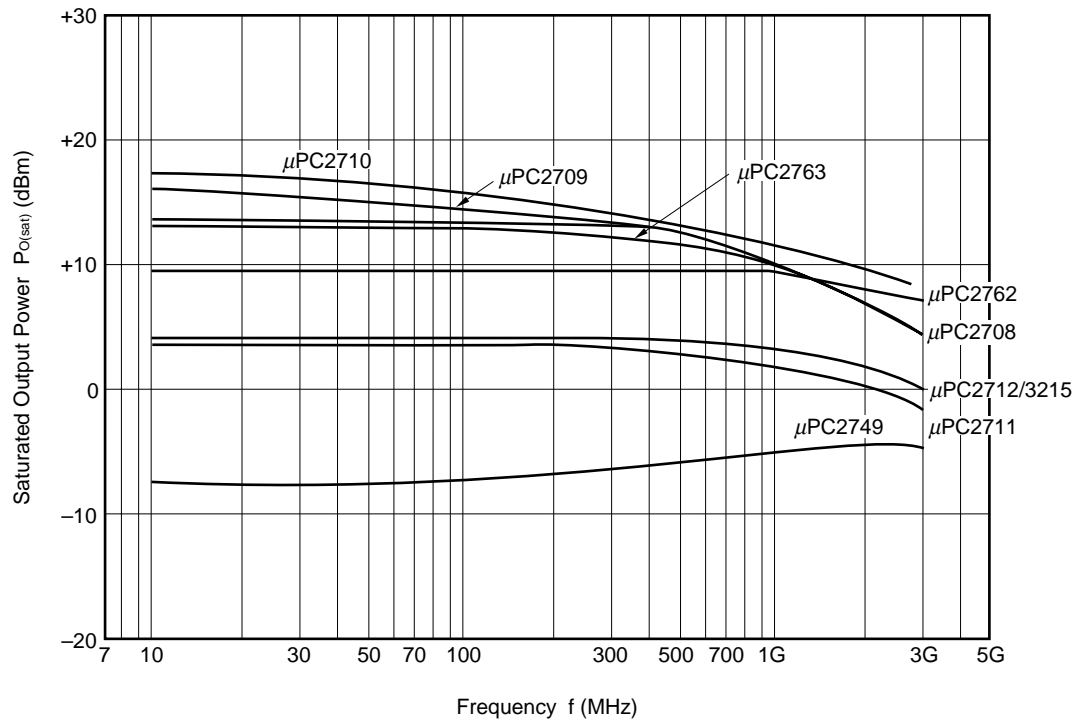

SATURATED OUTPUT POWER vs. FREQUENCY (2/2)

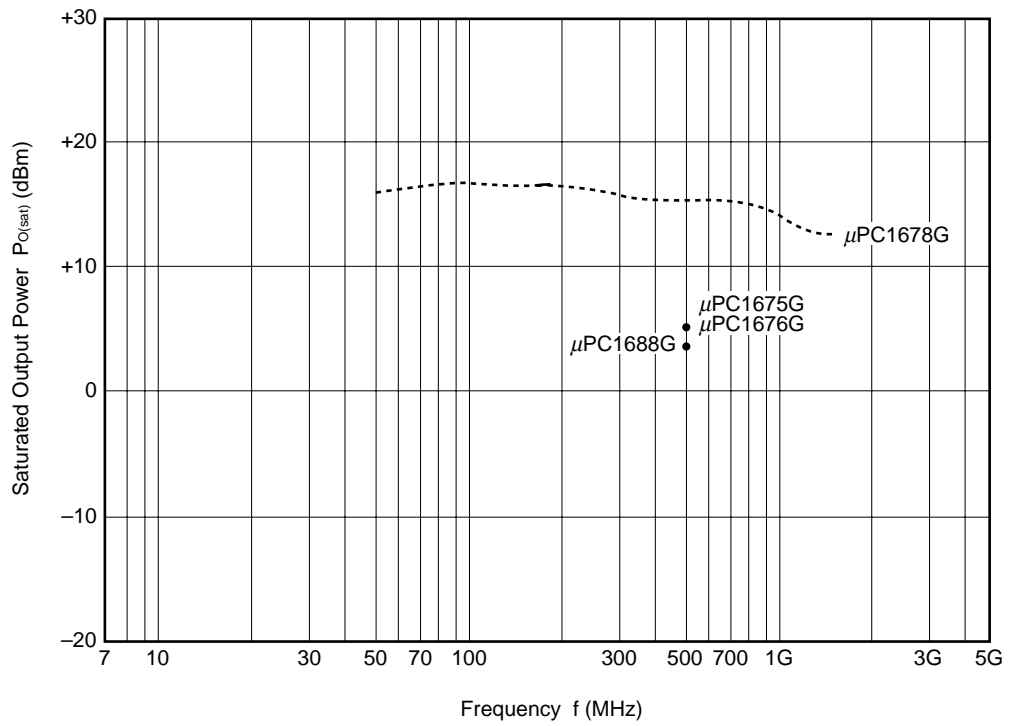

3 V High-Frequency Amplifiers

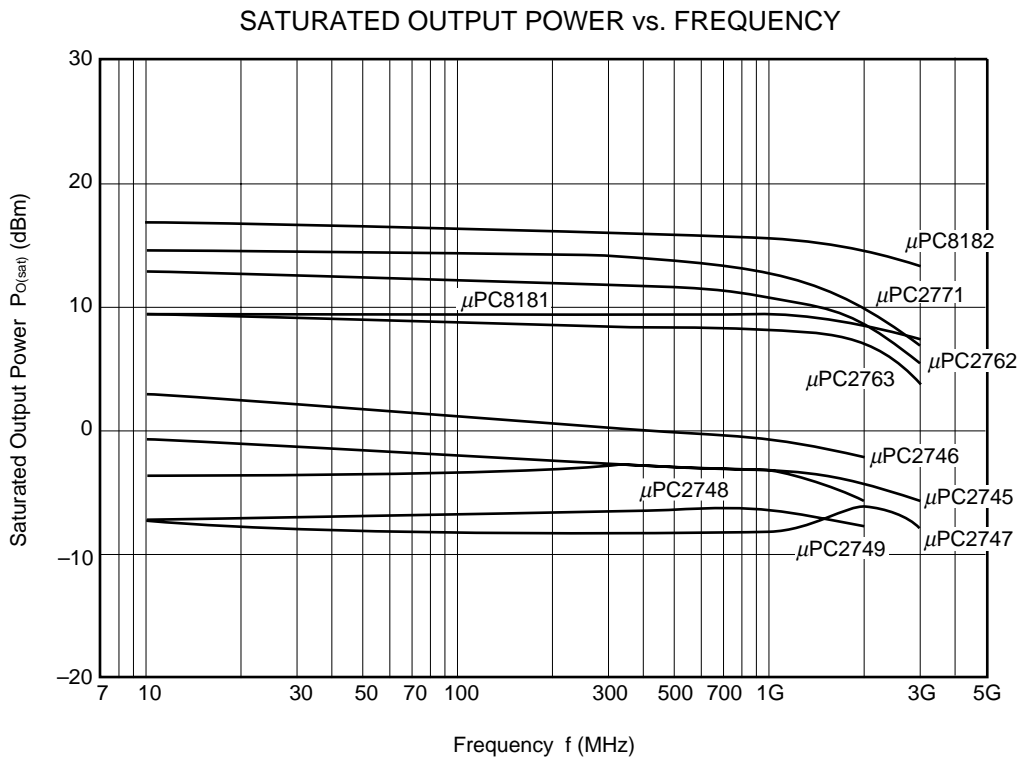
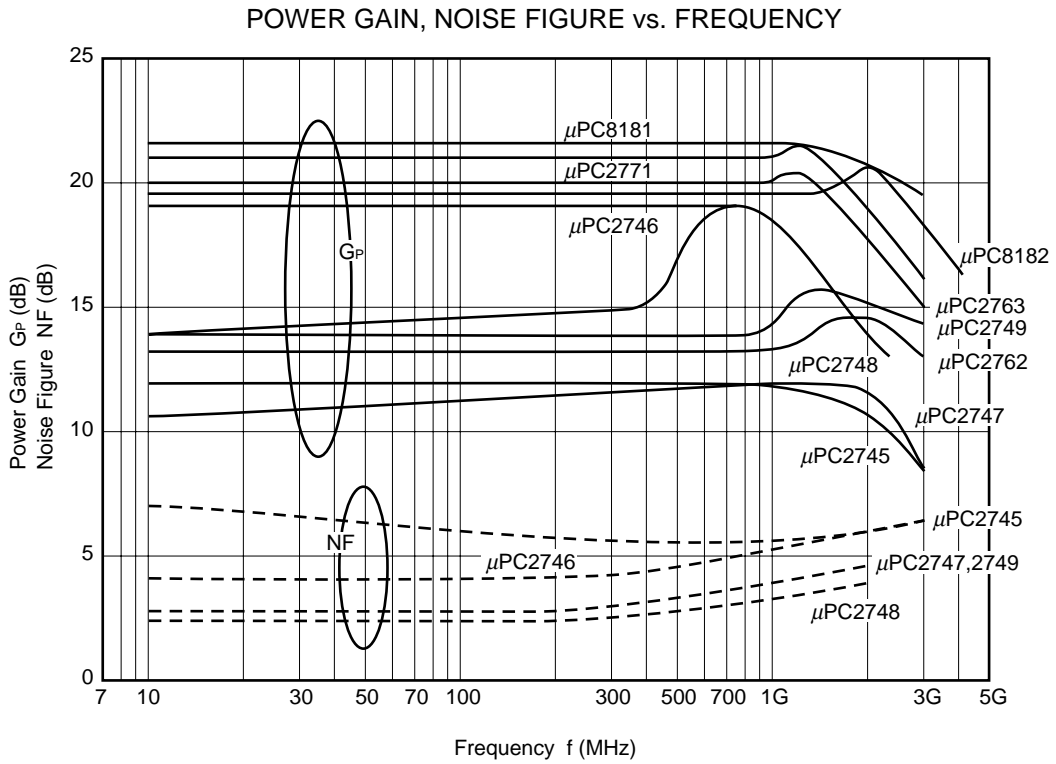

4. PACKAGE, CHARACTERISTICS CROSS-REFERENCE

(1) Low Noise Transistors, SiGe HBT

Transistors Family Table

 New Products

f _r (GHz)	I _c (mA)	2SC No.														Process	
		TO-92	3-Pin Power Minimold (SOT-89) 34	3-Pin Minimold (SOT-23) 33	3-Pin Super Minimold (SOT-323) 30	3-Pin Ultra Super Minimold (1608) 19	Flat-Lead 3-Pin Thin-Type Ultra Super Minimold (1408) M03	3-Pin Lead-Less Minimold (1005) M13	3-Pin Super Lead-Less Minimold (0804) M13	4-Pin Power Minimold (SOT-89) M02	4-Pin Minimold (SOT-143) 39	4-Pin Super Minimold (SOT-343) 18	Flat-Lead 4-Pin Thin-Type Ultra Super Minimold M04	Flat-Lead 4-Pin Thin-Type Ultra Super Minimold M05	6-Pin Super Minimold (SOT-363) M01		6-Pin Lead-Less Minimold (1208)
Mold Size			4.5×2.5	2.9×1.5	2.0×1.25	1.6×0.8	1.4×0.8	1.0×0.5	0.8×0.4	4.5×2.45	2.9×1.5	2.0×1.25	2.0×1.25	2.0×1.25	2.0×1.25	1.2×0.8	Silicon
Package Size			4.5×4.0	2.9×2.8	2.0×2.1	1.6×1.6	1.4×1.2	1.0×0.7	0.8×0.6	4.5×3.95	2.9×2.8	2.0×2.1	2.0×2.05	2.0×2.05	2.0×2.1	1.2×1.0	
High			1.5	1.3	0.9	0.75	0.59	0.5	0.4	1.5	1.3	0.9	0.59	0.59	0.9	0.5	
4.5	70	2570A															
5.0	60				4571	5004	5431										
5.3	250		4536							5337							
5.5	30				4570	5005											
6.0	150		4703							5338							
7.0	100*1	3355	3357	3356	4226	5006	5432	5614		5336	4093	5011					
								5676	5677								
								5745	5746								
9.0	65	3582		3583	4227	5007	5433	5615			4094	5012					
10.0	35			3585	4228	5008	5434				4095	5013					
	100*1			5191	5193	5195	5437				5192	5194					
						5741	5736										
	150						5800	5801	NE851M33				5288				
300												5289					
12.0	30			4955	4959	5010	5435	5617	NE685M33		4957	5015					
	100										5455	5752	5753				
14.0	30														5369		
14.5	50										5454						
15.0	50												5750	5751			
	10					5181							5180				
15.5	30					5186	5436	5618	NE687M33				5185				
	100													5509			
20.0	35						5786	5787									
	500												5754				
21.0	35					5667	5668	5674									
25.0	12												5507				
	35					5606	NE662M03						5508			5704	
25.0	35													NE62021M05	NE62031M05		SiGe
	100													NE62101M05			
36.0	35												5761			5843	

*1 The lower-line product is an improved-characteristics version.

(2) Dual Gate MOS FETs

Application		Package	4 -pin Minimold	4-pin Super Minimold
VHF Band (to 200 MHz)			3SK222	
CATV Band (to 470 MHz)				3SK254
UHF Band (to 900 MHz)	$\lambda/4$ matching			3SK255

(3) Dual Gate GaAs FETs

Package	Remark
4-pin Super Minimold	
3SK299	$W_g = 400 \mu\text{m}$

(4) Twin Transistors

Twin transistors are composed of two low-noise NPN transistors integrated in a single package, and can be divided into 4 different types, depending on the pin layout. There are, moreover, 2 types of chip: a homogenous chip on which two elements with identical characteristics have been mounted ("same chip"), and a heterogeneous chip on which two elements with different characteristics have been mounted ("different chip"). Various package sizes are also available. The relationship between the part number and internal elements is shown in the table below.

 New Products

Type 1		Type 2		Type 3		Type 4		
Same Chip				Different Chip				
for Pager		for VCO		for Mobile Communications		for VCO		
Part No.	2SC No. (×2)	Part No.	2SC No. (×2)	Part No.	2SC No. (×2)	2SC No.		
						Q1	Q2	
μPA800T	2SC5434	μPA811T	2SC5434			μPA831TC	2SC5432	2SC5433
μPA801T, TC	2SC5432	μPA810T	2SC5432			μPA841TD	2SC5435	2SC5600
μPA802T, TC	2SC5433	μPA812T	2SC5433			μPA844TC	2SC5436	2SC5668
μPA803T	2SC5005	μPA813T	2SC5005			μPA850TD	2SC5435	2SC5736
μPA804T	2SC5431					μPA851TD	2SC5737	2SC5736
μPA805T	2SC5009					μPA854TD	2SC5435	2SC5745
μPA806T	2SC5435					μPA855TD	2SC5737	2SC5745
μPA807T	2SC5181					μPA859TD	2SC5737	2SC5676
μPA808T, TC	2SC5436			μPA828TC	2SC5436	μPA860TC, TD	2SC5435	2SC5786
μPA809T	2SC5437	μPA814T	2SC5437	μPA891TC, TD	2SC5600	μPA861TC, TD	2SC5436	2SC5786
μPA872TD	2SC5676			μPA892TC, TD	2SC5668	μPA862TC, TD, TS	2SC5435	2SC5800
μPA873TC, TD, TS	2SC5800			μPA895TD, TS	2SC5800	μPA863TC, TD, TS	2SC5436	2SC5800

Remark Mold size

- T Type : 2.0 × 1.25 × 0.9 (mm)
- TC Type : 1.5 × 1.1 × 0.55 (mm)
- TD Type : 1.2 × 0.8 × 0.5 (mm)
- TS Type : 1.0 × 0.7 × 0.5 (mm)

5. PART NO., PRODUCTS LINE-UP

(1) Low Noise Transistors (1/5)

A wide range of products are available, classified by function and application.

Part Number	Absolute Maximum Ratings (T _A = +25°C)				Electrical Characteristics (T _A = +25°C)													
	V _{CB0} (V)	V _{CEO} (V)	V _{EBO} (V)	P _T (mW)	h _{FE}				f _t (GHz)			C _{re} (pF)					S _{21e} ² (dB)	
					V _{CE} (V)	I _C (mA)	MIN.	MAX.	V _{CE} (V)	I _C (mA)	TYP.	V _{CB} (V)	I _E (mA)	f (MHz)	TYP.	MAX.	V _{CE} (V)	I _C (mA)
2SA1977 (NE97733)	-20	-12	-3	200	-8	-20	20	100	-8	-20	8.5	-10	0	1	0.5	1	-8	-20
2SA1978 (NE97833)	-20	-12	-3	200	-10	-15	20	100	-10	0	0.5	-10	0	1	0.5	1	-10	-15
2SC2570A (NE02132)	25	12	3	600	10	20	40	200	10	20	5.0	10	0	1	0.7	1.0	10	20
2SC3355 (NE85632)	20	12	3	600	10	20	50	300	10	20	6.5	10	0	1	0.65	1.0	10	20
2SC3356 (NE85633)	20	12	3	200	10	20	50	300	10	20	7.0	10	0	1	0.55	1.0	10	20
2SC3357 (NE85634)	20	12	3	1 200	10	20	50	300	10	20	6.5	10	0	1	0.65	1.0	10	20
2SC3582 (NE68132)	20	10	1.5	600	8	20	50	250	8	20	8.0	10	0	1	0.4	0.9	8	20
2SC3583 (NE68133)	20	10	1.5	200	8	20	50	250	8	20	9.0	10	0	1	0.35	0.9	8	20
2SC3585 (NE68033)	20	10	1.5	200	6	10	50	250	6	10	10.0	10	0	1	0.3	0.8	6	10
2SC4093 (NE85639E)	20	12	3	200	10	20	50	250	10	20	6.5	10	0	1	0.5	0.9	10	20
2SC4094 (NE68139)	20	10	1.5	200	8	20	50	250	8	20	9.0	10	0	1	0.25	0.8	8	20
2SC4095 (NE68039E)	20	10	1.5	200	6	10	50	250	6	10	10.0	10	0	1	0.25	0.8	6	10
2SC4226 (NE85630)	20	12	3.0	150	3	7	40	250	3	7	4.5	3	0	1	0.7	1.5	3	7
2SC4227 (NE68130)	20	10	1.5	150	3	7	40	240	3	7	7.0	3	0	1	0.45	0.9	3	7
2SC4228 (NE68030)	20	10	1.5	150	3	5	50	250	3	5	8.5	3	0	1	0.3	0.7	3	5
2SC4536 (NE46134)	30	15	3.0	2 000	10	50	40	200	10	50	5.7	10	0	1	2.2	-	10	50
2SC4570 (NE58130)	20	12	3.0	200	5	5	40	200	5	5	5.5	5	0	1	0.7 ^{*1}	0.9 ^{*1}	5	5
2SC4571 (NE58230)	20	12	3.0	200	5	5	40	200	5	5	5.0	5	0	1	0.9 ^{*1}	1.2 ^{*1}	5	5
2SC4703 (NE46234)	25	12	2.5	1 800	5	50	50	250	5	50	6.0	5	0	1	1.5 ^{*1}	2.5 ^{*1}	5	50

*1 C_{ob} (measurement: emitter open)

Electrical Characteristics (T _A = +25°C)								Marking (h _{FE} value)	Outline	Part Number
S _{21e} ² (dB)		NF (dB)					Remarks			
f (GHz)	TYP.	V _{CE} (V)	I _c (mA)	f (GHz)	TYP.	MAX.				
1	12	-8	-3	1	1.5	3			T92	3MM
1	10	-10	-3	1	2	3		T93	3MM	2SA1978 (NE97833)
1.0	10.0	10	5	1.0	1.5	3.0	MAG = 11.5 dB (TYP.), @ f = 1 GHz	E	TO-92	2SC2570A (NE02132)
1.0	9.5	10	7	1.0	1.1	-	NF = 1.8 dB(TYP.), @ I _c = 40 mA, f = 1 GHz	K	TO-92	2SC3355 (NE85632)
1.0	11.5	10	7	1.0	1.1	2.0		R23, R24, R25	3MM	2SC3356 (NE85633)
1.0	9.0	10	7	1.0	1.1	-	NF = 1.8 dB(TYP.), @ I _c = 40 mA, f = 1 GHz	RH, RF, RE	3PMM	2SC3357 (NE85634)
1.0	11.0	8	7	1.0	1.2	2.5	MAG = 13 dB (TYP.), @ f = 1.0 GHz	K	TO-92	2SC3582 (NE68132)
1.0	13.0	8	7	1.0	1.2	2.5	MAG = 15 dB (TYP.), @ f = 1.0 GHz	R33, R34, R35	3MM	2SC3583 (NE68133)
2.0	8.0	6	5	2.0	1.8	3.0	MAG = 10 dB (TYP.), @ f = 2.0 GHz	R43, R44, R45	3MM	2SC3585 (NE68033)
1.0	13.0	10	7	1.0	1.1	2.0		R26, R27, R28	4MM	2SC4093 (NE85639E)
1.0	15.0	8	7	1.0	1.2	2.5	MAG = 17.0 dB (TYP.), @ f = 1.0 GHz	R36, R37, R38	4MM	2SC4094 (NE68139)
2.0	9.5	6	5	2.0	1.8	3.0	MAG = 12.0 dB (TYP.), @ f = 2.0 GHz	R46, R47, R48	4MM	2SC4095 (NE68039E)
1.0	9.0	3	7	1.0	1.2	2.5		R23, R24, R25	3SMM	2SC4226 (NE85630)
1.0	12	3	7	1.0	1.4	2.7		R33, R34, R35	3SMM	2SC4227 (NE68130)
2.0	7.5	3	5	2.0	1.9	3.2		R43, R44, R45	3SMM	2SC4228 (NE68030)
1.0	7.0	10	50	0.5	2.5	-	NF = 1.5 dB (TYP.) @ I _c = 10 mA, f = 500 MHz	QR, QS	3PMM	2SC4536 (NE46134)
1.0	7.0	-	-	-	-	-		T72, T73, T74	3SMM	2SC4570 (NE58130)
1.0	7.0	-	-	-	-	-		T75, T76, T77	3SMM	2SC4571 (NE58230)
1.0	8.3	5	50	1.0	2.3	3.5	IM ₂ = -55 dB, IM ₃ = -76 dB	SH, SF, SE	3PMM	2SC4703 (NE46234)

(1) Low Noise Transistors (2/5)

Part Number	Absolute Maximum Ratings (T _A = +25°C)				Electrical Characteristics (T _A = +25°C)													
	V _{CB0} (V)	V _{CEO} (V)	V _{EBO} (V)	P _T (mW)	h _{FE}				f _r (GHz)			C _{re} (pF)					S _{21e} ² (dB)	
					V _{CE} (V)	I _c (mA)	MIN.	MAX.	V _{CE} (V)	I _c (mA)	TYP.	V _{CB} (V)	I _E (mA)	f (MHz)	TYP.	MAX.	V _{CE} (V)	I _c (mA)
2SC4955 (NE68533)	9	6	2.0	180	3	10	65	175	3	10	12	3	0	1	0.4	0.7	3	10
2SC4957 (NE68539E)	9	6	2.0	180	3	10	65	175	3	10	12	3	0	1	0.3	0.5	3	10
2SC4959 (NE68530)	9	6	2.0	150	3	10	65	175	3	10	12	3	0	1	0.4	0.7	3	10
2SC5004 (NE58219)	20	12	3.0	100	5	5	60	120	5	5	5.0	5	0	1	0.9 ^{*1}	1.2 ^{*1}	5	5
2SC5005 (NE58119)	20	12	3.0	100	5	5	60	120	5	5	5.5	5	0	1	0.7 ^{*1}	0.9 ^{*1}	5	5
2SC5006 (NE85619)	20	12	3.0	100	3	7	80	160	3	7	4.5	3	0	1	0.7	1.5	3	7
2SC5007 (NE68119)	20	10	1.5	100	3	7	80	160	3	7	7.0	3	0	1	–	0.9	3	7
2SC5008 (NE68019)	20	10	1.5	100	3	5	80	160	3	7	8.0	3	0	1	0.3	0.7	3	5
2SC5010 (NE68519)	9	6	2.0	100	3	10	65	175	3	10	12.0	3	0	1	0.4	0.7	3	3
2SC5011 (NE85618)	20	12	3.0	150	3	7	50	250	10	20	6.5	10	0	1	0.5	0.9	10	20
2SC5012 (NE68118)	20	10	1.5	150	8	20	50	250	8	20	9.0	10	0	1	0.25	0.8	8	20
2SC5013 (NE68018)	20	10	1.5	150	6	10	50	250	6	10	10.0	10	0	1	0.25	0.8	6	10
2SC5015 (NE68518)	9	6	2.0	150	3	10	65	175	3	10	12.0	3	0	1	0.3	0.5	3	10

*1 C_{ob} (measurement: emitter open)

*2 MIN. spec

Electrical Characteristics (T _A = +25°C)								Remarks	Marking (h _{FE} value)	Outline	Part Number
S _{21e} ² (dB)		NF (dB)									
f (GHz)	TYP.	V _{CE} (V)	I _C (mA)	f (GHz)	TYP.	MAX.					
2.0	8.5	3	3	2.0	1.5	2.5		T83	3MM	2SC4955 (NE68533)	
2.0	11	3	3	2.0	1.5	2.5		T83	4MM	2SC4957 (NE68539E)	
2.0	11	3	3	2.0	1.5	2.5		T83	3SMM	2SC4959 (NE68530)	
1.0	5.0 ⁺²	–	–	–	–	–		77	3USMM	2SC5004 (NE58219)	
1.0	5.0 ⁺²	–	–	–	–	–		73	3USMM	2SC5005 (NE58119)	
1.0	9	3	7	1.0	1.2	2.5		24	3USMM	2SC5006 (NE85619)	
1.0	12	3	7	1.0	1.4	2.7		34	3USMM	2SC5007 (NE68119)	
2.0	7.5	3	5	2.0	1.9	3.2		44	3USMM	2SC5008 (NE68019)	
2.0	8.5	3	3	2.0	1.5	2.5		83	3USMM	2SC5010 (NE68519)	
1.0	13	10	7	1.0	1.1	2.0		R26, R27, R28	4SMM	2SC5011 (NE85618)	
1.0	15	8	7	1.0	1.2	2.5		R36, R37, R38	4SMM	2SC5012 (NE68118)	
2.0	9.5	6	5	2.0	1.8	3.0		R46, R47, R48	4SMM	2SC5013 (NE68018)	
2.0	11	3	3	2.0	1.5	2.5		T83	4SMM	2SC5015 (NE68518)	

(1) Low Noise Transistors (3/5)

Part Number	Absolute Maximum Ratings (T _A = +25°C)					Electrical Characteristics (T _A = +25°C)											
	V _{CB0} (V)	V _{CEO} (V)	V _{EBO} (V)	I _c (mA)	P _T (mW)	h _{FE}				f _T (GHz)			C _{re} (pF)				
						V _{CE} (V)	I _c (mA)	MIN.	MAX.	V _{CE} (V)	I _c (mA)	TYP.	V _{CB} (V)	I _E (mA)	f (MHz)	TYP.	MAX.
2SC5180 (NE68618)	5	3	2	10	30	2	7	70	140	2	7	15.5	2	0	1	0.3	0.5
2SC5181 (NE68619)	5	3	2	10	30	2	7	70	140	2	7	13	2	0	1	0.3	0.4
2SC5185 (NE68718)	5	3	2	30	90	2	20	70	140	2	20	13	2	0	1	0.3	0.6
2SC5186 (NE68719)	5	3	2	30	90	2	20	70	140	2	20	11	2	0	1	0.4	0.8
2SC5191 (NE68833)	9	6	2	100	200	1	3	80	160	3	20	8.5	1	0	1	0.75	0.85
2SC5192 (NE68839)	9	6	2	100	200	1	3	80	160	3	20	9	1	0	1	0.65	0.8
2SC5193 (NE68830)	9	6	2	100	150	1	3	80	160	3	20	9	1	0	1	0.75	0.85
2SC5194 (NE68818)	9	6	2	100	150	1	3	80	160	3	20	10	1	0	1	0.65	0.8
2SC5195 (NE68819)	9	6	2	100	125	1	3	80	160	3	20	9.5	1	0	1	0.7	0.8
2SC5336 (NE856M02)	20	12	3	100	1 200	10	20	50	250	10	20	6.5	10	0	1	0.5	0.8
2SC5337 (NE461M02)	30	15	3	250	2 000	10	50	40	200	–	–	–	–	–	–	–	–
2SC5338 (NE462M02)	25	12	2.5	150	1 800	5	50	50	250	5	50	6	5	0	1	1	2
2SC5369 (NE696M01)	9	6	2	30	150	3	10	80	160	3	10	14	3	0	1	0.15	0.25

Electrical Characteristics (T _A = +25°C)										Rank	Marking (h _{FE} value)	Outline	Part Number
S _{21e} ² (dB)				NF					Remarks				
V _{CE} (V)	I _c (mA)	f (GHz)	TYP.	V _{CE} (V)	I _c (mA)	f (GHz)	TYP.	MAX.					
2	7	2	12	1	3	2	1.5	2.0	Spec at Both V _{CE} = 1 V & 3 V	FB	T84	4SMM	2SC5180 (NE68618)
2	7	2	10.5	1	3	2	1.5	2.0	Spec at Both V _{CE} = 1 V & 3 V	FB	84	3USMM	2SC5181 (NE68619)
2	20	2	11	1	3	2	1.3	2.0	Spec at Both V _{CE} = 1 V & 3 V	FB	T86	4SMM	2SC5185 (NE68718)
2	20	2	10	1	3	2	1.3	2.0	Spec at Both V _{CE} = 1 V & 3 V	FB	86	3USMM	2SC5186 (NE68719)
3	20	2	6.5	3	7	2	1.5	–	Spec at Only V _{CE} = 1 V	FB	T88	3MM	2SC5191 (NE68833)
3	20	2	8	3	7	2	1.5	–	Spec at Only V _{CE} = 1 V	FB	T88	4MM	2SC5192 (NE68839)
3	20	2	6.5	3	7	2	1.5	–	Spec at Only V _{CE} = 1 V	FB	T88	3SMM	2SC5193 (NE68830)
3	20	2	8.5	3	7	2	1.5	–	Spec at Only V _{CE} = 1 V	FB	T88	4SMM	2SC5194 (NE68818)
3	20	2	8	3	7	2	1.5	–	Spec at Only V _{CE} = 1 V	FB	88	3USMM	2SC5195 (NE68819)
10	20	1	12	10	7	1	1.1	–		RH, RF, RE	RH, RF, RE	4PMM	2SC5336 (NE856M02)
10	50	1	8.3	10	50	1	2.0	3.5		QQ, QR, QS	QQ, QR, QS	4PMM	2SC5337 (NE461M02)
5	50	1	10	5	50	1	–	3.5		SH, SF, SE	SH, SF, SE	4PMM	2SC5338 (NE462M02)
3	10	2	14	3	3	2	1.3	2.3		FB	T95	6SMM	2SC5369 (NE696M01)

(1) Low Noise Transistors (4/5)

Part Number	Absolute Maximum Ratings (T _A = +25°C)					Electrical Characteristics (T _A = +25°C)											
	V _{CBO} (V)	V _{CEO} (V)	V _{EBO} (V)	I _c (mA)	P _T (mW)	h _{FE}				f _r (GHz)			C _{re} (pF)				
						V _{CE} (V)	I _c (mA)	MIN.	MAX.	V _{CE} (V)	I _c (mA)	TYP.	V _{CB} (V)	I _E (mA)	f (MHz)	TYP.	MAX.
2SC5431 (NE582M03)	20	12	3	60	100	5	5	60	120	5	5	4.3	5	0	1	0.6	1.2
2SC5432 (NE856M03)	20	12	3	100	125	3	7	80	145	3	7	4.5	3	0	1	0.7	1.5
2SC5433 (NE681M03)	20	10	1.5	65	125	3	7	80	145	3	7	7	3	0	1	–	0.9
2SC5434 (NE680M03)	20	10	1.5	35	125	3	5	80	145	3	5	8	3	0	1	0.3	0.7
2SC5435 (NE685M03)	9	6	2	30	125	3	10	75	140	3	10	12	3	0	1	0.4	0.7
2SC5436 (NE687M03)	5	3	2	30	90	2	20	70	130	2	20	14	2	0	1	0.4	0.8
2SC5437 (NE688M03)	9	6	2	100	125	1	3	80	145	3	20	9.5	1	0	1	0.7	0.8
2SC5454 (NE67739)	9	6	2	50	200	3	20	75	150	3	20	14.5	3	0	1	0.3	0.5
2SC5455 (NE67839)	9	6	2	100	200	3	30	75	150	3	30	12	3	0	1	0.5	0.7
2SC5507 (NE661M04)	15	3.3	1.5	12	39	2	2	50	100	3	10	25	2	0	1	0.08	0.12
2SC5508 (NE662M04)	15	3.3	1.5	35	115	2	5	50	100	3	30	25	2	0	1	0.18	0.24
2SC5509 (NE663M04)	15	3.3	1.5	100	190	2	10	50	100	3	90	17	2	0	1	0.5	0.75
2SC5606 (NE66219)	15	3.3	1.5	35	115	2	3	50	100	2	20	21	2	0	1	0.21	0.3
NE662M03	15	3.3	1.5	35	115	2	5	60	100	2	20	21	2	0	1	–	0.3
2SC5614 (NE856M13)	20	12	3	100	140	3	7	80	145	3	7	4.5	3	0	1	0.7	1.5
2SC5615 (NE681M13)	20	10	1.5	65	140	3	7	80	145	3	7	7	3	0	1	–	0.9
2SC5617 (NE685M13)	9	6	2	30	140	3	10	75	140	3	10	12	3	0	1	0.4	0.7
NE685M33	9	6	2	30	–	3	10	75	150	3	10	12 ^{*1}	0.5	0	1	0.4 ^{*1}	0.7
2SC5618 (NE687M13)	5	3	2	30	90	2	20	70	130	2	20	11	2	0	1	0.4	0.8
NE687M33	5	3	2	30	–	1	10	70	140	3	10	12 ^{*1}	0.5	0	1	0.4 ^{*1}	0.8

*1 Preliminary specification

Electrical Characteristics (T _A = +25°C)										Rank	Marking (h _{FE} value)	Outline	Part Number
S _{21e} ² (dB)				NF					Remarks				
V _{CE} (V)	I _c (mA)	f (GHz)	TYP.	V _{CE} (V)	I _c (mA)	f (GHz)	TYP.	MAX.					
5	5	1	5 (MIN.)	–	–	–	–	–		EB, FB	TA, TB	F3TUSMM	2SC5431 (NE582M03)
3	7	1	10	3	7	1	1.4	2.5		EB, FB	TC, TD	F3TUSMM	2SC5432 (NE856M03)
3	7	1	12	3	7	1	1.4	2.7		EB, FB	TE, TF	F3TUSMM	2SC5433 (NE681M03)
3	5	2	7.5	3	5	2	1.9	3.2		EB, FB	TH, TJ	F3TUSMM	2SC5434 (NE680M03)
3	10	2	8.5	3	3	2	1.5	2.5		EB, FB	TK, TL	F3TUSMM	2SC5435 (NE685M03)
2	20	2	10	2	3	2	1.4	2.0		EB, FB	TN, TP	F3TUSMM	2SC5436 (NE687M03)
3	20	2	8	3	7	2	1.7	–		EB, FB	TS, TT	F3TUSMM	2SC5437 (NE688M03)
3	20	2	12	3	5	2	1.5	2.5		FB	R54	4MM	2SC5454 (NE67739)
3	30	2	10	3	7	2	1.5	2.5		FB	R55	4MM	2SC5455 (NE67839)
2	5	2	17	2	2	2	1.1	1.5		FB	T78	F4TSMM	2SC5507 (NE661M04)
2	20	2	17	2	5	2	1.1	1.5		FB	T79	F4TSMM	2SC5508 (NE662M04)
2	50	2	11	2	10	2	1.3	1.7		FB	T80	F4TSMM	2SC5509 (NE663M04)
2	20	2	12.5	2	5	2	1.2	1.5		FB	UA	3USMM	2SC5606 (NE66219)
2	20	2	12.5	2	5	2	–	1.5		FB	UA	F3TUSMM	NE662M03
3	7	1	10	3	7	1	1.4	2.5		EB, FB	C1, C2	3L2MM	2SC5614 (NE856M13)
3	7	1	12	3	7	1	1.4	2.7		EB, FB	D1, D2	3L2MM	2SC5615 (NE681M13)
3	10	2	8.5	3	3	2	1.5	2.5		EB, FB	Y1, Y2	3L2MM	2SC5617 (NE685M13)
3	10	2	8.5 ^{*1}	3	3	2	1.5 ^{*1}	2.5		FB	–	3SLM2	NE685M33
2	20	2	10	2	3	2	1.3	–		EB, FB	W1, W2	3L2MM	2SC5618 (NE687M13)
2	20	2	10 ^{*1}	2	3	2	1.3 ^{*1}	2.5		FB	–	3SLM2	NE687M33

(1) Low Noise Transistors (5/5)

Part Number	Absolute Maximum Ratings (T _A = +25°C)					Electrical Characteristics (T _A = +25°C)											
	V _{CBO} (V)	V _{CEO} (V)	V _{EBO} (V)	I _c (mA)	P _T (mW)	h _{FE}				f _T (GHz)			C _{re} (pF)				
						V _{CE} (V)	I _c (mA)	MIN.	MAX.	V _{CE} (V)	I _c (mA)	TYP.	V _{CB} (V)	I _E (mA)	f (MHz)	TYP.	MAX.
2SC5667 (NE66719)	15	3.3	1.5	35	115	2	5	50	100	2	20	21	2	0	1	0.24	0.3
2SC5668 (NE667M03)	15	3.3	1.5	35	115	2	5	50	100	2	20	21	2	0	1	0.24	0.3
2SC5674	15	3.3	1.5	35	140	2	5	50	100	3	30	21	2	0	1	0.24	0.3
2SC5676 (NE863M03)	9	5.5	1.5	100	200	1	10	100	160	1	10	5.5	0.5	0	1	0.9	1.2
2SC5677 (NE863M13)	9	5.5	1.5	100	140	1	10	100	160	1	10	5.5	0.5	0	1	0.9	1.2
2SC5704 (NE662M16)	15	3.3	1.5	35	115	2	5	50	100	3	30	25	2	0	1	0.18	0.24
2SC5736	15	5	3	100	200	1	5	100	145	1	5	5	0.5	0	1	0.68	0.8
2SC5741	15	5	3	100	200	1	5	100	145	1	5	5	0.5	0	1	0.68	0.8
2SC5745 (NE819M03)	15	5.5	1.5	100	200	1	10	100	145	1	10	5.5	0.5	0	1	0.75	0.85
2SC5746	15	5.5	1.5	100	140	1	10	100	145	1	10	5.5	0.5	0	1	0.75	0.85
2SC5750 (NE67718)	9	6	2	50	200	3	20	75	150	3	20	15	3	0	1	0.26	0.5
2SC5751 (NE677M04)	9	6	2	50	205	3	20	75	150	3	20	15	3	0	1	0.22	0.5
2SC5752 (NE67818)	9	6	2	100	200	3	30	75	150	3	30	12	3	0	1	0.46	0.7
2SC5753 (NE678M04)	9	6	2	100	205	3	30	75	150	3	30	12	3	0	1	0.42	0.7
2SC5786	9	3	1.5	35	115	1	5	50	100	1	20	20	0.5	0	1	0.22	0.3
2SC5787	9	3	1.5	35	115	1	5	50	100	1	20	20	0.5	0	1	0.22	0.3
2SC5800 (NE851M03)	9	5.5	1.5	100	200	1	5	100	145	1	5	4.5	0.5	0	1	0.6	0.8
2SC5801 (ME851M13)	9	5.5	1.5	100	140	1	5	100	145	1	5	4.5	0.5	0	1	0.6	0.8
NE851M33	9	5.5	1.5	100	–	1	5	100	145	1	5	4.5 ^{*1}	0.5	0	1	0.6 ^{*1}	0.8

*1 Preliminary specification

Electrical Characteristics (T _A = +25 °C)										Rank	Marking (h _{FE} value)	Outline	Part Number
S _{21e} ² (dB)				NF					Remarks				
V _{CE} (V)	I _c (mA)	f (GHz)	TYP.	V _{CE} (V)	I _c (mA)	f (GHz)	TYP.	MAX.					
2	20	2	11.5	2	5	2	1.1	1.5		FB	UB	3USMM	2SC5667 (NE66719)
2	20	2	11.5	2	5	2	1.1	1.5		FB	UB	F3TUSMM	2SC5668 (NE667M03)
1	10	2	11	2	5	2	1.1	1.5		FB	C5	3L2MM	2SC5674
1	10	2	4	1	10	2	1.8	3		FB	UC	F3TUSMM	2SC5676 (NE863M03)
1	10	2	4	1	10	2	1.8	3		FB	D5	3L2MM	2SC5677 (NE863M13)
2	20	2	17	2	5	2	1.1	1.5		FB	zC	6L2MM	2SC5704 (NE662M16)
1	5	2	4.5	1	5	2	2	3		FB	TX	F3TUSMM	2SC5736
1	5	2	4.5	1	5	2	2	3		FB	TX	3USMM	2SC5741
1	10	2	4.5	1	10	2	2	3		FB	TY	F3TUSMM	2SC5745 (NE819M03)
1	10	2	4.5	1	10	2	2	3		FB	Y5	3L2MM	2SC5746
3	20	2	13	3	5	2	1.7	2.5	P ₋₁ , G _L , η _c are specified	FB	R54	4SMM	2SC5750 (NE67718)
3	20	2	13.5	3	5	2	1.7	2.5	P ₋₁ , G _L , η _c are specified	FB	R54	F4TUSMM	2SC5751 (NE677M04)
3	30	2	10	3	7	2	1.7	2.5	P ₋₁ , G _L , η _c are specified	FB	R55	4SMM	2SC5752 (NE67818)
3	30	2	10.5	3	7	2	1.7	2.5	P ₋₁ , G _L , η _c are specified	FB	R55	F4TUSMM	2SC5753 (NE678M04)
1	20	2	12	1	5	2	1.4	2.5	P ₋₁ are specified	FB	UE	F3TUSMM	2SC5786
1	20	2	13	1	5	2	1.4	2.5	P ₋₁ are specified	FB	B7	3L2MM	2SC5787
1	5	2	4	1	10	2	1.9	2.5		FB	80	F3TUSMM	2SC5800 (NE851M03)
1	5	2	4	1	10	2	1.9	2.5		FB	E7	3L2MM	2SC5801 (NE851M13)
1	5	2	4 ^{*1}	1	10	2	1.9 ^{*1}	2.5		FB	–	3SLM2	NE851M33

(2) SiGe HBT

Part Number	Absolute Maximum Ratings (T _A = +25°C)					Electrical Characteristics (T _A = +25°C)											
	V _{CB0} (V)	V _{CEO} (V)	V _{EBO} (V)	I _c (mA)	P _T (mW)	h _{FE}				f _T (GHz)			C _{re} (pF)				
						V _{CE} (V)	I _c (mA)	MIN.	MAX.	V _{CE} (V)	I _c (mA)	TYP.	V _{CB} (V)	I _E (mA)	f (MHz)	TYP.	MAX.
2SC5761 (NESG2030M04)	8	1.2	2.3	35	80	2	5	200	400	–	–	–	2	0	1	0.17	0.22
NESG2021M05	13	5	1.5	35	175	2	5	130	260	–	–	–	2	0	1	0.1	–
NESG2031M05	13	5	1.5	35	175	2	5	130	260	–	–	–	2	0	1	0.15	–
NESG2101M05	13	5	1.5	100	500	2	5	130	260	–	–	–	2	0	1	0.4	–

(3) Medium Output Power Transistors

Part Number	Absolute Maximum Ratings (T _A = +25°C)						Electrical Characteristics (T _A = +25°C)													
	V _{CB0} (V)	V _{CER} (V) R = 10 Ω	V _{CEO} (V)	V _{EBO} (V)	I _c (A)	P _T (mW)	P _{out} (dBm)					P _{1dB} (dBm)				η _c (%)				
							f (MHz)	V _{CC} (V)	P _{in} (dBm)	MIN.	TYP.	f (GHz)	I _q (mA)	V _{CE} (V)	TYP.	f (GHz)	P _{in} (dBm)	I _q (mA)	V _{CE} (V)	TYP.
2SC5288 (NE68939)	9	–	6	2	150	200	–	–	–	–	–	1.9	1	3.6	24	1.9	–	1	3.6	60
2SC5289 (NE69039)	9	–	6	2	300	200	–	–	–	–	–	1.9	1	3.6	27	1.9	–	1	3.6	70
2SC5754 (NE664M04)	13	–	5	1.5	500	215	–	–	–	–	–	1.8	20	3.6	26	1.8	15	4	3.6	60

(4) Middle-Power LD-MOS FETs

Part Number	Absolute Maximum Ratings (T _A = +25°C)				Electrical Characteristics (T _A = +25°C)														
	V _{DS} (V)	V _{GS} (V)	I _D (A)	P _{tot} (W)	V _{GS(OFF)} (V)				g _m (S)				P _{out} (dBm)						
					V _{DS} (V)	I _D (mA)	MIN.	MAX.	V _{DS} (V)	I _D (A)	ΔI _D (mA)	MIN.	f (GHz)	V _{DS} (V)	I _{DQ} (mA)	P _{in} (dBm)	MIN.	TYP.	
NE5500179A	20.0	5.0	0.25	10	4.8	1	1.0	2.0	4.8	0.25	–	0.42	1.9	4.8	200	20	28.5	30.0	
NE5500479A	20.0	5.0	1.0	10	4.8	1	1.0	2.0	4.8	0.6	–	1.43	0.9	3.5	300	20	30.5	31.5	
NE5510279A	20.0	5.0	1.0	20	4.8	1	1.0	2.0	4.8	0.6	–	1.5	1.8	4.8	300	25	32.0	33.0	
NE5520279A	15.0	5.0	0.6	12.5	3.5	1	1.0	1.9	3.2	0.7	–	1.3	1.8	3.2	700	25	30.5	32.0	
NE5520379A	15.0	5.0	1.5	20	3.5	1	1.0	2.0	3.5	0.8	0.2	2.5	1.785	3.2	–	25	31.0	33.0	
NE552R479A	15.0	5.0	0.3	10	3.5	1	1.0	1.9	3.5	0.1	–	0.4	2.45	3.0	200	19	24.0	26.0	
NE552R679A	15.0	5.0	0.35	10	3.5	1	1.0	1.9	3.0	0.3	–	0.6	0.46	3.0	300	15	26.0	28.0	

Electrical Characteristics (T _A = +25 °C)										Rank	Marking (h _{FE} value)	Outline	Part Number
S _{21e} ² (dB)				NF					Remarks				
V _{CE} (V)	I _c (mA)	f (GHz)	TYP.	V _{CE} (V)	I _c (mA)	f (GHz)	TYP.	MAX.					
2	20	2	18	2	5	2	0.9	1.1		FB	T16	F4TSMM	2SC5761 (NESG2030M04)
3	10	2	19.0	2	3	5.2	1.3	-		FB	T1G	F4TSMM	NESG2021M05
3	20	2	18.0	2	5	5.2	1.3	-		FB	T1H	F4TSMM	NESG2031M05
3	50	2	13.5	2	10	2	0.9	-		FB	T1J	F4TSMM	NESG2101M05

Electrical Characteristics (T _A = +25°C)										Function	Marking	Outline	Part Number
G _L (dB)					IM ₃ (dBc)								
f (GHz)	P _{in} (dBm)	I _q (mA)	V _{CC} (V)	TYP.	f (GHz)	Δf (kHz)	V _{CC} (V)	I _q (mA)	TYP.				
1.9	-	1	3.6	8	-	-	-	-	-		T89	4MM	2SC5288 (NE68939)
1.9	-	1	3.6	6	-	-	-	-	-		T90	4MM	2SC5289 (NE69039)
1.8	15	20	3.6	12	-	-	-	-	-		R57	F4TSMM	2SC5754 (NE664M04)

Electrical Characteristics (T _A = +25°C)												Marking	Outline	Part Number
η _D (%)						G _L (dB)								
f (GHz)	V _{DS} (V)	I _{DQ} (mA)	P _{in} (dBm)	MIN.	TYP.	f (GHz)	V _{DS} (V)	I _{DQ} (mA)	P _{in} (dBm)	MIN.	TYP.			
1.9	4.8	200	20	48	55	1.9	4.8	200	10	-	14.0	R1	79A	NE5500179A
0.9	3.5	300	20	55	62	0.9	3.5	300	10	-	15.0	R4	79A	NE5500479A
1.8	4.8	300	25	38	47	1.8	4.8	300	10	-	10.0	W2	79A	NE5510279A
1.8	3.2	700	25	40	45	1.8	3.2	800	5	-	10	A2	79A	NE5520279A
1.785	3.2	-	25	-	35	1.785	3.2	-	10	-	8.5	A3	79A	NE5520379A
24.5	3.0	200	19	35	45	2.45	3.0	300	10	-	11	AW	79A	NE552R479A
0.46	3.0	300	15	55	60	0.46	3.0	300	5	-	20	AU	79A	NE552R679A

(5) High-Power LD-MOS FETs

Part Number	Absolute Maximum Ratings (T _A = +25°C)				Electrical Characteristics (T _A = +25°C)														
	V _{DS} (V)	V _{GS} (V)	I _D (A)	P _{tot} (W)	V _{GS(OFF)} (V)				g _m (S)				P _{out} (dBm)						
					V _{DS} (V)	I _D (mA)	MIN.	MAX.	V _{DS} (V)	I _D (A)	ΔI _D (mA)	MIN.	f (GHz)	V _{DS} (V)	I _{DQ} (mA)	P _{in} (dBm)	MIN.	TYP.	
NEM090303M-28	65	+7 -10	8	79.5	10	1	1.0	2.0	28	0.25	-	1.8 (TYP.)	0.96	28	250	28	45	46.5	

(6) Dual Gate MOS FETs

Part Number	Absolute Maximum Ratings (T _A = +25°C)				Electrical Characteristics (T _A = +25°C)																					
	V _{DSX} (V)	V _{G1S} (V)	V _{G2S} (V)	P _T (mW)	V _{DSS(IDSX)} (mA)				V _{G1S(OFF)} (V)				V _{G2S(OFF)} (V)				y _{fs} (mS)				C _{iss} (pF)					
					V _{DS} (V)	V _{G2S} (V)	V _{G1S} (V)	MIN.	MAX.	V _{DS} (V)	V _{G2S} (V)	I _D (μA)	MIN.	MAX.	V _{DS} (V)	V _{G1S} (V)	I _D (μA)	MIN.	MAX.	V _{DS} (V)	V _{G2S} (V)	I _D (mA)	MIN.	TYP.	V _{DS} (V)	V _{G2S} (V)
3SK222 (NE92039)	18	±8	±8	200	6	3	0.75	0.01	8.0	6	3	10	0	+1.0	6	3	10	0	+1.0	5	4	10	15	19.5	6	3
3SK254 (BE93218)	18	±8	±8	150	3.5	3	0.5	0.1	5.0	3.5	3	10	-1.0	+1.0	3.5	3	10	0	+1.0	3.5	3	7	14	23	3.5	3
3SK255 (NE93318)	18	±8	±8	150	3.5	3	0.5	0.5	7.0	3.5	3	10	-1.0	+1.0	3.5	3	10	0	+1.0	3.5	3	7	14	24	3.5	3

(7) Dual Gate GaAs FETs

Part Number	Absolute Maximum Ratings (T _A = +25°C)				Electrical Characteristics (T _A = +25°C)																					
	V _{DSX} (V)	V _{G1S} (V)	V _{G2S} (V)	P _T (mW)	I _{DSS(IDSX)} (mA)				V _{G1S(OFF)} (V)				V _{G2S(OFF)} (V)				y _{fs} (mS)				C _{iss} (pF)					
					V _{DS} (V)	V _{G2S} (V)	V _{G1S} (V)	MIN.	MAX.	V _{DS} (V)	V _{G2S} (V)	I _D (μA)	MIN.	MAX.	V _{DS} (V)	V _{G1S} (V)	I _D (μA)	MIN.	MAX.	V _{DS} (V)	V _{G2S} (V)	I _D (mA)	MIN.	TYP.	V _{DS} (V)	V _{G2S} (V)
3SK299 (NE25118)	13	-4.5	-4.5	120	5	0	0	5	40	5	0	100	-	-3.5	5	0	100	-	-3.5	5	1	10	18	25	5	1

Electrical Characteristics (T _A = +25°C)												Marking	Outline	Part Number
η _D (%)						G _L (dB)								
f (GHz)	V _{DS} (V)	I _{DQ} (mA)	P _{in} (dBm)	MIN.	TYP.	f (GHz)	V _{DS} (V)	I _{DQ} (mA)	P _{in} (dBm)	MIN.	TYP.			
0.96	28	250	28	50	63	0.96	28	250	18	18.5	20	-	3M	NEM090303M-28

Electrical Characteristics (T _A = +25°C)																				Marking (I _{DSS} , I _{DSX})	Outline	Part Number		
C _{iss} (pF)				C _{oss} (pF)						C _{ps} (dB)						NF (dB)								
I _D (mA)	MIN.	TYP.	MAX.	V _{DS} (V)	V _{G2S} (V)	I _D (mA)	MIN.	TYP.	MAX.	V _{DS} (V)	V _{G2S} (V)	I _D (mA)	f (MHz)	MIN.	TYP.	V _{DS} (V)	V _{G2S} (V)	I _D (mA)	f (MHz)				TYP.	MAX.
10	3.6	4.3	5.0	6	3	10	1.0	1.5	2.0	6	4	10	200	21	23	6	4	10	200	1.2	2.0	V21, V22	4MM	3SK222 (NE92039)
7	2.4	2.9	3.4	3.5	3	7	0.9	1.2	1.5	3.5	3	7	470	16	19	3.5	3	7	470	2.0	3.0	U1E	4SMM	3SK254 (NE93218)
7	1.2	1.7	2.2	3.5	3	7	0.5	1.0	1.5	3.5	3	7	900	15	18	3.5	3	7	900	1.8	3.0	U1G	4SMM	3SK255 (NE93318)

Electrical Characteristics (T _A = +25°C)																				Marking (I _{DSS} , I _{DSX})	Outline	Part Number		
C _{iss} (pF)				C _{ross} (pF)						C _{ps} (dB)						NF (dB)								
I _D (mA)	MIN.	TYP.	MAX.	V _{DS} (V)	V _{G2S} (V)	I _D (mA)	MIN.	TYP.	MAX.	V _{DS} (V)	V _{G2S} (V)	I _D (mA)	f (MHz)	MIN.	TYP.	V _{DS} (V)	V _{G2S} (V)	I _D (mA)	f (MHz)				TYP.	MAX.
10	0.5	1.0	1.5	5	1	10	-	0.02	0.03	5	1	10	900	16	20	5	1	10	900	1.1	2.5	U71,U72,U73,U74	4SMM	3SK299 (NE25118)

(8) Twin Transistors (1/2)

Four types of packages suitable for reducing the size of sets are available.

Part Number	Internal Transistor	Absolute Maximum Ratings (T _A = +25°C)					Electrical Characteristics (T _A = +25°C)										
		V _{CBO} (V)	V _{CEO} (V)	V _{EBO} (V)	P _T (mW)	I _C (mA)	h _{FE}				f _T (GHz)			C _{re} (pF)			
							V _{CE} (V)	I _C (mA)	MIN.	MAX.	V _{CE} (V)	I _C (mA)	TYP.	V _{CB} (V)	I _E (mA)	f (MHz)	
μPA800T	2SC5434	20	10	1.5	200	35	3	5	80	200	3	5	8.0	3	0	1	
μPA801T	2SC5432	20	12	3	200	100	3	7	70	250	3	7	4.5	3	0	1	
μPA801TC	2SC5432	20	12	3	230	100	3	7	70	250	3	7	4.5	3	0	1	
μPA802T	2SC5433	20	10	1.5	200	65	3	7	70	240	3	7	7.0	3	0	1	
μPA802TC	2SC5433	20	10	1.5	230	65	3	7	70	150	3	7	7.0	3	0	1	
μPA803T	2SC5005	20	12	3	160	30	5	5	60	200	5	5	5.5	5	0	1	
μPA804T	2SC5431	20	12	3	160	60	5	5	60	200	5	5	5	5	0	1	
μPA805T	2SC5009	9	6	2	120	10	3	5	75	150	3	7	12	3	0	1	
μPA806T	2SC5435	9	6	2	200	30	3	10	75	150	3	10	12	3	0	1	
μPA807T	2SC5181	5	3	2	60	10	2	7	70	140	2	7	13	2	0	1	
μPA808T	2SC5436	5	3	2	180	30	2	20	70	140	2	20	11	2	0	1	
μPA808TC	2SC5436	5	3	2	180	30	2	20	70	140	2	20	11	2	0	1	
μPA809T	2SC5437	9	6	2	200	100	1	3	80	160	3	20	9.0	1	0	1	
μPA810T	2SC5432	20	12	3	200	100	3	7	70	250	3	7	4.5	3	0	1	
μPA811T	2SC5434	20	10	1.5	200	35	3	5	80	250	3	5	-	3	0	1	
μPA812T	2SC5433	20	10	1.5	200	65	3	7	70	240	3	7	7	3	0	1	
μPA813T	2SC5005	20	12	3	160	30	5	5	60	200	5	5	5.5	5	0	1	
μPA814T	2SC5437	9	6	2	200	100	1	3	80	160	3	20	9	1	0	1	
μPA828TC	2SC5436	5	3	2	180	30	2	20	70	140	2	20	11	2	0	1	
μPA831TC	Q1:2SC5432	20	12	3	230	100	3	7	70	140	3	7	4.5	3	0	1	
	Q2:2SC5433	20	10	1.5	230	65	3	7	70	150	3	7	7	3	0	1	
μPA841TD	Q1:2SC5435	9	6	2	210	30	3	10	75	150	3	10	12	3	0	1	
	Q2:2SC5600	9	5.5	1.5	210	100	1	5	100	160	1	5	5	0.5	0	1	
μPA844TC	Q1:2SC5436	5	3	2	205	30	2	20	70	140	2	20	11	2	0	1	
	Q2:2SC5668	15	3.3	1.5	205	35	2	5	50	100	2	20	21	2	0	1	
μPA850TD	Q1:2SC5435	9	6	2	210	30	3	10	75	150	3	10	12	3	0	1	
	Q2:2SC5736	15	5	3	210	100	1	5	100	145	1	5	5.0	0.5	0	1	
μPA851TD	Q1:2SC5737	5	3	2	210	30	1	10	70	140	1	10	12	0.5	0	1	
	Q2:2SC5736	15	5	3	210	100	1	5	100	145	1	5	5.0	0.5	0	1	
μPA854TD	Q1:2SC5435	9	6	2	210	30	3	10	75	150	3	10	12	3	0	1	
	Q2:2SC5745	15	5.5	1.5	210	100	1	10	100	145	1	10	5.5	0.5	0	1	
μPA855TD	Q1:2SC5737	5	3	2	210	30	1	10	70	140	1	10	12	0.5	0	1	
	Q2:2SC5745	15	5.5	1.5	210	100	1	10	100	145	1	10	5.5	0.5	0	1	

Electrical Characteristics (T _A = +25°C)												Rank	Marking	Pin Configuration	Outline	Part Number
C _{re} (pF)		S _{21e} ² (dB)				NF (dB)										
TYP.	MAX.	V _{CE} (V)	I _c (mA)	f (GHz)	MIN.	V _{CE} (V)	I _c (mA)	f (GHz)	TYP.	MAX.						
0.3	0.7	1	3	2	4.5	1	3	2	1.9	3.2	KB	RL	Type 1	6SMM	μPA800T	
0.7	1.5	3	7	1	7	3	7	1	1.2	2.5	FB, GB	R24, R25	Type 1	6SMM	μPA801T	
0.7	1.5	3	7	1	7	3	7	1	1.2	2.5	FB, GB	70, 71	Type 1	F6TUSMM	μPA801TC	
–	0.9	3	7	1	10	3	7	1	1.4	1.7	FB, GB	R34, R35	Type 1	6SMM	μPA802T	
–	0.9	3	7	1	10	3	7	1	1.4	1.7	FB	3A	Type 1	F6TSMM	μPA802TC	
0.7	0.9	5	5	1	5	–	–	–	–	–	FB, GB	T73, T74	Type 1	6SMM	μPA803T	
0.9	1.2	5	5	1	5	–	–	–	–	–	FB, GB	T76, T77	Type 1	6SMM	μPA804T	
0.3	0.5	3	5	2	7	3	3	2	2.5	4	KB	T82	Type 1	6SMM	μPA805T	
0.4	0.7	3	10	2	7	3	3	2	1.5	2.5	KB	T83	Type 1	6SMM	μPA806T	
0.4	0.6	2	7	2	7.5	2	3	2	1.5	2	KB	T84	Type 1	6SMM	μPA807T	
0.4	0.8	2	20	2	7	2	3	2	1.3	2	KB	T86	Type 1	6SMM	μPA808T	
0.4	0.8	2	20	2	7	2	3	2	1.3	2	FB	3C	Type 1	F6TUSMM	μPA808TC	
0.75	0.85	1	3	2	2.5	1	3	2	1.7	2.5	KB	T88	Type 1	6SMM	μPA809T	
0.7	1.5	3	7	1	7	3	7	1	1.2	2.5	FB, GB	24R, 25R	Type 2	6SMM	μPA810T	
–	0.7	3	5	2	5.5	3	5	2	1.9	3.2	FB, GB	44R, 45R	Type 2	6SMM	μPA811T	
–	0.9	3	7	1	10	3	7	1	1.4	2.7	FB, GB	34R, 35R	Type 2	6SMM	μPA812T	
0.7	0.9	5	5	1	5	–	–	–	–	–	FB, GB	73T, 74T	Type 2	6SMM	μPA813T	
0.75	0.85	3	20	2	–	3	7	2	1.5	–	KB	88T	Type 2	6SMM	μPA814T	
0.4	0.8	2	20	2	7	2	3	2	1.3	2	KB	4E	Type 3	F6TUSMM	μPA828TC	
0.7	1.5	3	7	1	7	3	7	1	1.2	2.5	FB	24	Type 4	F6TUSMM	μPA831TC	
–	0.9	3	7	1	10	3	7	1	1.4	2.7						
–	0.9	3	7	1	10	3	7	1	1.4	2.7						
0.4	0.7	3	10	2	7	3	3	2	1.5	2.5	FB	nQ	Type 4	6L2MM	μPA841TD	
0.8	1	1	5	2	3.5	1	5	2	1.5	2.5						
0.4	0.8	2	20	2	7	2	3	2	1.3	2	FB	2D	Type 4	F6TUSMM	μPA844TC	
0.24	0.3	2	20	2	9.5	2	5	2	1.1	1.5						
0.4	0.7	3	10	2	7	3	10	2	1.5	2.5	FB	vF	Type 4	6L2MM	μPA850TD	
0.59	0.75	1	5	2	4.5	1	5	2	2.0	3.0						
0.4	0.7	1	10	2	7	1	3	2	1.5	2	FB	vH	Type 4	6L2MM	μPA851TD	
0.59	0.75	1	5	2	4.5	1	5	2	2.0	3.0						
0.4	0.7	3	10	2	7	3	10	2	1.5	2.5	FB	vL	Type 4	6L2MM	μPA854TD	
0.75	0.85	1	10	2	4.0	1	10	2	2.0	3.0						
0.4	0.7	1	10	2	7	1	3	2	1.5	2	FB	vN	Type 4	6L2MM	μPA855TD	
0.75	0.85	1	10	2	4.0	1	10	2	2.0	3.0						

(8) Twin Transistors (2/2)

Part Number	Internal Transistor	Absolute Maximum Ratings (T _A = +25°C)					Electrical Characteristics (T _A = +25°C)										
		V _{CBO} (V)	V _{CEO} (V)	V _{EB0} (V)	P _T (mW)	I _C (mA)	h _{FE}				f _T (GHz)			C _{re} (pF)			
							V _{CE} (V)	I _C (mA)	MIN.	MAX.	V _{CE} (V)	I _C (mA)	TYP.	V _{CB} (V)	I _E (mA)	f (MHz)	
μPA859TD	Q1:2SC5737	5	3	2	210	30	1	10	70	140	1	10	12	0.5	0	1	
	Q2:2SC5676	9	5.5	1.5	210	100	1	10	100	160	1	10	5.5	0.5	0	1	
μPA860TC	Q1:2SC5435	9	6	2	230	30	3	10	75	150	3	10	12	3	0	1	
	Q2:2SC5786	9	3	1.5	230	35	1	5	50	100	1	20	20	0.5	0	1	
μPA860TD	Q1:2SC5435	9	6	2	210	30	3	10	75	150	3	10	12	3	0	1	
	Q2:2SC5786	9	3	1.5	210	35	1	5	50	100	1	20	20	0.5	0	1	
μPA861TC	Q1:2SC5436	5	3	2	195	30	1	10	70	140	1	10	12	0.5	0	1	
	Q2:2SC5786	9	3	1.5	195	35	1	5	50	100	1	20	20	0.5	0	1	
μPA861TD	Q1:2SC5436	5	3	2	195	30	1	10	70	140	1	10	12	0.5	0	1	
	Q2:2SC5786	9	3	1.5	195	35	1	5	50	100	1	20	20	0.5	0	1	
μPA862TC	Q1:2SC5435	9	6	2	230	30	3	10	75	150	3	10	12	3	0	1	
	Q2:2SC5800	9	5.5	1.5	230	100	1	5	100	145	1	5	4.5	0.5	0	1	
μPA862TD	Q1:2SC5435	9	6	2	210	30	3	10	75	150	3	10	12	3	0	1	
	Q2:2SC5800	9	5.5	1.5	190	100	1	5	100	145	1	5	4.5	0.5	0	1	
μPA862TS	Q1:2SC5435	9	6	2	130	30	3	10	75	150	3	10	12	3	0	1	
	Q2:2SC5800	9	5.5	1.5	130	100	1	5	100	145	1	5	4.5	0.5	0	1	
μPA863TC	Q1:2SC5436	5	3	2	230	30	1	10	70	140	1	10	12	0.5	0	1	
	Q2:2SC5800	9	5.5	1.5	230	100	1	5	100	145	1	5	4.5	0.5	0	1	
μPA863TD	Q1:2SC5436	5	3	2	210	30	1	10	70	140	1	10	12	0.5	0	1	
	Q2:2SC5800	9	5.5	1.5	210	100	1	5	100	145	1	5	4.5	0.5	0	1	
μPA863TS	Q1:2SC5436	5	3	2	130	30	2	20	70	140	2	20	11	2	0	1	
	Q2:2SC5800	9	5.5	1.5	130	100	1	5	100	145	1	5	4.5	0.5	0	1	
μPA872TD	2SC5676	9	5.5	1.5	210	100	1	10	100	160	1	10	5.5	0.5	0	1	
μPA873TC	2SC5800	9	5.5	1.5	230	100	1	5	100	145	1	5	4.5	0.5	0	1	
μPA873TD	2SC5800	9	5.5	1.5	190	100	1	5	100	145	1	5	4.5	0.5	0	1	
μPA873TS	2SC5800	9	5.5	1.5	130	100	1	5	100	145	1	5	4.5	0.5	0	1	
μPA891TC	2SC5600	9	5.5	1.5	230	100	1	5	100	160	1	5	5	0.5	0	1	
μPA891TD	2SC5600	9	5.5	1.5	210	100	1	5	100	160	1	5	5	0.5	0	1	
μPA892TC	2SC5668	15	3.3	1.5	230	35	2	5	50	100	2	20	21	2	0	1	
μPA892TD	2SC5668	15	3.3	1.5	210	35	2	5	50	100	2	20	21	2	0	1	
μPA895TD	2SC5800	9	5.5	1.5	190	100	1	5	100	145	1	5	4.5	0.5	0	1	
μPA895TS	2SC5800	9	5.5	1.5	130	100	1	5	100	145	1	5	4.5	0.5	0	1	

Electrical Characteristics (T _A = +25°C)												Rank	Marking	Pin Configuration	Outline	Part Number
C _{re} (pF)		S _{21e} ² (dB)				NF (dB)										
TYP.	MAX.	V _{CE} (V)	I _c (mA)	f (GHz)	MIN.	V _{CE} (V)	I _c (mA)	f (GHz)	TYP.	MAX.						
0.4	0.7	1	10	2	7	1	3	2	1.5	2	FB	vT	Type 4	6L2MM	μPA859TD	
0.9	1.2	1	10	2	2.5	1	10	2	1.8	3						
0.4	0.7	3	10	2	7	3	3	2	1.5	2.5	FB	2X	Type 4	F6TUSMM	μPA860TC	
0.22	0.3	1	20	2	10	1	5	2	1.4	2.5						
0.4	0.7	3	10	2	7	3	3	2	1.5	2.5	FB	vV	Type 4	6L2MM	μPA860TD	
0.22	0.3	1	20	2	11	1	5	2	1.4	2.5						
0.4	0.8	1	10	2	7	1	3	2	1.5	2	FB	2Y	Type 4	F6TUSMM	μPA861TC	
0.22	0.3	1	20	2	10	1	5	2	1.4	2.5						
0.4	0.8	1	10	2	7	1	3	2	1.5	2	FB	vX	Type 4	6L2MM	μPA861TD	
0.22	0.3	1	20	2	11	1	5	2	1.4	2.5						
0.4	0.7	3	10	2	7	3	3	2	1.5	2.5	FB	5A	Type 4	F6TUSMM	μPA862TC	
0.6	0.8	1	5	2	3	1	10	2	1.9	2.5						
0.4	0.7	3	10	2	7	3	3	2	1.5	2.5	FB	vY	Type 4	6L2MM	μPA862TD	
0.6	0.8	1	5	2	3	1	10	2	1.9	2.5						
0.4	0.7	3	10	2	7	3	10	2	1.5	2.5	FB	vY	Type 4	6SLM2	μPA862TS	
0.6	0.8	1	5	2	3.0	1	10	2	1.9	2.5						
0.4	0.7	1	10	2	7	1	3	2	1.3	2	FB	5B	Type 4	F6TUSMM	μPA863TC	
0.6	0.8	1	5	2	3	1	10	2	1.9	2.5						
0.4	0.7	1	10	2	7	1	3	2	1.3	2	FB	xC	Type 4	6L2MM	μPA863TD	
0.6	0.8	1	5	2	3	1	10	2	1.9	2.5						
0.4	0.8	2	20	2	7	2	3	2	1.3	2	FB	xC	Type 4	6SLM2	μPA863TS	
0.6	0.8	1	5	2	3.0	1	10	2	1.9	2.5						
0.9	1.2	1	10	2	2.5	1	10	2	1.8	3	FB	cD	Type 1	6L2MM	μPA872TD	
0.6	0.8	1	5	2	3	1	10	2	1.9	2.5	FB	3F	Type 1	F6TUSMM	μPA873TC	
0.6	0.8	1	5	2	3	1	10	2	1.9	2.5	FB	cP	Type 1	6L2MM	μPA873TD	
0.6	0.8	1	5	2	3	1	10	2	1.9	2.5	FB	cP	Type 1	6SLM2	μPA873TS	
0.8	1	1	5	2	3.5	1	5	2	1.5	2.5	FB	4B	Type 3	F6TUSMM	μPA891TC	
0.8	1	1	5	2	3.5	1	5	2	1.5	2.5	FB	kH	Type 3	6L2MM	μPA891TD	
0.24	0.3	2	20	2	9.5	2	5	2	1.1	1.5	FB	4C	Type 3	F6TUSMM	μPA892TC	
0.24	0.3	2	20	2	9.5	2	5	2	1.1	1.5	FB	kN	Type 3	6L2MM	μPA892TD	
0.6	0.8	1	5	2	3	1	10	2	1.9	2.5	FB	kP	Type 3	6L2MM	μPA895TD	
0.6	0.8	1	5	2	3	1	10	2	1.9	2.5	FB	kP	Type 3	6SLM2	μPA895TS	

(9) Prescalers

A range of prescalers classified by system, division ratio, pin layout, and package are provided by NEC Compound Semiconductor Devices, Ltd. The lineup features prescalers with frequency characteristics ideal for devices such as mobile communication equipment and BS/CS tuners, as well as those employing a 4.45 mm SSOP package.

Tree Diagram of Prescaler

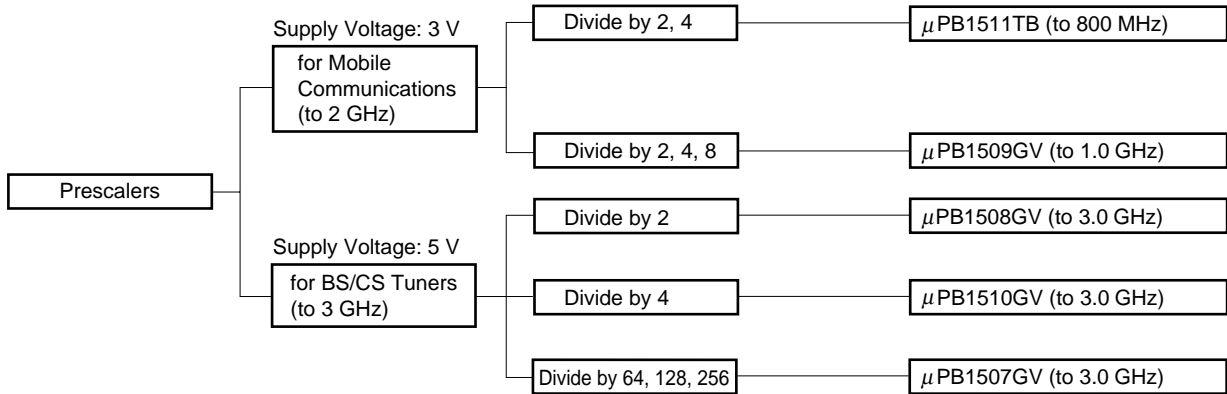

Part Number	Absolute Maximum Ratings (T _A = +25°C)				Electrical Characteristics (V _{CC} = 5 V, T _A = +25°C)										
	V _{CC} (V)	V _{in} (V)	P _d (mW)	T _A (°C)	f _{in(u)1} (GHz)		f _{in(u)2} (GHz)		f _{in(l)1} (GHz)		f _{in(l)2} (GHz)		P _{in1} (dBm)		
					P _{in} (dBm)	MIN.	P _{in} (dBm)	MIN.	P _{in} (dBm)	MAX.	P _{in} (dBm)	MAX.	f _{in} (GHz)	MIN.	MAX.
μPB1507GV	-0.5 to 6	-0.5 to V _{CC} +0.5	*1 250	-40 to +85	-15 to +6	3.0	-	-	-10 to +6	0.5	-15 to +6	1.0	1.0 to 3.0	-15	+6
μPB1508GV	6	6	*1 250	-40 to +85	-10 to +6	3.0	-15 to +6	2.7	-15 to +6	0.5	-	-	2.7 to 3.0	-10	+6
μPB1509GV	*2 6	6	*1 250	-40 to +85	-20 to 0	0.5	-20 to -5	0.7	-20 to 0	0.05	-20 to -5	0.5	0.05 to 1.0	-20	-5
μPB1510GV	6	6	*1 250	-40 to +85	-10 to +6	3.0	-15 to +6	2.7	-15 to +6	0.5	-	-	2.7 to 3.0	-10	+6
μPB1511TB	3.6	3.6	270	-40 to +85	-20 to 0	0.5	-20 to -5	0.7	-20 to 0	0.05	-20 to -5	0.5	0.05 to 0.8	-20	-5

*1 T_A = +85°C, Mounted on double-sided copper-clad epoxy glass board (50 × 50 × 1.6 mm)

*2 V_{CC} = 2.2 to 5.5 V

Electrical Characteristics (V _{CC} = 5 V, T _A = +25°C)														Function	Outline	Part Number
P _{in2} (dBm)			P _{in3} (dBm)			P _{out} (dBm)				I _{CC} (mA)						
f _{in} (GHz)	MIN.	MAX.	f _{in} (GHz)	MIN.	MAX.	f _{in} (GHz)	P _{in} (dBm)	MIN.	TYP.	MIN.	TYP.	MAX.				
0.5 to 1.0	-10	+6	-	-	-	0.5 to 3.0	-10 to +6	1.2 V _{P-P}	1.6 V _{P-P}	12.5	19	26.5	3.0 GHz Divide-by-64, 128, 256 prescaler	8SSOP	μPB1507GV	
0.5 to 2.7	-15	+6	-	-	-	2	0	-12	-7	7.0	10	14.5	3.0 GHz Divide-by-2 prescaler	8SSOP	μPB1508GV	
0.05 to 0.5	-20	0	-	-	-	0.05 to 1.0	-20 to 0	0.1 V _{P-P}	0.2 V _{P-P}	3.5	5.0	5.9	1.0 GHz Divide-by-2, 4, 8 prescaler	8SSOP	μPB1509GV	
0.5 to 2.7	-15	+6	-	-	-	2	0	-12	-7	-	15	-	3.0 GHz Divide-by-4 prescaler	8SSOP	μPB1510GV	
0.05 to 0.5	-20	0	-	-	-	0.05 to 0.8	-20 to 0	0.2 V _{P-P}	0.3 V _{P-P}	3.1	3.5	4.1	800 MHz Divide-by-2, 4 prescaler	6SMM	μPB1511TB	

(10) High-Frequency Amplifiers (1/2)

In response to a variety of marketplace demands, NEC Compound Semiconductor Devices, Ltd. has made available a series of high-frequency amplifier ICs that includes an abundant product lineup. The package range also features a selection ideal for slim and compact applications.

Tree Diagram of High-Frequency Amplifier

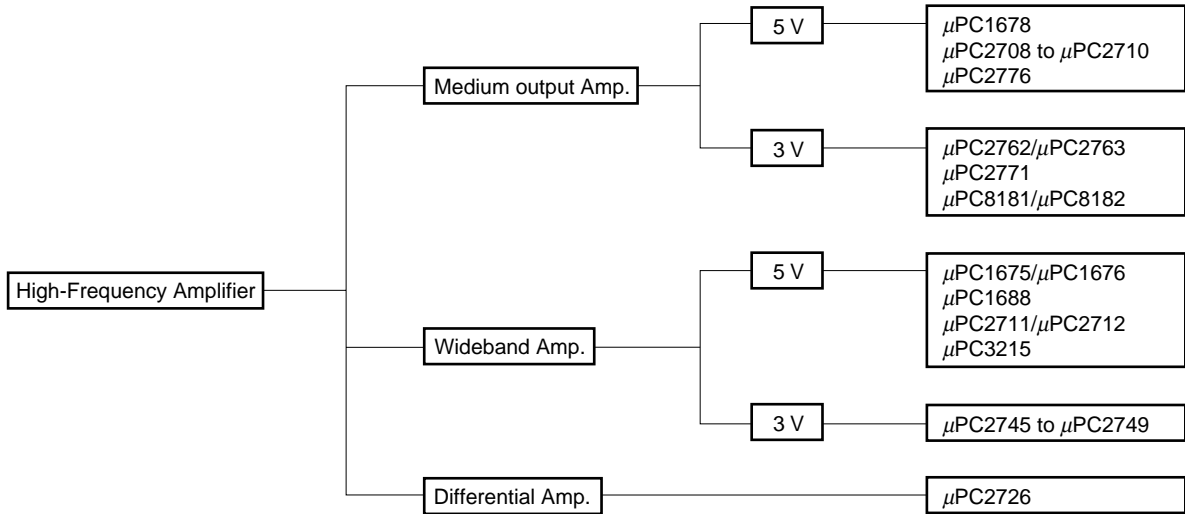

Part Number	Absolute Maximum Ratings (T _A = +25°C)			Electrical Characteristics (T _A = +25 °C)																
	V _{CC} (V)	P _D (mW)	T _A (°C)	I _{CC} (mA) ^{*1}			f _u (GHz) ^{*2}		G _P (dB)			NF (dB)				ISL (dB)				
				V _{CC} (V)	MIN.	TYP.	MAX.	MIN.	TYP.	V _{CC} (V)	f (GHz)	MIN.	TYP.	MAX.	V _{CC} (V)	f (GHz)	TYP.	MAX.	f (GHz)	MIN.
μPC1675G	6	200	-40 to +85	5	12	17	22	1.6	1.9	5	0.5	10	12	14	5	0.5	5.5	7.0	0.5	21
μPC1676G	6	200	-40 to +85	5	14	19	24	1.0	1.2	5	0.5	19	22	24	5	0.5	4.5	6.0	0.5	24
μPC1678GV	6	360 ^{*3}	-45 to +85	5	40	49	60	1.7	2.0	5	0.5	21	23	25	5	0.5	6.0	8.0	0.5	30
μPC1688G	6	200	-40 to +85	5	14	19	24	0.9	1.1	5	0.5	18	21	23	5	0.5	4.0	5.5	0.5	23
μPC2708TB	6	270 ^{*3}	-40 to +85	5	20	26	33	2.7	2.9	5	1	13	15	18.5	5	1.0	6.5	8.0	1	18
μPC2709T μPC2709TB	6	280 ^{*3} 270	-40 to +85	5	19	25	32	2.0	2.3	5	1	21	23	26.5	5	1.0	5	6.5	1	26
μPC2710TB	5.8	270 ^{*3}	-40 to +85	5	16	22	29	0.7	1.0	5	0.5	30	33	36.5	5	1.0	3.5	5.0	0.5	34
μPC2711TB	6	270 ^{*3}	-40 to +85	5	9	12	15	2.7	2.9	5	1	11	13	16.5	5	1.0	5	6.5	1	25
μPC2712T μPC2712TB	6	280 ^{*3} 270	-40 to +85	5	9	12	15	2.2	2.6	5	1	18	20	23.5	5	1.0	4.5	6	1	28
μPC2726T	6	280 ^{*3}	-40 to +85	5	8	11.5	15	1.0	1.6	5	0.4	11	15	17	5	0.4	4.5	6.0	0.4	-

*1 No input signal

*2 Upper limit of operating frequency

*3 T_A = +85°C, Mounted on double-sided copper-clad epoxy glass board (50 × 50 × 1.6 mm)

Electrical Characteristics (T _A = +25°C)												Remarks	Outline	Part Number
ISL (dB)		RL _{in} (dB)			RL _{out} (dB)			P _o (dBm)						
TYP.	f	MIN.	TYP.	f	MIN.	TYP.	f	P _{in}	MIN.	TYP.				
	(GHz)			(GHz)			(GHz)	(dBm)						
25	0.5	9	12	0.5	8	11	0.5	0	2	4		4MM	μPC1675G	
28	0.5	9	12	0.5	6	9	0.5	0	3	5		4MM	μPC1676G	
35	0.5	11	14	0.5	1	4	0.5	+3	+15.5	+17.5	Inductor must be externally equipped with V _{CC} and output pins	8SSOP	μPC1678GV	
27	0.5	10	13	0.5	10	13	0.5	-5	2	4		4MM	μPC1688G	
23	1	8	11	1	16	20	1	0	+7.5	+10	Inductor must be externally equipped with V _{CC} and output pins.	6SMM	μPC2708TB	
31	1	7	10	1	7	10	1	0	+9	+11.5	Inductor must be externally equipped with V _{CC} and output pins.	6MM 6SMM	μPC2709T μPC2709TB	
39	0.5	3	6	0.5	9	12.0	0.5	-8	+11	+13.5	Inductor must be externally equipped with V _{CC} and output pins.	6SMM	μPC2710TB	
30	1	20	25	1	9	12.0	1	0	-2	+1		6SMM	μPC2711TB	
33	1	9	12	1	10	13.0	1	-2	0	+3		6MM 6SMM	μPC2712T μPC2712TB	
60	0.4	-	2.0	0.4	-	4.0	0.4	-10	-5	-2	Only μPC2726T is designed as differential amplifier. ISL = 60 dB TYP.	6MM	μPC2726T	

(10) High-Frequency Amplifiers (2/2)

Part Number	Absolute Maximum Ratings (T _A = +25°C)			Electrical Characteristics (T _A = +25°C)																
	V _{CC} (V)	P _D (mW)	T _A (°C)	I _{CC} (mA) *1			f _u (GHz) *2		G _P (dB)			NF (dB)				ISL (dB)				
				V _{CC} (V)	MIN.	TYP.	MAX.	MIN.	TYP.	V _{CC} (V)	f (GHz)	MIN.	TYP.	MAX.	V _{CC} (V)	f (GHz)	TYP.	MAX.	f (GHz)	MIN.
μPC2745TB	4	270 ^{*3}	-40 to +85	3	5	7.5	10	2.3	2.7	3	0.5	9	12	14	3	0.5	6	7.5	0.5	33
μPC2746TB	4	270 ^{*3}	-40 to +85	3	5	7.5	10	1.1	1.5	3	0.5	16	19	21	3	0.5	4.0	5.5	0.5	40
μPC2747TB	4	270 ^{*3}	-40 to +85	3	3.8	5	7	1.5	1.8	3	0.9	9	12	14	3	0.9	3.3	4.5	0.9	35
μPC2748TB	4	270 ^{*3}	-40 to +85	3	4.5	6	8	1.2	1.5	3	0.9	16	19	21	3	0.9	2.8	4.0	0.9	35
μPC2749TB	4	270 ^{*3}	-40 to +85	3	4	6	8	2.5	2.9	3	1.9	13	16	18.5	3	1.9	4.0	5.5	1.9	25
μPC2762TB	3.6	270 ^{*3}	-40 to +85	3	-	26.5	35	2.7	2.9	3	0.9 1.9	11 11.5	13 14.5	16 17.5	3	0.9 1.9	6.5 7.0	8.0 8.5	0.9 1.9	22 20
μPC2763TB	3.6	270 ^{*3}	-40 to +85	3	-	27	35	2.0	2.4	3	0.9 1.9	18 16.5	20 19.5	23 22.5	3	0.9 1.9	5.5 5.5	7.0 7.0	0.9 1.9	25 24
μPC2771TB	3.6	270 ^{*3}	-40 to +85	3	-	36	45	1.7	2.1	3	0.9 1.5	19 17	21 20	24 23	3	0.9 1.5	6.0 6.0	7.5 7.5	0.9 1.5	25 25
μPC2776TB	6	270 ^{*3}	-40 to +85	5	18	25	33	2.3	2.7	5	1.0	21	23	26	5	1.0	6.0	7.5	1.0	27
μPC3215TB	6	270 ^{*3}	-40 to +85	5	10.5	14	17.5	2.5	2.9	5	1.5	18.5	20.5	-	5	1.5	2.3	3.0	1.5	39
μPC8181TB	3.6	270 ^{*3}	-40 to +85	3	-	23	30	-	4.0	3	0.9 1.9 2.4	16 18 19	19 21 22	22 24 25	3	0.9 1.9 2.4	4.5 4.5 4.5	6.0 6.0 6.0	0.9 1.9 2.4	28 27 26.5
μPC8182TB	3.6	270 ^{*3}	-40 to +85	3	-	30	38	2.6	2.9	3	0.9 1.9 2.4	19 18 18	21.5 20.5 20.5	25 24 24	3	0.9 1.9 2.4	4.5 4.5 5.0	6.0 6.0 6.5	0.9 1.9 2.4	28 27 26

*1 No input signal

*2 Upper limit of operating frequency

*3 T_A = +85°C, Mounted on double-sided copper-clad epoxy glass board (50 × 50 × 1.6 mm)

Electrical Characteristics (T _A = +25°C)												Remarks	Outline	Part Number
ISL (dB)	RL _{in} (dB)			RL _{out} (dB)			P _{O(sat)} (dBm)							
	TYP.	f (GHz)	MIN.	TYP.	f (GHz)	MIN.	TYP.	f (GHz)	P _{in} (dBm)	MIN.	TYP.			
38														
45	0.5	10	13	0.5	5.5	8.5	0.5	-6	-3	0		6SMM	μPC2746TB	
40	0.9	11	14	0.9	7	10	0.9	-8	+9.5	-7		6SMM	μPC2747TB	
40	0.9	8.5	11.5	0.9	5.5	8.5	0.9	-8	-6	-3.5		6SMM	μPC2748TB	
30	1.9	7	10	1.9	9.5	12.5	1.9	-6	-9	-6		6SMM	μPC2749TB	
27 25	0.9 1.9	6.0 5.5	9.0 8.5	0.9 1.9	8.0 9.0	11.0 12.0	0.9 1.9	+3 +3	-	+9.0 +8.5	Inductor must be externally equipped with V _{CC} and output pins.	6SMM	μPC2762TB	
30 29	0.9 1.9	8.0 9.0	11.0 12.0	0.9 1.9	5.0 6.0	8.0 9.0	0.9 1.9	-3 -3	-	+11 +8.0	Inductor must be externally equipped with V _{CC} and output pins.	6SMM	μPC2763TB	
30 30	0.9 1.5	10 10	14 14	0.9 1.5	6.5 5.5	9.5 8.5	0.9 1.9	-3 -3	-	+12.5 +11	Inductor must be externally equipped with V _{CC} and output pins.	6SMM	μPC2771TB	
32	1.0	4.5	7.5	1.0	15	20	1.0	-	+4	+6.5	P _O is specified as output 1dB compression point.	6SMM	μPC2776TB	
44	1.5	10	15	1.5	6.5	9.5	1.5	0	-	+3.5		6SMM	μPC3215TB	
33 32 31.5	0.9 1.9 2.4	4.5 7.5 8.0	7.5 10.5 11.0	0.9 1.9 2.4	6 7 9	9 10 12	0.9 1.9 2.4	-5	-	+9.5 +9.0 +9.0	Inductor must be externally equipped with V _{CC} and output pins.	6SMM	μPC8181TB	
33 32 31	0.9 1.9 2.4	5 7 9	8 10 12	0.9 1.9 2.4	7 8 11	10 11 14	0.9 1.9 2.4	-5	-	+11.0 +10.5 +10.0	Inductor must be externally equipped with V _{CC} and output pins.	6SMM	μPC8182TB	

(11) Down-Converters

<for TV/VCR Tuner>

NEC Compound Semiconductor Devices, Ltd. provides a range of down converters classified by system, density, and package. The lineup features high-frequency characteristics ideal for ground-wave TV/VCR, BS/CS tuners and CATV, and mobile communication. Different types, such as those incorporating an AGC circuit and those employing a compact package, are also available.

Part Number	Absolute Maximum Ratings (T _A = +25°C)			Electrical Characteristics (T _A = +25°C)											
	V _{CC} (V)	P _D (mW)	T _A (°C)	I _{CC} (mA) (UP:VHF/DOWN:UHF)			f _{in} (MHz)	CG ₁ (dB) VHF			f _{in} (MHz)	CG ₂ (dB) UHF			
				MIN.	TYP.	MAX.		MIN.	TYP.	MAX.		MIN.	TYP.	MAX.	
μPC2797GR	11	500 ^{*1}	-20 to +75	9	31	38	45	55	18.5	22	25.5	470	24.5	28	31.5
					31	38	45	470	18.5	22	25.5	890	24.5	28	31.5

*1 T_A = +75°C, Mounted on double-sided copper-clad epoxy glass board (50 × 50 × 1.6 mm)

*2 f_{undes} = f_{des} + 6 MHz, AM100 kHz, 3% Mod

<for DBS Tuner>

Part Number	Absolute Maximum Ratings (T _A = +25°C)			Electrical Characteristics (T _A = +25°C)											
	V _{CC} (V)	P _D (mW)	T _A (°C)	I _{CC} (mA)			f _{in} (MHz)	CG ₁ (dB)			f _{in} (MHz)	CG ₂ (dB)			
				MIN.	TYP.	MAX.		MIN.	TYP.	MAX.		MIN.	TYP.	MAX.	
μPC2721GV	6	250 ^{*1}	-40 to +85	5	29	38	45.5	900	18	21	24	2000	18	21	24

*1 T_A = +85°C, Mounted on double-sided copper-clad epoxy glass board (50 × 50 × 1.6 mm)

*2 f₁ = f_{RF} MHz, f₂ = f_{RF} + 30 MHz, f_{IF} = 480 MHz

Electrical Characteristics (T _A = +25°C)													Remarks	Outline	Part Number
NF ₁ (dB) VHF			NF ₂ (dB) UHF			P _{o(sat)} (dBm)				CM (dBμ) *2					
f _{in} (MHz)	TYP.	MAX.	f _{in} (MHz)	TYP.	MAX.	f _{in} (MHz)	P _{in} (dBm)	MIN.	TYP.	f _{des} (MHz)	TYP.				
55	11	14	470	9.5	12.5	470	0	+7	+10	470	96				
470	11	14	890	10	13	890	0	+7	+10	890	92		20SSOP	μPC2797GR	

Electrical Characteristics (T _A = +25°C)													Remarks	Outline	Part Number
NF ₁ (dB)			NF ₂ (dB)			P _{o(sat)} (dBm)				IM ₃ (dBc) *2					
f _{in} (MHz)	TYP.	MAX.	f _{in} (MHz)	TYP.	MAX.	f _{in} (MHz)	P _{in} (dBm)	MIN.	MAX.	f _{des} (MHz)	TYP.				
900	9	13	2 000	11	15	2 000	0	+2	+7	2 000	38	IF output : Emitter Follower			

<for Mobile Communication>

Part Number	Absolute Maximum Ratings (T _A = +25°C)			Electrical Characteristics (T _A = +25°C)											
	V _{CC} (V)	P _D (mW) ^{*1}	T _A (°C)	I _{CC} (mA)				CG ₁ (dB)			CG ₂ (dB)				
				V _{CC} (V)	MIN.	TYP.	MAX.	f _{RFIn} (MHz)	MIN.	TYP.	MAX.	f _{RFIn} (MHz)	MIN.	TYP.	MAX.
μPC2756TB	5.5	270	-40 to +85	3	3.5	6.0	8.0	900	11	14	17	1 600	11	14	17
μPC2757TB	5.5	270	-40 to +85	3	3.7	5.6	7.7	800	12	15	18	2 000	10	13	16
μPC2758TB	5.5	270	-40 to +85	3	6.6	11	14.8	800	16	19	22	2 000	14	17	20
μPC8112TB	3.6	270	-40 to +85	3	4.9	8.5	11.7	900	11.5	15	17.5	1 900	9.5	13	15.5

*1 T_A = +85°C, Mounted on double-sided copper-clad glass board (50 × 50 × 1.6 mm)

*2 Refer to data sheet of each device.

<for CATV Tuner>

Part Number	Absolute Maximum Ratings (T _A = +25°C)			Electrical Characteristics (T _A = +25°C)											
	V _{CC} (V)	P _D (mW)	T _A (°C)	I _{CC} (mA)				CG _{MAX} (dB)			CG _{MIN} (dB)				
				V _{CC} (V)	MIN.	TYP.	MAX.	16-17 Pin	MIN.	TYP.	MAX.	16-17 pin	MIN.	TYP.	MAX.
μPC2798GR	6	430 ^{*1}	-40 to +85	5	24	35.5	45	short	68	74	76	short	32	39	43
	11 ^{*3}	500 ^{*2}	-40 to +75	9	32	47	60	short	72	78.5	81	short	-	43.5	-
μPC3220GR	6	433 ^{*1}	-40 to +85	5	30.5	40.0	50.5	-	64.5	71.0	73.5	-	18.0	24.0	29.5

*1 T_A = +85°C, Mounted on double-sided copper-clad epoxy glass board (50 × 50 × 1.6 mm)

*2 T_A = +75°C, Mounted on double-sided copper-clad epoxy glass board (50 × 50 × 1.6 mm)

*3 Supply voltage of video amplifier block (Supply voltage of AGC amplifier block equal 5 V).

*4 Input frequency range of AGC amplifier.

Electrical Characteristics (T _A = +25°C)											Outline	Part Number
NF ₁ (dB) *2			NF ₂ (dB) *2			Po _(sat) (dBm)				Remarks		
f _{RFIn} (MHz)			f _{RFIn} (MHz)			f _{RFIn} (MHz)	P _{RFIn} (dBm)					
	TYP.	MAX.		TYP.	MAX.			MIN.	TYP.			
900	10	13	1 600	13	16	1 600	-10	-15	-12	Differential transistor for VCO + Mixer + IF buffer amplifier	6SMM	μPC2756TB
800	10	13	2 000	13	16	2 000	-10	-11	-8	Mixer + IF buffer amplifier	6SMM	μPC2757TB
800	9	12	2 000	13	15	2 000	-10	-7	-4	Mixer + IF buffer amplifier	6SMM	μPC2758TB
900	9	11	1 900	11.2	13.2	1 900	-10	-7	-3	Mixer + Lo buffer amplifier IF output : Open Collector	6SMM	μPC8112TB

Electrical Characteristics (T _A = +25°C)											Outline	Part Number	
GCR (dB)			IIP ₃		IIP ₃		f _{in} (MHz) *4			Remarks			
V _{AGC} (V)			16-17 pin	(dBm)	16-17 pin	(dBm)	-						
	MIN.	TYP.						MIN.	TYP.		MAX.		
1 to 4	26	32	short	-14	open	-8	-	30	-	250		20SSOP	μPC2798GR
			short	-	open	-7.5							
0.5 to 3.0	35	47	-	0	-	-	-	30	-	-7.5		16SSOP	μPC3220GR

(12) Up-Converters

This is a frequency up converter series for transmission-stage of mobile communication equipment. The series includes the μ PC8106, which focuses on low-distortion characteristics, the low-current-consuming μ PC8109, the high-IP₃ μ PC8163 and operates at higher frequency and lower distortion μ PC8172, μ PC8187 by using UHS0 process. Selection can be made based on the system.

Part Number	Absolute Maximum Ratings (T _A = +25°C)			Electrical Characteristics (T _A = +25°C)											
	V _{CC} (V)	P _D (mW) * 1	T _A (°C)	I _{CC} (mA)				CG ₁ (dB)			CG ₂ (dB)				
				V _{CC} (V)	MIN.	TYP.	MAX.	f _{RFout} (MHz)	MIN.	TYP.	MAX.	f _{RFout} (MHz)	MIN.	TYP.	MAX.
μ PC8106TB	6	270	-40 to +85	3	4.5	9	13.5	900	7 6	10 9	13 12	1 900	4	7	10
μ PC8109TB	6	270	-40 to +85	3	2.5	5	8.0	900	4 3	7 6	10 9	1 900	2 1	5 4	8 7
μ PC8163TB	3.6	270	-40 to +85	3	11.5	16.5	23	830	6	9	12	1 900	2.5	5.5	8.5
μ PC8172TB	3.6	270	-40 to +85	3	5.5	9.0	13	900	6.5	9.5	12.5	1 900	5.5	8.5	11.5
μ PC8187TB	3.6	270	-40 to +85	2.8	11	15	19	830	8	11	14	1 900	8	11	14

*1 T_A = +85°C, Mounted on double-sided copper-clad glass board (50 × 50 × 1.6 mm)

*2 Refer to data sheet of each device.

(13) Differential Input/Output Amplifiers

This is a VHF wideband differential input/output amplifier IC that uses a high-frequency process. Package is 8-pin SSOP.

Part Number	Absolute Maximum Ratings (T _A = +25°C)					Electrical Characteristics (V _{CC±} = ±6 V, T _A = +25°C)										
	V _{CC} (V)	V _{ID} (V)	V _{ICM} (V)	T _A (°C)	P _D (mW)	*1 A _{vd}			BW (MHz)	t _r (ns)		t _{pd} (ns)		V _n (μV/r.m.s)		
						MIN.	TYP.	MAX.		TYP.	V _{out} (V _{P-P})	TYP.	V _{out} (V _{P-P})	TYP.	f _{in} (Hz)	TYP.
μ PC1663GV	±7	±5	±6	-45 to +75	*2 280	200	320	500	120	1	2.9	1	2	10 k to 10 M	3	

*1 These performances are adjustable with gain selection terminals. (G_{2A}, G_{2B})

*2 T_A = +75°C, Mounted on double-sided copper-clad epoxy glass board (50 × 50 × 1.6 mm)

Electrical Characteristics (T _A = +25°C)											Outline	Part Number
f _{RFout} (MHz)	NF ₁ (dB) *2		NF ₂ (dB) *2			P _{O(sat)} (dBm)				Remark		
	TYP.	MAX.	f _{RFout} (MHz)	TYP.	MAX.	f _{RFout} (MHz)	P _{RFIn} (dBm)	MIN.	TYP.			
900	8.5	–	–	–	–	1 900	0	–6.5	–4	Matching circuit must be externally equipped with RF output pin.	6SMM	μPC8106TB
900	8.5	–	–	–	–	900	0	–7.5	–5.5	Matching circuit must be externally equipped with RF output pin.	6SMM	μPC8109TB
830	12.5	–	–	–	–	830	0	–1.5	0.5	Matching circuit must be externally equipped with RF output pin.	6SMM	μPC8163TB
900	9.5	–	1900	10.4	–	1 900	0	–3.5	0	Matching circuit must be externally equipped with RF output pin.	6SMM	μPC8172TB
830	11	–	1900	12	–	1 900	0	+2.5	0	Matching circuit must be externally equipped with RF output pin.	6SMM	μPC8187TB

Electrical Characteristics (V _{CC±} = ±6 V, T _A = +25°C)																Outline
V _{cm} (V)	CMR (dB)			SVR (dB)			V _{O(off)} (V)		V _{O(CM)} (V)			I _{sink} (mA)		I _{CC} (mA)		
	f (MHz)	MIN.	TYP.	ΔV (V)	MIN.	TYP.	TYP.	MAX.	MIN.	TYP.	MAX.	MIN.	TYP.	TYP.	MAX.	
±1	0.1	53	94	±0.5	50	70	0.3	1.5	2.4	2.9	3.4	2.5	3.6	13	20	8SSOP

(14) Modulators/Demodulators

As quadrature modulator and demodulator IC series for mobile communication, NEC Compound Semiconductor Devices, Ltd. provides the ICs for W-CDMA. The series consists of μ PC8195K for IF-AGC + quadrature modulator ICs and μ PC8190K and μ PC8194K for IF-AGC + quadrature demodulator ICs. Two type of IF plan can be selectable as the kit use of μ PC8190K and μ PC8191K or μ PC8194K and μ PC8195K.

AGC + IQ Demodulators

Part Number	Main Characteristics (TYP.)	Package	Outline
μ PC8190K	$V_{CC} = 3.0\text{ V}$, $I_{CC} = 9\text{ mA}$, Voltage Gain: 80 dB @ $V_{cont} = 2.5\text{ V}$ / -20 dB @ $V_{cont} = 0.5\text{ V}$ IIP ₃ : -55 dBm @ $V_{cont} = 2.5\text{ V}$ / +5 dBm @ $V_{cont} = 0.5\text{ V}$, NF: 8.0 dB @ $V_{cont} = 2.5\text{ V}$ / 70 dB @ $V_{cont} = 0.5\text{ V}$, IF Local frequency = 760 MHz	IF = 380 MHz	20-pin QFN 0.4 mm pin pitch 20QFN
μ PC8194K		IF = 190 MHz	

AGC + IQ Modulators

Part Number	Main Characteristics (TYP.)	Package	Outline
μ PC8191K	$V_{CC} = 3.0\text{ V}$, $I_{CC} = 31.0\text{ mA}$, IF Local frequency = 760 MHz, OIP ₃ : +17.7 dBm @ Max Gain, P _{out} : -10 dBm @ $V_{cont} = 2.5\text{ V}$ / -85 dBm @ $V_{cont} = 0.5\text{ V}$ I/Q in = 400 mV _{P-P} (Diff.)	IF _{out} = 570 MHz	20-pin QFN 0.4 mm pin pitch 20QFN
μ PC8195K		IF _{out} = 380 MHz	

(15) Variable Gain Amplifiers

NEC Compound Semiconductor Devices, Ltd. provides the following lineup of variable-gain amplifiers for AGC of systems such as those in mobile communication and digital CATV.

Part Number	V _{CC} (V)	I _{CC} (mA)	V _{AGC} (V)	V _{AGC} up vs. Gain	f (GHz)	P _O (1dB)	Output Circuit	Features	Outline
μ PC8119T	2.7 to 3.3	11	0.6 to 2.4	down	0.1 to 1.92	+3	Open Collector	PDC, PHS, etc.	6MM
μ PC8120T	2.7 to 3.3	11	0.6 to 2.4	up	0.1 to 1.92	+3	Open Collector	PDC, PHS, etc.	6MM
μ PC8204TK	2.7 to 3.3	11.5	0 to 3.3	up	0.8 to 2.5	+4	Open Collector	PHS, W-LAN, etc.	6L2MM (1511)
μ PC3206GR	4.5 to 5.5 ^{*1}	34.5 ^{*2}	0 to 5	up	to 0.1	-	Emitter Follower	Digital CATV, etc.	20SSOP
μ PC3217GV	4.5 to 5.5	23	0 to 5	up	0.01 to 0.1	-	Emitter Follower	Digital CATV, etc.	8SSOP
μ PC3218GV	4.5 to 5.5	23	0 to 5	up	0.01 to 0.1	-	Emitter Follower	Digital CATV, etc.	8SSOP
μ PC3219GV	4.5 to 5.5	36.5	0 to 5	up	0.01 to 0.1	-	Emitter Follower	Digital CATV, etc.	8SSOP

*1 Supply voltage of video amplifier block equals 4.5 to 10 V.

*2 Supply voltage of AGC amplifier block and video amplifier block equal 5 V.

(16) Low Current High-Frequency Amplifiers

NEC Compound Semiconductor Devices, Ltd. provides the following lineup of buffer amplifiers for cellular and cordless telephones.

Part Number	V _{CC} (V)	I _{CC} (mA) @3.0 V	1 GHz Output port matching frequency			1.66 GHz Output port matching frequency			1.9 GHz Output port matching frequency			2.4 GHz Output port matching frequency			Outline
			G _p (dB)	ISL (dB)	Po (1dB) (dBm)	G _p (dB)	ISL (dB)	Po (1dB) (dBm)	G _p (dB)	ISL (dB)	Po (1dB) (dBm)	G _p (dB)	ISL (dB)	Po (1dB) (dBm)	
μPC8128TB	2.4 to 3.3	2.8	12.5	39	-4.0	13	39	-4.0	13	37	-4.0	-	-	-	6SMM
μPC8151TB	2.4 to 3.3	4.2	12.5	38	+2.5	15	36	+1.5	15	34	+0.5	-	-	-	6SMM
μPC8152TB	2.4 to 3.3	5.6	23.0	40	-4.5	19.5	36	-8.5	17.5	35	-8.5	-	-	-	6SMM
μPC8178TB μPC8178TK	2.4 to 3.3	1.9	11.0	39 40	-4.0 -5.5	-	-	-	11.5 11.0	40 41	-7.0 -8.0	11.5 11.0	38 42	-7.5 -8.0	6SMM 6L2MM (1511)
μPC8179TB μPC8179TK	2.4 to 3.3	4.0	13.5	44 43	+3.0 +2.0	-	-	-	15.5	42	+1.5 +0.5	15.5 16.0	41 42	+1.0 +0.5	6SMM 6L2MM (1511)

(17) BiCMOS, CMOS PLL Synthesizers

Under development

(18) Bipolar PLL Synthesizers

An IC for GPS receivers that integrates an RF/IF frequency down converter and a PLL frequency synthesizer on a single chip is available from NEC Compound Semiconductor Devices, Ltd. The fixed frequency division eliminates the need for counter data input.

RF/IF Frequency Down-Converter + PLL Frequency Synthesizer IC for GPS Receiver

Part Number	Receive Frequency (MHz)	Reference Frequency (MHz)	2nd IF Frequency (MHz)	VCO Frequency (MHz)	V _{CC} (V)	I _{CC} (mA)	CG (dB)	Outline
μPB1005K	1575.42	16.368	4.092	1636.80 (Fix)	2.7 to 3.3	45	72 to 92	36-pin QFN
μPB1007K	1575.42	16.368	4.092	1636.80 (Fix)	2.7 to 3.3	25	100 to 120	36-pin QFN

6. PACKAGE DIMENSIONS

(Unit : mm)

<p>3L2MM 3-Pin Lead-Less Minimold</p> <p>NE package code : M13</p>	<p>3SLM2 3-Pin Super Lead-Less Minimold</p> <p>NE package code : M33 SOT number : -</p>	<p>3MM 3-Pin Minimold</p> <p>NE package code : 33 SOT number : SOT-23</p>
<p>3PMM 3-Pin Power Minimold</p> <p>NE package code : 34 SOT number : SOT-89</p>	<p>3SMM 3-Pin Super Minimold</p> <p>NE package code : 30 SOT number : SOT-323</p>	<p>3USMM 3-Pin Ultra Super Minimold</p> <p>NE package code : 19 SOT number : -</p>
<p>F3TUSMM Flat-Lead 3-Pin Thin-Type Ultra Super Minimold</p> <p>NE package code : M03 SOT number : -</p>	<p>4MM 4-Pin Minimold (39)</p> <p>NE package code : 39 SOT number : SOT-143</p>	<p>4PMM 4-Pin Power Minimold</p> <p>NE package code : M02 SOT number : SOT-89</p>

(Unit : mm)

<p>4SMM 4-Pin Super Minimold (18)</p> <p>NE package code : 18 SOT number : SOT-343</p>	<p>F4TSSMM Flat-Lead 4-Pin Thin-Type Super Minimold</p> <p>NE package code : M04 SOT number : SOT-343</p>	<p>6L2MM 6-Pin Lead-Less Minimold (1208 PKG)</p> <p>NE package code : M16</p>
<p>6L2MM 6-Pin Lead-Less Minimold (1511 PKG)</p> <p>(Bottom View)</p> <p>Remark values within () are for reference.</p>	<p>6MM 6-Pin Minimold</p> <p>0.2 MIN.</p>	<p>6SMM 6-Pin Super Minimold (M01)</p> <p>NE package code : M01 SOT number : SOT-363</p>
<p>6TSMM 6-Pin Thin-Type Super Minimold</p> <p>0 to 0.1</p>	<p>F6TUSMM Flat-Lead 6-Pin Thin-Type Ultra Super Minimold</p> <p>0.11±0.05</p>	<p>8SOP 8-Pin Plastic SOP (5.72 mm(225))</p> <p>detail of lead end</p>

(Unit : mm)

<p>8SSOP 8-Pin Plastic SSOP (4.45 mm(175))</p> <p>Top view shows 8 pins with dimensions: 2.9±0.1 mm width, pins 1-4 on one side, 5-8 on the other. Detail of lead end shows a 3° lead angle. Side views show dimensions: 1.8 MAX. height, 1.5±0.1 mm lead length, 0.575 MAX. body length, 0.65 mm body width, 0.3±0.05 mm body thickness, 0.10 mm body thickness, 0.1±0.1 mm body thickness, 4.94±0.2 mm body length, 3.2±0.1 mm body length, 0.87±0.2 mm body length, 0.5±0.2 mm body length, 0.15±0.05 mm body length, 0.15±0.05 mm body length.</p>	<p>16SSOP 16-Pin Plastic SSOP (5.72 mm(225))</p> <p>Top view shows 16 pins with dimensions: 5.2±0.3 mm width, pins 1-8 on one side, 9-16 on the other. Detail of lead end shows a 5° lead angle. Side views show dimensions: 1.8 MAX. height, 1.5±0.1 mm lead length, 0.475 MAX. body length, 0.65 mm body width, 0.125±0.075 mm body thickness, 6.4±0.2 mm body length, 4.4±0.2 mm body length, 1.0±0.2 mm body length, 0.5±0.2 mm body length, 0.17±0.05 mm body length, 0.10±0.1 mm body length.</p>	<p>20QFN 20-Pin Plastic QFN</p> <p>Top view shows 20 pins with dimensions: 4.2±0.2 mm width, 4.0±0.2 mm width, 3.0±0.2 mm width, 3.2±0.2 mm width. Side view shows dimensions: 3.2±0.2 mm height, 3.0±0.2 mm height. Bottom view shows dimensions: 0.18±0.05 mm width, 0.30±0.15 mm width, 0.4 mm width.</p>
<p>20SSOP 20-Pin Plastic SSOP (5.72 mm(225))</p> <p>Top view shows 20 pins with dimensions: 6.7±0.3 mm width, pins 1-10 on one side, 11-20 on the other. Detail of lead end shows a 3° lead angle. Side views show dimensions: 1.8 MAX. height, 1.5±0.1 mm lead length, 0.575 MAX. body length, 0.65 mm body width, 0.22±0.05 mm body thickness, 0.10±0.1 mm body thickness, 0.1±0.1 mm body thickness, 6.4±0.2 mm body length, 4.4±0.1 mm body length, 1.0±0.2 mm body length, 0.5±0.2 mm body length, 0.15±0.05 mm body length.</p>	<p>24QFN 24-Pin Plastic QFN</p> <p>Top view shows 24 pins with dimensions: 5.2±0.2 mm width, 5.0±0.2 mm width, 4.0±0.2 mm width, 4.2±0.2 mm width. Side view shows dimensions: 4.2±0.2 mm height, 4.0±0.2 mm height, 1.0 MAX. height. Bottom view shows dimensions: 0.22±0.05 mm width, 0.45±0.15 mm width, 0.5 mm width.</p>	<p>28QFN 28-Pin Plastic QFN</p> <p>Top view shows 28 pins with dimensions: 5.5±0.2 mm width, 5.1±0.2 mm width, 4.0±0.2 mm width, 5.1±0.2 mm width. Side view shows dimensions: 5.1±0.2 mm height, 4.7±0.2 mm height. Bottom view shows dimensions: 0.24±0.05 mm width, 0.55±0.20 mm width, 0.5 mm width, 0.5 mm width, 0.6±0.6 mm width, 0.5 mm width, 0.5 mm width.</p>
<p>36QFN 36-Pin Plastic QFN</p> <p>Top view shows 36 pins with dimensions: 6.2±0.2 mm width, 6.0±0.2 mm width, 6.0±0.2 mm width, 6.2±0.2 mm width. Side view shows dimensions: 6.2±0.2 mm height, 6.0±0.2 mm height. Bottom view shows dimensions: 0.22±0.05 mm width, 0.55±0.2 mm width, 0.5 mm width.</p>	<p>μ-X μ-X</p> <p>Top view shows dimensions: 3.8 MIN. width, 3.8 MIN. width, 3.8 MIN. width, 3.8 MIN. width, 0.5±0.05 mm width, 45° angle. Side view shows dimensions: 0.5±0.05 mm height, 0.5±0.05 mm height. Bottom view shows dimensions: 2.55±0.2 mm width, φ2.1 mm diameter, 0.55 mm width, 1.8 MAX. height, 0.1±0.05 mm width.</p>	<p>79A 79A</p> <p>Top view shows dimensions: 4.2 MAX. width, 5.7 MAX. width, 0.6±0.15 mm width, 0.8±0.15 mm width, 4.4 MAX. width, 0.4±0.15 mm width, 5.7 MAX. width. Side view shows dimensions: 0.9±0.2 mm height, 0.2±0.1 mm height. Bottom view shows dimensions: 1.0 MAX. width, 1.5±0.2 mm width, 0.8 MAX. width, 3.6±0.2 mm width, 1.2 MAX. width.</p>

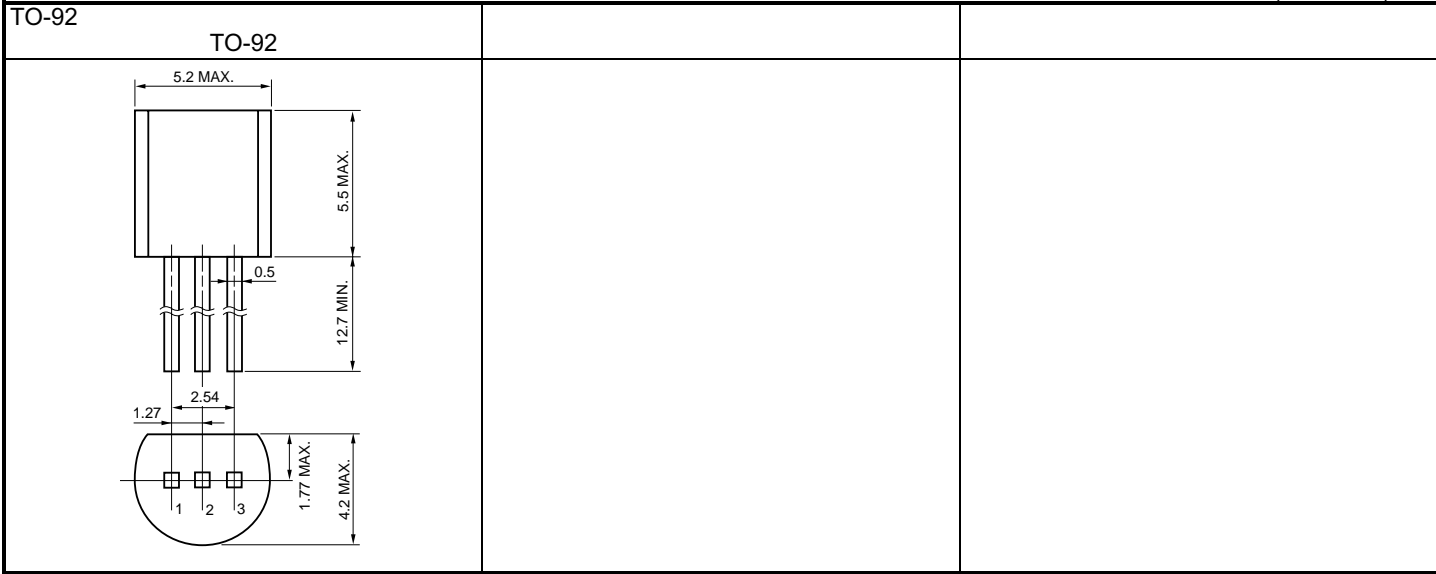

7. MOUNTING PAD LAYOUT

(Unit : mm)

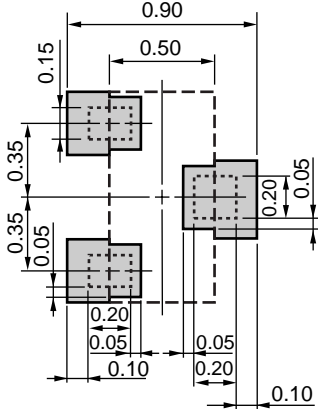
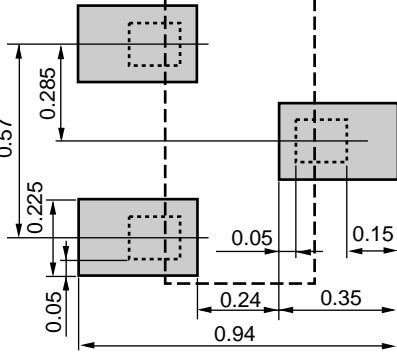
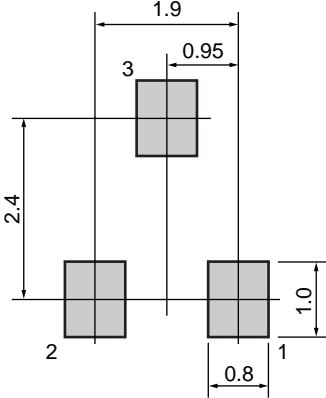
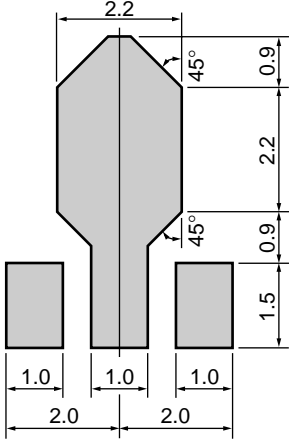
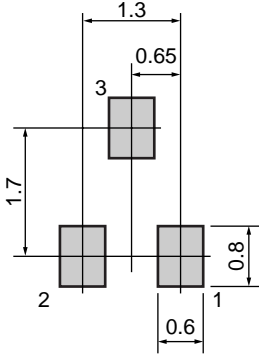
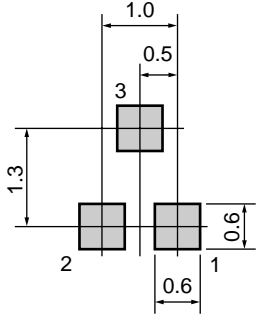
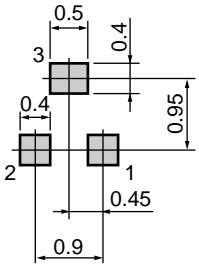
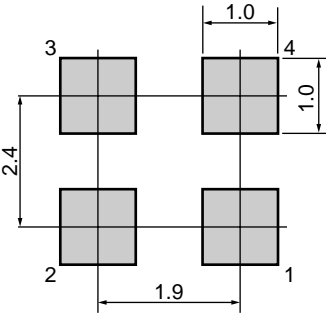
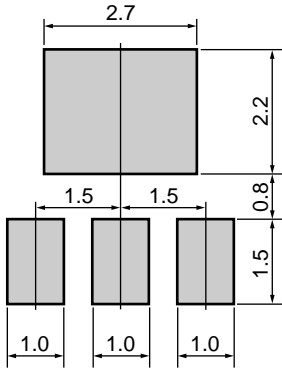
<p>3-Pin Lead-Less Minimold</p>  <p>Remark --- : Mold package : Lead</p>	<p>3-Pin Super Lead-Less Minimold (0804)</p>  <p>Remark --- : Mold package : Lead</p>	<p>3-Pin Minimold</p> 
<p>3-Pin Power Minimold</p> 	<p>3-Pin Super Minimold</p> 	<p>3-Pin Ultra Super Minimold</p> 
<p>Flat-Lead 3-Pin Thin-Type Ultra Super Minimold</p>	<p>4-Pin Minimold (39)</p>	<p>4-Pin Power Minimold</p>
		

Remark The mounting pad layouts in this document are for reference only.

(Unit : mm)

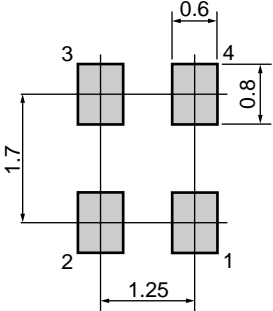
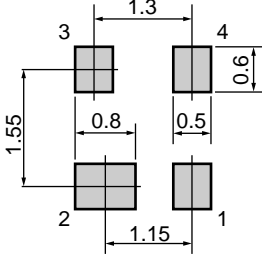
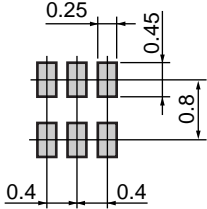
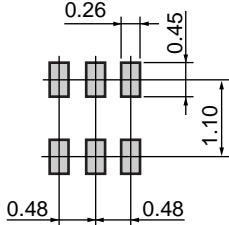
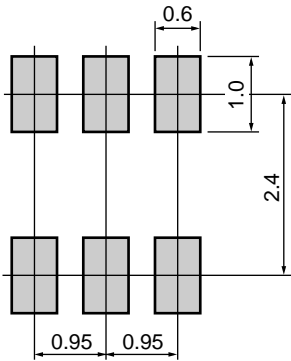
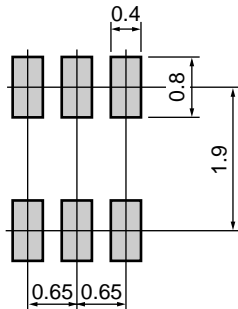
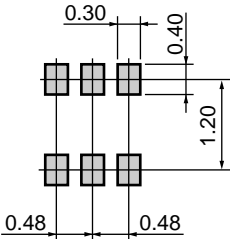
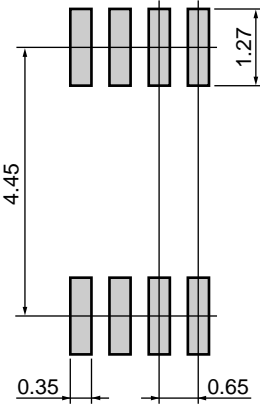
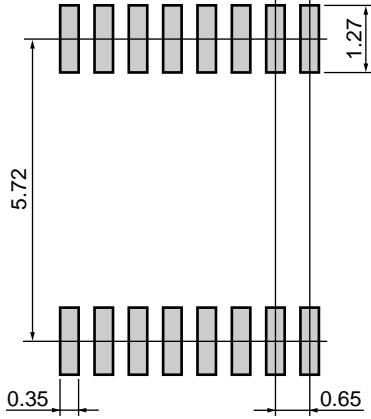
<p>4-Pin Super Minimold (18)</p> 	<p>Flat-Lead 4-Pin Thin-Type Super Minimold</p> 	<p>6-Pin Lead-Less Minimold (1208 PKG)</p> 
<p>6-Pin Lead-Less Minimold (1511 PKG) for Silicon MMIC/GaAs MMIC</p> 	<p>6-Pin Minimold</p> 	<p>6-Pin Super Minimold (M01)</p> 
<p>Flat-Lead 6-Pin Thin-Type Ultra Super Minimold</p> 	<p>8-Pin Plastic SSOP (4.45 mm (175))</p> 	<p>16-Pin Plastic SSOP (5.72 mm (225))</p> 

(Unit : mm)

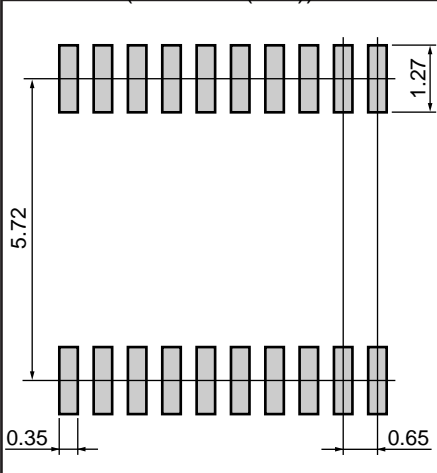
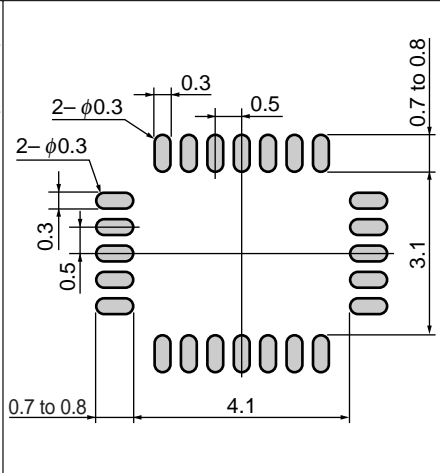
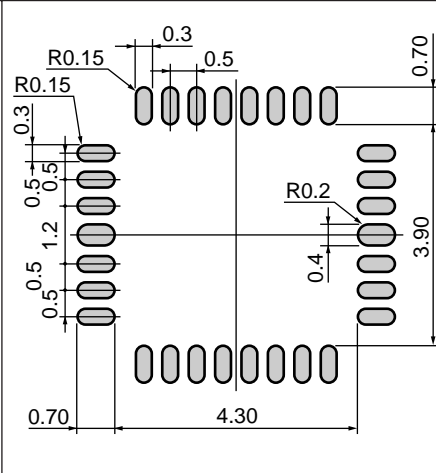
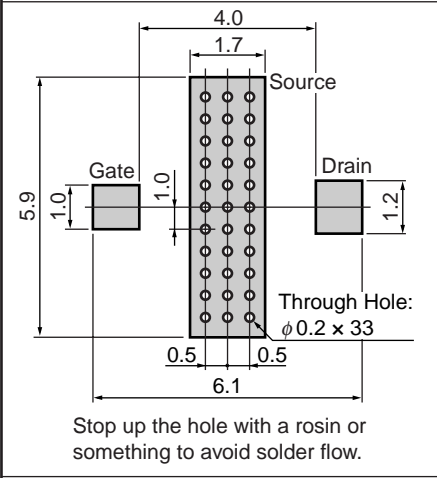
20-Pin Plastic SSOP (5.72 mm (225))	24-Pin Plastic QFN	28-Pin Plastic QFN
		
79A		
 <p>Stop up the hole with a rosin or something to avoid solder flow.</p>		

8. MARKING, h_{FE} RANK INFORMATION FOR MINIMOLD DEVICES

(1) Bipolar Transistors (1/3)

Part Number	Old Specification	New Specification	Marking	Specification	Part Number	Old Specification	New Specification	Marking	Specification
2SA1977	–	FB	T92	h _{FE} = 20 to 100	2SC4228	R43	–	R43	h _{FE} = 50 to 100
2SA1978	–	FB	T93	h _{FE} = 20 to 100		R44	–	R44	h _{FE} = 80 to 160
2SC2570A	E	–	E	h _{FE} = 40 to 200		R45	–	R45	h _{FE} = 125 to 250
2SC3355	K	–	K	h _{FE} = 50 to 300	2SC4536	QR	–	QR	h _{FE} = 60 to 120
2SC3356	R23	Q	R23	h _{FE} = 50 to 100		QS	–	QS	h _{FE} = 100 to 200
	R24	R	R24	h _{FE} = 80 to 160	2SC4570	T72	–	T72	h _{FE} = 40 to 80
	R25	S	R25	h _{FE} = 125 to 250		T73	–	T73	h _{FE} = 60 to 120
2SC3357	RH	–	RH	h _{FE} = 50 to 100		T74	–	T74	h _{FE} = 100 to 200
	RF	–	RF	h _{FE} = 80 to 160	2SC4571	T75	–	T75	h _{FE} = 40 to 80
	RE	–	RE	h _{FE} = 125 to 250		T76	–	T76	h _{FE} = 60 to 120
2SC3582	K	–	K	h _{FE} = 50 to 250		T77	–	T77	h _{FE} = 100 to 200
2SC3583	R33	Q	R33	h _{FE} = 50 to 100	2SC4703	SH	–	SH	h _{FE} = 50 to 100
	R34	R	R34	h _{FE} = 80 to 160		SF	–	SF	h _{FE} = 80 to 160
	R35	S	R35	h _{FE} = 125 to 250		SE	–	SE	h _{FE} = 125 to 250
2SC3585	R43	Q	R43	h _{FE} = 50 to 100	2SC4955	T83	FB	T83	h _{FE} = 75 to 150
	R44	R	R44	h _{FE} = 80 to 160					
	R45	S	R45	h _{FE} = 125 to 250	2SC4957	T83	–	T83	h _{FE} = 75 to 150
2SC4093	R26	RBF	R26	h _{FE} = 50 to 100	2SC4959	T83	–	T83	h _{FE} = 75 to 150
	R27	RBG	R27	h _{FE} = 80 to 160	2SC5004	–	FB	77	h _{FE} = 60 to 120
	R28	RBH	R28	h _{FE} = 125 to 250					
2SC4094	R36	RCF	R36	h _{FE} = 50 to 100	2SC5005	–	FB	73	h _{FE} = 60 to 120
	R37	RCG	R37	h _{FE} = 80 to 160					
	R38	RCH	R38	h _{FE} = 125 to 250	2SC5006	–	FB	24	h _{FE} = 80 to 160
2SC4095	R46	RDF	R46	h _{FE} = 50 to 100					
	R47	RDG	R47	h _{FE} = 80 to 160	2SC5007	–	FB	34	h _{FE} = 80 to 160
	R48	RDH	R48	h _{FE} = 125 to 250					
2SC4226	R23	–	R23	h _{FE} = 40 to 80	2SC5008	–	FB	44	h _{FE} = 80 to 160
	R24	–	R24	h _{FE} = 70 to 140					
	R25	–	R25	h _{FE} = 125 to 250	2SC5010	–	FB	83	h _{FE} = 75 to 150
2SC4227	R33	–	R33	h _{FE} = 40 to 90					
	R34	–	R34	h _{FE} = 70 to 150	2SC5011	–	EB	R26	h _{FE} = 50 to 100
	R35	–	R35	h _{FE} = 110 to 240		–	FB	R27	h _{FE} = 80 to 160
						–	GB	R28	h _{FE} = 125 to 250
					2SC5012	–	EB	R36	h _{FE} = 50 to 100
						–	FB	R37	h _{FE} = 80 to 160
						–	GB	R38	h _{FE} = 125 to 250

(1) Bipolar Transistors (2/3)

Part Number	Specification	Marking	Specification	Part Number	Specification	Marking	Specification
2SC5013	EB	R46	$h_{FE} = 50$ to 100	2SC5437	EB	TS	$h_{FE} = 80$ to 110
	FB	R47	$h_{FE} = 80$ to 160		FB	TT	$h_{FE} = 100$ to 145
	GB	R48	$h_{FE} = 125$ to 250	2SC5454	FB	R54	$h_{FE} = 75$ to 150
2SC5015	KB	T83	$h_{FE} = 75$ to 150	2SC5455	FB	R55	$h_{FE} = 75$ to 150
2SC5180	FB	T84	$h_{FE} = 70$ to 140	2SC5507	FB	T78	$h_{FE} = 50$ to 100
2SC5181	FB	84	$h_{FE} = 70$ to 140	2SC5508	FB	T79	$h_{FE} = 50$ to 100
2SC5185	FB	T86	$h_{FE} = 70$ to 140	2SC5509	FB	T80	$h_{FE} = 50$ to 100
2SC5186	FB	86	$h_{FE} = 70$ to 140	2SC5606	FB	UA	$h_{FE} = 60$ to 100
2SC5191	FB	T88	$h_{FE} = 80$ to 160	2SC5614	EB	C1	$h_{FE} = 80$ to 110
2SC5192	FB	T88	$h_{FE} = 80$ to 160	FB	C2	$h_{FE} = 100$ to 145	
2SC5193	FB	T88	$h_{FE} = 80$ to 160	2SC5615	EB	D1	$h_{FE} = 80$ to 110
2SC5194	FB	T88	$h_{FE} = 80$ to 160	FB	D2	$h_{FE} = 100$ to 145	
2SC5195	FB	88	$h_{FE} = 80$ to 160	2SC5617	EB	Y1	$h_{FE} = 75$ to 110
2SC5336	RH	RH	$h_{FE} = 50$ to 100	2SC5618	EB	W1	$h_{FE} = 70$ to 110
	RF	RF	$h_{FE} = 80$ to 160		FB	W2	$h_{FE} = 90$ to 130
	RE	RE	$h_{FE} = 125$ to 250	2SC5667	FB	UB	$h_{FE} = 50$ to 100
2SC5337	QQ	QQ	$h_{FE} = 40$ to 80	2SC5668	FB	UB	$h_{FE} = 50$ to 100
	QR	QR	$h_{FE} = 60$ to 120	2SC5674	FB	C5	$h_{FE} = 50$ to 100
	QS	QS	$h_{FE} = 100$ to 200	2SC5676	FB	UC	$h_{FE} = 100$ to 160
2SC5338	SH	SH	$h_{FE} = 50$ to 100	2SC5677	FB	D5	$h_{FE} = 100$ to 160
	SF	SF	$h_{FE} = 80$ to 160	2SC5704	FB	zC	$h_{FE} = 50$ to 100
	SE	SE	$h_{FE} = 125$ to 250	2SC5736	FB	TX	$h_{FE} = 100$ to 145
2SC5369	FB	T95	$h_{FE} = 80$ to 160	2SC5741	FB	TX	$h_{FE} = 100$ to 145
2SC5431	EB	TA	$h_{FE} = 60$ to 90	2SC5745	FB	TY	$h_{FE} = 100$ to 145
	FB	TB	$h_{FE} = 80$ to 120	2SC5746	FB	Y5	$h_{FE} = 100$ to 145
2SC5432	EB	TC	$h_{FE} = 80$ to 110	2SC5750	FB	R54	$h_{FE} = 75$ to 150
	FB	TD	$h_{FE} = 100$ to 145	2SC5751	FB	R54	$h_{FE} = 75$ to 150
2SC5433	EB	TE	$h_{FE} = 80$ to 110	2SC5752	FB	R55	$h_{FE} = 75$ to 150
	FB	TF	$h_{FE} = 100$ to 145	2SC5753	FB	R55	$h_{FE} = 75$ to 150
2SC5434	EB	TH	$h_{FE} = 80$ to 110				
	FB	TJ	$h_{FE} = 100$ to 145				
2SC5435	EB	TK	$h_{FE} = 75$ to 110				
	FB	TL	$h_{FE} = 95$ to 140				
2SC5436	EB	TN	$h_{FE} = 75$ to 100				
	FB	TP	$h_{FE} = 90$ to 130				

(1) Bipolar Transistors (3/3)

Part Number	Specification	Marking	Specification	Part Number	Specification	Marking	Specification
2SC5754	FB	R57	$h_{FE} = 40$ to 100	NE662M03	FB	UA	$h_{FE} = 60$ to 100
2SC5786	FB	UE	$h_{FE} = 50$ to 100	NE685M33	FB	–	$h_{FE} = 75$ to 150
2SC5787	FB	B7	$h_{FE} = 50$ to 100	NE687M33	FB	–	$h_{FE} = 70$ to 140
2SC5800	FB	80	$h_{FE} = 100$ to 145	NE851M33	FB	–	$h_{FE} = 100$ to 145
2SC5801	FB	E7	$h_{FE} = 100$ to 145				

(2) SiGe HBT

Part Number	Specification	Marking	Specification	Part Number	Specification	Marking	Specification
2SC5761	FB	T16	$h_{FE} = 200$ to 400	NESEG2031M05	FB	T1H	$h_{FE} = 130$ to 260
NESEG2021M05	FB	T1G	$h_{FE} = 130$ to 260	NESEG2101M05	FB	T1J	$h_{FE} = 130$ to 260

(3) Dual Gate FETs

Part Number	Old Specification	New Specification	Marking	Specification	Part Number	Old Specification	New Specification	Marking	Specification
3SK206 (GaAs)	U76	–	U76	$I_{DSS} = 10$ to 25 mA	3SK254	–	U1E	U1E	$I_{DSX} = 0.1$ to 5.0 mA
	U77	–	U77	$I_{DSS} = 20$ to 35 mA	3SK255	–	U1G	U1G	$I_{DSX} = 0.5$ to 7.0 mA
	U78	–	U78	$I_{DSS} = 30$ to 50 mA		3SK299	U71	–	U71
	U79	–	U79	$I_{DSS} = 45$ to 80 mA	U72		–	U72	$I_{DSS} = 10$ to 25 mA
3SK222	V21	VBA	V21	$I_{DSX} = 0.01$ to 3 mA	U73	–	U73	U73	$I_{DSS} = 20$ to 35 mA
	V22	VBB	V22	$I_{DSX} = 1$ to 8 mA	U74	–	U74	U74	$I_{DSS} = 30$ to 40 mA

(4) Middle-Power LD-MOS FETs (79A Package)

Marking	Part Number
R1	NE5500179A
R4	NE5500479A
W2	NE5510279A
A2	NE5520279A
A3	NE5520379A
AW	NE552R479A
AU	NE552R679A

9. MARKINGS VS. PART NO. ON HIGH-FREQUENCY IC OF 4-PIN/6-PIN/SUPER MINIMOLD

Marking	Part Number	Marking	Part Number	Marking	Part Number
C1A	μ PC1675G	C2A	μ PC2763TB	C3A	μ PC8172TB
C1B	μ PC1676G	C2D	μ PC8106TB	C3B	μ PC8178TB
C1C	μ PC1688G	C2G	μ PC8109TB	C3C	μ PC8179TB
C1D	μ PC2708TB	C2H	μ PC2771TB	C3E	μ PC8181TB
C1E	μ PC2709T/TB	C2K	μ PC8112TB	C3F	μ PC8182TB
C1F	μ PC2710TB	C2L	μ PC2776TB	C3G	μ PC8187TB
C1G	μ PC2711TB	C2M	μ PC8119T	C3H	μ PC3215TB
C1H	μ PC2712T/TB	C2N	μ PC8120T	6B	μ PC8178TK
C1P	μ PC2726T	C2P	μ PC8128TB	6C	μ PC8179TK
C1Q	μ PC2745TB	C2S	μ PC2791TB		
C1R	μ PC2746TB	C2T	μ PC2792TB		
C1S	μ PC2747TB	C2U	μ PC8151TB		
C1T	μ PC2748TB	C2V	μ PC8152TB		
C1U	μ PC2749TB	C2Y	μ PC8163TB		
C1W	μ PC2756TB	C2Z	μ PB1511TB		
C1X	μ PC2757TB				
C1Y	μ PC2758TB				
C1Z	μ PC2762TB				

Remark Each part number has a marking one by one. This marking is to know part number and has no other meaning. The marking is three or two letters but not part number because minimold package is too small to mark number over three letters. When the part number has plural size packages, part number has plural package codes but only one marking.

REMARKS PACKAGE CODE ON MINIMOLD (μ P Part number case)

Product released before 1990	Product released between 1990 and April 1996	Product released after April 1996
'G' only	'T' only	Minimold : TA Super minimold : TB Flat-lead thin-type ultra super minimold : TC Thin-type super minimold : TF Lead-less minimold : TK

Remark 2SC and 3SK have no package code.

SUNSTAR商斯达实业集团是集研发、生产、工程、销售、代理经销、技术咨询、信息服务等为一体的高科技企业，是专业高科技电子产品生产厂家，是具有10多年历史的专业电子元器件供应商，是中国最早和最大的仓储式连锁规模经营大型综合电子零部件代理分销商之一，是一家专业代理和分销世界各大品牌IC芯片和电子元器件的连锁经营综合性国际公司。在香港、北京、深圳、上海、西安、成都等全国主要电子市场设有直属分公司和产品展示展销窗口门市部专卖店及代理分销商，已在全国范围内建成强大统一的供货和代理分销网络。我们专业代理经销、开发生产电子元器件、集成电路、传感器、微波光电元器件、工控机/DOC/DOM电子盘、专用电路、单片机开发、MCU/DSP/ARM/FPGA软件硬件、二极管、三极管、模块等，是您可靠的一站式现货配套供应商、方案提供商、部件功能模块开发配套商。专业以现代信息产业（计算机、通讯及传感器）三大支柱之一的传感器为主营业务，专业经营各类传感器的代理、销售生产、网络信息、科技图书资料及配套产品设计、工程开发。我们的专业网站——**中国传感器科技信息网（全球传感器数据库）www.SENSOR-IC.COM** 服务于全球高科技生产商及贸易商，为企业科技产品开发提供技术交流平台。欢迎各厂商互通有无、交换信息、交换链接、发布寻求代理信息。欢迎国外高科技传感器、变送器、执行器、自动控制产品厂商介绍产品到**中国**，共同开拓市场。本网站是关于各种传感器-变送器-仪器仪表及工业自动化大型专业网站，深入到工业控制、系统工程计 测量、自动化、安防报警、消费电子等众多领域，把最新的传感器-变送器-仪器仪表买卖信息，最新技术供求，最新采购商，行业动态，发展方向，最新的技术应用和市场资讯及时的传递给广大科技开发、科学研究、产品设计人员。本网站已成功为石油、化工、电力、医药、生物、航空、航天、国防、能源、冶金、电子、工业、农业、交通、汽车、矿山、煤炭、纺织、信息、通信、IT、安防、环保、印刷、科研、气象、仪器仪表等领域从事科学研究、产品设计、开发、生产制造的科技人员、管理人员、和采购人员提供满意服务。**我公司专业生产、代理、经销、销售各种传感器、变送器、敏感元器件、开关、执行器、仪器仪表、自动化控制系统：**专业从事设计、生产、销售各种传感器、变送器、各种测控仪表、热工仪表、现场控制器、计算机控制系统、数据采集系统、各类环境监控系统、专用控制系统应用软件以及嵌入式系统开发及应用等工作。如热敏电阻、压敏电阻、温度传感器、温度变送器、湿度传感器、湿度变送器、气体传感器、气体变送器、压力传感器、压力变送、称重传感器、物（液）位传感器、物（液）位变送器、流量传感器、流量变送器、电流（压）传感器、溶氧传感器、霍尔传感器、图像传感器、超声波传感器、位移传感器、速度传感器、加速度传感器、扭距传感器、红外传感器、紫外传感器、火焰传感器、激光传感器、振动传感器、轴角传感器、光电传感器、接近传感器、干簧管传感器、继电器传感器、微型电泵、磁敏（阻）传感器、压力开关、接近开关、光电开关、色标传感器、光纤传感器、齿轮测速传感器、时间继电器、计数器、计米器、温控仪、固态继电器、调压模块、电磁铁、电压表、电流表等特殊传感器。同时承接传感器应用电路、产品设计和自动化工程项目。

欢迎索取免费详细资料、设计指南和光盘；产品凡多，未能尽录，欢迎来电查询。

更多产品请看本公司产品专用销售网站：

商斯达中国传感器科技信息网：<http://www.sensor-ic.com/>

商斯达工控安防网：<http://www.pc-ps.net/>

商斯达电子元器件网：<http://www.sunstare.com/>

商斯达微波光电产品网：[HTTP://www.rfoe.net/](http://www.rfoe.net/)

商斯达消费电子产品网：<http://www.icasic.com/>

商斯达军工产品网：<http://www.junpinic.com/>

商斯达实业科技产品网：<http://www.sunstars.cn/>传感器销售热线：

地址：深圳市福田区福华路福庆街鸿图大厦1602室

电话：0755-83607652 83376489 83376549 83370250 83370251 82500323

传真：0755-83376182 (0) 13902971329 MSN: SUNS888@hotmail.com

邮编：518033 E-mail: szss20@163.com QQ: 195847376

深圳赛格展销部：深圳华强北路赛格电子市场2583号 电话：0755-83665529

技术支持：0755-83394033 13501568376