

## 一) 功能特性

- 1) 工作電壓1.5V, 超低電源功耗
- 2) 可顯示室內溫度, 室外溫度 和室內濕度
- 3) 最大最小溫度和濕度記錄功能
- 4) 五段濕度舒適度顯示
- 5) 室內溫度測量範圍: -10~+50 degC(14~122degF)  
室外溫度測量範圍: -20~+70 degC(-4~158degF)  
溫度顯示精度: 0.1degC  
溫度準確度: +/- 1 degC
- 6) 濕度測量範圍: 20~90 %RH  
濕度顯示精度: 1 %RH  
濕度準確度: +/-5 %RH

## 二) 液晶顯示圖案

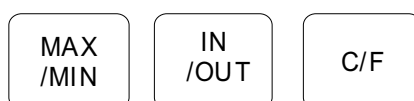
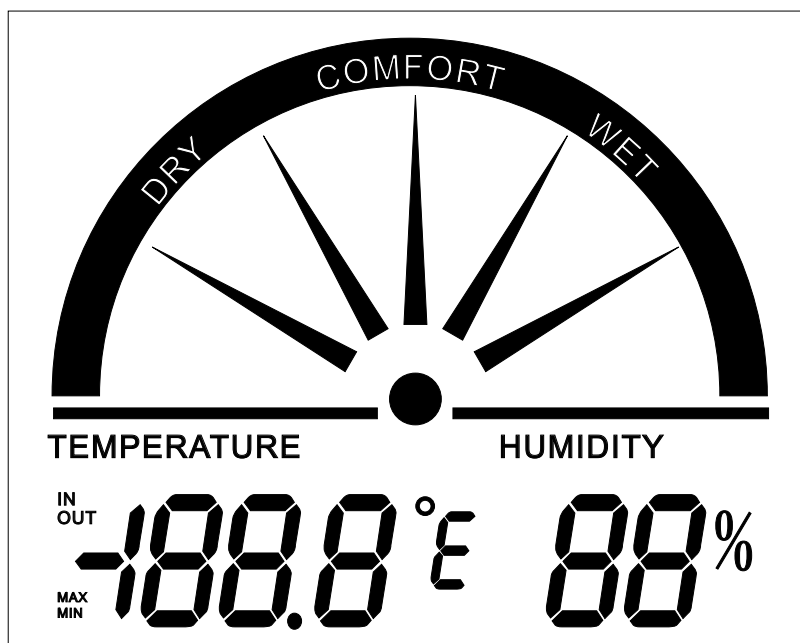

## 一) 按鍵操作

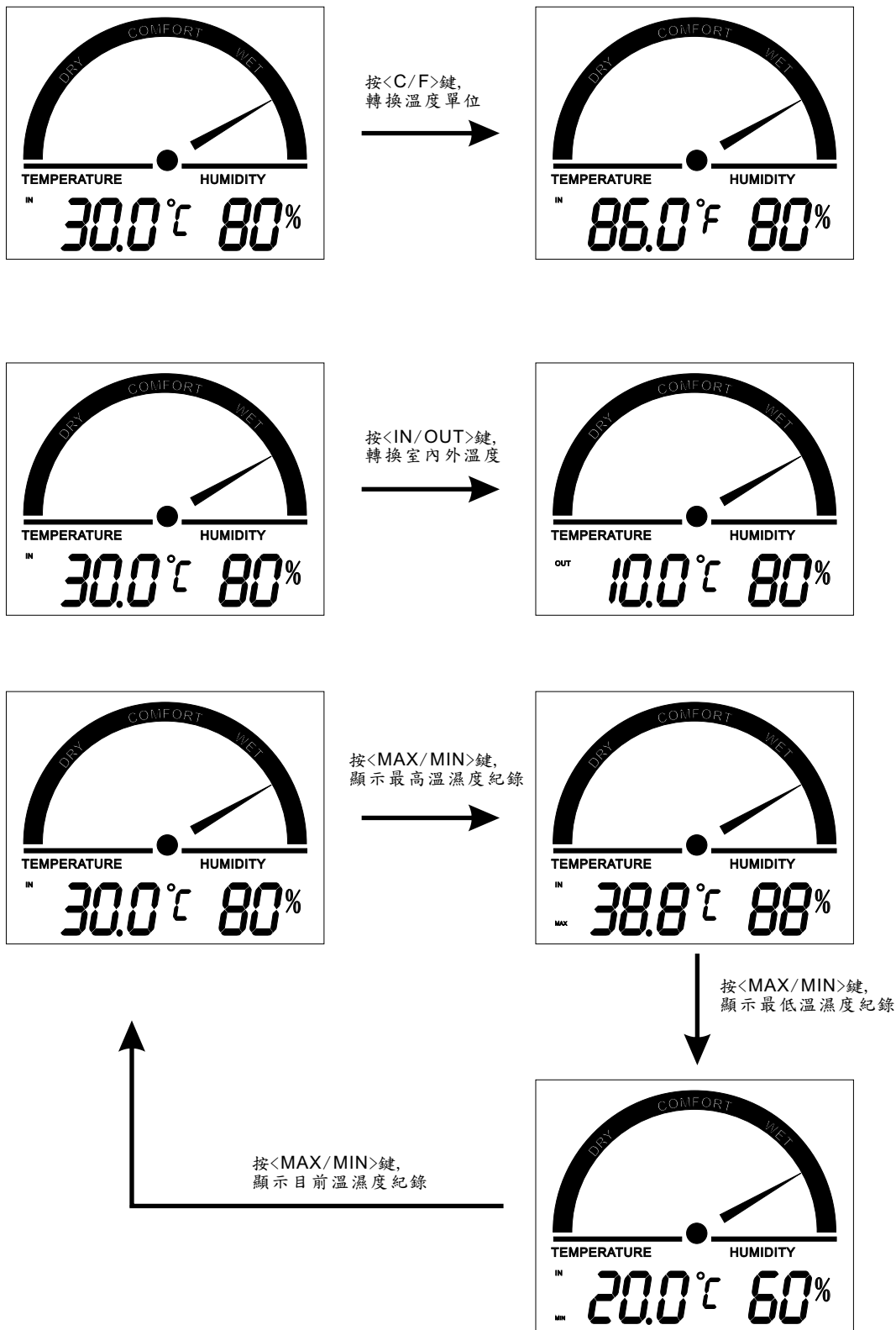

## 二) 五段濕度舒適度顯示

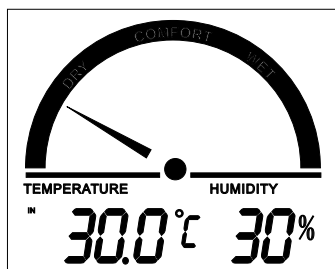

DRY: 濕度低於34%

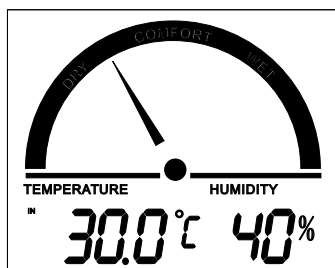

COMFORT/DRY: 濕度於35-40%

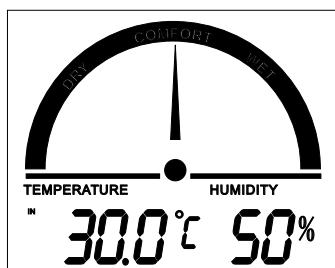

COMFORT/IDEAL: 濕度於41-55%

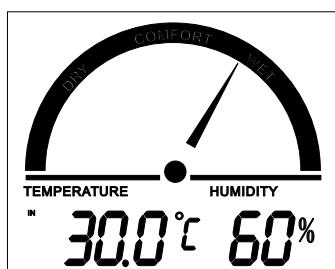

COMFORT/WET: 濕度於56-64%

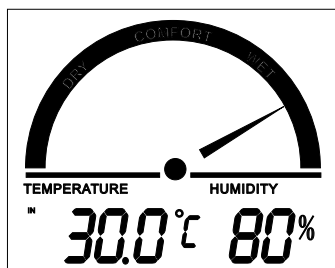

WET: 濕度高於65%

### 三) IC出脚图

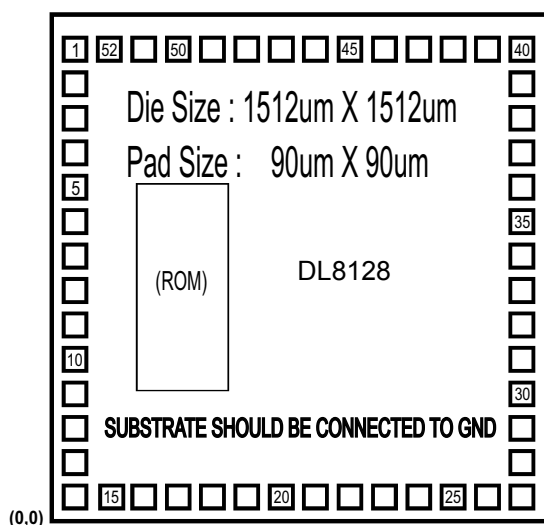

NO	NAME	X	Y	NO	NAME	X	Y
1	BAK	69.75	1422.25	27	SEG13	1442.25	69.75
2	XIN	69.75	1325.25	28	SEG14	1442.25	186.75
3	XOUT	69.75	1221.75	29	SEG15	1442.25	290.25
4	GND	69.75	1118.25	30	SEG16	1442.25	393.75
5	VDD1	69.75	1014.75	31	SEG17	1442.25	497.25
6	VDD2	69.75	911.25	32	SEG18	1442.25	600.75
7	VDD3	69.75	807.75	33	SEG19	1442.25	704.25
8	CUP1	69.75	704.25	34	SEG20	1442.25	807.75
9	CUP2	69.75	600.79	35	SEG21	1442.30	911.29
10	COM1	69.75	497.25	36	SEG22	1442.25	1014.75
11	COM2	69.75	393.75	37	SEG23	1442.25	1118.25
12	COM3	69.75	290.25	38	IOA1	1442.25	1221.75
13	COM4	69.75	186.75	39	IOA2	1442.25	1325.25
14	COM5	69.75	69.75	40	IOA3	1442.25	1442.25
15	SEG1	186.75	69.75	41	IOA4	1325.25	1442.25
16	SEG2	290.25	69.75	42	IOB1	1221.75	1442.20
17	SEG3	393.75	69.75	43	IOB2	1118.25	1442.25
18	SEG4	497.25	69.75	44	IOB3	1014.75	1442.25
19	SEG5	600.75	69.75	45	BZ	912.42	1441.89
20	SEG6	704.25	69.75	46	IOC1	807.75	1442.25
21	SEG7	807.75	69.75	47	IOC2	704.25	1442.25
22	SEG8	911.25	69.75	48	IOC3	600.75	1442.25
23	SEG9	1014.75	69.75	49	IOC4	497.25	1442.25
24	SEG10	1118.25	69.75	50	RESET	393.75	1442.25
25	SEG11	1221.75	69.75	51	INT	290.25	1442.25
26	SEG12	1325.25	69.75	52	N.C.	186.75	1442.25

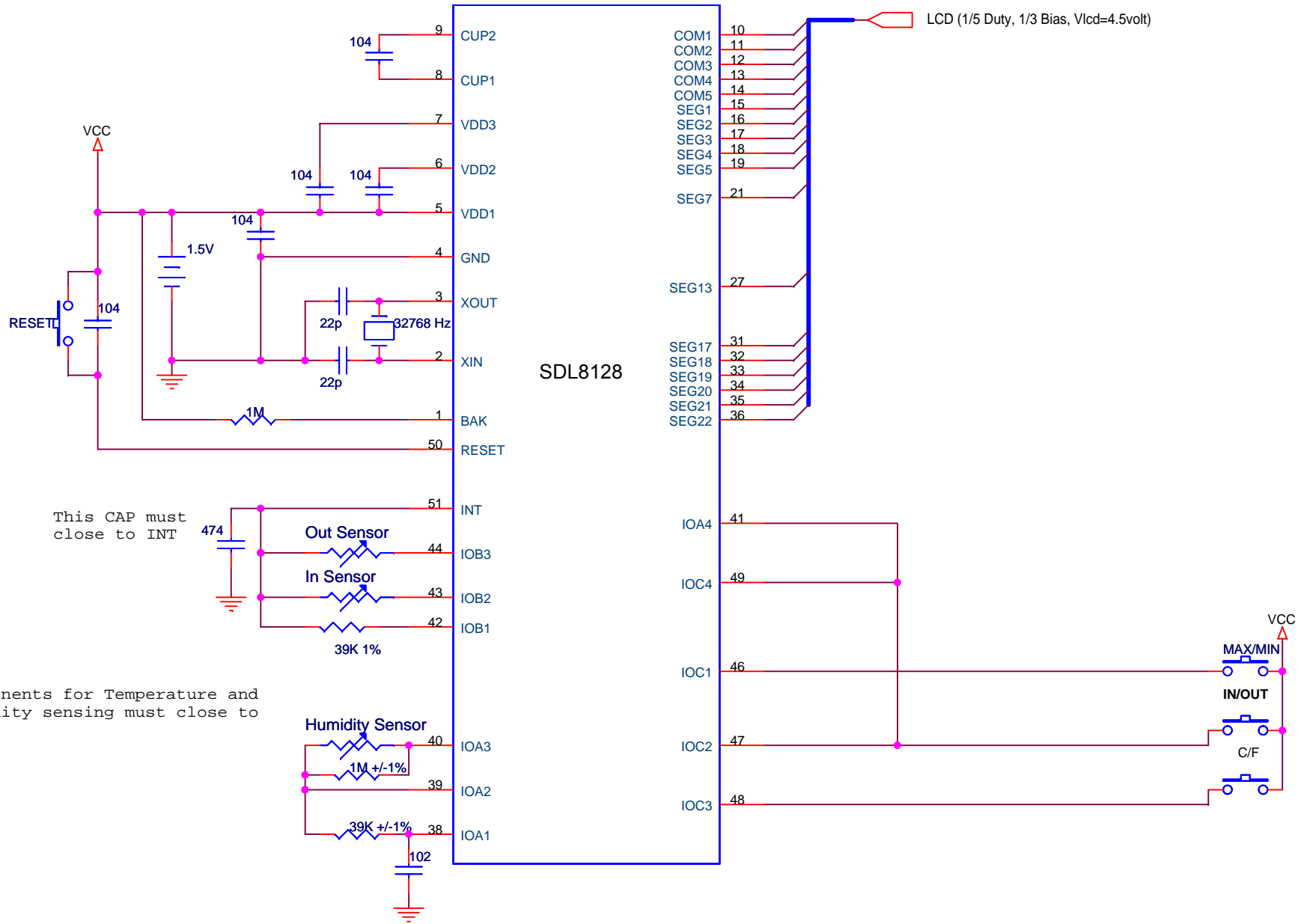

This CAP must close to INT

Components for Temperature and Humidity sensing must close to MCU

Title		
Size	Document Number	Rev
Date:	Tuesday, January 29, 2013	Sheet 1 of 3
		1.0

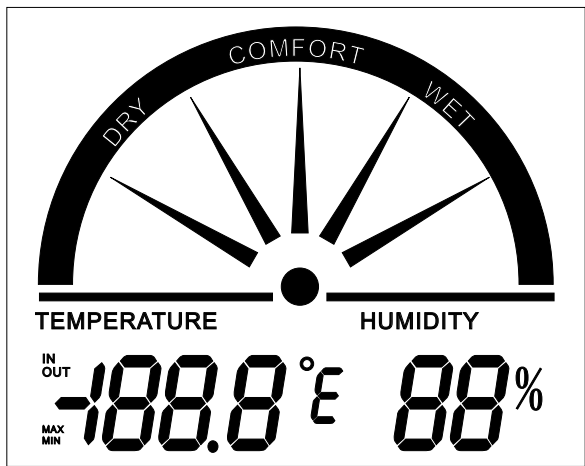

1/5 Duty, 1/3BIAS, Vlcd 4.5V

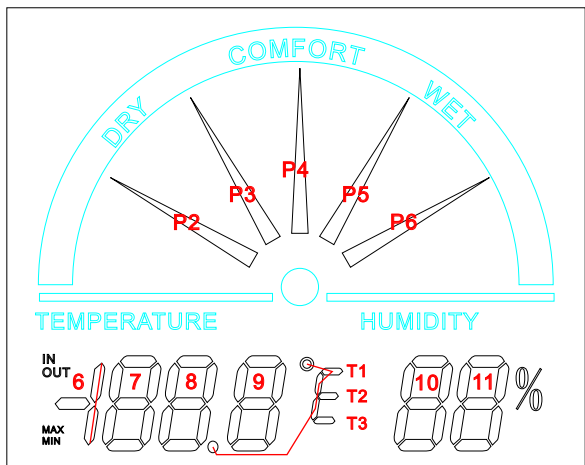

**Remark:**

藍色部分可作絲印或與S1點共作一點

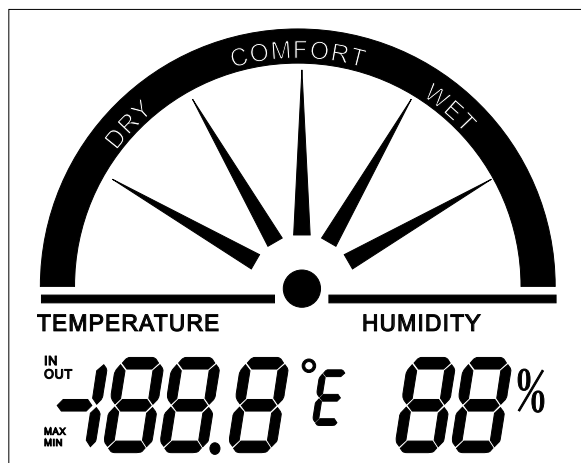

**1/5 Duty, 1/3BIAS, Vlcd 4.5V**

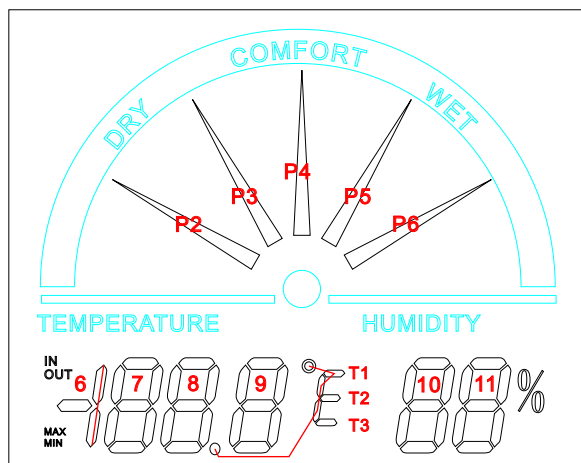

	SEG1	SEG2	SEG3	SEG4	SEG5	SEG6	SEG7	SEG8	SEG9	SEG10	SEG11
COM1		10D	11E	11D	P2						
COM2	10E	10C	11G	11C	P3						
COM3	10G	10B	11F	11B	P4						
COM4	10F	10A	%	11A	P5						
COM5		T3		T2	P6		T1				
	SEG12	SEG13	SEG14	SEG15	SEG16	SEG17	SEG18	SEG19	SEG20	SEG21	SEG22
COM1						9A	9F	8A	8F	7A	7F
COM2						9B	9G	8B	8G	7B	7G
COM3		OUT				9C	9E	8C	8E	7C	7E
COM4						9D		8D	MAX	7D	6BC
COM5						IN			MIN		6G

**Remark:**

藍色部分可作絲印或與S1點共作一點