



AH1

High Dynamic Range Amplifier

Product Features

- 250-3000 MHz Bandwidth
- 41 dBm Output IP3
- 2.8 dB Noise Figure
- 12 dB Gain
- 21 dBm P1dB
- High Reliability
- SOT-89 Surface Mount Package

Product Description

The AH1 is a high dynamic range amplifier packaged in a low cost surface mount package. The combination of low noise figure and high output IP3 at the same bias point makes it ideal for receiver and transmitter applications. The AH1 achieves +41 dBm IP3 at a mounting temperature of 85°C with an associated MTTF of >100 years. The package is a SOT-89. All devices are 100% RF & dc tested.

The product is targeted for applications where high linearity is required.

Functional Diagram

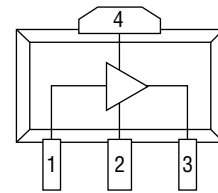

Function	Pin No.
Input	1
Ground	2
Output Bias	3
Ground	4

Specifications

Parameter	Units	Minimum	Typical	Maximum	Condition
Frequency Range	MHz		250-3000		
Gain	dB	12.4	13.5		
S11	dB		-8		
S22	dB		-15		
Output IP3	dBm	37	41		
Noise Figure	dB		2.7		
Output P1dB	dBm		21		
Operating Current Range	mA	120	150	180	Vdd = 5.0 V
Supply Voltage	V		5		

Test conditions unless otherwise noted.

1. T = 25°C, Vdd = 5.0, Freq = 800 MHz, 50 ohm system.

2. 3OIP Measured with two tones at an output power of 5 dBm/tone separated by 10 MHz. The suppression on the largest IM3 product is used to calculate the 3OIP using a 2:1 slope rule.

3. S21 and S11 can be improved in the band of interest using a single input shunt microstrip to ground.

4. Degradation of 3OIP occurs at low temperatures. Minimum typical 3OIP at -40°C is 35dBm.

5. MTTF calculated with channel temperature at 155°C and ground lead temperature at 85°C.

Absolute Maximum Ratings

Parameter	Rating
Operating Case Temperature	-40 to +85°C
Storage Temperature	-40 to +125 °C
Junction Temperature	+155°C
Supply Voltage	+6.0 V
Input RF Power	+15 dBm

Operation of this device above any of these parameters may cause permanent damage.

Ordering Information

Part No.	Description
AH1	Linear Amplifier, 500 pieces per reel
AH1-PCB	Fully assembled application circuit

Performance Charts ($V_{DS} = 5.0\text{ V}$, $I_{DS} = 150\text{ mA}$, $T = 22^\circ\text{C}$)

IP3 vs. Frequency

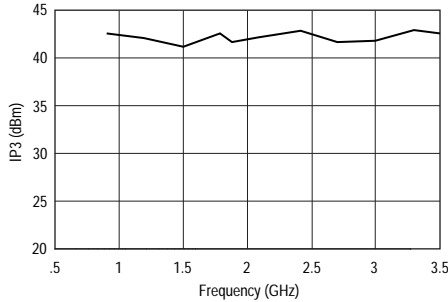

Gain vs. Frequency*

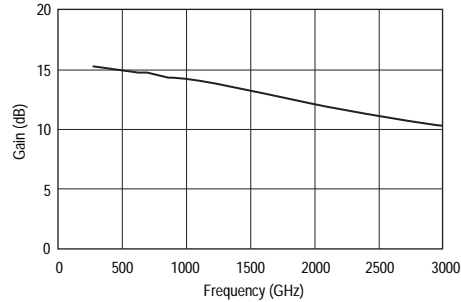

* without matching circuit

Input/Output Return Loss*

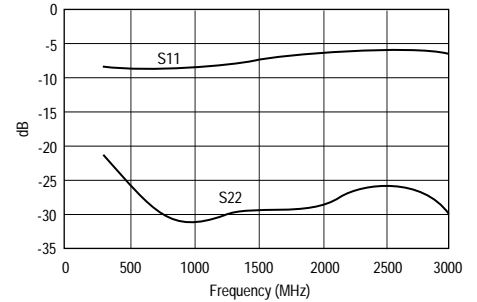

* without matching circuit

IP3 vs. Temperature

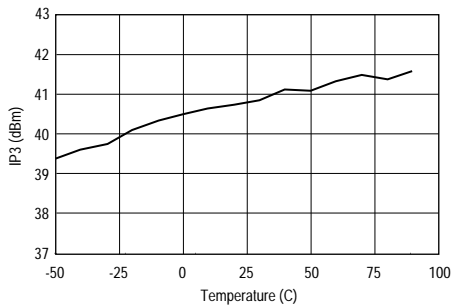

Gain vs. Temperature

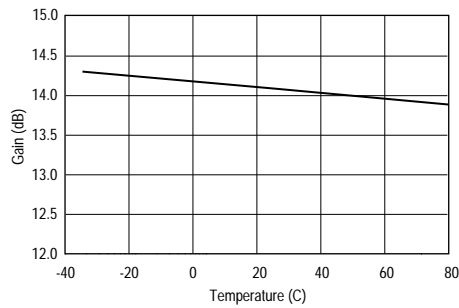

IP3 Pull Circles

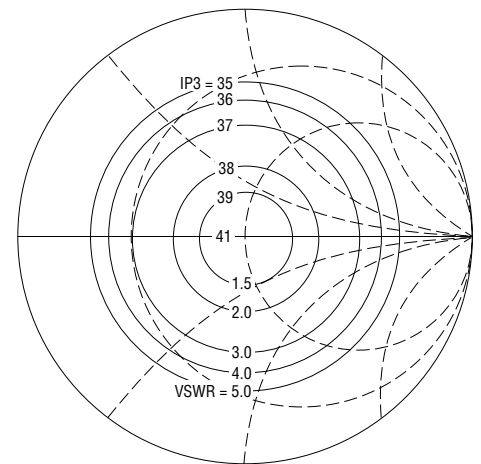

Frequency = 900 MHz
Vds = 5.0 V, 100% Idss, T = 22°C

Gain vs. Power Out

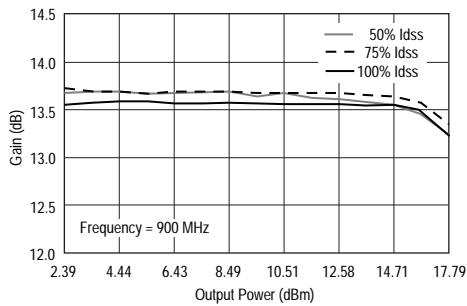

Output IP3 vs. Power Out

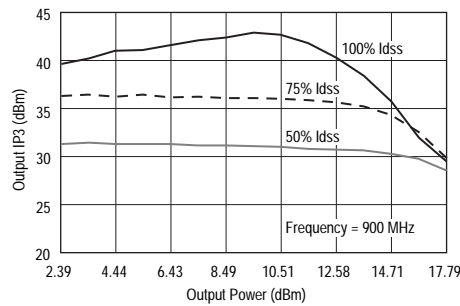

MTTF vs. Temperature

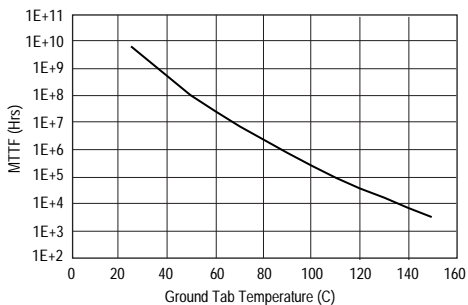

AH1

Application Circuit: 0.9-2.5 GHz

Typical Performance

Frequency	0.9 GHz	1.9 GHz	2.4 GHz
Magnitude S21	14.2 dB	12.4 dB	11.7 dB
Magnitude S11	-18.5 dB	-12.9 dB	-13.6 dB
Magnitude S22	-14.7 dB	-12.6 dB	-11.0 dB
IP3	39.0 dBm	41.0 dBm	40 dBm
Noise Figure	2.7 dB	3.4 dB	3.7 dB
Bias	Vd = 5 V, Id = 170 mA		

S-Parameters

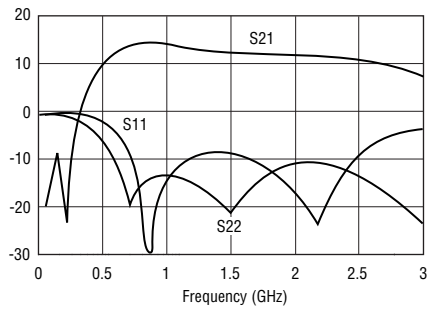

Schematic

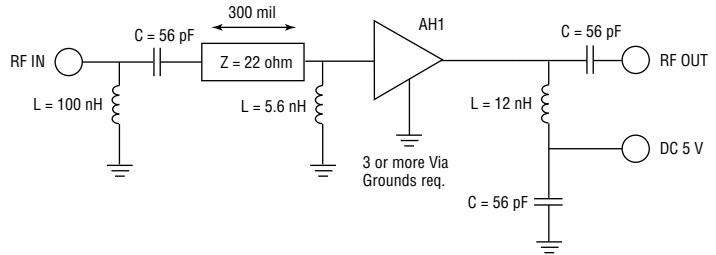

FR4 Board Layout (T = 14 Mil)

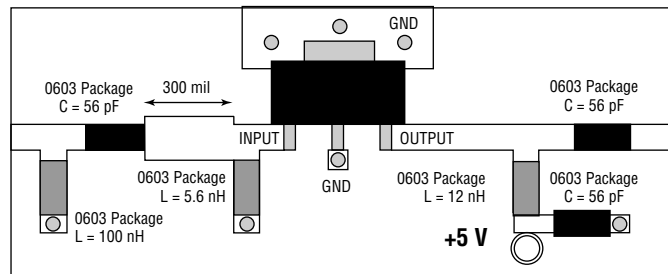

Outline Drawing: SOT-89

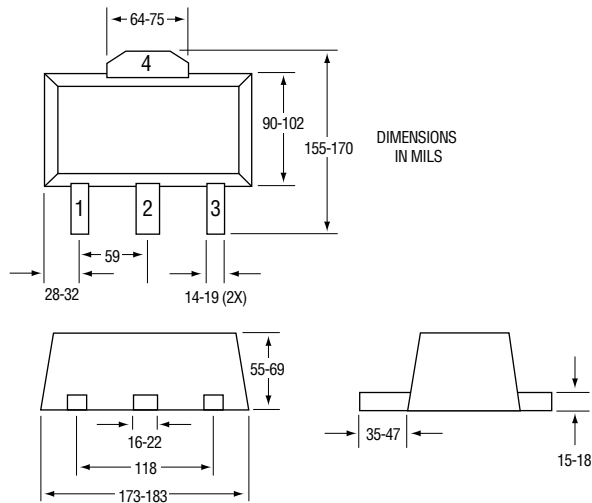

Land Pattern

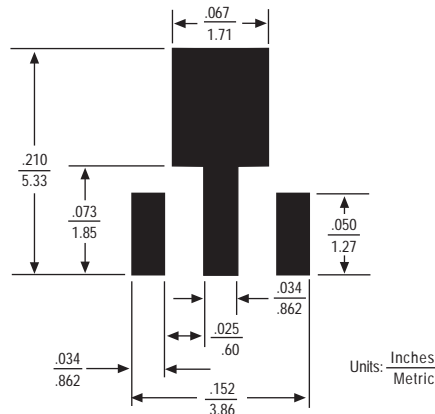

Typical Automatic Test Data

S-Parameters ($I_{DS} = 150 \text{ mA}$, $V_{DS} = +5 \text{ V}$, $T = 22^\circ\text{C}$, $Z = 50 \text{ ohms}$)

Freq (MHz)	S11 Mag	S11 Ang	S21 (dB)	S21 Mag	S21 Ang	S12 Mag	S12 Ang	S22 Mag	S22 Ang	K Value
300	0.385	-46.990	15.181	5.742	157.037	0.087	3.964	0.089	-66.530	1.062
400	0.374	-53.376	15.015	5.633	152.400	0.087	-0.428	0.070	-70.095	1.090
500	0.373	-60.650	14.908	5.564	147.518	0.088	-3.847	0.055	-69.277	1.103
600	0.373	-68.718	14.788	5.488	142.410	0.088	-6.806	0.043	-75.238	1.116
700	0.376	-76.746	14.663	5.409	137.282	0.088	-9.585	0.036	-80.347	1.128
800	0.380	-84.449	14.507	5.313	132.011	0.088	-12.184	0.031	-88.416	1.139
900	0.383	-92.673	14.318	5.199	126.442	0.087	-14.643	0.028	-102.961	1.154
1000	0.388	-101.021	14.220	5.141	121.353	0.087	-17.006	0.029	-115.173	1.159
1100	0.394	-109.189	14.069	5.052	116.267	0.087	-19.432	0.029	-127.412	1.168
1200	0.403	-116.975	13.896	4.952	111.154	0.087	-21.689	0.031	-124.686	1.176
1300	0.413	-124.433	13.698	4.841	106.042	0.086	-24.093	0.033	-90.875	1.185
1400	0.425	-131.566	13.487	4.724	101.024	0.086	-26.335	0.035	-93.847	1.198
1500	0.438	-138.169	13.273	4.609	96.109	0.085	-28.545	0.034	-94.192	1.210
1600	0.450	-144.356	13.045	4.490	91.324	0.084	-30.630	0.035	-91.925	1.224
1700	0.463	-149.987	12.811	4.371	86.560	0.084	-32.708	0.035	-138.791	1.241
1800	0.477	-155.154	12.577	4.254	81.996	0.083	-34.679	0.035	-131.588	1.253
1900	0.489	-160.003	12.337	4.139	77.549	0.082	-36.681	0.036	-120.952	1.272
2000	0.500	-164.309	12.106	4.030	73.226	0.081	-38.358	0.039	-112.026	1.289
2100	0.509	-168.120	11.885	3.929	69.032	0.081	-40.127	0.042	-104.837	1.306
2200	0.517	-171.726	11.677	3.836	64.905	0.080	-41.728	0.046	-99.684	1.322
2300	0.523	-175.359	11.478	3.749	60.845	0.079	-43.332	0.049	-94.737	1.344
2400	0.527	-9.058	11.287	3.667	56.754	0.079	-44.949	0.052	-92.048	1.366
2500	0.528	176.218	11.125	3.600	52.689	0.078	-46.419	0.053	-90.189	1.389
2600	0.526	173.376	10.972	3.537	48.710	0.078	-48.000	0.052	-88.680	1.418
2700	0.523	169.003	10.823	3.477	44.647	0.078	-49.738	0.050	-87.931	1.450
2800	0.518	164.088	10.684	3.422	40.452	0.077	-51.479	0.048	-88.079	1.486
2900	0.513	158.780	10.543	3.366	36.157	0.077	-53.246	0.042	-87.362	1.526
3000	0.510	153.067	10.400	3.311	31.816	0.077	-55.207	0.034	-82.552	1.561

Specifications and information are subject to change without notice.



Caution! ESD sensitive device.

SUNSTAR 商斯达实业集团是集研发、生产、工程、销售、代理经销、技术咨询、信息服务等为一体的高科技企业，是专业高科技电子产品生产厂家，是具有 10 多年历史的专业电子元器件供应商，是中国最早和最大的仓储式连锁规模经营大型综合电子零部件代理分销商之一，是一家专业代理和分销世界各大品牌 IC 芯片和电子元器件的连锁经营综合性国际公司，专业经营进口、国产名厂名牌电子元件，型号、种类齐全。在香港、北京、深圳、上海、西安、成都等全国主要电子市场设有直属分公司和产品展示展销窗口门市部专卖店及代理分销商，已在全国范围内建成强大统一的供货和代理分销网络。我们专业代理经销、开发生产电子元器件、集成电路、传感器、微波光电元器件、工控机/DOC/DOM 电子盘、专用电路、单片机开发、MCU/DSP/ARM/FPGA 软件硬件、二极管、三极管、模块等，是您可靠的一站式现货配套供应商、方案提供商、部件功能模块开发配套商。商斯达实业公司拥有庞大的资料库，有数位毕业于著名高校——有中国电子工业摇篮之称的西安电子科技大学（西军电）并长期从事国防尖端科技研究的高级工程师为您精挑细选、量身订做各种高科技电子元器件，并解决各种技术问题。

微波光电部专业代理经销高频、微波、光纤、光电元器件、组件、部件、模块、整机；电磁兼容元器件、材料、设备；微波 CAD、EDA 软件、开发测试仿真工具；微波、光纤仪器仪表。欢迎国外高科技微波、光纤厂商将优秀产品介绍到中国、共同开拓市场。长期大量现货专业批发高频、微波、卫星、光纤、电视、CATV 器件：晶振、VCO、连接器、PIN 开关、变容二极管、开关二极管、低噪晶体管、功率电阻及电容、放大器、功率管、MMIC、混频器、耦合器、功分器、振荡器、合成器、衰减器、滤波器、隔离器、环行器、移相器、调制解调器；光电子器件和组件：红外发射管、红外接收管、光电开关、光敏管、发光二极管和发光二极管组件、半导体激光二极管和激光器组件、光电探测器和光接收组件、光发射接收模块、光纤激光器和光放大器、光调制器、光开关、DWDM 用光发射和接收器件、用户接入系统光收发器件与模块、光纤连接器、光纤跳线/尾纤、光衰减器、光纤适配器、光隔离器、光耦合器、光环行器、光复用器/转换器；无线收发芯片和模组、蓝牙芯片和模组。

更多产品请看本公司产品专用销售网站：

商斯达中国传感器科技信息网：<http://www.sensor-ic.com/>

商斯达工控安防网：<http://www.pc-ps.net/>

商斯达电子元器件网：<http://www.sunstare.com/>

商斯达微波光电产品网：[HTTP://www.rfoe.net/](http://www.rfoe.net/)

商斯达消费电子产品网：<http://www.icasic.com/>

商斯达实业科技产品网：<http://www.sunstars.cn/> 微波元器件销售热线：

地址：深圳市福田区福华路福庆街鸿图大厦 1602 室

电话：0755-82884100 83397033 83396822 83398585

传真：0755-83376182 (0) 13823648918 MSN: SUNS8888@hotmail.com

邮编：518033 E-mail:szss20@163.com QQ: 195847376

深圳赛格展销部：深圳华强北路赛格电子市场 2583 号 电话：0755-83665529 25059422

技术支持：0755-83394033 13501568376

欢迎索取免费详细资料、设计指南和光盘；产品凡多，未能尽录，欢迎来电查询。

北京分公司：北京海淀区知春路 132 号中发电子大厦 3097 号

TEL: 010-81159046 82615020 13501189838 FAX: 010-62543996

上海分公司：上海市北京东路 668 号上海赛格电子市场 D125 号

TEL: 021-28311762 56703037 13701955389 FAX: 021-56703037

西安分公司：西安高新开发区 20 所(中国电子科技集团导航技术研究所)

西安劳动南路 88 号电子商城二楼 D23 号

TEL: 029-81022619 13072977981 FAX:029-88789382