

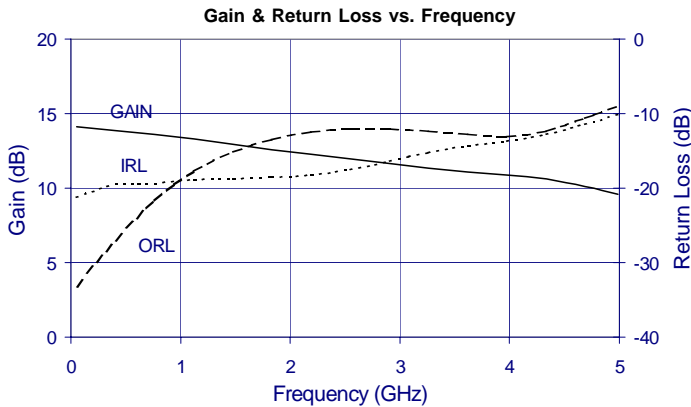

Product Description

The SGA-6289 is a high performance SiGe HBT MMIC Amplifier. A Darlington configuration featuring 1 micron emitters provides high F_T and excellent thermal performance. The heterojunction increases breakdown voltage and minimizes leakage current between junctions. Cancellation of emitter junction non-linearities results in higher suppression of intermodulation products. Only 2 DC-blocking capacitors, a bias resistor and an optional RF choke are required for operation.

The matte tin finish on Sirenza's lead-free package utilizes a post annealing process to mitigate tin whisker formation and is RoHS compliant per EU Directive 2002/95. This package is also manufactured with green molding compounds that contain no antimony trioxide nor halogenated fire retardants.



SGA-6289

SGA-6289Z RoHS Compliant & Green Package

DC-4500 MHz, Cascadable SiGe HBT MMIC Amplifier



Product Features

- Now available in Lead Free, RoHS Compliant, & Green Packaging
- Broadband Operation: DC-4500 MHz
- Cascadable 50 Ohm
- Operates From Single Supply
- Low Thermal Resistance Package

Applications

- PA Driver Amplifier
- Cellular, PCS, GSM, UMTS
- IF Amplifier
- Wireless Data, Satellite

Symbol	Parameter	Units	Frequency	Min.	Typ.	Max.
G	Small Signal Gain	dB	850 MHz 1950 MHz 2400 MHz	12.3	13.9 12.6 12.2	15.1
P_{1dB}	Output Power at 1dB Compression	dBm	850 MHz 1950 MHz		18.1 17.8	
OIP_3	Output Third Order Intercept Point	dBm	850 MHz 1950 MHz		34.4 32.0	
Bandwidth	Determined by Return Loss (>10dB)	MHz			4500	
IRL	Input Return Loss	dB	1950 MHz		18.5	
ORL	Output Return Loss	dB	1950 MHz		13.1	
NF	Noise Figure	dB	1950 MHz		4.0	
V_D	Device Operating Voltage	V		3.6	4.0	4.4
I_D	Device Operating Current	mA		67	75	83
R_{TH} , j-l	Thermal Resistance (junction to lead)	$^{\circ}C/W$			97	

Test Conditions: $V_S = 8 V$, $I_D = 75 mA$ Typ., OIP_3 Tone Spacing = 1 MHz, P_{out} per tone = 0 dBm
 $R_{BIAS} = 51 Ohms$, $T_L = 25^{\circ}C$, $Z_S = Z_L = 50 Ohms$

The information provided herein is believed to be reliable at press time. Sirenza Microdevices assumes no responsibility for inaccuracies or omissions. Sirenza Microdevices assumes no responsibility for the use of this information, and all such information shall be entirely at the user's own risk. Prices and specifications are subject to change without notice. No patent rights or licenses to any of the circuits described herein are implied or granted to any third party. Sirenza Microdevices does not authorize or warrant any Sirenza Microdevices product for use in life-support devices and/or systems. Copyright 2001 Sirenza Microdevices, Inc.. All worldwide rights reserved.



SGA-6289 DC-4500 MHz Cascadable MMIC Amplifier

Typical RF Performance at Key Operating Frequencies

Symbol	Parameter	Unit	Frequency (MHz)					
			100	500	850	1950	2400	3500
G	Small Signal Gain	dB	13.5	14.0	13.9	12.6	12.2	10.6
OIP ₃	Output Third Order Intercept Point	dBm	36.0	35.0	34.4	32.0	31.2	28.2
P _{1dB}	Output Power at 1dB Compression	dBm	18.7	18.6	18.1	17.8	17.1	15.6
IRL	Input Return Loss	dB	20.8	19.5	19.3	18.5	17.9	14.7
ORL	Output Return Loss	dB	32.8	25.6	20.6	13.1	12.2	12.6
S ₁₂	Reverse Isolation	dB	17.4	18.6	18.9	19.2	19.1	18.1
NF	Noise Figure	dB	3.9	3.8	3.7	4.0	4.6	5.1

Test Conditions: V_S = 8 V, I_D = 75 mA Typ., OIP₃ Tone Spacing = 1 MHz, P_{out} per tone = 0 dBm
R_{BIAS} = 51 Ohms, T_L = 25°C, Z_S = Z_L = 50 Ohms

Noise Figure vs. Frequency
V_D = 4.0 V, I_D = 75 mA

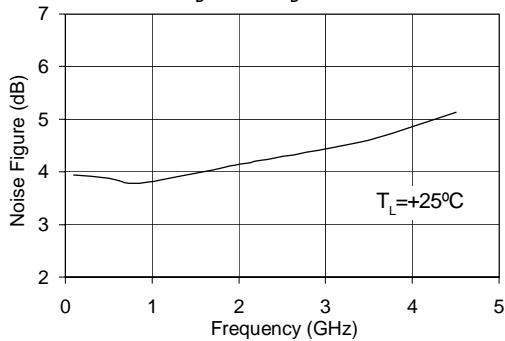

Absolute Maximum Ratings

Parameter	Absolute Limit
Max. Device Current (I _D)	150 mA
Max. Device Voltage (V _D)	6 V
Max. RF Input Power	+18 dBm
Max. Junction Temp. (T _J)	+150°C
Operating Temp. Range (T _L)	-40°C to +85°C
Max. Storage Temp.	+150°C

Operation of this device beyond any one of these limits may cause permanent damage. For reliable continuous operation, the device voltage and current must not exceed the maximum operating values specified in the table on page one.

Bias Conditions should also satisfy the following expression:
 $I_D V_D < (T_J - T_L) / R_{TH} \cdot I$

Take into account out of band VSWR presented by devices such as SAW filters to determine maximum RF input power. Reflected harmonic levels in saturation are significant.

OIP₃ vs. Frequency
V_D = 4.0 V, I_D = 75 mA

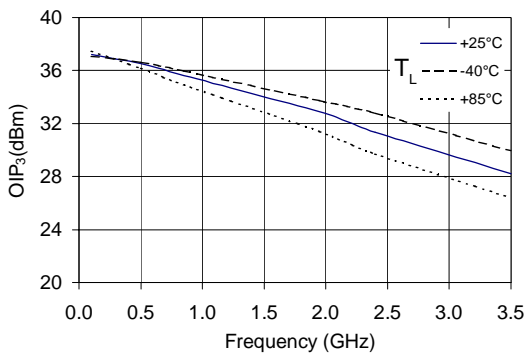

P_{1dB} vs. Frequency
V_D = 4.0 V, I_D = 75 mA

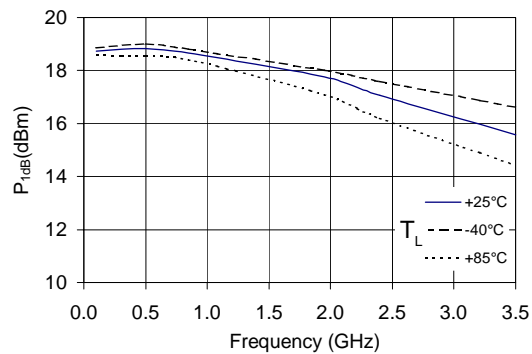



SGA-6289 DC-4500 MHz Cascadable MMIC Amplifier

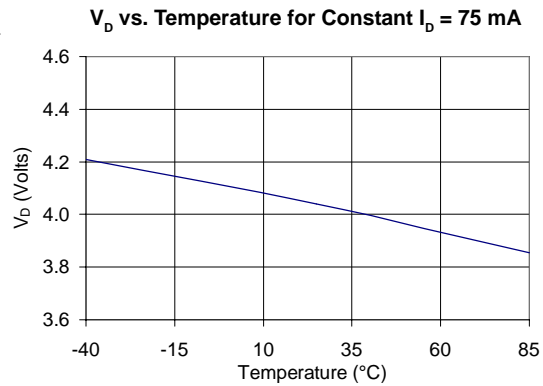
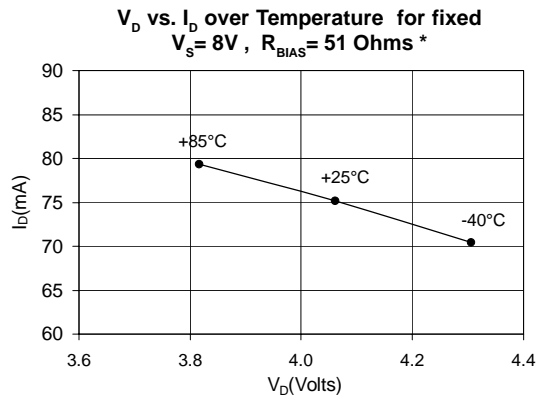
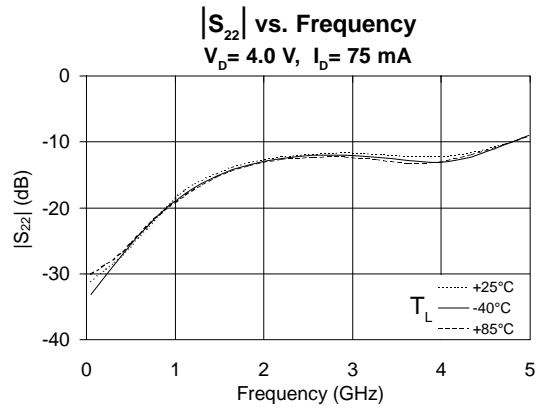
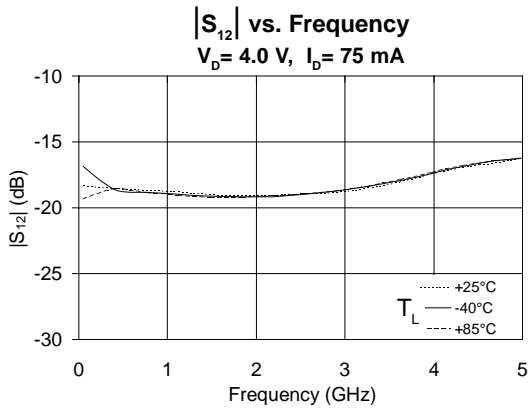
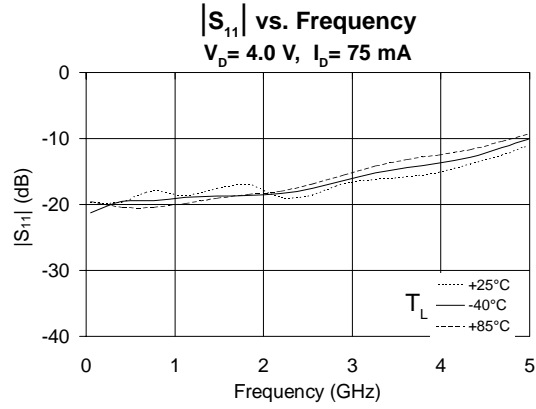
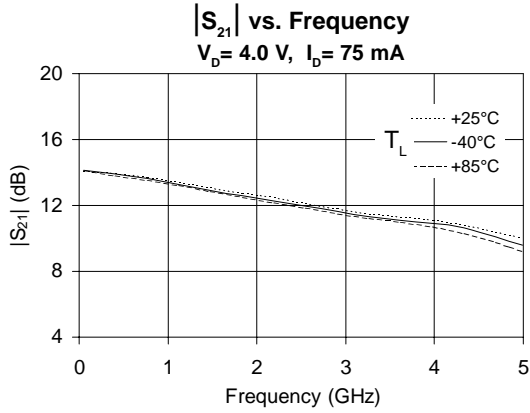

* Note: In the applications circuit on page 4, R_{BIAS} compensates for voltage and current variation over temperature.



SGA-6289 DC-4500 MHz Cascadable MMIC Amplifier

Basic Application Circuit

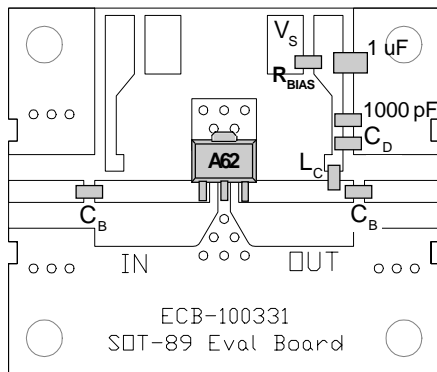
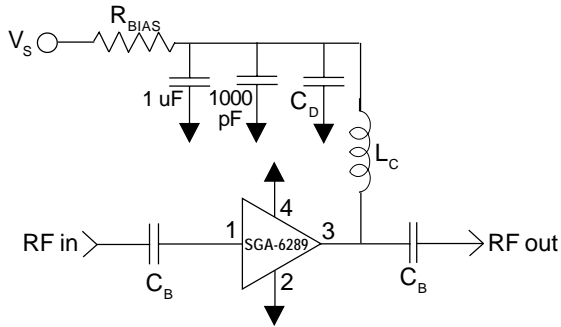

Part Identification Marking

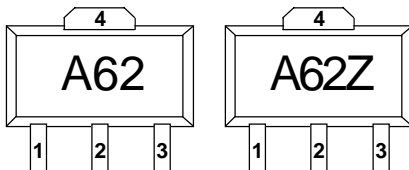

Caution: ESD sensitive
Appropriate precautions in handling, packaging and testing devices must be observed.

**See Application Note AN-075
for Package Outline Drawing**

Application Circuit Element Values

Reference Designator	Frequency (Mhz)				
	500	850	1950	2400	3500
C _B	220 pF	100 pF	68 pF	56 pF	39 pF
C _D	100 pF	68 pF	22 pF	22 pF	15 pF
L _C	68 nH	33 nH	22 nH	18 nH	15 nH

Recommended Bias Resistor Values for I_D=75mA
 $R_{BIAS} = (V_S - V_D) / I_D$

Supply Voltage(V _S)	6 V	8 V	10 V	12 V
R _{BIAS}	27 Ω	51 Ω	82 Ω	110 Ω

Note: R_{BIAS} provides DC bias stability over temperature.

Mounting Instructions

- Solder the copper pad on the backside of the device package to the ground plane.
- Use a large ground pad area with many plated through-holes as shown.
- We recommend 1 or 2 ounce copper. Measurements for this data sheet were made on a 31 mil thick FR-4 board with 1 ounce copper on both sides.

Pin #	Function	Description
1	RF IN	RF input pin. This pin requires the use of an external DC blocking capacitor chosen for the frequency of operation.
2, 4	GND	Connection to ground. For optimum RF performance, use via holes as close to ground leads as possible to reduce lead inductance.
3	RF OUT/ BIAS	RF output and bias pin. DC voltage is present on this pin, therefore a DC blocking capacitor is necessary for proper operation.

Part Number Ordering Information

Part Number	Reel Size	Devices/Reel
SGA-6289	13"	3000
SGA-6289Z	13"	3000

SUNSTAR 商斯达实业集团是集研发、生产、工程、销售、代理经销、技术咨询、信息服务等为一体的高科技企业，是专业高科技电子产品生产厂家，是具有 10 多年历史的专业电子元器件供应商，是中国最早和最大的仓储式连锁规模经营大型综合电子零部件代理分销商之一，是一家专业代理和分销世界各大品牌 IC 芯片和电子元器件的连锁经营综合性国际公司，专业经营进口、国产名厂名牌电子元件，型号、种类齐全。在香港、北京、深圳、上海、西安、成都等全国主要电子市场设有直属分公司和产品展示展销窗口门市部专卖店及代理分销商，已在全国范围内建成强大统一的供货和代理分销网络。我们专业代理经销、开发生产电子元器件、集成电路、传感器、微波光电元器件、工控机/DOC/DOM 电子盘、专用电路、单片机开发、MCU/DSP/ARM/FPGA 软件硬件、二极管、三极管、模块等，是您可靠的一站式现货配套供应商、方案提供商、部件功能模块开发配套商。商斯达实业公司拥有庞大的资料库，有数位毕业于著名高校——有中国电子工业摇篮之称的西安电子科技大学（西军电）并长期从事国防尖端科技研究的高级工程师为您精挑细选、量身订做各种高科技电子元器件，并解决各种技术问题。

微波光电部专业代理经销高频、微波、光纤、光电元器件、组件、部件、模块、整机；电磁兼容元器件、材料、设备；微波 CAD、EDA 软件、开发测试仿真工具；微波、光纤仪器仪表。欢迎国外高科技微波、光纤厂商将优秀产品介绍到中国、共同开拓市场。长期大量现货专业批发高频、微波、卫星、光纤、电视、CATV 器件：晶振、VCO、连接器、PIN 开关、变容二极管、开关二极管、低噪晶体管、功率电阻及电容、放大器、功率管、MMIC、混频器、耦合器、功分器、振荡器、合成器、衰减器、滤波器、隔离器、环行器、移相器、调制解调器；光电子元件和组件：红外发射管、红外接收管、光电开关、光敏管、发光二极管和发光二极管组件、半导体激光二极管和激光器组件、光电探测器和光接收组件、光发射接收模块、光纤激光器和光放大器、光调制器、光开关、DWDM 用光发射和接收器件、用户接入系统光收发器件与模块、光纤连接器、光纤跳线/尾纤、光衰减器、光纤适配器、光隔离器、光耦合器、光环行器、光复用器/转换器；无线收发芯片和模组、蓝牙芯片和模组。

更多产品请看本公司产品专用销售网站：

商斯达中国传感器科技信息网：<http://www.sensor-ic.com/>

商斯达工控安防网：<http://www.pc-ps.net/>

商斯达电子元器件网：<http://www.sunstare.com/>

商斯达微波光电产品网：[HTTP://www.rfoe.net/](http://www.rfoe.net/)

商斯达消费电子产品网：<http://www.icasic.com/>

商斯达实业科技产品网：<http://www.sunstars.cn/> 微波元器件销售热线：

地址：深圳市福田区福华路福庆街鸿图大厦 1602 室

电话：0755-82884100 83397033 83396822 83398585

传真：0755-83376182 (0) 13823648918 MSN: SUNS8888@hotmail.com

邮编：518033 E-mail:szss20@163.com QQ: 195847376

深圳赛格展销部：深圳华强北路赛格电子市场 2583 号 电话：0755-83665529 25059422

技术支持：0755-83394033 13501568376

欢迎索取免费详细资料、设计指南和光盘；产品凡多，未能尽录，欢迎来电查询。

北京分公司：北京海淀区知春路 132 号中发电子大厦 3097 号

TEL: 010-81159046 82615020 13501189838 FAX: 010-62543996

上海分公司：上海市北京东路 668 号上海赛格电子市场 D125 号

TEL: 021-28311762 56703037 13701955389 FAX: 021-56703037

西安分公司：西安高新开发区 20 所(中国电子科技集团导航技术研究所)

西安劳动南路 88 号电子商城二楼 D23 号

TEL: 029-81022619 13072977981 FAX:029-88789382