

Product Description

Sirenza Microdevices' SNA-600 is a high-performance GaAs Heterojunction Bipolar Transistor (MMIC) in die form. A Darlington configuration is utilized for broadband performance to 6.5 GHz.

These unconditionally stable amplifiers provide 11dB of gain and +18dBm of P1dB when biased at 65mA.

This MMIC requires only a single supply voltage. The use of an external resistor allows for bias flexibility and stability. Its small size (0.4mm x 0.4mm) and gold metallization make it an ideal choice for use in hybrid circuits.

The SNA-600 is available in gel paks at 100 devices per container. Also available in packaged form (SNA-676 & SNA-686).

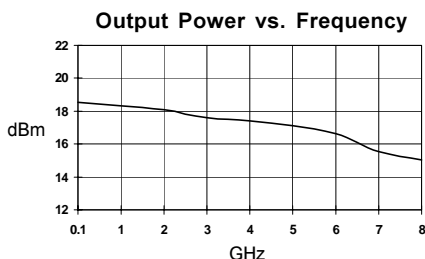

SNA-600

DC-6.5 GHz, Cascadable GaAs MMIC Amplifier

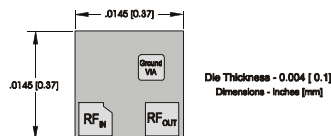

Product Features

- Cascadable 50 Ohm Gain Block
- 11dB Gain, +18dBm P1dB
- High Linearity, +36dBm TOIP Typ.
- 1.5:1 Input and Output VSWR
- Chip Back Is Ground

Applications

- PA Driver Amplifier
- Cellular, PCS, GSM, UMTS
- IF Amplifier
- Wireless Data, Satellite

Symbol	Parameter	Frequency	Units	Min.	Typ.	Max.
P _{1dB}	Output Power at 1dB Compression	850 MHz	dBm		17.6	
		1950 MHz	dBm		17.7	
		2400 MHz	dBm		17.4	
IP ₃	Third Order Intercept Point	850 MHz	dBm		34.0	
		1950 MHz	dBm		32.1	
		2400 MHz	dBm		30.0	
S ₂₁	Small Signal Gain	850 MHz	dB		11.1	
		1950 MHz	dB		11.2	
		2400 MHz	dB		11.3	
Bandwidth	(Determined by S ₁₁ , S ₂₂ Values)		MHz		6000	
VSWR _{IN}	Input VSWR	DC-6000 MHz	-		1.3:1	
VSWR _{OUT}	Output VSWR	DC-6000 MHz	-		1.4:1	
S ₁₂	Reverse Isolation	850 MHz	dB		16.3	
		1950 MHz	dB		16.5	
		2400 MHz	dB		16.6	
NF	Noise Figure	1950 MHz	dB		7.3	
V _D	Device Operating Voltage		V	4.8	5.3	5.8
I _D	Device Operating Current		mA	58	65	72
R _{TH} j-b	Thermal Resistance (junction -backside)		° C/W		200	

Test Conditions:

$$V_S = 8 \text{ V}$$

$$R_{BIAS} = 43 \text{ Ohms}$$

$$I_D = 65 \text{ mA Typ.}$$

$$T_L = 25^\circ\text{C}$$

$$OIP_3 \text{ Tone Spacing} = 1 \text{ MHz, } P_{out} \text{ per tone} = 0 \text{ dBm}$$

$$Z_S = Z_L = 50 \text{ Ohms}$$

The information provided herein is believed to be reliable at press time. Sirenza Microdevices assumes no responsibility for inaccuracies or omissions. Sirenza Microdevices assumes no responsibility for the use of this information, and all such information shall be entirely at the user's own risk. Prices and specifications are subject to change without notice. No patent rights or licenses to any of the circuits described herein are implied or granted to any third party. Sirenza Microdevices does not authorize or warrant any Sirenza Microdevices product for use in life-support devices and/or systems. Copyright 2001 Sirenza Microdevices, Inc. All worldwide rights reserved. <http://www.rfoe.net/> TEL:0755-83397033 FAX:0755-83376182 E-MAIL:szss20@163.com

SNA-600 DC-6.5 GHz Cascadable MMIC Amplifier

Typical Performance at 25 °C ($V_{ds} = 5.3V, I_{ds} = 65mA$)

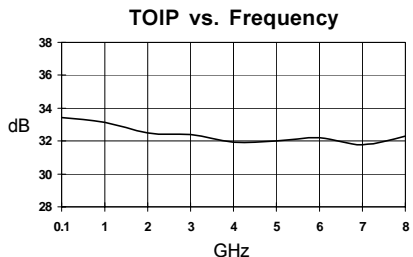
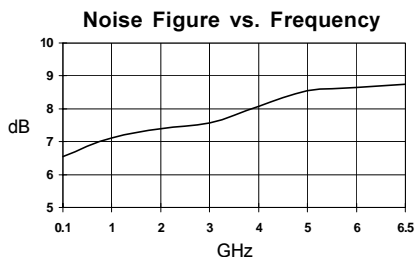
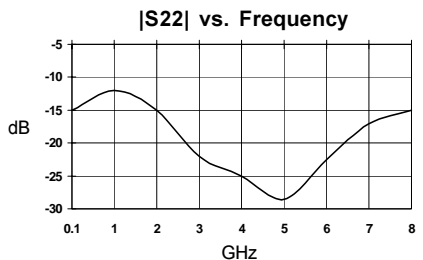
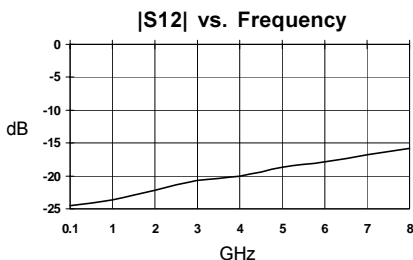
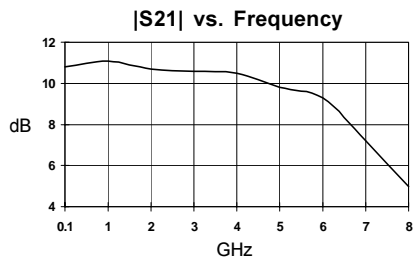
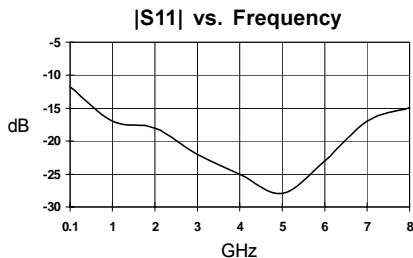

Absolute Maximum Ratings

Parameter	Absolute Limit
Max. Device Current (I_D)	150 mA
Max. Device Voltage (V_D)	7 V
Max. RF Input Power	+23 dBm
Max. Junction Temp. (T_J)	+200°C
Operating Temp. Range (T_L)	-40°C to +85°C
Max. Storage Temp.	+150°C

Operation of this device beyond any one of these limits may cause permanent damage. For reliable continuous operation, the device voltage and current must not exceed the maximum operating values specified in the table on page one.

Bias Conditions should also satisfy the following expression:

$$I_D V_D < (T_J - T_L) / R_{TH} \text{ j-I}$$

SNA-600 DC-6.5 GHz Cascadable MMIC Amplifier

Typical Application Circuit

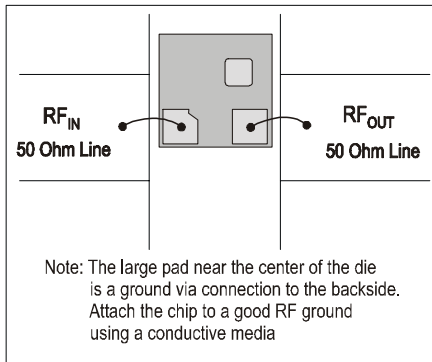
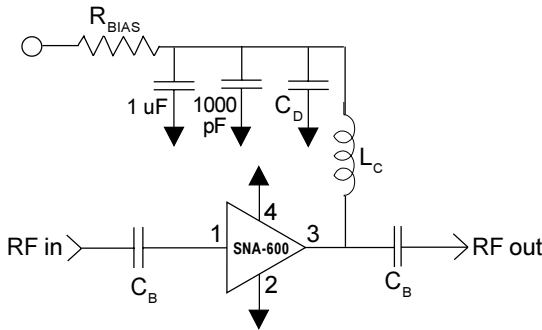

Suggested Bonding Arrangement
(above configuration used for S-parameter data)

Application Circuit Element Values

Reference Designator	Frequency (Mhz)				
	500	850	1950	2400	3500
C _B	220 pF	100 pF	68 pF	56 pF	39 pF
C _D	100 pF	68 pF	22 pF	22 pF	15 pF
L _C	68 nH	33 nH	22 nH	18 nH	15 nH

Recommended Bias Resistor Values for I_b=65mA

$$R_{BIAS} = (V_S - V_D) / I_D$$

Supply Voltage(V _S)	8 V	9 V	10 V	12 V
R _{BIAS}	43 Ω	56 Ω	82 Ω	100 Ω

Note: R_{BIAS} provides DC bias stability over temperature.

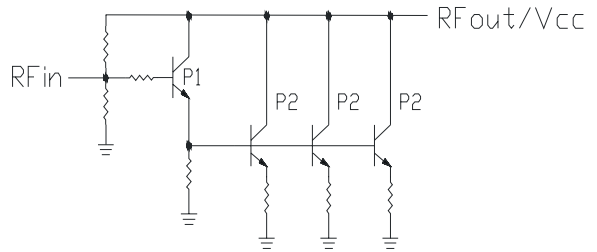

Simplified Schematic of MMIC

For recommended handling, die attach, and bonding methods, see the following application note at www.sirenza.com.

AN-041 (PDF) Handling of Unpackaged Die



Caution: ESD sensitive

Appropriate precautions in handling, packaging and testing devices must be observed.

Part Number Ordering Information

Part Number	Gel Pack
SNA-600	100 pcs. per pack

Die are shipped per Sirenza application note AN-039 Visual Criteria For Unpackaged Die

SUNSTAR 商斯达实业集团是集研发、生产、工程、销售、代理经销、技术咨询、信息服务等为一体的高科技企业，是专业高科技电子产品生产厂家，是具有 10 多年历史的专业电子元器件供应商，是中国最早和最大的仓储式连锁规模经营大型综合电子零部件代理分销商之一，是一家专业代理和分销世界各大品牌 IC 芯片和电子元器件的连锁经营综合性国际公司，专业经营进口、国产名厂名牌电子元件，型号、种类齐全。在香港、北京、深圳、上海、西安、成都等全国主要电子市场设有直属分公司和产品展示展销窗口门市部专卖店及代理分销商，已在全国范围内建成强大统一的供货和代理分销网络。我们专业代理经销、开发生产电子元器件、集成电路、传感器、微波光电元器件、工控机/DOC/DOM 电子盘、专用电路、单片机开发、MCU/DSP/ARM/FPGA 软件硬件、二极管、三极管、模块等，是您可靠的一站式现货配套供应商、方案提供商、部件功能模块开发配套商。商斯达实业公司拥有庞大的资料库，有数位毕业于著名高校——有中国电子工业摇篮之称的西安电子科技大学（西军电）并长期从事国防尖端科技研究的高级工程师为您精挑细选、量身订做各种高科技电子元器件，并解决各种技术问题。

微波光电部专业代理经销高频、微波、光纤、光电元器件、组件、部件、模块、整机；电磁兼容元器件、材料、设备；微波 CAD、EDA 软件、开发测试仿真工具；微波、光纤仪器仪表。欢迎国外高科技微波、光纤厂商将优秀产品介绍到中国、共同开拓市场。长期大量现货专业批发高频、微波、卫星、光纤、电视、CATV 器件：晶振、VCO、连接器、PIN 开关、变容二极管、开关二极管、低噪晶体管、功率电阻及电容、放大器、功率管、MMIC、混频器、耦合器、功分器、振荡器、合成器、衰减器、滤波器、隔离器、环行器、移相器、调制解调器；光电子器件和组件：红外发射管、红外接收管、光电开关、光敏管、发光二极管和发光二极管组件、半导体激光二极管和激光器组件、光电探测器和光接收组件、光发射接收模块、光纤激光器和光放大器、光调制器、光开关、DWDM 用光发射和接收器件、用户接入系统光收发器件与模块、光纤连接器、光纤跳线/尾纤、光衰减器、光纤适配器、光隔离器、光耦合器、光环行器、光复用器/转换器；无线收发芯片和模组、蓝牙芯片和模组。

更多产品请看本公司产品专用销售网站：

商斯达中国传感器科技信息网：<http://www.sensor-ic.com/>

商斯达工控安防网：<http://www.pc-ps.net/>

商斯达电子元器件网：<http://www.sunstare.com/>

商斯达微波光电产品网：[HTTP://www.rfoe.net/](http://www.rfoe.net/)

商斯达消费电子产品网：<http://www.icasic.com/>

商斯达实业科技产品网：<http://www.sunstars.cn/> 微波元器件销售热线：

地址：深圳市福田区福华路福庆街鸿图大厦 1602 室

电话：0755-82884100 83397033 83396822 83398585

传真：0755-83376182 (0) 13823648918 MSN: SUNS8888@hotmail.com

邮编：518033 E-mail:szss20@163.com QQ: 195847376

深圳赛格展销部：深圳华强北路赛格电子市场 2583 号 电话：0755-83665529 25059422

技术支持：0755-83394033 13501568376

欢迎索取免费详细资料、设计指南和光盘；产品凡多，未能尽录，欢迎来电查询。

北京分公司：北京海淀区知春路 132 号中发电子大厦 3097 号

TEL: 010-81159046 82615020 13501189838 FAX: 010-62543996

上海分公司：上海市北京东路 668 号上海赛格电子市场 D125 号

TEL: 021-28311762 56703037 13701955389 FAX: 021-56703037

西安分公司：西安高新开发区 20 所(中国电子科技集团导航技术研究所)

西安劳动南路 88 号电子商城二楼 D23 号

TEL: 029-81022619 13072977981 FAX:029-88789382