



Product Description

The Sirenza Microdevices' STM-1116 is a high linearity active mixer for use in a wide variety of communication systems covering the 800-1000 MHz frequency bands. This device operates from a single 5V supply and provides 14 dB of conversion gain while requiring only 0dBm input to the integrated LO driver. The STM-1116 also includes an integrated on chip IF amplifier and is fabricated using Silicon Germanium (SiGe) device technology.

The RF and LO ports can be driven differential or single ended. Each broadband port has been designed to minimize performance degradation while operating into highly reactive components such as SAW filters. The device is packaged in an industry standard 16 pin TSSOP with exposed paddle for superb RF and thermal ground.

Functional Block Diagram

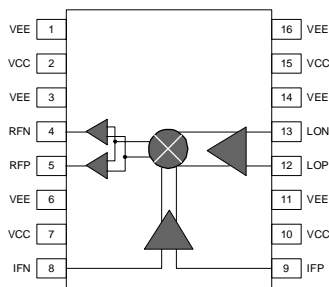

Product Specifications

Parameters	Test Conditions: $T_A = 25^\circ\text{C}$, $V_{CC} = 5.0\text{V}$, $P_{LO} = 0\text{dBm}$, $P_{IF} = -20\text{dBm}$, $f_F = 200\text{MHz}$	Unit	Min.	Typ.	Max.	Min.	Typ.	Max.
RF Frequency Range		MHz	800		900	900		1000
LO Frequency Range		MHz	600		700	700		800
IF Frequency Range		MHz	30	200	400	30	200	400
Conversion Gain		dB	9	12	16	11	14	16
SSB Noise Figure		dB		9.0	11		9.0	11
Output IP3	IF1 = IF2 = -20 dBm/tone, 1 MHz spacing	dBm	17	21		19	22	
Output P1dB		dBm	5	7		6	8.5	
Leakage (LO-RF)		dBm		-35	-25		-30	-20
Leakage (LO-IF)		dBm		-40	-30		-35	-25
RF, LO, IF Return Loss	Matched to 50Ω, see Note 1, page 3	dB		14			14	
Supply Voltage (Vcc)		V	+4.75	+5.0	+5.25	+4.75	+5.0	+5.25
Supply Current		mA		200			200	
LO Drive	Matched to 50Ω	dBm	-3	0	+3	-3	0	+3
Thermal Resistance	junction-case	°C/W		25			25	

The information provided herein is believed to be reliable at press time. Sirenza Microdevices assumes no responsibility for inaccuracies or omissions. Sirenza Microdevices assumes no responsibility for the use of this information, and all such information shall be entirely at the user's own risk. Prices and specifications are subject to change without notice. No patent rights or licenses to any of the circuits described herein are implied or granted to any third party. Sirenza Microdevices does not authorize or warrant any Sirenza Microdevices product for use in life-support devices and/or systems.

Copyright 2002 Sirenza Microdevices, Inc. All worldwide rights reserved.

522 Almanor Ave., Sunnyvale, CA 94085

Phone: (800) SMI-MMIC

1

<http://www.sirenza.com>

EDS102185 Rev B

Preliminary

STM-1116

800 - 1000 MHz High Linearity Active Transmit Mixer



16 pin TSSOP with Exposed Ground Pad

Package Footprint: 0.197 x 0.252 inches (5.0 x 6.4 mm)

Package Height: 0.039 inches (1.0 mm)

Product Features

- Active mixer with 14 dB conversion gain
- Integrated 0dBm LO drive and IF amplifier
- Differential or single-ended input
- Single supply operation (+5V)
- Broadband resistive 50Ω impedance on all three ports
- Low LO-RF leakage

Applications

- AMPS/GSM/CDMA800 transmitters



STM-1116 SiGe Active Transmit Mixer

800-1000MHz Typical Device Performance

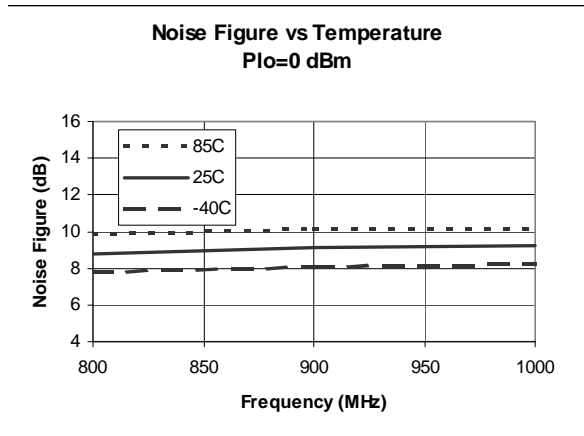
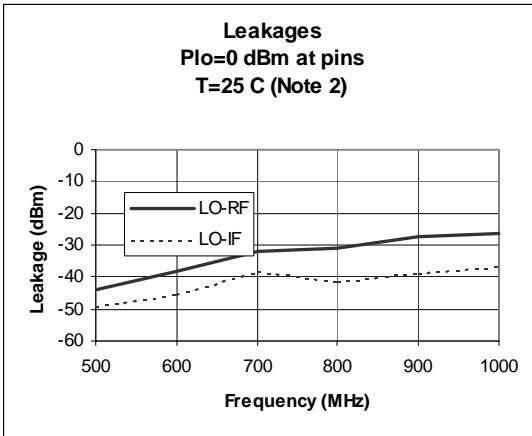
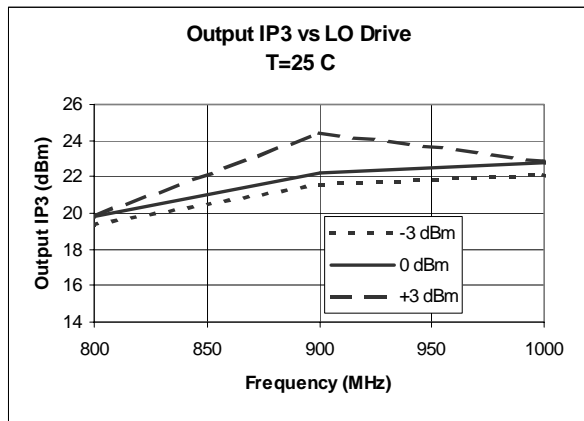
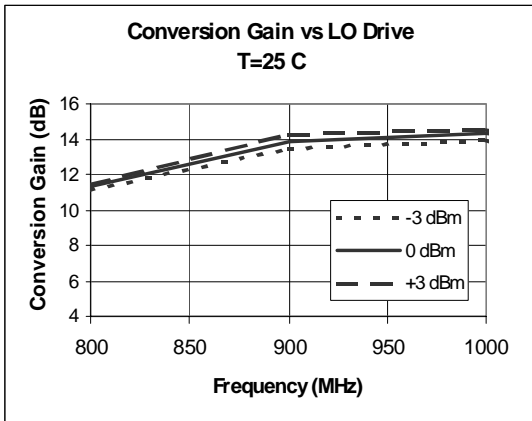
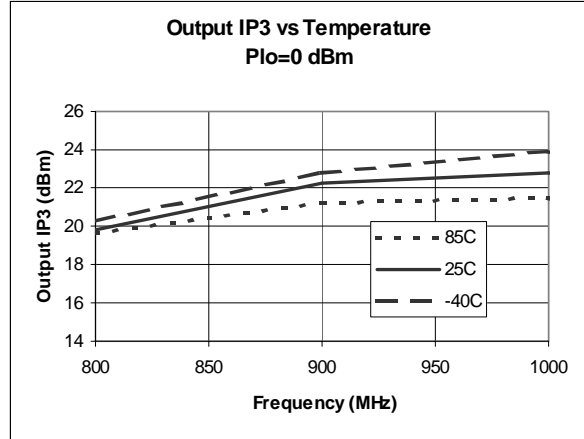
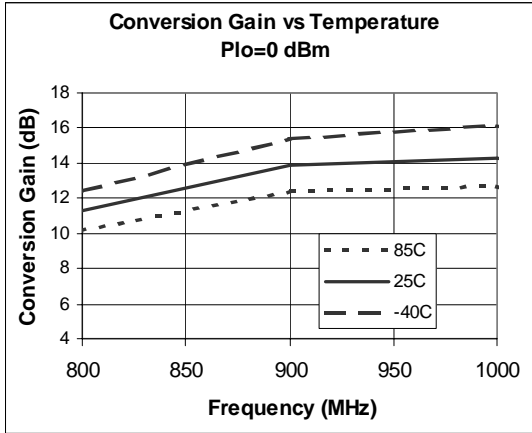



STM-1116 SiGe Active Transmit Mixer

800-1000MHz Typical Device Performance (continued)

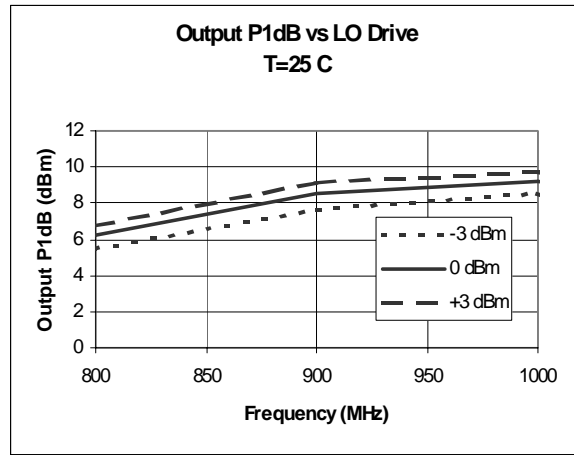
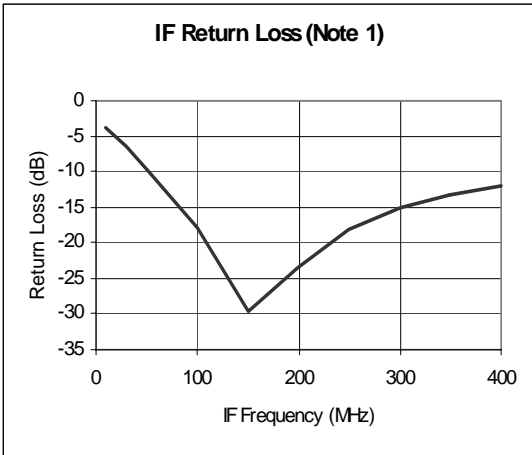
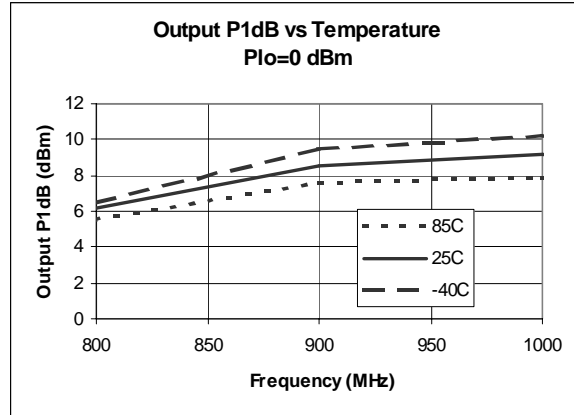
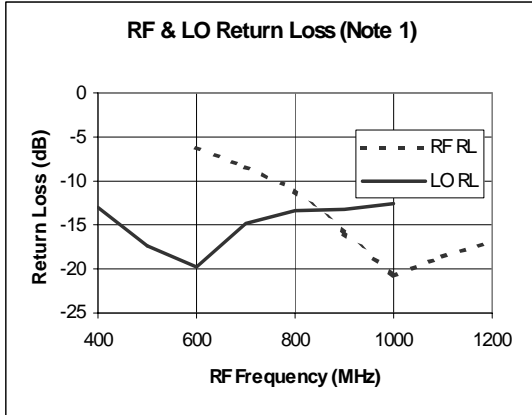

Note 1: The return losses shown were measured with the STM-1116 mounted on our FR4 evaluation boards. The RF port was matched for the GSM band, and the IF port matched for 200 MHz. Similar return losses are achievable at other frequencies using standard matching practices.

Note 2: LO-IF leakage measurement has not been adjusted for the loss through the IF (TC1-1) balun.



STM-1116 SiGe Active Transmit Mixer

Package Dimensions ("16" Package)

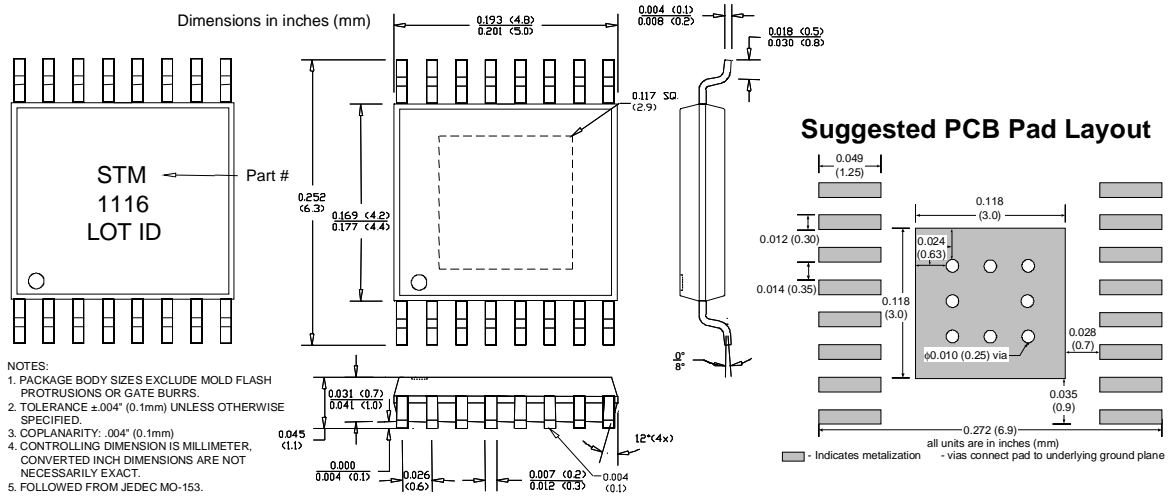

Pin Out Description

Pin #	Function	Description	Additional Comments
1	VEE	Ground	
2	VCC	Positive supply (+5V)	
3	VEE	Ground	
4	RFN	RF output, negative terminal	Nominal DC voltage is 2.3V. (Internally biased) Output should be AC-coupled.
5	RFP	RF output, positive terminal	Nominal DC voltage is 2.3V. (Internally biased) Output should be AC-coupled.
6	VEE	Ground	
7	VCC	Positive supply (+5V)	
8	IFN	IF input, negative terminal	Nominal DC voltage is 2.3V. (Internally biased) Input should be AC-coupled.
9	IFP	IF input, positive terminal	Nominal DC voltage is 2.3V. (Internally biased) Input should be AC-coupled.
10	VCC	Positive supply (+5V)	
11	VEE	Ground	
12	LOP	LO input, positive terminal	Nominal DC voltage is 2.3V. (Internally biased) Input should be AC-coupled.
13	LON	LO input, negative terminal	Nominal DC voltage is 2.3V. (Internally biased) Input should be AC-coupled.
14	VEE	Ground	
15	VCC	Positive supply (+5V)	
16	VEE	Ground	

Absolute Maximum Ratings

Parameters	Value	Unit
Supply Voltage (Vcc)	+6.0	V _{DC}
LO Input (LOP+LON)	+10	dBm
IF Input (IFP, IFN)	+15	dBm
Operating Temperature	-40 to +85	°C
Storage Temperature	-65 to +150	°C

Operation of this device beyond any one of these limits may cause permanent damage. For reliable continuous operation the device voltage and current must not exceed the maximum operating values specified in the table on page one.

Part Number Ordering Information

Part Number	Reel Size	Devices/Reel	
		Min.	Max.
STM-1116	7"	500	1000

Moisture sensitivity level 1 - no special handling required



Caution: ESD Sensitive

Appropriate precaution in handling, packaging and testing devices must be observed.



STM-1116 SiGe Active Transmit Mixer

800-1000MHz Application Schematic

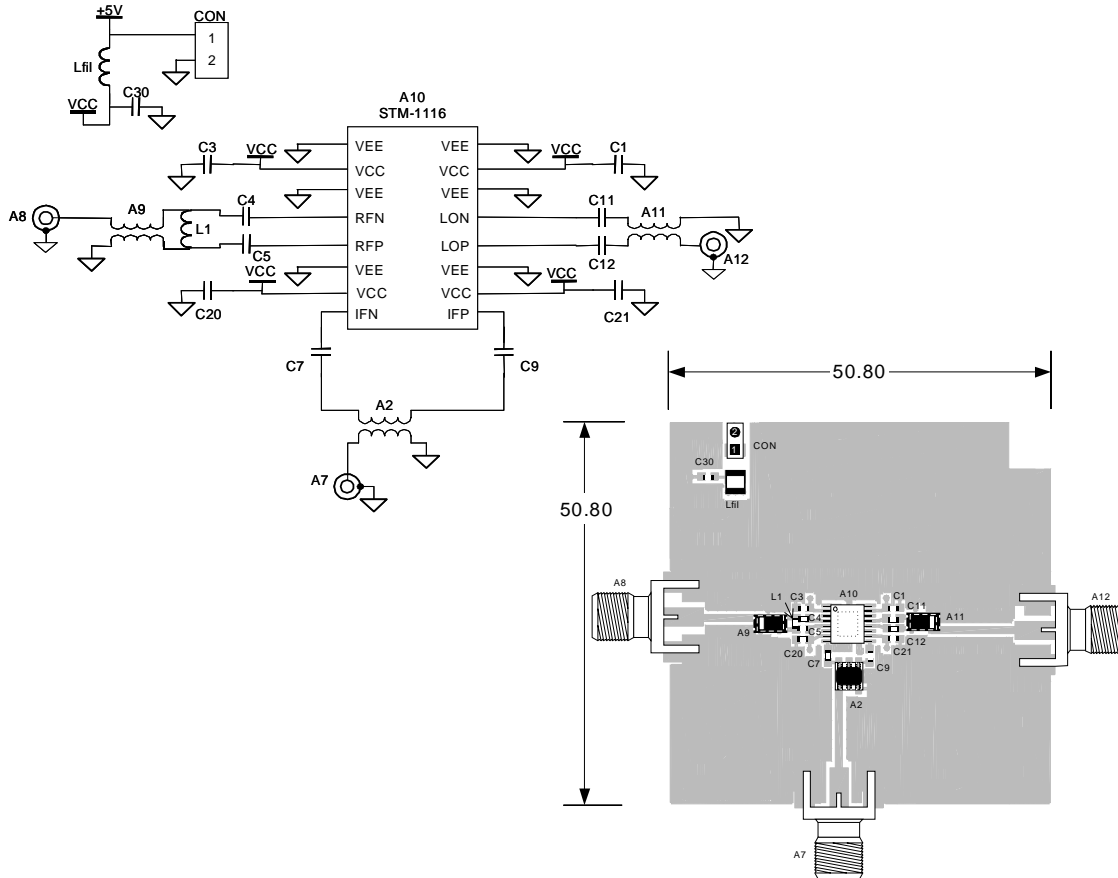

Bill of Materials (for 800-1000MHz Evaluation Board P/N EEB102189)

Component Designator	Value	Qty	Vendor	Part Number	Description
A10		1	SMDI	STM-1116	SiGe Transmit Mixer
A7, A8, A12		3	Johnson Components	142-0701-851	SMA connector, end launch with tab, for 62 mil pitch thick board
CON		1	Digikey	S1212-36-ND	2-pin header
A9, A11	1:1	2	Panasonic	EHF-FD1618	RF transformer
A2	1:1	1	Mini-Circuits	TC1-1	IF transformer
Lfil	1uH	1	Digikey	PCD1008CT-ND	Inductor, 1210 footprint, min. 200mA rating
C1, C3, C20, C21, C30	27pF	5	Venkel	C0603COG500-270JNE	Capacitor, 0603 footprint
C7, C9	100pF	2	Venkel	C0603COG500-101JNE	Capacitor, 0603 footprint
C4, C5	5.6pF	2	Venkel	C0603COG500-5R6CNE	Capacitor, 0603 footprint
L1	39nH	1	TOKO	LL1608-FS39NJ	Inductor, 0603 footprint
C11, C12	22pF	2	Venkel	C0603COG500-220JNE	Capacitor, 0603 footprint

522 Almanor Ave., Sunnyvale, CA 94085

Phone: (800) SMI-MMIC
5

<http://www.sirenza.com>
EDS102185 Rev B



STM-1116 SiGe Active Transmit Mixer

SiGe Transmit Mixer: General Test Set-Up

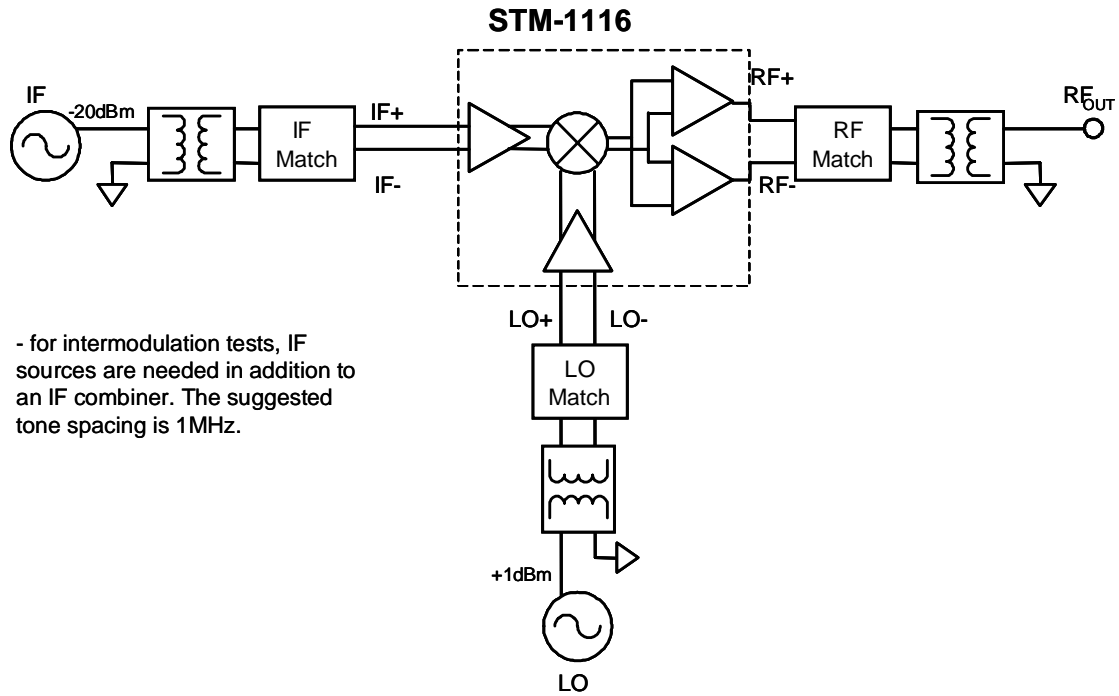

SUNSTAR 商斯达实业集团是集研发、生产、工程、销售、代理经销、技术咨询、信息服务等为一体的高科技企业，是专业高科技电子产品生产厂家，是具有 10 多年历史的专业电子元器件供应商，是中国最早和最大的仓储式连锁规模经营大型综合电子零部件代理分销商之一，是一家专业代理和分销世界各大品牌 IC 芯片和电子元器件的连锁经营综合性国际公司，专业经营进口、国产名厂名牌电子元件，型号、种类齐全。在香港、北京、深圳、上海、西安、成都等全国主要电子市场设有直属分公司和产品展示展销窗口门市部专卖店及代理分销商，已在全国范围内建成强大统一的供货和代理分销网络。我们专业代理经销、开发生产电子元器件、集成电路、传感器、微波光电元器件、工控机/DOC/DOM 电子盘、专用电路、单片机开发、MCU/DSP/ARM/FPGA 软件硬件、二极管、三极管、模块等，是您可靠的一站式现货配套供应商、方案提供商、部件功能模块开发配套商。商斯达实业公司拥有庞大的资料库，有数位毕业于著名高校——有中国电子工业摇篮之称的西安电子科技大学（西军电）并长期从事国防尖端科技研究的高级工程师为您精挑细选、量身订做各种高科技电子元器件，并解决各种技术问题。

微波光电部专业代理经销高频、微波、光纤、光电元器件、组件、部件、模块、整机；电磁兼容元器件、材料、设备；微波 CAD、EDA 软件、开发测试仿真工具；微波、光纤仪器仪表。欢迎国外高科技微波、光纤厂商将优秀产品介绍到中国、共同开拓市场。长期大量现货专业批发高频、微波、卫星、光纤、电视、CATV 器件：晶振、VCO、连接器、PIN 开关、变容二极管、开关二极管、低噪晶体管、功率电阻及电容、放大器、功率管、MMIC、混频器、耦合器、功分器、振荡器、合成器、衰减器、滤波器、隔离器、环行器、移相器、调制解调器；光电子器件和组件：红外发射管、红外接收管、光电开关、光敏管、发光二极管和发光二极管组件、半导体激光二极管和激光器组件、光电探测器和光接收组件、光发射接收模块、光纤激光器和光放大器、光调制器、光开关、DWDM 用光发射和接收器件、用户接入系统光收发器件与模块、光纤连接器、光纤跳线/尾纤、光衰减器、光纤适配器、光隔离器、光耦合器、光环行器、光复用器/转换器；无线收发芯片和模组、蓝牙芯片和模组。

更多产品请看本公司产品专用销售网站：

商斯达中国传感器科技信息网：<http://www.sensor-ic.com/>

商斯达工控安防网：<http://www.pc-ps.net/>

商斯达电子元器件网：<http://www.sunstare.com/>

商斯达微波光电产品网：[HTTP://www.rfoe.net/](http://www.rfoe.net/)

商斯达消费电子产品网：<http://www.icasic.com/>

商斯达实业科技产品网：<http://www.sunstars.cn/> 微波元器件销售热线：

地址：深圳市福田区福华路福庆街鸿图大厦 1602 室

电话：0755-82884100 83397033 83396822 83398585

传真：0755-83376182 (0) 13823648918 MSN: SUNS8888@hotmail.com

邮编：518033 E-mail:szss20@163.com QQ: 195847376

深圳赛格展销部：深圳华强北路赛格电子市场 2583 号 电话：0755-83665529 25059422

技术支持：0755-83394033 13501568376

欢迎索取免费详细资料、设计指南和光盘；产品凡多，未能尽录，欢迎来电查询。

北京分公司：北京海淀区知春路 132 号中发电子大厦 3097 号

TEL: 010-81159046 82615020 13501189838 FAX: 010-62543996

上海分公司：上海市北京东路 668 号上海赛格电子市场 D125 号

TEL: 021-28311762 56703037 13701955389 FAX: 021-56703037

西安分公司：西安高新开发区 20 所(中国电子科技集团导航技术研究所)

西安劳动南路 88 号电子商城二楼 D23 号

TEL: 029-81022619 13072977981 FAX:029-88789382