

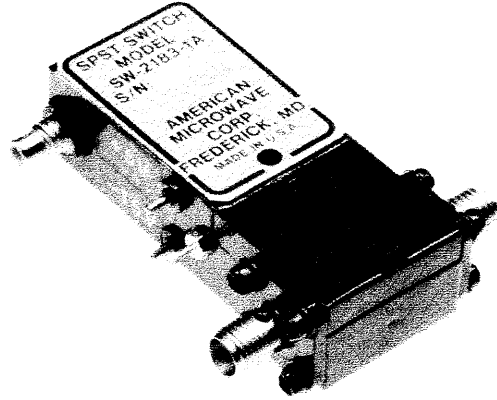

AMERICAN Microwave Corporation

SERIES SW-218 WIDEBAND SPST PIN DIODE SWITCHES WITH INTEGRAL DRIVERS



FEATURES

- 0.5 to 18 GHz Frequency Range
- Low Insertion Loss
- Up to 85 dB Isolation
- High Speed - 10 nsec
- Small Size
- Light Weight
- Rugged Chip and Microstrip Construction

DESCRIPTION

The series SW-218 switches are broadband, high speed, low loss SPST switches with integral drivers. They are powered by +5 and -15 volt supplies and are available powered by ± 15 volts. They are available in three models that operate over the entire 0.5 to 18 GHz band. Each features rugged integrated circuit assemblies of chip PIN on a microstrip transmission line and proprietary wideband bias decoupling circuitry.

Switching is accomplished by a TTL compatible driver which is controlled by the user.

SPECIFICATIONS

- Control Impedance - TTL Compatible, Two Load. (A Load is 1.6 mA Sink Current and 40 μ A Source Current.)
- Control Logic - Logic "0" (-0.3 to +0.7 Volt) for Switch OFF. Logic "1" (+2.5 to +5.0 Volts) for Switch ON.
- Temperature - Operating: -65°C to +85°C Non-operating: -65°C to +125°C
- Humidity, Shock, Etc. - Per MIL-STD 202C

FUNCTIONAL SCHEMATIC

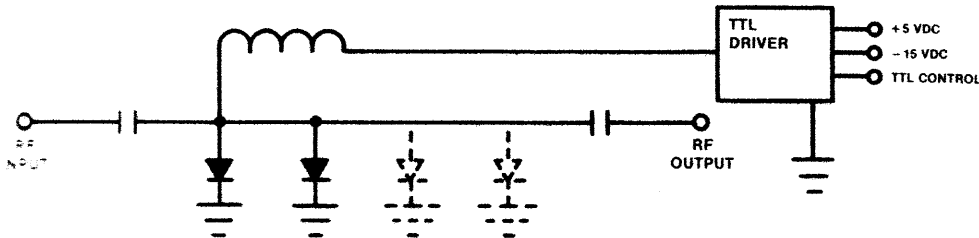

10/89

7311G GROVE ROAD, FREDERICK, MARYLAND 21701 (301) 662-4700

SPECIFICATIONS, Cont'd.

MODEL NO.	CHARACTERISTICS	FREQUENCY (GHz)						RISE/FALL * TIME	POWER HANDLING CAPABILITY		POWER SUPPLY		
		0.5 to 1.0	1.0 to 2.0	2.0 to 4.0	4.0 to 8.0	8.0 to 12.4	12.4 to 18.0		ON-to-OFF and OFF-to-ON	AVG (WATTS)	Peak 1 μ sec, max, pw (WATTS)	+ 15 VDC	+ 5 VDC
SW-2182-1A	Min Isolation (dB)	30	40	45	45	45	45	10 ns	2	10	100 mA	100 mA	45 mA
	Max Ins Loss (dB)	1.0	1.0	1.0	1.1	1.6	2.0						
	Max VSWR (ON Pos)	1.3	1.3	1.4	1.6	1.9	1.9						
SW-2183-1A	Min Isolation (dB)	40	60	70	70	70	70	10	2	10	100 mA	100 mA	45 mA
	Max Ins Loss (dB)	1.0	1.0	1.1	1.4	1.8	2.3						
	Max VSWR (ON Pos)	1.4	1.4	1.4	1.6	1.9	1.9						
SW-2184-1A	Min Isolation (dB)	45	70	85	85	85	80	10	2	10	100 mA	100 mA	45 mA
	Max Ins Loss (dB)	1.0	1.0	1.2	1.5	2.0	2.5						
	Max VSWR (ON Pos)	1.4	1.4	1.4	1.6	1.9	1.9						

*Rise/Fall times are 10% to 90% RF
and 90% to 10% RF.

*TTL delay is 20 ns, Max from 50% TTL
to 90% RF for turn-off or
50% TTL to 10% RF for turn-on.

ENVIRONMENTAL RATINGS

Operating Temperature - 65° C to 110° C
 Non-Operating Temperature - 65° C to 125° C
 Humidity MIL-STD-202F, METHOD 103B
 Shock MIL-STD-202F, METHOD 213B
 Vibration MIL-STD-202F, METHOD 204D
 Altitude MIL-STD-202F, METHOD 105C
 Temp Cycling MIL-STD-202F, METHOD 107D

AVAILABLE OPTIONS

Option No.	Description
001	Two SMA Male RF Connectors
002	One SMA Male and One SMA Female RF Connector
003	Solder Type Control Terminals
004	\pm 15 Volt Power Supply Requirement (+ 5, - 15 Volt is Standard)
005	50 Ohm Control Impedance
006	Cannon Multipin MDM9SSP
007	Inverted Logic
008	Extend Frequency to 100 MHz
010	50 ns, Max Switching Speed (5 watts, cw, max)
012	2 ns, Max Switching Speed (100 mw, cw, max)
013	- 12 VDC Power Supply Requirement
103	Integral Video Filters (2-18 GHz Frequency Band)

TYPICAL PERFORMANCE

PULSE CHARACTERISTICS

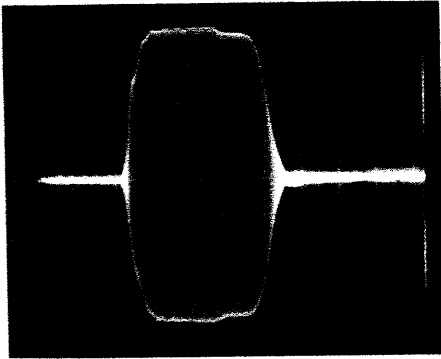

TYPICAL
15 ns Pulse Modulated
Signal at 2.3 GHz
(5 ns/Division)
SW-2184-1A, Option 012, 103

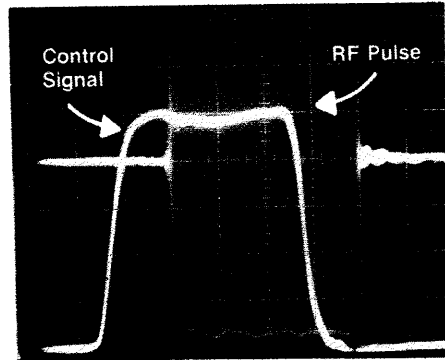

TYPICAL
40 ns Pulse Modulated Signal
at 7 GHz with Control
Pulse Super-imposed
(10 ns/Division)
SW-2184-1A, Option 012, 103

STATIC RESPONSE

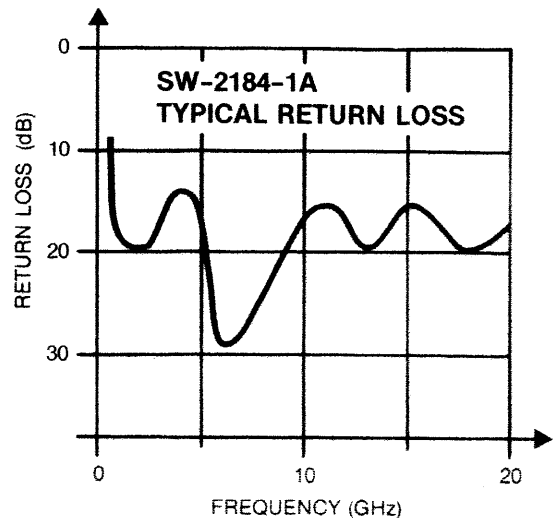
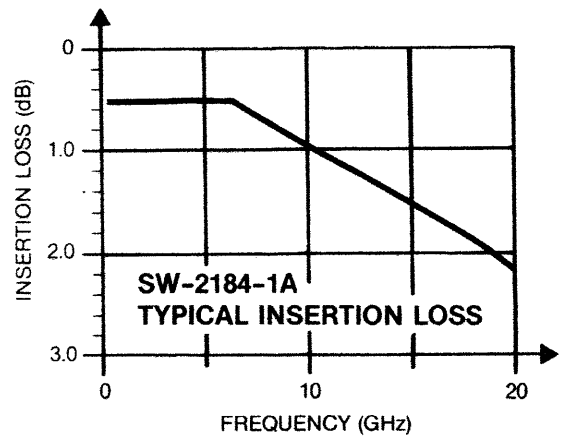
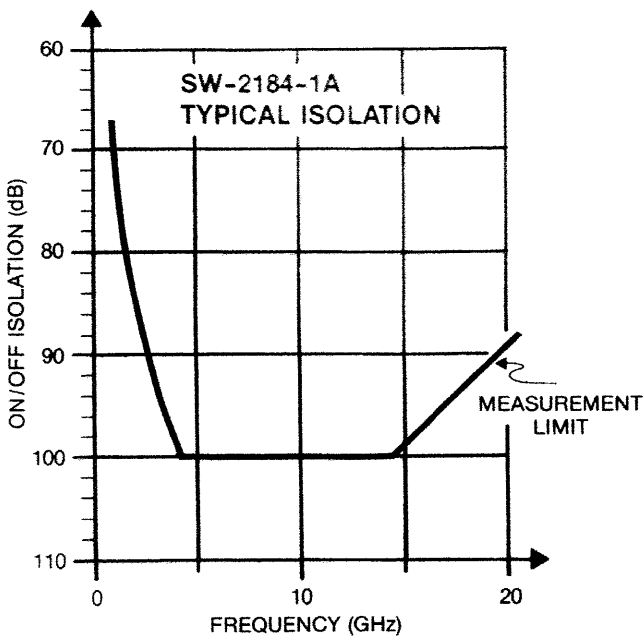

MECHANICAL DATA

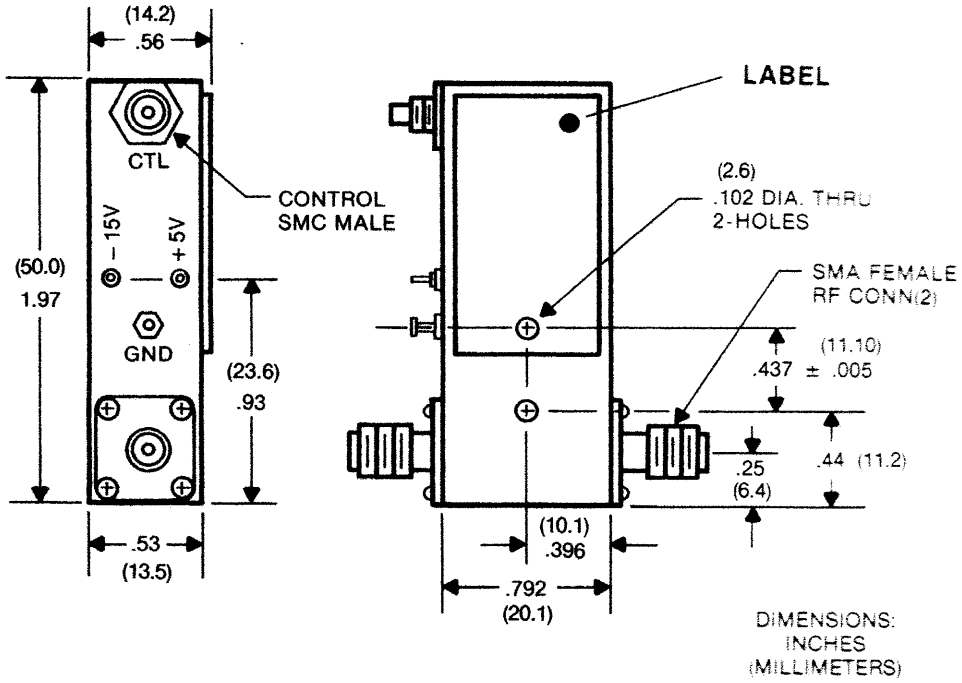

TRUTH TABLE

Logic	RF
0	OFF
1	ON

SUNSTAR 商斯达实业集团是集研发、生产、工程、销售、代理经销、技术咨询、信息服务等为一体的高科技企业，是专业高科技电子产品生产厂家，是具有 10 多年历史的专业电子元器件供应商，是中国最早和最大的仓储式连锁规模经营大型综合电子零部件代理分销商之一，是一家专业代理和分销世界各大品牌 IC 芯片和电子元器件的连锁经营综合性国际公司，专业经营进口、国产名厂名牌电子元件，型号、种类齐全。在香港、北京、深圳、上海、西安、成都等全国主要电子市场设有直属分公司和产品展示展销窗口门市部专卖店及代理分销商，已在全国范围内建成强大统一的供货和代理分销网络。我们专业代理经销、开发生产电子元器件、集成电路、传感器、微波光电元器件、工控机/DOC/DOM 电子盘、专用电路、单片机开发、MCU/DSP/ARM/FPGA 软件硬件、二极管、三极管、模块等，是您可靠的一站式现货配套供应商、方案提供商、部件功能模块开发配套商。商斯达实业公司拥有庞大的资料库，有数位毕业于著名高校——有中国电子工业摇篮之称的西安电子科技大学（西军电）并长期从事国防尖端科技研究的高级工程师为您精挑细选、量身订做各种高科技电子元器件，并解决各种技术问题。

微波光电部专业代理经销高频、微波、光纤、光电元器件、组件、部件、模块、整机；电磁兼容元器件、材料、设备；微波 CAD、EDA 软件、开发测试仿真工具；微波、光纤仪器仪表。欢迎国外高科技微波、光纤厂商将优秀产品介绍到中国、共同开拓市场。长期大量现货专业批发高频、微波、卫星、光纤、电视、CATV 器件：晶振、VCO、连接器、PIN 开关、变容二极管、开关二极管、低噪晶体管、功率电阻及电容、放大器、功率管、MMIC、混频器、耦合器、功分器、振荡器、合成器、衰减器、滤波器、隔离器、环行器、移相器、调制解调器；光电子器件和组件：红外发射管、红外接收管、光电开关、光敏管、发光二极管和发光二极管组件、半导体激光二极管和激光器组件、光电探测器和光接收组件、光发射接收模块、光纤激光器和光放大器、光调制器、光开关、DWDM 用光发射和接收器件、用户接入系统光收发器件与模块、光纤连接器、光纤跳线/尾纤、光衰减器、光纤适配器、光隔离器、光耦合器、光环行器、光复用器/转换器；无线收发芯片和模组、蓝牙芯片和模组。

更多产品请看本公司产品专用销售网站：

商斯达中国传感器科技信息网：<http://www.sensor-ic.com/>

商斯达工控安防网：<http://www.pc-ps.net/>

商斯达电子元器件网：<http://www.sunstare.com/>

商斯达微波光电产品网：[HTTP://www.rfoe.net/](http://www.rfoe.net/)

商斯达消费电子产品网：<http://www.icasic.com/>

商斯达实业科技产品网：<http://www.sunstars.cn/> 微波元器件销售热线：

地址：深圳市福田区福华路福庆街鸿图大厦 1602 室

电话：0755-82884100 83397033 83396822 83398585

传真：0755-83376182 (0) 13823648918 MSN: SUNS8888@hotmail.com

邮编：518033 E-mail:szss20@163.com QQ: 195847376

深圳赛格展销部：深圳华强北路赛格电子市场 2583 号 电话：0755-83665529 25059422

技术支持：0755-83394033 13501568376

欢迎索取免费详细资料、设计指南和光盘；产品凡多，未能尽录，欢迎来电查询。

北京分公司：北京海淀区知春路 132 号中发电子大厦 3097 号

TEL: 010-81159046 82615020 13501189838 FAX: 010-62543996

上海分公司：上海市北京东路 668 号上海赛格电子市场 D125 号

TEL: 021-28311762 56703037 13701955389 FAX: 021-56703037

西安分公司：西安高新开发区 20 所(中国电子科技集团导航技术研究所)

西安劳动南路 88 号电子商城二楼 D23 号

TEL: 029-81022619 13072977981 FAX:029-88789382