

SINGLE-SUPPLY OPERATIONAL AMPLIFIER

■ GENERAL DESCRIPTION

The NJM2125 is a single-supply operational amplifier of small surface mount package.

The features of single-supply operation, low operating voltage (minimum 2.7V) and small package are most suitable for portable items.

■ PACKAGE OUTLINE



NJM2125F



NJM2125PB1

■ FEATURES

- Single-Supply Operation
- Low Operating Voltage (+2.7V~20V)
- Low Operating Current (1.0mA typ.)
- Slew Rate (1.2V/μs typ.)
- Small Package (MTP5,FFP12)
- Bipolar Technology

■ PIN CONFIGURATION

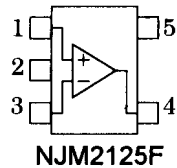

PIN FUNCTION

- 1.+INPUT
- 2.GND
- 3.-INPUT
- 4.OUTPUT
- 5.V⁺

(TOP VIEW)

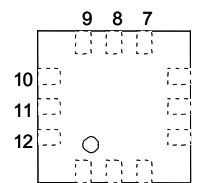

PIN FUNCTION

- 1.+INPUT
- 2.NC
- 3.-INPUT
- 4.NC
- 5.GND
- 6.NC
- 7.OUTPUT
- 8.NC
- 9.V⁺
- 10.NC
- 11.NC
- 12.NC

■ EQUIVALENT CIRCUIT

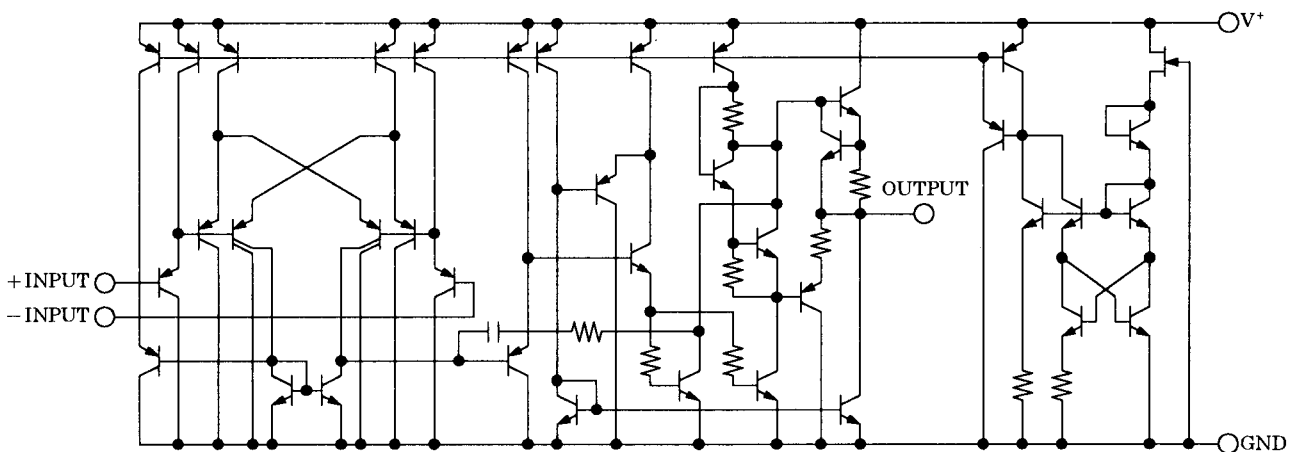

NJM2125

■ ABSOLUTE MAXIMUM RATINGS

(Ta=25°C)

PARAMETER	SYMBOL	RATINGS	UNIT
Supply Voltage	V^+	+20	V
Differential Input Voltage	V_{ID}	+20	V
Input Voltage	V_{IC}	-0.3~+20 (note1)	V
Power Dissipation	P_D	(MTP-5)200 (FFP12)300(note2)	mW
Operating Temperature Range	T_{opr}	-40~85	°C
Storage Temperature Range	T_{stg}	-40~125	°C

(note1) When the supply voltage is less than +20V, the absolute maximum input voltage is equal to the supply voltage.

(note2)On glass epoxy board.

■ ELECTRICAL CHARACTERISTICS

($V^+=5V, Ta=25^\circ C$)

PARAMETER	SYMBOL	TEST CONDITION	MIN.	TYP.	MAX.	UNIT
Input Offset Voltage	V_{IO}	$R_S=0\Omega$	-	2	7	mV
Input Offset Current	I_{IO}		-	5	50	nA
Input Bias Current	I_B		-	25	250	nA
Large Signal Voltage Gain	A_V	$R_L \geq 2k\Omega$	88	100	-	dB
Maximum Output Voltage Swings	V_{OM}	$R_L=2k\Omega$	3.5	-	-	V
Input Common Mode Voltage Range	V_{ICM}		0~3.5	-	-	V
Common Mode Rejection Ratio	CMR		70	90	-	dB
Supply Voltage Rejection Ratio	SVR		80	94	-	dB
Output Source Current	I_{SOURCE}	$V_{IN}^+=1V, V_{IN}^-=0V$	20	30	-	mA
Output Sink Current	I_{SINK}	$V_{IN}^+=0V, V_{IN}^-=1V$	8	20	-	mA
Operating Current	I_{CC}	$R_L=\infty$	-	1.0	1.75	mA
Slew Rate	SR		-	1.2	-	V/ μs
Unity Gain Frequency	f_T		-	1.2	-	MHz

■ TYPICAL CHARACTERISTICS

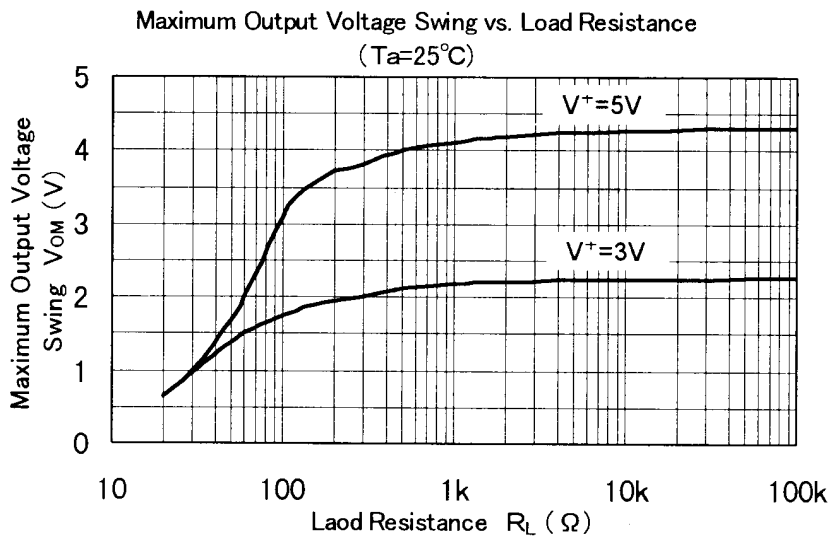
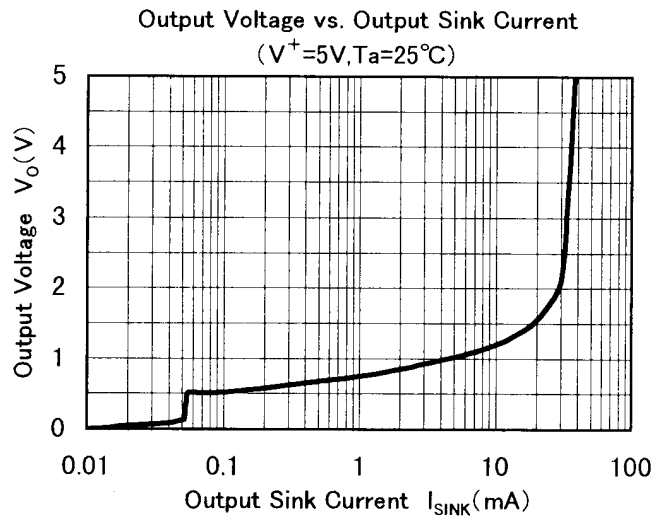
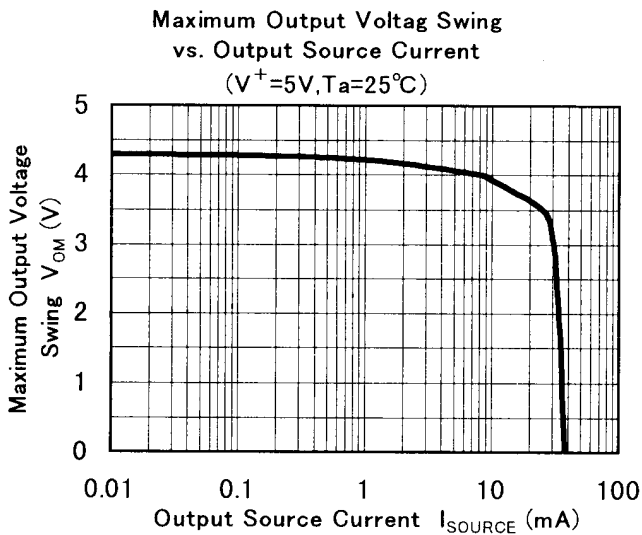
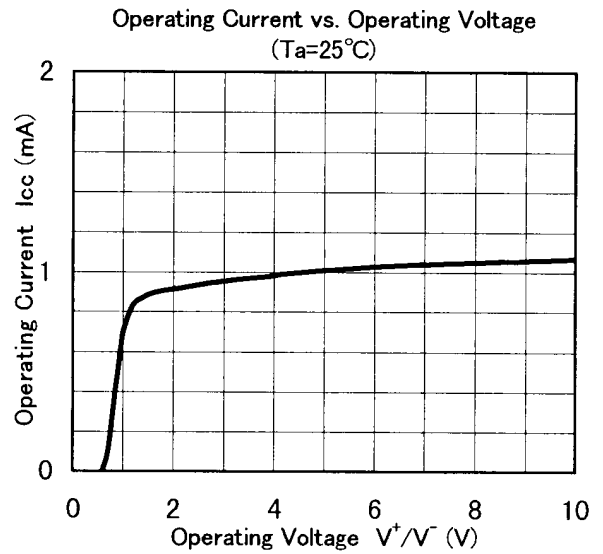
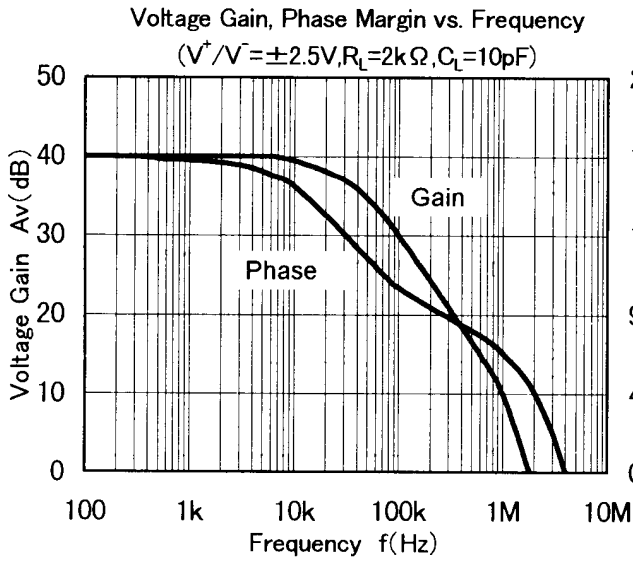

■ TYPICAL CHARACTERISTICS

Operating Current vs. Temperature
($V^+/V^- = \pm 2.5V$)

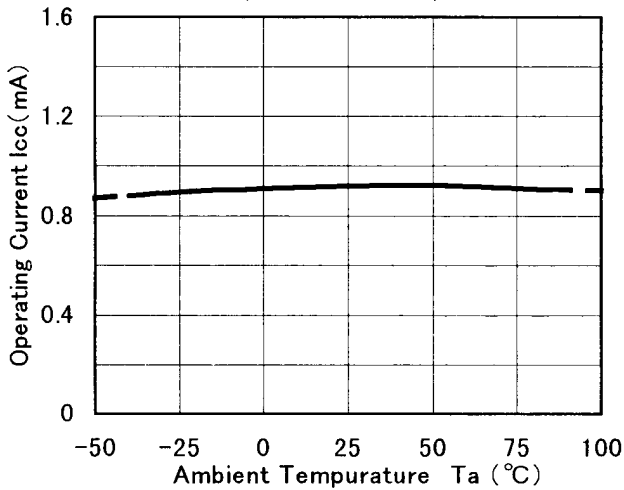

Input Offset Voltage vs. Temperature
($V^+ = 5V, R_s = 0\Omega$)

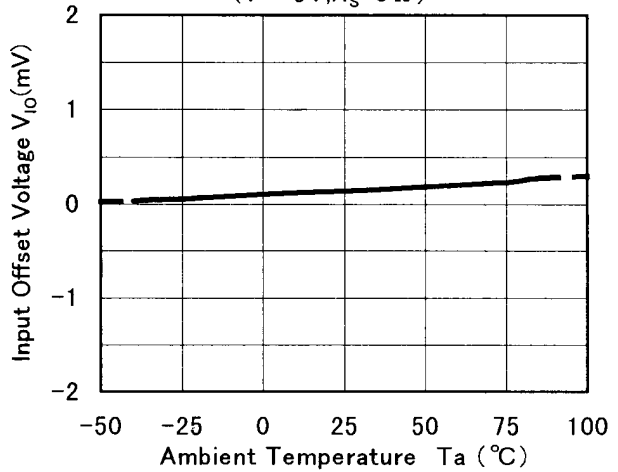

Input Offset Current vs. Temperature
($V^+ = 5V$)

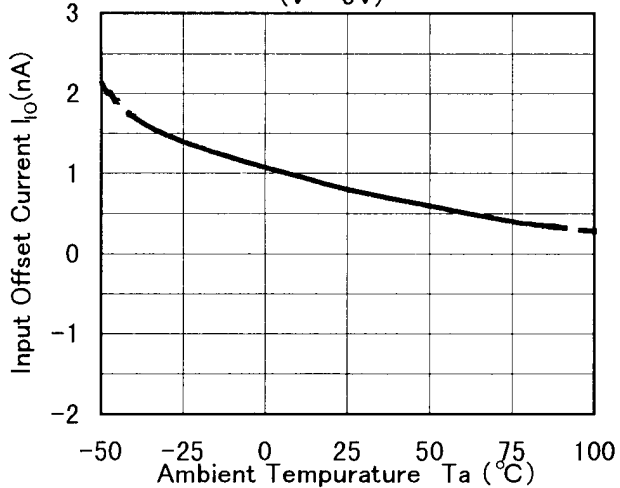

Input Bias Current vs. Temperature
($V^+ = 5V$)

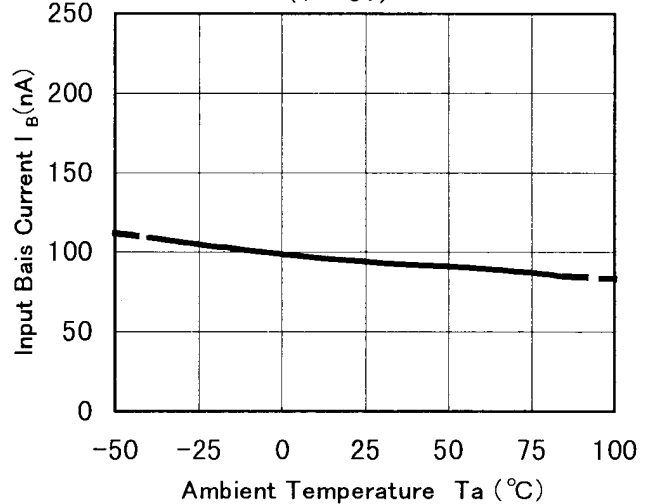

Maximum Output Voltage Swing vs. Temperature
($V^+ = 5V, R_L = 2k\Omega$)

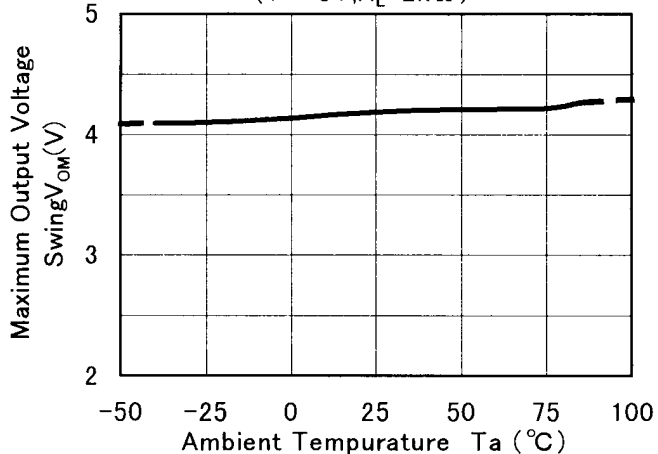

[CAUTION]

The specifications on this databook are only given for information, without any guarantee as regards either mistakes or omissions. The application circuits in this databook are described only to show representative usages of the product and not intended for the guarantee or permission of any right including the industrial rights.