

## SINGLE-SUPPLY DUAL OPERATIONAL AMPLIFIER

### ■ GENERAL DESCRIPTION

The NJM2904 consists of two independent, high gain, internally frequency compensated operation amplifiers which were designed specifically to operate from a single power supply over a wide range of voltages. Operation from split power supplies is also possible and the low power supply current drain is independent of the magnitude of the power supply voltage.

Application areas include transducer amplifiers, DC gain blocks, and all the conventional op amp circuits which now can be more easily implemented in single power supply systems. For example, the NJM2904 can be directly operated off of the standard +5V power supply voltage which is used in digital systems and will easily provide the required interface electronics without requiring the additional  $\pm 15V$  power supplies.

### ■ FEATURES

- Single Supply
- Operating Voltage ( +3V~+32V )
- Low Operating Current ( 0.7mA typ. )
- Slew Rate ( 0.5V/ $\mu$ s typ. )
- Bipolar Technology
- Package Outline DIP8, DMP8, SIP8, SSOP8

### ■ PIN CONFIGURATION

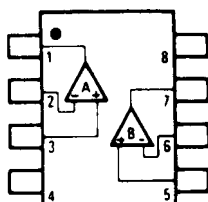

NJM2904D  
NJM2904M  
NJM2904V

**PIN FUNCTION**  
 1.A OUTPUT  
 2.A -INPUT  
 3.A +INPUT  
 4.GND  
 5.B +INPUT  
 6.B -INPUT  
 7.B OUTPUT  
 8.V<sup>+</sup>

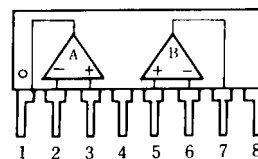

NJM2904L

### ■ PACKAGE OUTLINE

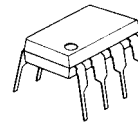

NJM2904D

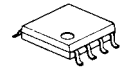

NJM2904M



NJM2904V

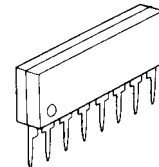

NJM2904L

### ■ EQUIVALENT CIRCUIT ( 1/2 Shown )

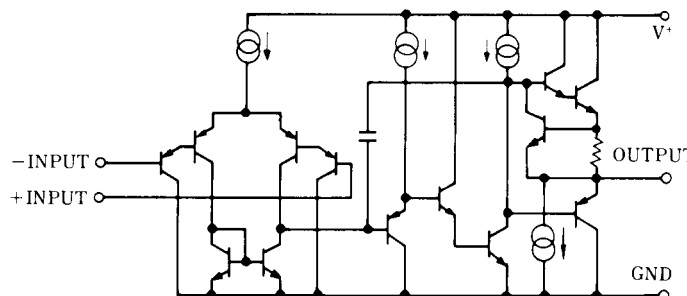

# NJM2904

## ■ ABSOLUTE MAXIMUM RATINGS

( Ta=25°C )

PARAMETER	SYMBOL	RATINGS	UNIT
Supply Voltage	$V^+(V^-/V)$	32 ( or $\pm 16$ )	V
Differential Input Voltage	$V_{ID}$	32	V
Input Voltage	$V_{IC}$	-0.3~+32	V
Power Dissipation	$P_D$	( DIP8 ) 500 ( DMP8 ) 300 ( SSOP8 ) 300 ( SIP8 ) 800	mW
Operating Temperature Range	$T_{opr}$	-40~+85	°C
Storage Temperature Range	$T_{stg}$	-50~+125	°C

## ■ ELECTRICAL CHARACTERISTICS

( Ta=25°C,  $V^+=5V$  )

PARAMETER	SYMBOL	TEST CONDITION	MIN.	TYP.	MAX.	UNIT
Input Offset Voltage	$V_{IO}$	$R_S=0\Omega$	-	2	7	mV
Input Offset Current	$I_{IO}$		-	5	50	nA
Input Bias Current	$I_B$		-	25	250	nA
Large Signal Voltage Gain	$A_V$	$R_L \geq 2k\Omega$	-	100	-	dB
Maximum Output Voltage Swing	$V_{OM}$	$R_L=2k\Omega$	3.5	-	-	V
Input Common Mode Voltage Range	$V_{ICM}$		0~3.5	-	-	V
Common Mode Rejection Ratio	CMR		-	85	-	dB
Supply Voltage Rejection Ratio	SVR		-	100	-	dB
Output Source Current	$I_{SOURCE}$	$V_{IN}^+=1V, V_{IN}^-=0V$	20	30	-	mA
Output Sink Current	$I_{SINK}$	$V_{IN}^+=0V, V_{IN}^-=1V$	8	20	-	mA
Channel Separation	CS	$f=1k\sim 20kHz, \text{Input Referred}$	-	120	-	dB
Operating Current	$I_{CC}$	$R_L=\infty$	-	0.7	1.2	mA
Slew Rate	SR	$V^+/V^-=\pm 15V$	-	0.5	-	V/ $\mu s$
Unity Gain Bandwidth	$f_T$	$V^+/V^-=\pm 15V$	-	0.2	-	MHz

## ■ TYPICAL CHARACTERISTICS

**Operating Current vs. Operating Voltage**

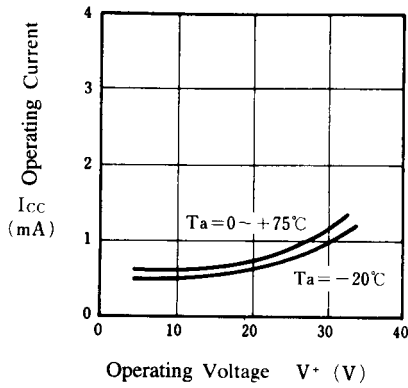

**Input Bias Current vs. Operating Voltage**

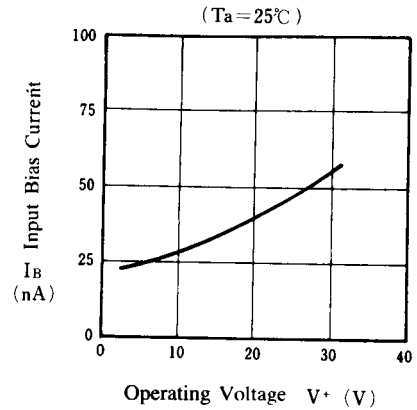

**Channel Separation vs. Frequency**

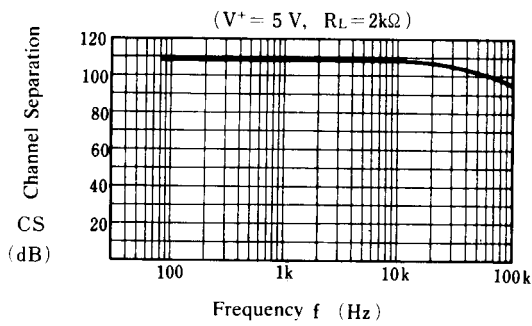

**Voltage Gain vs. Operating Voltage**

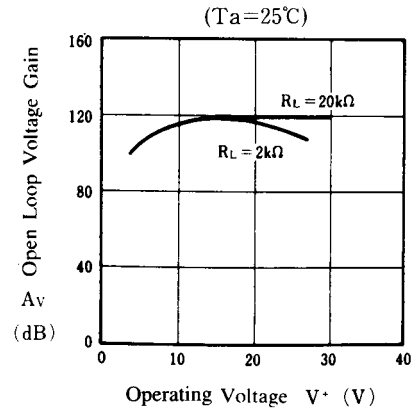

**Maximum Output Voltage Swing vs. Frequency**

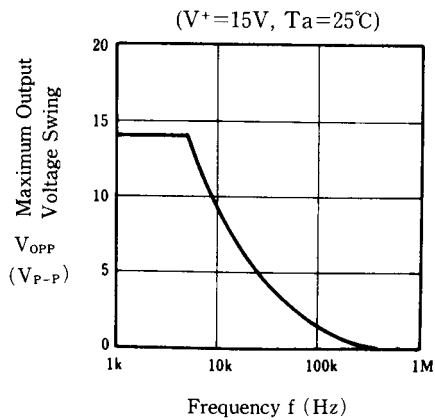

**Open Loop Voltage Gain vs. Frequency**

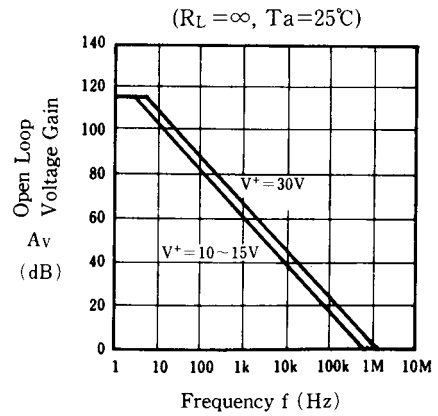

## ■ TYPICAL CHARACTERISTICS

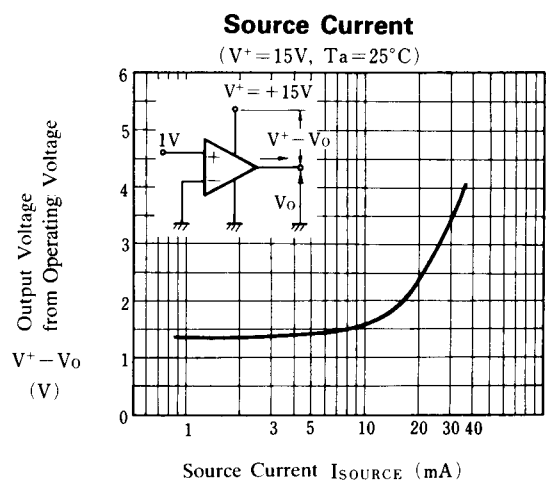
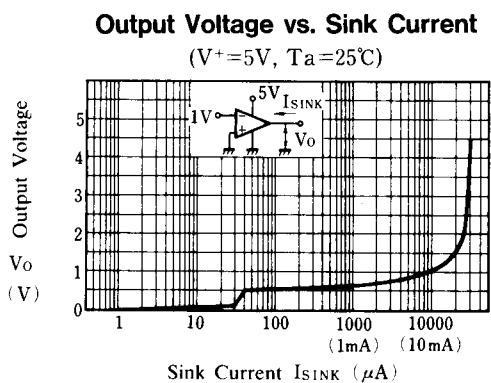
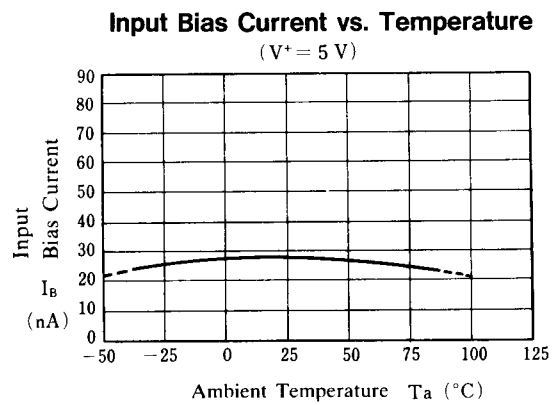
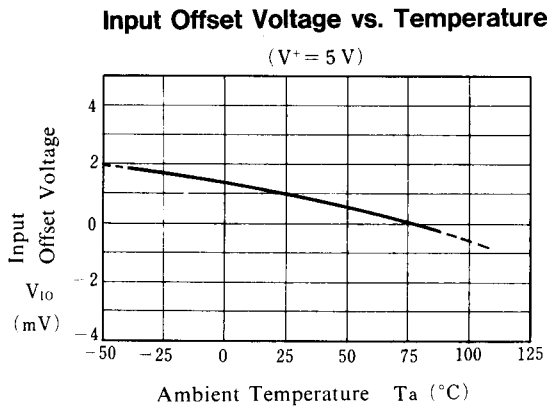
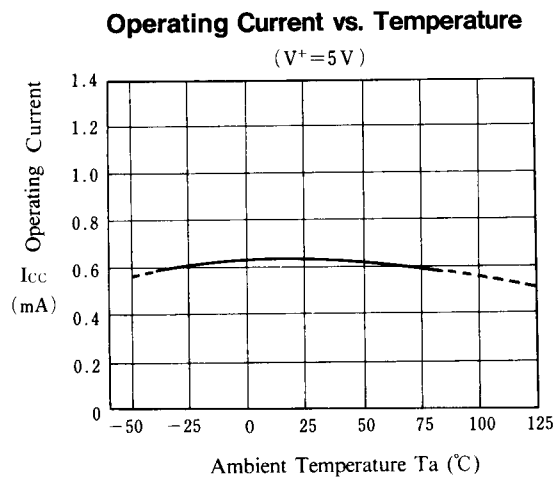
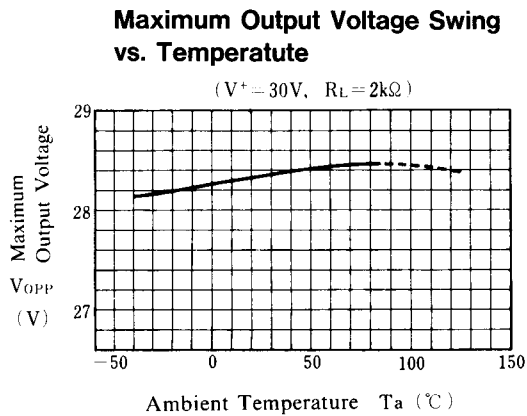

## ■ TYPICAL CHARACTERISTICS

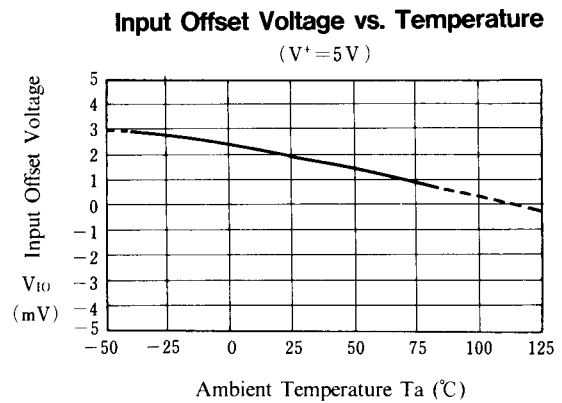
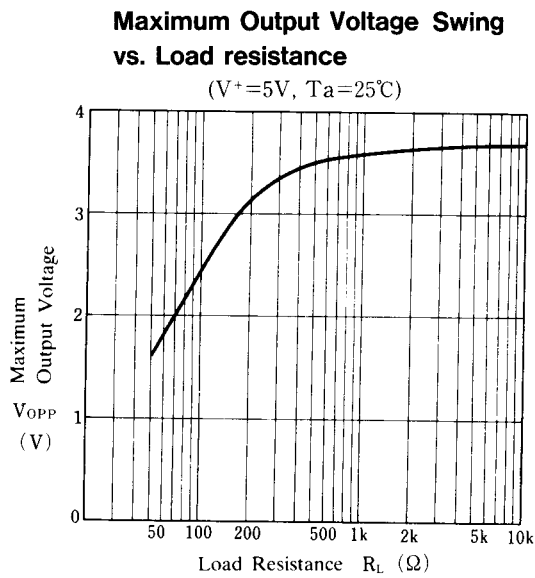
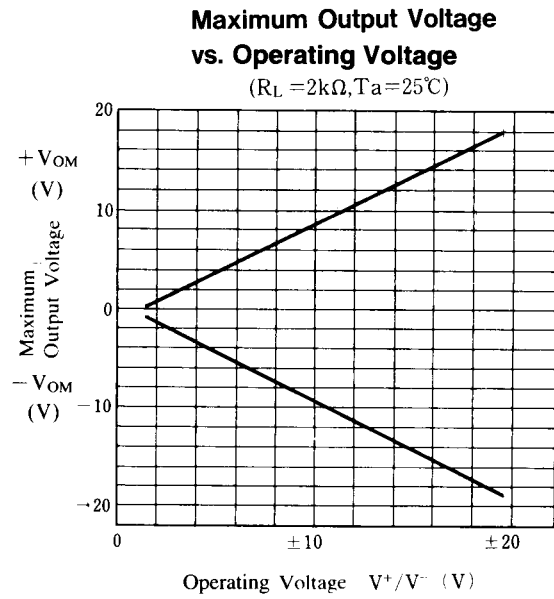
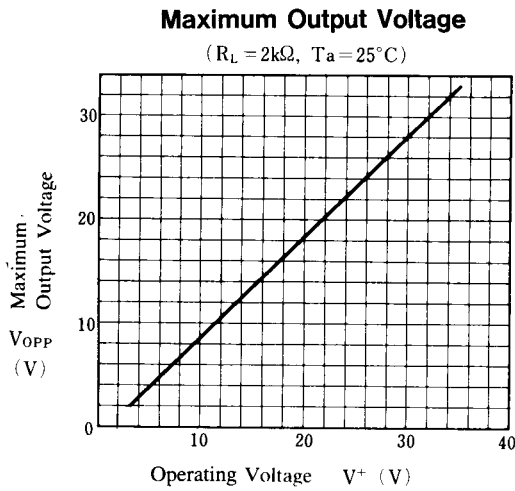

## APPLICATION

### Improvement of Cross-over Distortion

Equivalent circuit at the output stage

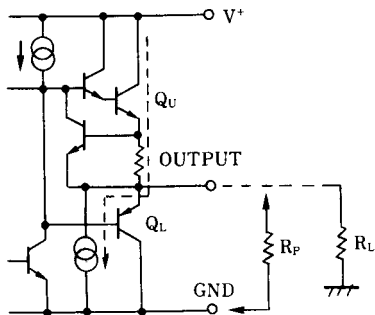

NJM2904, in its static state ( No in and output condition ) when design,  $Q_U$  being biased by constant current ( break down beam ) yet,  $Q_L$  stays OFF.

While using with both power source mode, the cross-over distortion might occur instantly when  $Q_L$  ON.

There might be cases when application for amplifier of audio signals, not only distortion but also the apparent frequency bandwidth being narrowed remarkably.

It is adjustable especially when using both power source mode, constantly to use with higher current on  $Q_U$  than the load current ( including feedback current ), and then connect the pull-down resistor  $R_P$  at the part between output and GND pins.

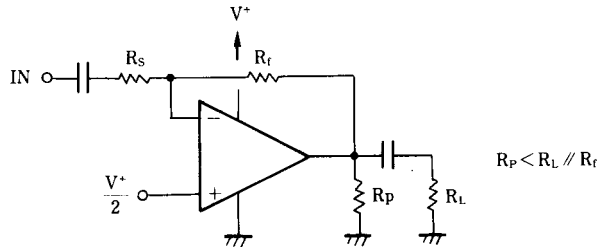
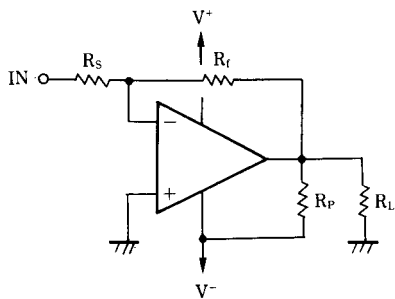

[CAUTION]  
The specifications on this databook are only given for information, without any guarantee as regards either mistakes or omissions. The application circuits in this databook are described only to show representative usages of the product and not intended for the guarantee or permission of any right including the industrial rights.