

## LOW-VOLTAGE OPERATION TINY SINGLE C-MOS OPERATIONAL AMPLIFIER

### ■ GENERAL DESCRIPTION

The NJU7017 is a low voltage single-power-supply and low operating current single C-MOS operational amplifier.

The input bias current is as low as less than 1pA, consequently the very small signal around the ground level can be amplified.

The minimum operating voltage is 1V and the output stage permits output signals to swing between both of the supply rails.

Furthermore, the NJU7017 is packaged with very small MTP-5, therefore it can be especially applied to portable items.

### ■ PACKAGE OUTLINE



NJU7017F

### ■ FEATURES

- Single-Power-Supply
- Wide Operating Voltage ( $V_{DD}=1\sim 5.5V$ )
- Wide Output Swing Range ( $V_{OM}=2.9V$  min. @ 3.0V)
- Low Operating Current ( $I_{DD}=0.75mA$  typ.)
- Low Bias Current ( $I_B=1pA$  typ.)
- Compensation Capacitor Incorporated
- C-MOS Technology
- Package Outline MTP5

### ■ PIN CONFIGURATION

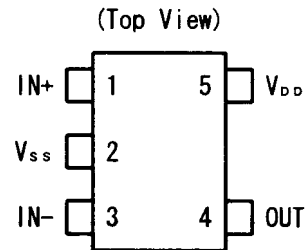

### ■ EQUIVALENT CIRCUIT

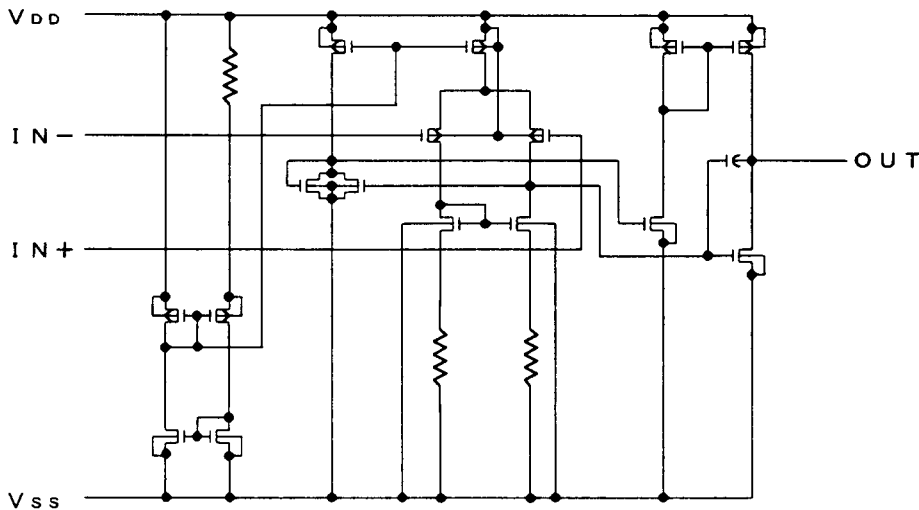

# NJU7017

## ■ ABSOLUTE MAXIMUM RATINGS

( Ta=25°C )

PARAMETER	SYMBOL	RATINGS	UNIT
Supply Voltage	V <sub>DD</sub>	7	V
Differential Input Voltage	V <sub>ID</sub>	± 7 ( note1 )	V
Common Mode Input Voltage	V <sub>IC</sub>	-0.3~7	V
Power Dissipation	P <sub>D</sub>	200	mW
Operating Temperature Range	T <sub>opr</sub>	-40~+85	°C
Storage Temperature Range	T <sub>stg</sub>	-55~+125	°C

( note1 ) If the supply voltage ( V<sub>DD</sub> ) is less than 7V, the input voltage must not over the V<sub>DD</sub> level though 7V is limit specified.

( note2 ) Decoupling capacitor should be connected between V<sub>DD</sub> and V<sub>SS</sub> for the stable operation.

## ■ ELECTRICAL CHARACTERISTICS

( Ta=25°C, V<sub>DD</sub>=3.0V, R<sub>L</sub>=∞ )

PARAMETER	SYMBOL	TEST CONDITION	MIN.	TYP.	MAX.	UNIT
Input Offset Voltage	V <sub>IO</sub>	V <sub>IN</sub> =1/2V <sub>DD</sub>	-	-	10	mV
Input Offset Current	I <sub>IO</sub>		-	1	-	pA
Input Bias Current	I <sub>IB</sub>		-	1	-	pA
Input Impedance	R <sub>IN</sub>		-	1	-	TΩ
Large Signal Voltage Gain	A <sub>VD</sub>		60	70	-	dB
Input Common Mode Voltage Range	V <sub>ICM</sub>		0~2.5	-	-	V
Maximum Output Swing Voltage	V <sub>OM1</sub>	R <sub>L</sub> =16kΩ	V <sub>DD</sub> -0.1	-	-	V
	V <sub>OM2</sub>	R <sub>L</sub> =16kΩ	-	-	V <sub>SS</sub> +0.1	V
Common Mode Rejection Ratio	CMR	V <sub>IN</sub> =1/2V <sub>DD</sub>	55	65	-	dB
Supply Voltage Rejection Ratio	SVR	V <sub>DD</sub> =1.5~5.5V	60	70	-	dB
Operating Current	I <sub>DD</sub>		-	0.75	1.5	mA
Slew Rate	SR		-	3.7	-	V/μs
Unity Gain Bandwidth	F <sub>t</sub>	A <sub>V</sub> =40dB, C <sub>L</sub> =10pF	-	1.0	-	MHz

( note3 ) The source current is less than 181μA ( at V<sub>OM</sub>/R<sub>L</sub>=2.9V/16kΩ ).

## ■ TYPICAL CHARACTERISTICS

Output Voltage vs. Output Current (SOURCE)

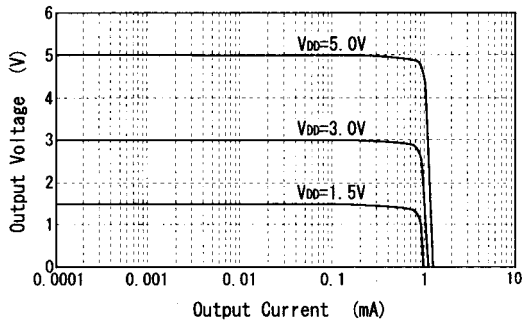

Offset Voltage vs. Operating Voltage  
V<sub>IN</sub>=0.1V

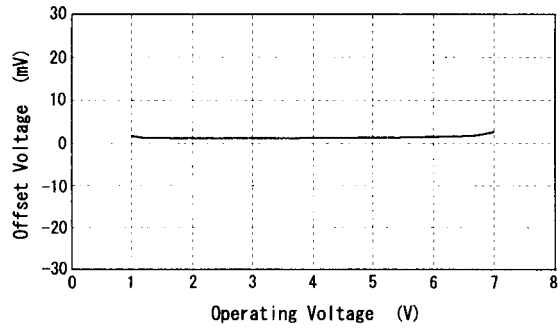

Operating Current vs. Operating Voltage  
V<sub>IN</sub>=0.1V

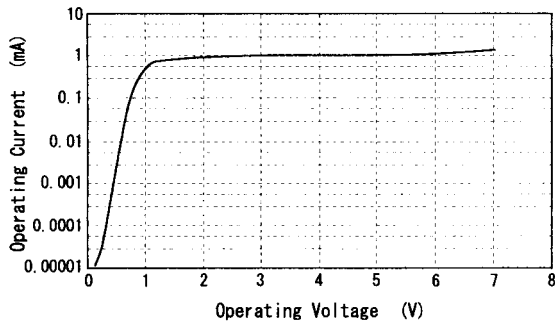

Output Current vs. Operating Voltage  
V<sub>IN</sub>=0.1V

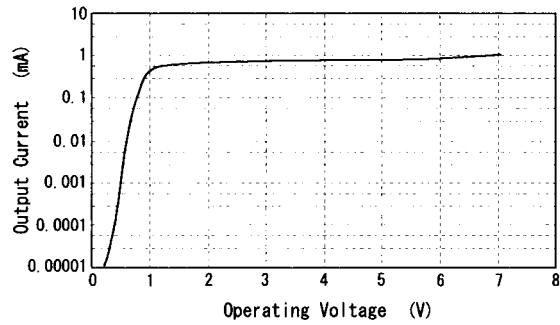

Maximum Output Swing Voltage vs. Load Resistance

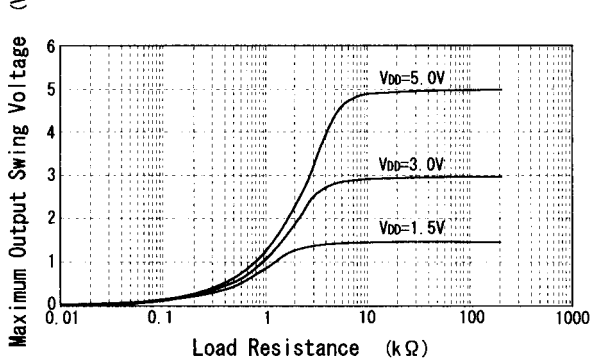

Maximum Output Swing Voltage vs. Frequency

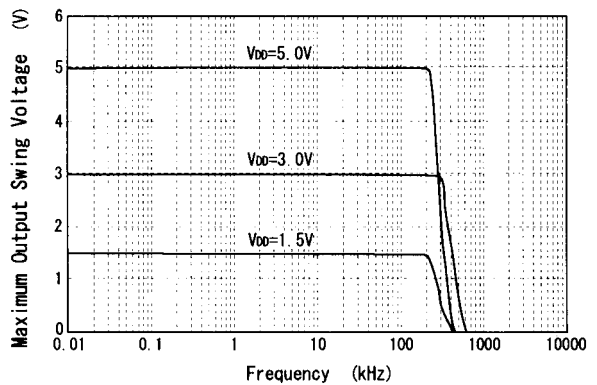

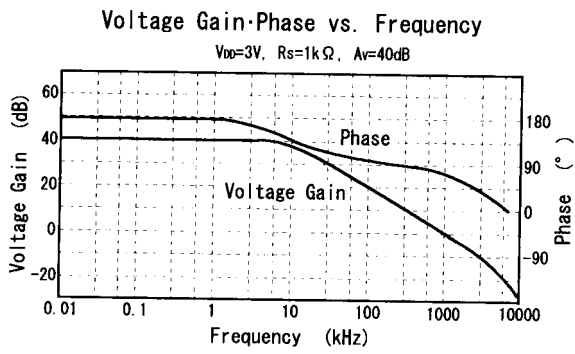

[CAUTION]

The specifications on this databook are only given for information, without any guarantee as regards either mistakes or omissions. The application circuits in this databook are described only to show representative usages of the product and not intended for the guarantee or permission of any right including the industrial rights.