

## ADJUSTABLE PRECISION SHUNT REGULATOR

### ■ GENERAL DESCRIPTION

The NJM431 is a 3 terminal adjustable shunt regulator. The output voltage may be set to any value between  $V_{REF}$  (about 2.5V) and 36V by two resistors. Output circuitry shows a sharp turn-on characteristics. Applications include shunt regulators, series regulators for small power and isolation regulators with photo couplers.

### ■ FEATURES

- Operating Voltage ( $V_{KA} = V_{REF}$  to 36V)
- Fast Turn-On Respability
- Cathode Current (1mA to 100mA)
- Low Dynamic Output Impedance (0.2Ωtyp.)
- Load Regulation typically (0.1%)
- Package Outline DIP8, DMP8, TO-92, SOT-89
- Bipolar Technology

### ■ PIN CONFIGURATION

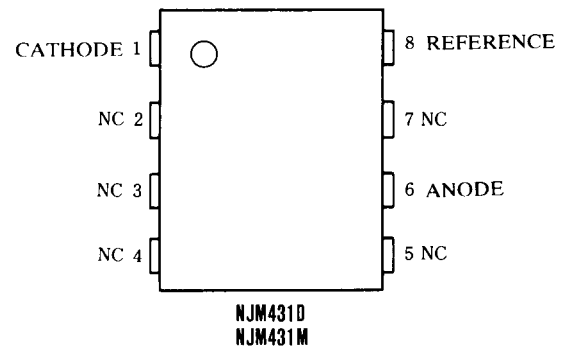
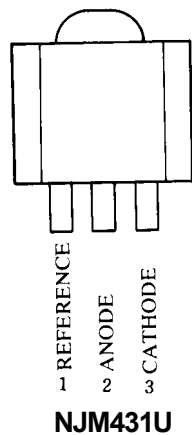
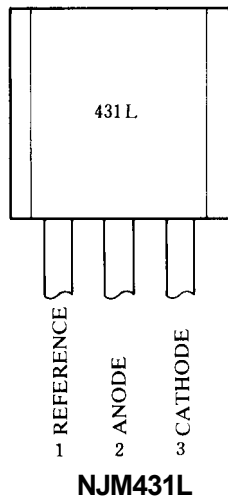

### ■ EQUIVALENT CIRCUIT

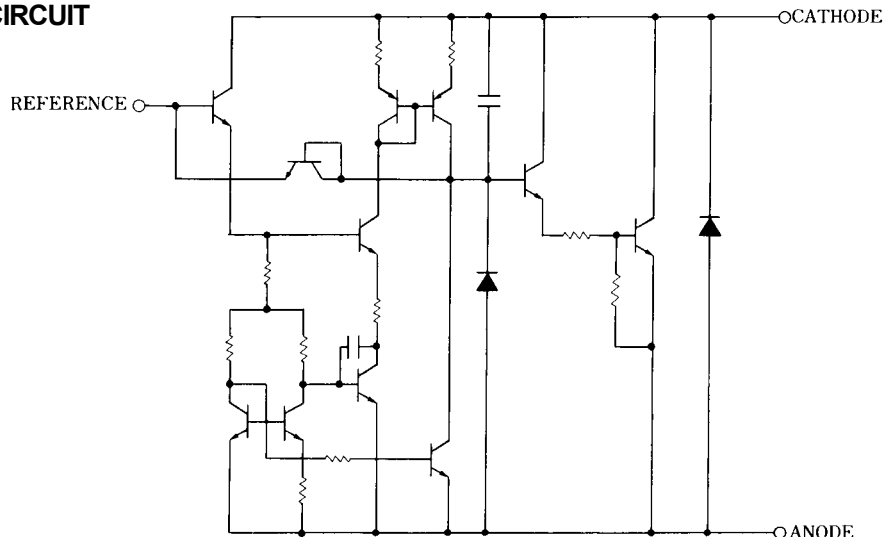

### ■ PACKAGE OUTLINE

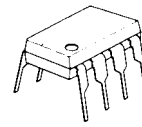

**NJM431D**

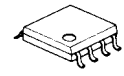

**NJM431M**

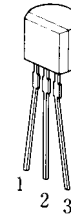

**NJM431L(TO-92)**

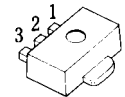

1. REF
2. ANODE
3. CATHODE

**NJM431U(SOT-89)**

# NJM431

## ■ BLOCK DIAGRAM

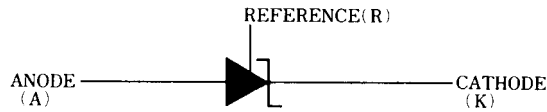

## ■ ABSOLUTE MAXIMUM RATINGS

( $T_a=25^\circ\text{C}$ )

PARAMETER	SYMBOL	RATINGS	UNIT
Cathode Voltage (note)	$V_{KA}$	37	V
Continuous Cathode Current	$I_{KA}$	-100 to 150	mA
Reference Input Current	$I_{REF}$	-0.05 to 10	mA
Power Dissipation	$P_D$	(DIP8) 700 (DMP8) 300 (TO92) 500 (SOT89) 350	mW mW mW mW
Operating Temperature	$T_{opr}$	-40 to +85	$^\circ\text{C}$
Storage Temperature Range	$T_{stg}$	-40 to +125	$^\circ\text{C}$

(note) Unless specified, all voltage value are with respect to the anode terminal.

## ■ RECOMMENDED OPERATING CONDITIONS

PARAMETER	SYMBOL	MIN.	TYP.	MAX.	UNIT
Cathode Voltage	$V_{KA}$	$V_{REF}$	-	36	V
Cathode Current	$I_K$	1	-	100	mA

## ■ ELECTRICAL CHARACTERISTICS ( $T_a=25^\circ\text{C}$ )

PARAMETER	SYMBOL	TEST CONDITION	MIN.	TYP.	MAX.	UNIT	
Reference Voltage	$V_{REF}$	$V_{KA} = V_{REF}$ , $I_K = 10\text{mA}$ (note 1)	2440	2495	2550	mV	
Reference Voltage Change (Full Oper. Temp. Range)	$V_{REF}$ (dev)	$V_{KA} = V_{REF}$ , $I_K = 10\text{mA}$ (note 1) $T_a = -20^\circ\text{C}$ to $+85^\circ\text{C}$	-	8	17	mV	
Reference Voltage Change vs. Cathode Voltage Change	$\frac{\Delta V_{REF}}{\Delta V_{KA}}$	$I_K = 10\text{mA}$ (note 2)	$\Delta V_{KA} = 10\text{V} - V_{REF}$	-	-1.4	-2.7	mV/V
	$\Delta V_{KA} = 36\text{V} - 10\text{V}$		-	-1	-2	mV/V	
Reference Input Current	$I_{REF}$	$I_K = 10\text{mA}$ , $R_1 = 10\text{k}\Omega$ , $R_2 = \infty$ (note 2)	-	2	4	$\mu\text{A}$	
Reference Input Current Change (Full Oper. Temp. Range)	$I_{REF}$ (dev)	$I_K = 10\text{mA}$ , $R_1 = 10\text{k}\Omega$ , $R_2 = \infty$ (note 2) $T_a = -20^\circ\text{C}$ to $+85^\circ\text{C}$	-	0.4	1.2	$\mu\text{A}$	
Minimum Input Current	$I_{MIN}$	$V_{KA} = V_{REF}$ (note 1)	-	0.4	1.0	mA	
Cathode Current (Off Cond.)	$I_{OFF}$	$V_{KA} = 36\text{V}$ , $V_{REF} = 0$ (note 3)	-	0.1	1.0	$\mu\text{A}$	
Dynamic Impedance	$ Z_{KA} $	$V_{KA} = V_{REF}$ , $I_K = 1\text{mA}$ to $100\text{mA}$ , $f \leq 1\text{kHz}$ (note 1)	-	0.2	0.5	$\Omega$	

(note 1) TEST CIRCUIT (Fig. 1)

(note 2) TEST CIRCUIT (Fig. 2)

(note 3) TEST CIRCUIT (Fig. 3)

## TEST CIRCUITS

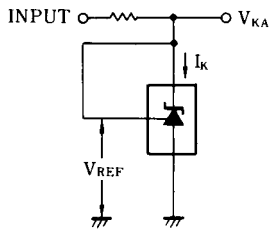

1.  $V_{KA} = V_{REF}$   
 $V_O = V_{KA} = V_{REF}$

(Fig. 1)

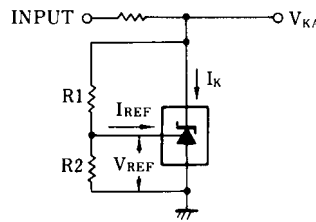

2.  $V_{KA} > V_{REF}$   
 $V_O = V_{KA} = V_{REF} \left(1 + \frac{R1}{R2}\right) + I_{REF} \cdot R1$

(Fig. 2)

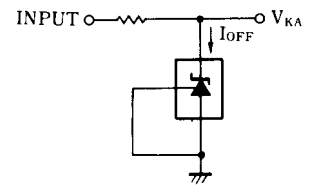

3.  $I_{OFF}$

(Fig. 3)

## TYPICAL APPLICATION

### (1) Shunt Regulator

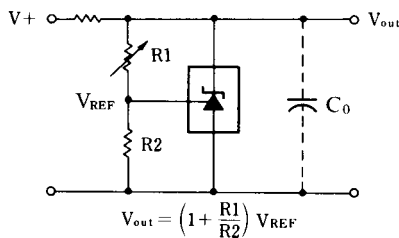

### (3) Output Control of a Three-Terminal fixed Regulator

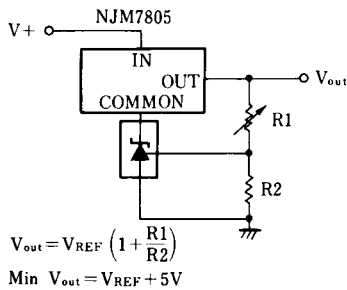

### (2) Series Regulator

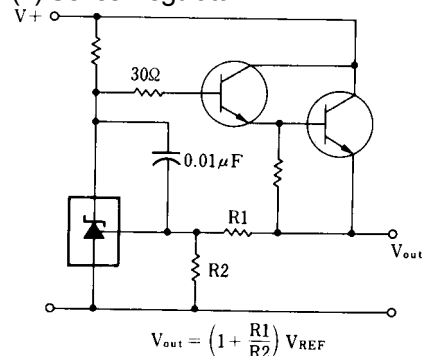

### (4) Constant Current Source

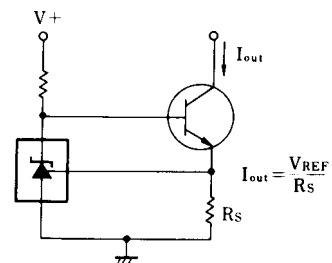

## POWER DISSIPATION VS. AMBIENT TEMPERATURE

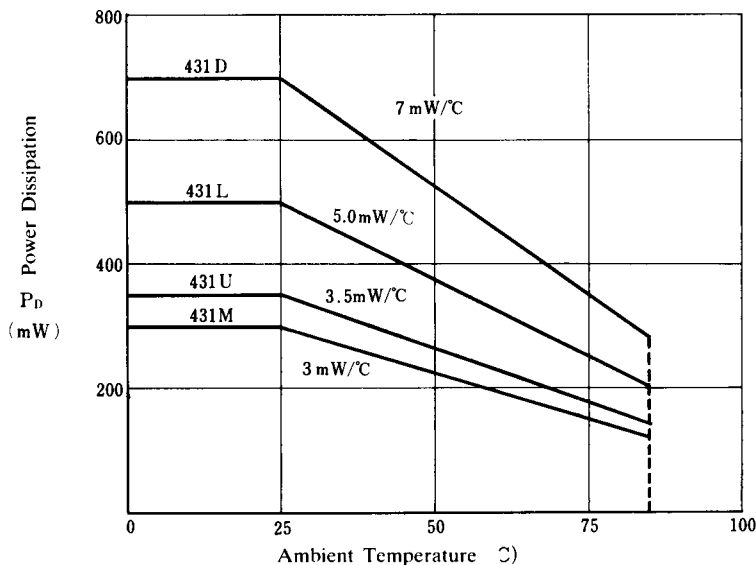

## TYPICAL CHARACTERISTICS

### Reference Voltage

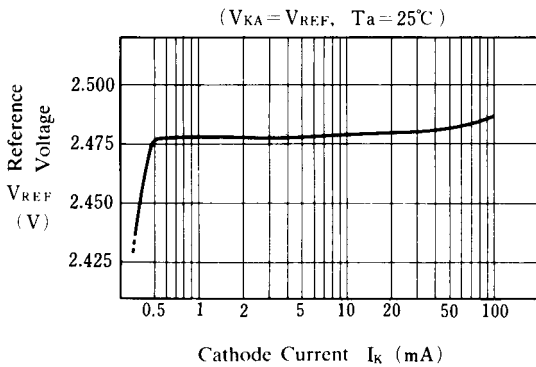

### Reference Voltage

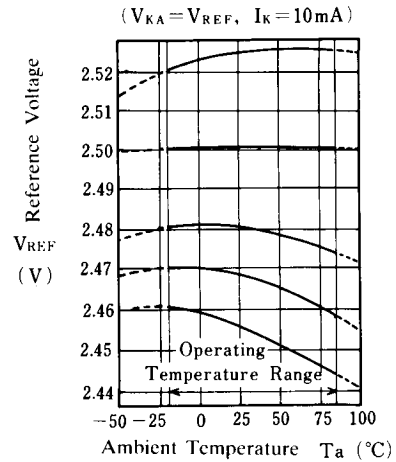

### Reference Input Current

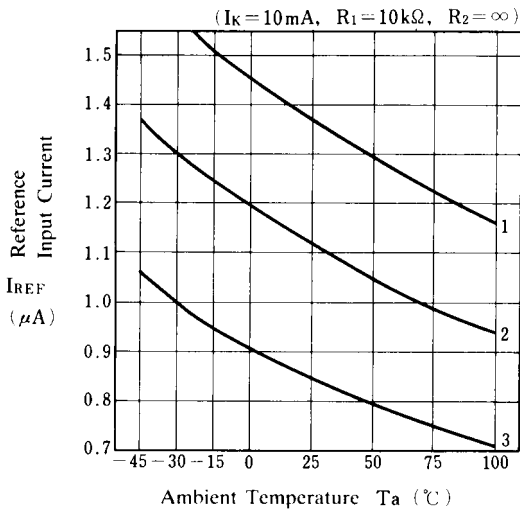

$V_{REF}(\text{dev})$	( $T_a = -20 \text{ to } 25^\circ\text{C}$ )	( $T_a = 25 \text{ to } 85^\circ\text{C}$ )	( $T_a = 25^\circ\text{C}$ )
No. 1	+5mV	+1mV	2525mV
No. 2	0mV	0mV	2501mV
No. 3	0mV	-6mV	2481mV
No. 4	-2mV	-9mV	2468mV
No. 5	-5mV	-12mV	2456mV

$I_{REF}(\text{dev})$

- No.1  $-0.38\mu\text{A}$
- No.2  $-0.27\mu\text{A}$
- No.3  $-0.21\mu\text{A}$

### Reference Voltage

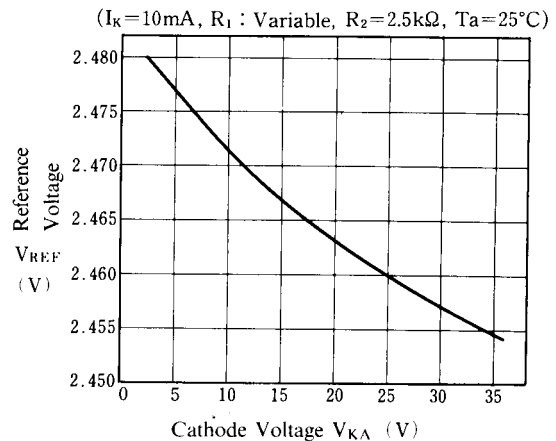

### Safety Operating Boundary Condition

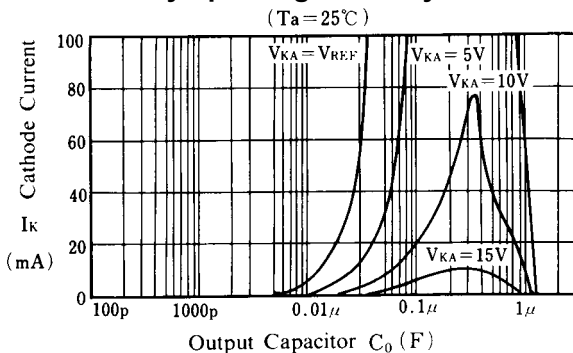

### Dynamic Impedance

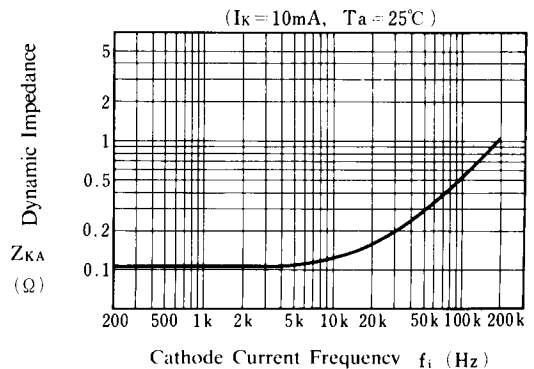

Note) Oscillation might occur while operating within the range of safety curve. So that, it is necessary to make ample margins by taking considerations of fluctuation of the device.

**[CAUTION]**

The specifications on this databook are only given for information, without any guarantee as regards either mistakes or omissions. The application circuits in this databook are described only to show representative usages of the product and not intended for the guarantee or permission of any right including the industrial rights.