

## C-MOS STEP-UP SWITCHING REGULATOR

### ■ GENERAL DESCRIPTION

The **NJU7261 series** is a C-MOS step-up switching regulator which contains accurate voltage reference, error amplifier, CR oscillator, control circuit, switching transistor, diode and resistor.

The stand-by function is effective for low power consumption.

The regulation voltage is fixed by internal circuits and the following line-up of different output voltages version are available.

This series is suitable for portable equipment's or battery operated items because of its small packaged outline, low operating voltage and current.

### ■ FEATURES

- Low Operating Voltage (1.0V min.)
- Low Operating Current (5.0 $\mu$ A typ. /  $V_{OUT} = 3.0V$ )
- Low Stand-by Current (0.2 $\mu$ A max. /  $V_{OUT} = 3.0V$ )
- High Precision Output Voltage ( $\pm 3\%$  max.)
- Wide Operating Voltage Range
- Stand-by Function
- CR Oscillator On-chip
- Diode On-chip
- Package Outline SOT89-5
- C-MOS Technology

### ■ LINE-UP

Output Voltage (V)	Line-Up
3.0	NJU7261U30
3.3	NJU7261U33
4.5	NJU7261U45
5.0	NJU7261U50

### ■ TERMINAL DESCRIPTION

No.	Term. Name	I/O	FUNCTION
1	CONT	I	External Inductor Connect Terminal
2	GND	POWER	Power Source (GND)
3	STB	I	Strobe Terminal : "H" or OPEN...Normal Operation (step-up) " L" ...Standp-By Operation
4	$V_{IN}$	POWER	Power Source (+)
5	$V_{OUT}$	O	Step-up Output Terminal

### ■ PACKAGE OUTLINE

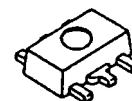

NJU7261UX

### ■ PIN CONFIGURATION

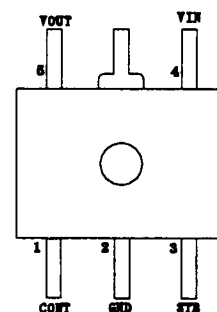

### ■ EQUIVALENT CIRCUIT

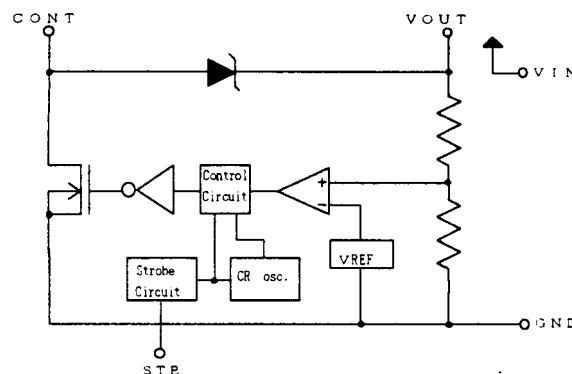

# NJU7261 Series

## ■ ABSOLUTE MAXIMUM RATINGS

(T<sub>a</sub> = 25°C)

PARAMETER	SYMBOL	RATINGS	UNIT
Input Voltage	V <sub>IN</sub>	10	V
CONT Input Voltage	V <sub>CONT</sub>	GND-0.3 ≤ V <sub>CONT</sub> ≤ 10	V
Strobe Input Voltage	V <sub>STB</sub>	GND-0.3 ≤ V <sub>STB</sub> ≤ V <sub>IN</sub>	V
Output Voltage	V <sub>OUT</sub>	GND-0.3 ≤ V <sub>OUT</sub> ≤ 10	V
Power Dissipation	P <sub>D</sub>	300	mW
Operating Temperature Range	T <sub>opr</sub>	-25 to + 75	°C
Storage Temperature Range	T <sub>stg</sub>	-40 to +125	°C

Note1) When a coil used. This IC of V<sub>CONT</sub> possible over the absolute maximum ratings. Consequently please conduct enough to test.

Note2) The CONT input voltage (V<sub>CONT</sub>) should be inspected at the real application circuit, as some kinds of coils make the CONT input voltage exceed the Absolute Maximum Rating of the V<sub>CONT</sub>.

## ■ ELECTRICAL CHARACTERISTICS

+3.0V Version

(T<sub>a</sub> = 25°C)

PARAMETER	SYMBOL		CONDITION	NORM			UNIT	MEASUREMENT CIRCUIT
				MIN.	TYP.	MAX.		
Input Voltage	V <sub>IN</sub>			-	-	5.0	V	1
Start Voltage	V <sub>START</sub>		NO LOAD	-	-	1.0	V	1
Oscillator Freq.	f <sub>OSC</sub>		V <sub>IN</sub> = 1.5V	20	30	50	kHz	2
Output Voltage	V <sub>OUT</sub>		V <sub>IN</sub> = 1.5V, I <sub>OUT</sub> = 20mA	2.91	3.0	3.09	V	1
Input Stability	ΔV <sub>OUT1</sub>		V <sub>IN</sub> = 1.5V to 2.0V I <sub>OUT</sub> = 20mA	-	30	100	mV	1
Load Stability	ΔV <sub>OUT2</sub>		V <sub>IN</sub> = 1.5V I <sub>OUT</sub> = 10μA to 25mA	-	30	100	mV	1
Operating Current	I <sub>SS</sub>		V <sub>IN</sub> = V <sub>STB</sub> = 1.5V, NO LOAD	-	5.0	10	μA	3
Stand-by Current	I <sub>Q</sub>		V <sub>IN</sub> = 1.5V V <sub>STB</sub> = 0V, NO LOAD	-	-	0.2	μA	4
Switching Current	I <sub>SI</sub>		V <sub>DS</sub> = 0.2V	-	250	-	mA	-
STB Terminal Input Voltage	H level	V <sub>STBH</sub>	V <sub>IN</sub> = 1.5V	1.0	-	-	V	5
	L level	V <sub>STBL</sub>	V <sub>IN</sub> = 1.5V	-	-	0.4	V	5
STB Terminal Input Current	H level	I <sub>STBH1</sub>	V <sub>IN</sub> = 1.5V, V <sub>STB</sub> = 1.0V	-	15	30	μA	6
		I <sub>STBH2</sub>	V <sub>IN</sub> = 1.5V, V <sub>STB</sub> = 1.5V	-	0.1	-	μA	6
	L level	I <sub>STBL1</sub>	V <sub>IN</sub> = 1.5V, V <sub>STB</sub> = 0.4V	-	15	30	μA	6
		I <sub>STBL2</sub>	V <sub>IN</sub> = 1.5V, V <sub>STB</sub> = 0V	-	0.1	-	μA	6

# NJU7261 Series

+3.3V Version

(T<sub>a</sub> = 25°C)

PARAMETER	SYMBOL		CONDITION	NORM			UNIT	MEASUREMENT CIRCUIT
				MIN.	TYP.	MAX.		
Input Voltage	V <sub>IN</sub>			-	-	5.0	V	1
Start Voltage	V <sub>START</sub>		NO LOAD	-	-	1.0	V	1
Oscillator Freq.	f <sub>OSC</sub>		V <sub>IN</sub> = 1.5V	20	30	50	kHz	2
Output Voltage	V <sub>OUT</sub>		V <sub>IN</sub> = 1.5V, I <sub>OUT</sub> = 20mA	3.20	3.30	3.40	V	1
Input Stability	ΔV <sub>OUT1</sub>		V <sub>IN</sub> = 1.5V to 3.0V I <sub>OUT</sub> = 20mA	-	30	100	mV	1
Load Stability	ΔV <sub>OUT2</sub>		V <sub>IN</sub> = 1.5V I <sub>OUT</sub> = 10μA to 25mA	-	30	100	mV	1
Operating Current	I <sub>SS</sub>		V <sub>IN</sub> = V <sub>STB</sub> = 1.5V, NO LOAD	-	5	10	μA	3
Stand-by Current	I <sub>Q</sub>		V <sub>IN</sub> = 1.5V V <sub>STB</sub> = 0V, NO LOAD	-	-	0.2	μA	4
Switching Current	I <sub>SI</sub>		V <sub>DS</sub> = 0.2V	-	250	-	mA	-
STB Terminal Input Voltage	H level	V <sub>STBH</sub>	V <sub>IN</sub> = 1.5V	1.0	-	-	V	5
	L level	V <sub>STBL</sub>	V <sub>IN</sub> = 1.5V	-	-	0.4	V	5
STB Terminal Input Current	H level	I <sub>STBH1</sub>	V <sub>IN</sub> = 1.5V, V <sub>STB</sub> = 1.0V	-	15	30	μA	6
		I <sub>STBH2</sub>	V <sub>IN</sub> = 1.5V, V <sub>STB</sub> = 1.5V	-	0.1	-	μA	6
	L level	I <sub>STBL1</sub>	V <sub>IN</sub> = 1.5V, V <sub>STB</sub> = 0.4V	-	15	30	μA	6
		I <sub>STBL2</sub>	V <sub>IN</sub> = 1.5V, V <sub>STB</sub> = 0V	-	0.1	-	μA	6

+4.5V Version

(T<sub>a</sub> = 25°C)

PARAMETER	SYMBOL		CONDITION	NORM			UNIT	MEASUREMENT CIRCUIT
				MIN.	TYP.	MAX.		
Input Voltage	V <sub>IN</sub>			-	-	4.5	V	1
Start Voltage	V <sub>START</sub>		NO LOAD	-	-	1.0	V	1
Oscillator Freq.	f <sub>OSC</sub>		V <sub>IN</sub> = 3.0V	20	30	50	kHz	2
Output Voltage	V <sub>OUT</sub>		V <sub>IN</sub> = 3.0V, I <sub>OUT</sub> = 20mA	4.36	4.50	4.64	V	1
Input Stability	ΔV <sub>OUT1</sub>		V <sub>IN</sub> = 2.0V to 3.0V I <sub>OUT</sub> = 20mA	-	30	100	mV	1
Load Stability	ΔV <sub>OUT2</sub>		V <sub>IN</sub> = 3.0V I <sub>OUT</sub> = 10μA to 25mA	-	30	100	mV	1
Operating Current	I <sub>SS</sub>		V <sub>IN</sub> = V <sub>STB</sub> = 3.0V, NO LOAD	-	5	15	μA	3
Stand-by Current	I <sub>Q</sub>		V <sub>IN</sub> = 3.0V V <sub>STB</sub> = 0V, NO LOAD	-	-	0.2	μA	4
Switching Current	I <sub>SI</sub>		V <sub>DS</sub> = 0.2V	-	250	-	mA	-
STB Terminal Input Voltage	H level	V <sub>STBH</sub>	V <sub>IN</sub> = 3.0V	2.4	-	-	V	5
	L level	V <sub>STBL</sub>	V <sub>IN</sub> = 3.0V	-	-	0.4	V	5
STB Terminal Input Current	H level	I <sub>STBH1</sub>	V <sub>IN</sub> = 3.0V, V <sub>STB</sub> = 2.4V	-	50	100	μA	6
		I <sub>STBH2</sub>	V <sub>IN</sub> = 3.0V, V <sub>STB</sub> = 3.0V	-	0.1	-	μA	6
	L level	I <sub>STBL1</sub>	V <sub>IN</sub> = 3.0V, V <sub>STB</sub> = 0.4V	-	50	100	μA	6
		I <sub>STBL2</sub>	V <sub>IN</sub> = 3.0V, V <sub>STB</sub> = 0V	-	0.1	-	μA	6

# NJU7261 Series

+5.0V Version

(T<sub>a</sub> = 25°C)

PARAMETER	SYMBOL		CONDITION	NORM			UNIT	MEASUREMENT CIRCUIT
				MIN.	TYP.	MAX.		
Input Voltage	V <sub>IN</sub>			-	-	5.0	V	1
Start Voltage	V <sub>START</sub>		NO LOAD	-	-	1.0	V	1
Oscillator Freq.	f <sub>OSC</sub>		V <sub>IN</sub> = 3.0V	20	30	50	kHz	2
Output Voltage	V <sub>OUT</sub>		V <sub>IN</sub> = 3.0V, I <sub>OUT</sub> = 20mA	4.85	5.0	5.15	V	1
Input Stability	ΔV <sub>OUT1</sub>		V <sub>IN</sub> = 2.0V to 3.0V I <sub>OUT</sub> = 20mA	-	30	100	mV	1
Load Stability	ΔV <sub>OUT2</sub>		V <sub>IN</sub> = 3.0V I <sub>OUT</sub> = 10μA to 25mA	-	30	100	mV	1
Operating Current	I <sub>SS</sub>		V <sub>IN</sub> = V <sub>STB</sub> = 3.0V, NO LOAD	-	5	15	μA	3
Stand-by Current	I <sub>Q</sub>		V <sub>IN</sub> = 3.0V V <sub>STB</sub> = 0V, NO LOAD	-	-	0.2	μA	4
Switching Current	I <sub>SI</sub>		V <sub>DS</sub> = 0.2V	-	250	-	mA	-
STB Terminal Input Voltage	H level	V <sub>STBH</sub>	V <sub>IN</sub> = 3.0V	2.4	-	-	V	5
	L level	V <sub>STBL</sub>	V <sub>IN</sub> = 3.0V	-	-	0.4	V	5
STB Terminal Input Current	H level	I <sub>STBH1</sub>	V <sub>IN</sub> = 3.0V, V <sub>STB</sub> = 2.4V	-	50	100	μA	6
		I <sub>STBH2</sub>	V <sub>IN</sub> = 3.0V, V <sub>STB</sub> = 3.0V	-	0.1	-	μA	6
	L level	I <sub>STBL1</sub>	V <sub>IN</sub> = 3.0V, V <sub>STB</sub> = 0.4V	-	50	100	μA	6
		I <sub>STBL2</sub>	V <sub>IN</sub> = 3.0V, V <sub>STB</sub> = 0V	-	0.1	-	μA	6

■ MEASUREMENT CIRCUIT 1

(1)

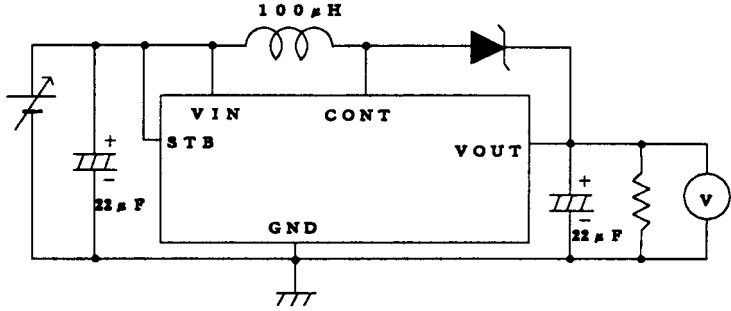

External Diode Type : "D1NS4" provided by SHINDENGEN  
( $I_F = 1A, V_F = 0.55V$ )

(2)

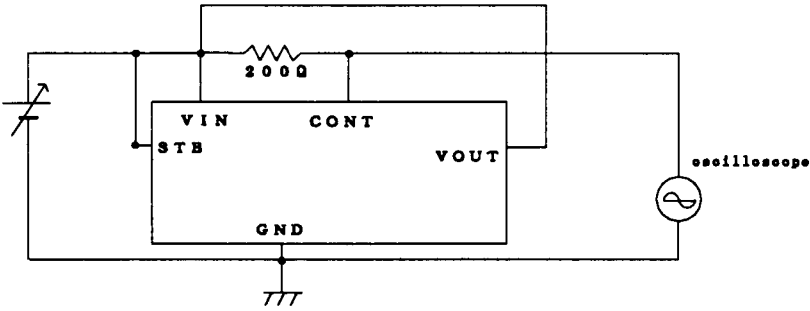

(3)

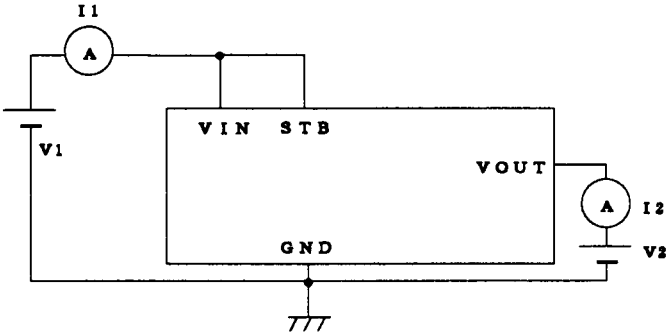

$$I_{SS} = I_1 + I_2 \times \frac{V_{OUT}}{V_2}$$

Under the condition of  $V_2 = V_{OUT} + 1.0V$

# NJU7261 Series

## MEASUREMENT CIRCUIT 2

(4)

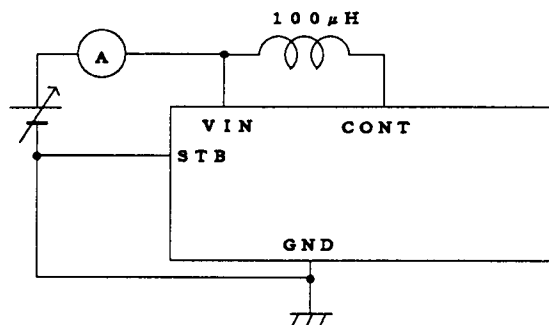

(5)

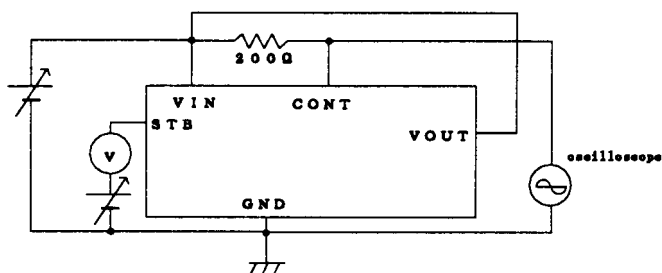

(6)

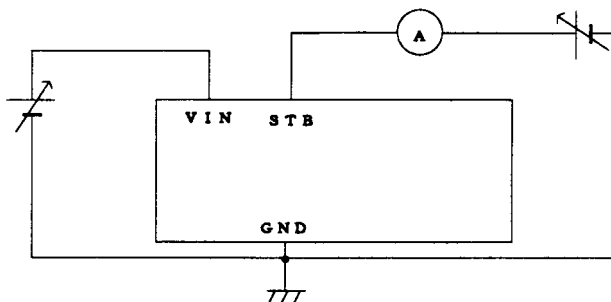

■ APPLICATION CIRCUIT

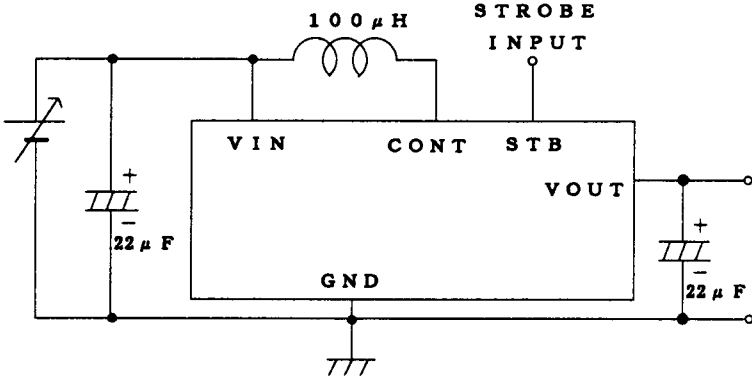

# NJU7261 Series

## ■ TYPICAL CHARACTERISTIC

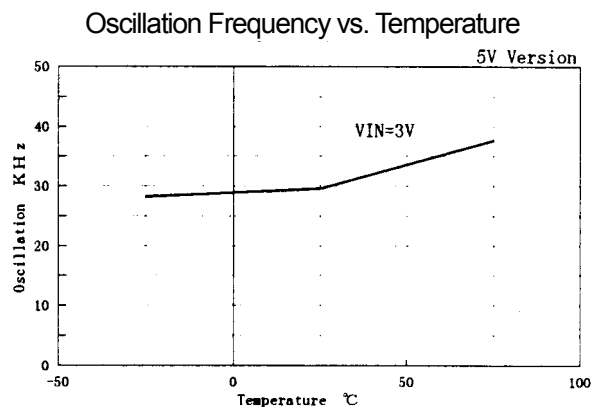
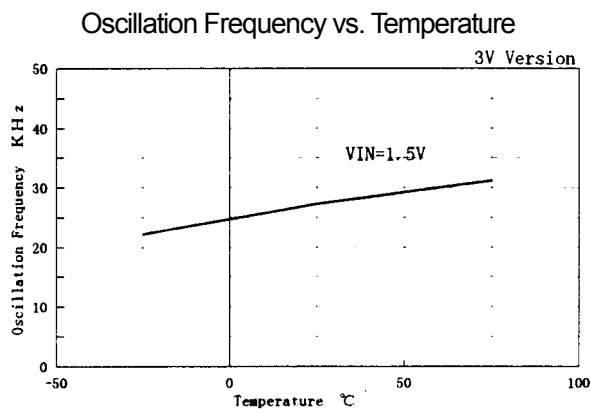
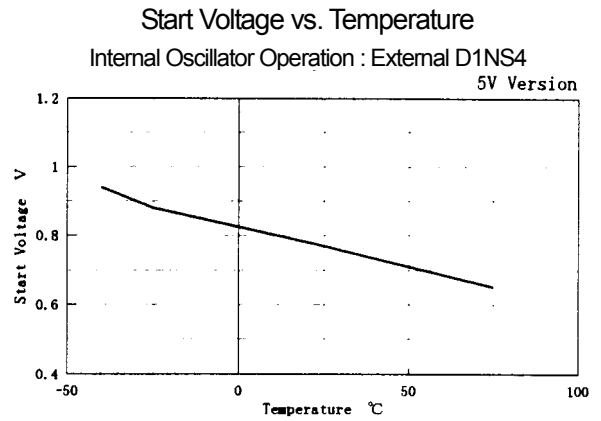
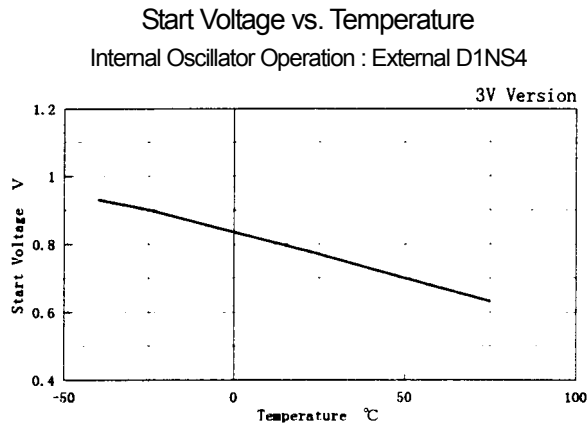

**[CAUTION]**

The specifications on this databook are only given for information, without any guarantee as regards either mistakes or omissions. The application circuits in this databook are described only to show representative usages of the product and not intended for the guarantee or permission of any right including the industrial rights.