

## SDIP24

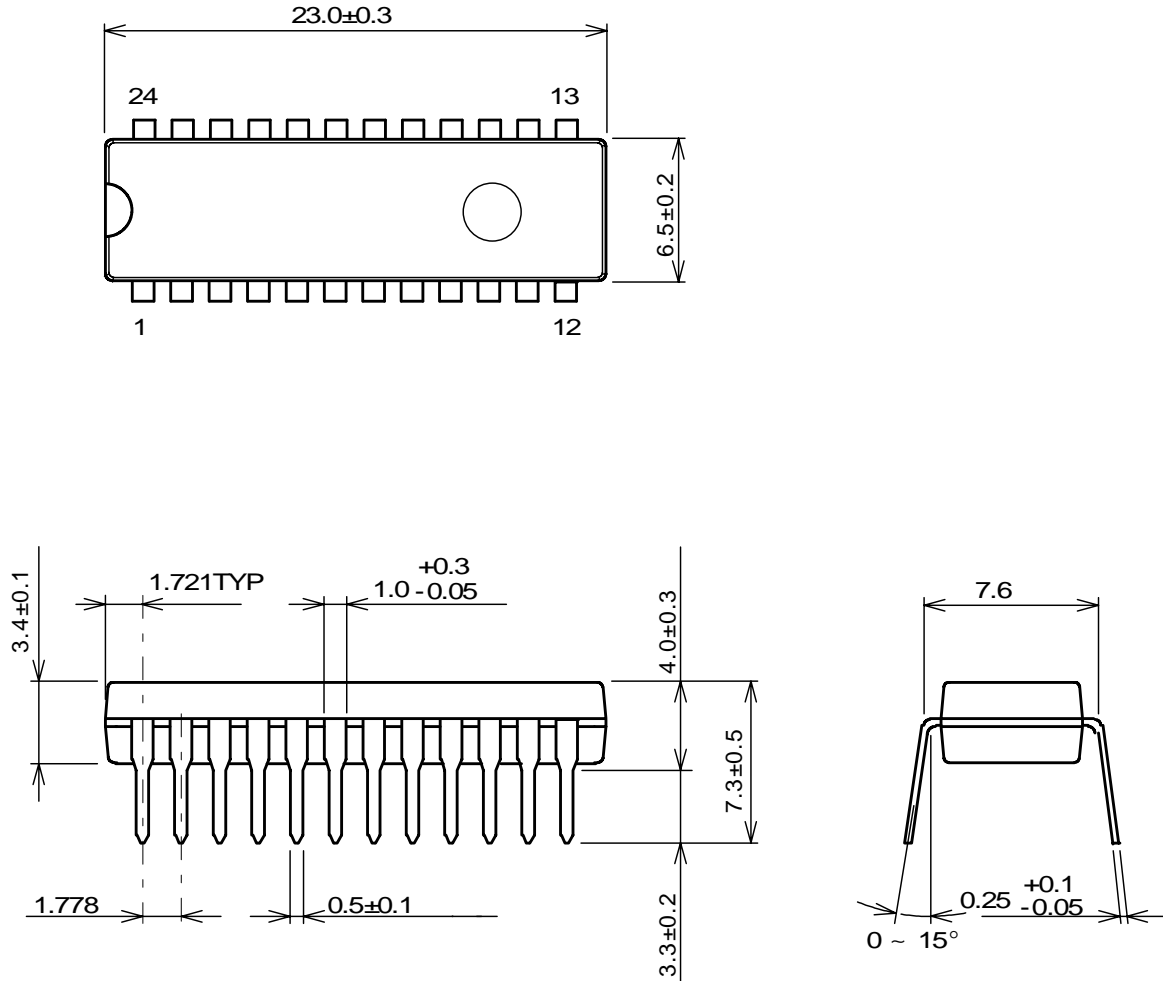

UNIT : mm