

SIGNAL PROCESSOR FOR COLOR TFT FOR NTSC

■GENERAL DESCRIPTION

The NJW1301 is a color TFT signal processor for NTSC. It contains Y/C separator circuit, color signal modulator, count down circuit, RGB demodulator, RGB interface, side black control circuit, PWM control circuit and common pole driver, required by color TFT signal processing.

It is suitable for car navigation system with color TFT panel.

■PACKAGE OUTLINE

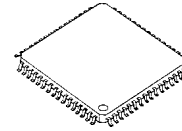

NJW1301FK1

■FEATURES

- Internal Y/C separator circuit
- NTSC matching for Composite
- Internal one systems input for analog RGB for NTSC/PAL
- Internal count down circuit at H,V
- Internal enhancer circuit
- Internal Side black control circuit
- Internal PWM control circuit
- Internal γ^2 point correction circuit
- Internal Color TFT Common pole driver
- Bi-CMOS technology
- Package Outline LQFP64

■BLOCK DIAGRAM

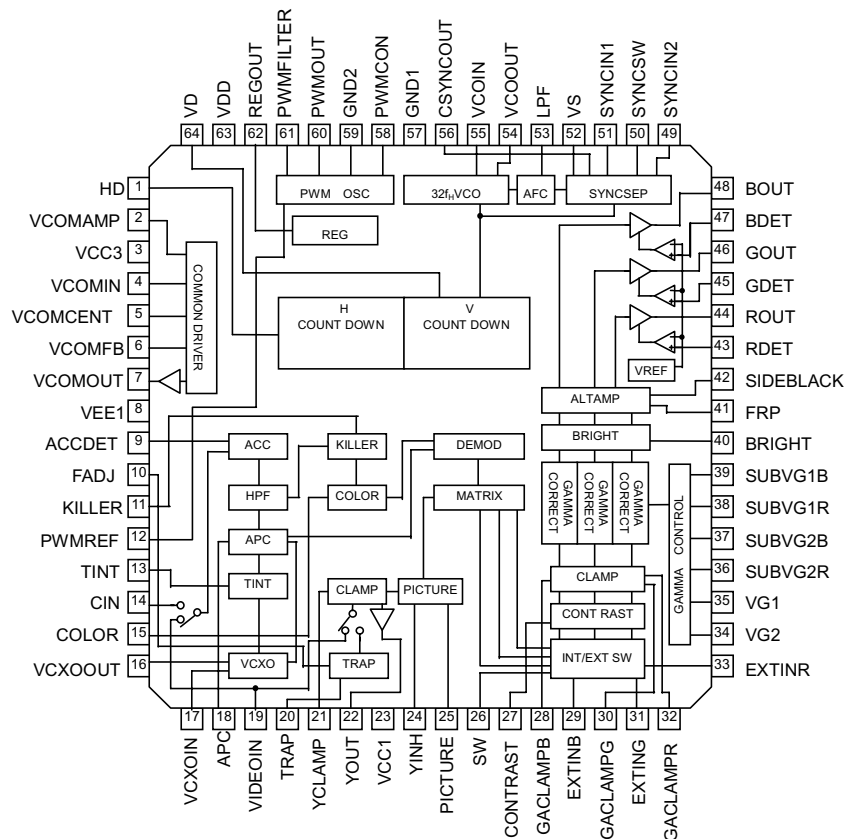

■ABSOLUTE MAXIMUM RATINGS

(Ta=25°C)

PARAMETERS	SYMBOL	RATINGS	UNIT
Supply Voltage 1	V _{CC1} -GND1	8.0	V
Supply Voltage 2	V _{CC3} -V _{EE1}	15.0	V
Supply Voltage 3	V _{DD} -GND1	7.0	V
Supply Voltage 4	V _{EE1} -GND1	-7.0	V
Power Dissipation	P _D	700	mW
Each Adjustment Terminal	V _{IN}	V _{CC1}	V
SYNC OUT Voltage	V _{SD}	V _{EE1} +15.0	V
Picture Input Voltage	V _{VDIN}	3.0	V _{P-P}
External Input Voltage	EXT _{IN}	V _{CC1}	V
FRP Input Signal Voltage	FRP _{IN}	V _{CC1}	V
SYNC Input Voltage	SYNC _{IN}	V _{CC1}	V
Analog RGB Input Signal	RGB _{IN}	3.0	V _{PP}
Operating Temperature Range	Topr	-30 to +85	°C
Storage Temperature Range	Tstg	-40 to +125	°C

■RECOMMENDED OPERATING CONDITION (Ta=25°C)

PARAMETER	SYMBOL	TEST CONDITION	MIN.	TYP.	MAX.	UNIT
Supply Voltage Range	-	V _{CC1} -GND	4.75	5.00	5.25	V
	-	V _{CC3} -V _{EE1}	11.00	12.00	13.00	V
	-	V _{EE1} -GND1	-5.25	-5.0	-4.75	V
	-	V _{DD} -GND1	4.75	5.00	5.25	V
Y Input Signal Voltage	Y _{IN}	Pedestal-White	0.30	0.35	0.40	V _{P-P}
C Input Signal Voltage	C _{IN}	Amplitude of Burst Signal	0.10	0.15	0.20	V _{P-P}
Analog RGB Input Signal	RGB _{IN}		0.6	0.7	0.8	V _{P-P}
SYNC Input Signal	SYNC _{IN}		0.3	1.0	1.5	V _{P-P}
Gamma 1 Adjust Voltage	VG1		1.5	-	3.5	V
Gamma 2 Adjust Voltage	VG2		1.5	-	3.8	V
Bright Adjust Voltage	BRIGHT		1.8	-	3.4	V
PWM Control Voltage	PWMCONT		0	-	5	V

(Point 1) When suspected SYNC input to NJW1301, necessary on 5H(1H:horizontal term ,about 63.5us) of pulth width of suspected SYNC.

(Point 2) Investigation Crosstalk level when design for depend to application.

(Point 3) Do not input the intermediate step signal at External terminal to use OSD signal for EXTRGB.
The EXRRGB accept only white(0.7V,white 100%) – black(0V)signal.

■ELECTRICAL CHARACTERICS

(Ta=25°C, V_{CC1}=5V, V_{CC3}=7V, V_{DD}=5V, V_{EE1}=-5V, TP2=TP5=TP27=TP40=2.5V, TP13=2.9V, TP15=3.1V, TP34=3.0V, TP35=1V, TP26=TP42=5V, TP50=5V, TP58=4.7V, SW14=SW25=SW26=SW50=L)

PARAMETERS	SYMBOL	TEST CONDITIONS	MIN.	TYP.	MAX	UNIT
Operating Current 1	I _{CC1}	V _{CC1}	-	45.0	60.0	mA
Operating Current 2	I _{CC3}	V _{CC3}	-	5.8	7.7	mA
Operating Current 3	I _{DD4}	V _{DD}	-	6.0	7.5	mA
Operating Current 4	I _{EE1}	V _{EE1}	-11.8	-7.5	-	mA
Contrast Adjust Gain Variable Range	G _{CT1}	SG1 applied to TP29 ,TP31 and TP33,SG10 applied to TP41,SG2 applied to TP51, define the each amplitude (BLK-WHT) at SW26=H, and TP27=0V,2.5V,5V as V1,V2 and V3, measure the each output of the non-inverting G _{CT1} =20LOG(V1/V2) G _{CT2} =20LOG(V3/V2) Rout,Gout,Bout terminals.	-	-12.0	-9.0	dB
	G _{CT2}		1.0	2.5	-	
Image Quality Adjust Variable Minimum Range(Y/C)	G _{PSMIN1}	SG3(100KHz,1.8MHz) applied to TP19,SG10 applied to TP41,SG2 applied to TP51,measure amplitude on TP46 of non-inverting. Define the each gain on SG3 of sin signal of frequency as G(1.8M),G(100K) when SW14=L,SW25=H,TP25=0V G _{PSMIN1} =G(1.8M)-G(100K) when SW14=L,SW25=H,TP25=5V G _{PSMAX1} =G(1.8M)-G(100K)	-	-2.0	2.0	dB
Image Quality Adjust Variable Maximum Range(Y/C)	G _{PSMAX1}		5.0	7.5	-	
Image Quality Adjust Variable Minimum Range(Composite)	G _{PSMIN2}	SW14=H,TP14(B)=0V, SG3(100KHz,1.8MHz) applied to TP19,SG10 applied to TP41,SG2 applied to TP51,measure amplitude of non-inverting of TP46. Define the each gain on SG3 of sin signal of frequency as G(1.8M),G(100K) when SW14=H,SW25=H,TP25=0V G _{PSMIN2} =G(1.8M)-G(100K) when SW14=H,SW25=H,TP25=5V G _{PSMAX2} =G(1.8M)-G(100K)	-	4.0	0.0	dB
Image Quality Adjust Variable Maximum Range(Composite)	G _{PSMAX2}		3.0	5.5	-	
Trap attenuation	G _{CF}	SW14=H,TP14(B)=0V, SG3(100KHz,3.579545MHz) applied to TP19,SG2 applied to TP51,when define the each amplitude of TP22 at SG3 (3.579545MHz),SG3(100KHz) as B1,B2. G _{CF} =20*LOG(B1/B2)	-	-35	-20	dB

■ELECTRICAL CHARACTERICS

(Ta=25°C, V_{CC1}=5V, V_{CC3}=7V, V_{DD}=5V, V_{EE1}=-5V, TP2=TP5=TP27=TP40=2.5V, TP13=2.9V, TP15=3.1V, TP34=3.0V, TP35=1V, TP26=TP42=5V, TP50=5V, TP58=4.7V, SW14=SW25=SW26=SW50=L)

PARAMETERS	SYMBOL	TEST CONDITIONS	MIN.	TYP.	MAX	UNIT
ACC Characteristic (NTSC)	G _{A1}	SG10 applied to TP41, SG6(3.579545MHz, typical swing150mVpp) applied to TP14, SG2 applied to TP51. Define the each amplitude on TP46 at 0dB, +6dB, -25dB toward SG6 as Vo1, Vo2 and Vo3. G _{A1} =20LOG(Vo2/Vo1) G _{A2} =20LOG(Vo3/Vo1)	-	0.0	2.0	dB
	G _{A2}		-12.5	-7.5	-	
Color Control Gain Variable Range	G _{c1}	SG10 applied to TP41, SG6(3.579545MHz, typical swing150mVpp) applied to TP14, SG2 applied to TP51. Define the each amplitude on TP46 at TP15=0V, 3.1V, 5.0V as Vo1, Vo2 and Vo3. G _{C1} =20LOG(Vo1/Vo2) G _{C2} =20LOG(Vo3/Vo2)	-70	-50	-40	dB
	G _{c2}		0.7	2.0	-	
APC Capture Range	f _{A1}	SG10 applied to TP41, SG6(3.579545MHz, 150mVpp) applied to TP14, variable the BURST frequency until the voltage on TP11 drops below 2V. Work out the difference between the frequency at that time and 3.579545MHz. f _{A1} =when approach BURST frequency from low frequency. f _{A2} = when approach BURST frequency from high frequency	-	-2900	-700	Hz
	f _{A2}		+700	+1500	-	
Composite→Y/C input switching voltage	V _{THCY}	SG3(350mVpp, 3.579545MHz) applied to TP19, SG2 applied to TP51, SG10 applied to TP41, SW14=H. Increase TP14(B), change from composite to Y/C. Then measure the voltage on TP14(B).	1.3	1.6	1.9	V
Y/C→Composite input switching voltage	V _{THYC}	SG3(350mVpp, 3.579545MHz) applied to TP19, SG2 applied to TP51, SG10 applied to TP41, SW14=H. Decrease TP14(B), change from Y/C to composite. Then measure the voltage on TP14(B).	0.7	1.0	1.3	V

■ELECTRICAL CHARACTERISTICS

(Ta=25°C, V_{CC1}=5V, V_{CC3}=7V, V_{DD}=5V, V_{EE1}=-5V, TP2=TP5=TP27=TP40=2.5V, TP13=2.9V, TP15=3.1V, TP34=3.0V, TP35=1V, TP26=TP42=5V, TP50=5V, TP58=4.7V, SW14=SW25=SW26=SW50=L)

PARAMETERS	SYMBOL	TEST CONDITIONS	MIN.	TYP.	MAX	UNIT
TINT Variable Range	Θ_{T1}	SG6(3.579545MHz, 150mVpp) applied to TP14, SG2 applied to TP51, SG10 applied to TP41. Define the phase causing the maximum amplitude at TP13=1.6V on TP46 as Θ_1 . Define the each phase causing the maximum amplitude at TP13=2.8V, 4.0V on TP46 as Θ_2 and Θ_3 .	30	45	-	deg
	Θ_{T2}	$\Theta_{T1}=\Theta_1-\Theta_2$ $\Theta_{T2}=\Theta_3-\Theta_2$	-	-45	-30	
NTSC /PAL Switching Voltage	V _{THNP}	Decrease the voltage on TP13 until the signal on TP64 frequency at 50Hz. Measure voltage on TP13.	0.4	0.7	1.0	V
Color Killer Operating Input Level	V _{KIN}	TP41=5V, SG6(3.58MHz, 150mVp p) applied to TP14, SG2 applied to TP51, decrease the input amplitude until the killer is turned on, and measure the input attenuation.	-	-42	-37	dB
Output Level Voltage Difference among RGB	ΔV_{BRGB}	SW26=H, TP26=H. SG10 applied to TP41, SG1(0.7Vpp) applied to TP29, 31, 33, SG2 applied to SG2. Then define the non-inverting side of TP44, TP46, TP48 as VRB, VGB, and VBB, the invert side of them as VRBI, VGBI, and VBBI. $\Delta V_{BRGB} = VRB - VGB, VBB - VGB = VRBI - VGBI, VBBI - VGBI$	-150	0	150	mV
INT-EXT Output Black Level Voltage Difference	ΔV_{BIE}	SG4 applied to SW26=L, TP19, define the non-inverting side of TP44, TP46, TP48 as VRB(Y), VGB(Y), and VBB(Y), the invert side of VRBI(Y), VGBI(Y), and VBBI(Y). $VBIE = VRB - VRBI(Y), VGB - VGBI, = VBB - VBB(Y), VRBI - VRBI(Y), = VGBI - VGBI(Y), VBBI - VBBI(Y)$	-150	0	150	mV

■ELECTRICAL CHARACTERICS

(Ta=25°C, V_{CC1}=5V, V_{CC3}=7V, V_{DD}=5V, V_{EE1}=-5V, TP2=TP5=TP27=TP40=2.5V, TP13=2.9V, TP15=3.1V, TP34=3.0V, TP35=1V, TP26=TP42=5V, TP50=5V, TP58=4.7V, SW14=SW25=SW26=SW50=L)

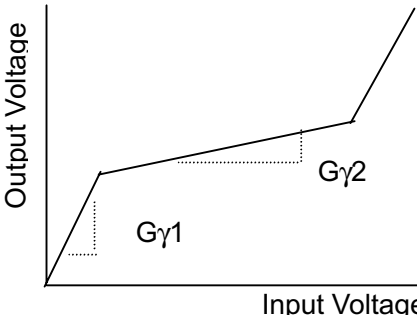
PARAMETERS	SYMBOL	TEST CONDITIONS	MIN.	TYP.	MAX	UNIT
Gain Difference Between Invert And Non-invert	ΔG_{INV}	SW26=H, TP26=H. SG10 applied to TP29,31,33,41, SG1(0.7Vpp) applied to TP41, SG2 applied to TP51, measure the amplitude(BLK-WHT) of TP44, TP46, TP48. Define the non-inverting side of VRG, VGG, VBG, the invert side of VRGI, VGGI, VBGI.	-0.6	0	0.6	dB
Gain Difference Among RGB	ΔV_{RGB}	$\Delta G_{INV}=20\text{LOG}(VRGI/VRG)$ $=20\text{LOG}(VGGI/VGG)$ $=20\text{LOG}(VBGI/VBG)$ $\Delta V_{RGB}=20\text{LOG}(VRG/VGG)$ $=20\text{LOG}(VGG/VBG)$ $=20\text{LOG}(VBG/VRG)$	-0.6	0	0.6	
FRP Input Threshold Voltage	V_{THFRP}	TP51=SG2, SW26=H, TP26=H, SG1 applied to TP31, increase TP41 until the signal on TP46 invert.	1.2	1.5	1.8	V
Interface Frequency Characteristic	f_{INT}	SW26=H, TP26=H, SG10 applied to TP41, SG5(100kHz) applied to TP31, SG2 applied to TP51. for making the amplitude of sine wave part of the non-invert signal on TP46, increase the frequency until attenuate by 3dB from the amplitude at the 100kHz.	4.5	5.5	-	MHz
EXTRGB Input Threshold Voltage	V_{THEXH}	Switching Voltage of TP26 V _{THEXH} =ON Level Voltage V _{THEXL} =OFF Level Voltage	3.3	-	-	V
	V_{THEXL}		-	-	1.6	
Gamma Characteristic	$G_{\gamma 1}$	SW26=H, TP26=H, SG2 applied to TP51, SG10 applied to TP41, SG7(0.35Vpp) applied to TP29,31,33. Define at TP35=1.8V, TP34=3.0V, measure the slope on TP44, TP46, and TP48.	16.0	20.0	24.0	dB
	$G_{\gamma 2}$			5.0	9.0	

■ELECTRICAL CHARACTERISTICS

(Ta=25°C, V_{CC1}=5V, V_{CC3}=7V, V_{DD}=5V, V_{EE1}=-5V, TP2=TP5=TP27=TP40=2.5V, TP13=2.9V, TP15=3.1V, TP34=3.0V, TP35=1V, TP26=TP42=5V, TP50=5V, TP58=4.7V, SW14=SW25=SW26=SW50=L)

PARAMETERS	SYMBOL	TEST CONDITIONS	MIN.	TYP.	MAX	UNIT
AFC Lock Range	Δf_{HL1}	SW26=H, TP26=H, SG2 applied to TP51. Define frequency of miss lock SYNC at valuable frequency of SG2 when AFC is lock.	-	700	-	Hz
	Δf_{HL2}	Δf_{HL1} =miss lock to high frequency Δf_{HL2} =miss lock to low frequency	-	-1000	-	
AFC Capture Range	Δf_{HP1}	SW26=H, TP26=H, SG2 applied to TP51. define frequency of miss lock SYNC at valuable frequency of SG2 when AFC is miss lock.	-	700	-	Hz
	Δf_{HP2}	Δf_{HP1} =capture from high frequency Δf_{HP2} =capture from low frequency	-	-1000	-	
AFC Free-run Frequency	f_{OH}	TP51 is non-input. Measure the output frequency on TP1.	15.5	15.7	15.9	kHz
Horizontal Output Pulth Width	P _{WHD}	TP51 is non-input. Measure the output pulth width on TP1.	3.5	3.9	4.3	us
Horizontal Output Delay	T _{PDH}	SW26=H, TP26=H, SG2 applied to TP51. Measure the delay time between before external filter and TP1 output.	0.95	1.10	1.25	us
Horizontal Output Saturation Level	V _{OLH}	SG2 applied to TP51. Measure the output of low level on TP1.	-	0.1	0.3	V
Vertical Output Pulth Width	P _{WVD}	SG2 applied to TP51. Measure the output pulth width on TP64.	3.5	4.0	4.5	H
Vartical Output Delay	T _{PVD}	SW26=H, TP26=H, SG2 applied to TP51. Measure the delay time between before external filter and TP64 output.	0.45	0.65	0.85	H
SYNC SW Input Threshold Voltage	V _{THSH}	Switching Voltage of TP50 V _{THSH} =ON level voltage V _{THSL} =OFF level voltage	3.3	-	-	V
	V _{THSL}		-	-	1.6	
C.SYNC Low Output Voltage	V _{LCS}	SW26=H, TP26=H, SG2 applied to TP51. Measure the low level of output on TP56.	-	0.2	0.5	V
C.SYNC Output Delay	T _{PCS}	SW26=H, TP26=H, SG2 applied to TP51. Measure the delay time between before external filter and TP56 output.	0.90	1.05	1.22	us

■ELECTRICAL CHARACTERICS

(Ta=25°C, V_{CC1}=5V, V_{CC3}=7V, V_{DD}=5V, V_{EE1}=-5V, TP2=TP5=TP27=TP40=2.5V, TP13=2.9V, TP15=3.1V, TP34=3.0V, TP35=1V, TP26=TP42=5V, TP50=5V, TP58=4.7V, SW14=SW25=SW26=SW50=L)

PARAMETERS	SYMBOL	TEST CONDITIONS	MIN.	TYP.	MAX	UNIT
Crosstalk Among RGB	CTRGB1	TP51=SG2, SW26=H, TP26=H, TP41=H, SG5(1MHz, 700mVpp) applied to TP29. TP31, TP33=GND. Measure the amplitude of 1MHz component on TP44, TP46 and TP48. Calculate the amplitude ratio of TP46 and TP48 to TP44.	-	-50	-40	dB
	CTRGB2	TP51=SG2, SW26=H, TP26=H, TP41=H, SG5(1MHz, 700mVpp) applied to TP31. TP29, TP33=GND. Measure the amplitude of 1MHz component on TP44, TP46 and TP48. Calculate the amplitude ratio of TP44 and TP48 to TP46.	-	-50	-40	
	CTRGB3	TP51=SG2, SW26=H, TP26=H, TP41=H, SG5(1MHz, 700mVpp) applied to TP33. TP29, TP31=GND. Measure the amplitude of 1MHz component on TP44, TP46 and TP48. Calculate the amplitude ratio of TP44 and TP46 to TP48.	-	-50	-40	
Crosstalk 1 Between SW (EXT→INT)	CTERINT	TP51=SG2, SW26=H, TP41=H, TP19=GND. SG5(1MHz, 700mVpp) applied to TP33. Measure the amplitude of 1MHz component on TP44. Calculate the amplitude ratio of TP26=5V, 0V.	-	-50	-35	dB
	CTEGINT	TP51=SG2, SW26=H, TP41=H, TP19=GND. SG5(1MHz, 700mVpp) applied to TP31. Measure the amplitude of 1MHz component on TP46. Calculate the amplitude ratio of TP26=5V, 0V.	-	-50	-35	
	CTEBINT	TP51=SG2, SW26=H, TP41=H, TP19=GND. SG5(1MHz, 700mVpp) applied to TP29. Measure the amplitude of 1MHz component on TP48. Calculate the amplitude ratio of TP26=5V, 0V.	-	-50	-35	

■ELECTRICAL CHARACTERICS

(Ta=25°C, V_{CC1}=5V, V_{CC3}=7V, V_{DD}=5V, V_{EE1}=-5V, TP2=TP5=TP27=TP40=2.5V, TP13=2.9V, TP15=3.1V, TP34=3.0V, TP35=1V, TP26=TP42=5V, TP50=5V, TP58=4.7V, SW14=SW25=SW26=SW50=L)

PARAMETERS	SYMBOL	TEST CONDITIONS	MIN.	TYP.	MAX	UNIT
Crosstalk 2 Between SW (EXT→INT)	CTE1E2R	TP51=SG2, SW26=H, TP41=H, TP33=GND. SG3(1MHz, 350mVpp) applied to TP19. Measure the amplitude of 1MHz component on TP44. Calculate the amplitude ratio of TP26=5V, 0V.	-	-50	-35	dB
	CTE1E2G	TP51=SG2, SW26=H, TP41=H, TP31=GND. SG3(1MHz, 350mVpp) applied to TP19. Measure the amplitude of 1MHz component on TP46. Calculate the amplitude ratio of TP26=5V, 0V.	-	-50	-35	
	CTE1E2B	TP51=SG2, SW26=H, TP41=H, TP29=GND. SG3(1MHz, 350mVpp) applied to TP19. Measure the amplitude of 1MHz component on TP48. Calculate the amplitude ratio of TP26=5V, 0V.	-	-50	-35	
PWM Frequency	f _{PWM}	TP58=2.5V. Measure the frequency on TP60.	-	90	-	Hz
PWM Characteristics	D _{PWM}	Measure the duty on TP60 when TP58=2.5V.	-	50	-	%
PWM OFF Voltage	V _{PWM1}	Define the voltage on TP58 at TP60 is Low.	-	4.5	4.7	V
PWM ON Voltage	V _{PWM2}	Define the voltage on TP58 at TP60 is High.	0.3	0.5	-	V

■ELECTRICAL CHARACTERICS

(Ta=25°C, V_{CC1}=5V, V_{CC3}=7V, V_{DD}=5V, V_{EE1}=-5V, TP2=TP5=TP27=TP40=2.5V, TP13=2.9V, TP15=3.1V, TP34=3.0V, TP35=1V, TP26=TP42=5V, TP50=5V, TP58=4.7V, SW14=SW25=SW26=SW50=L)

PARAMETERS	SYMBOL	TEST CONDITIONS	MIN.	TYP.	MAX	UNIT
Side-black Level	V _{SB}	TP41=SG10, TP51=SG2. When TP42=5V, define the non-inverting black level of TP44, TP46, TP48 as VRB, VGB, VBB. When TP42=5V, define the inverting black level of TP44, TP46, TP48 as VRBI, VGBI, VBBI. When TP42=0V, define the non-inverting black level of TP44, TP46, TP48 as VRB(B), VGB(B), VBB(B). When TP42=0V, define the inverting black level of TP44, TP46, TP48 as VRBI(B), VGBI(B), VBBI(B). VdBLACK=VRB-VRB(B), VGB-VGB(B), VBB-VBB(B) =VRBI(B)-VRBI, VGBI(B)-VGBI, VBBI(B)-VBBI	-	500	-	mV
VCOM Output Slew Rate	SRVCOM	SG9 applied to TP4. Measure the turn on and turn off time at 20% to 80% on TP6 output wave. Then convert to slew rate.	4.0	9.0	-	V/us
VCOM Center Voltage	VCVCOM	SG9 applied to TP4. Measure the center voltage of TP6 output voltage.	0.9	1.2	1.5	V
VCOM Amplitude	VAVCOM	SG9 applied to TP4. Measure the output amplitude on TP6.	6.0	6.5	7.0	V _{P-P}
Delay Between Y-C	ΔTdYC		-	0	-	ns
RGB Slew Rate	SR _{RGB}	TP29, TP31, TP33=SG8, TP41=SG10, TP51=SG2. Measure the turn on and turn off time at 20% to 80% of output wave on TP44, TP46, TP48. Then convert to slew rate.	9	22	40	V/us

■ELECTRICAL CHARACTERICS

(Ta=25°C, V_{CC1}=5V, V_{CC3}=7V, V_{DD}=5V, V_{EE1}=-5V, TP2=TP5=TP27=TP40=2.5V, TP13=2.9V, TP15=3.1V, TP34=3.0V, TP35=1V, TP26=TP42=5V, TP50=5V, TP58=4.7V, SW14=SW25=SW26=SW50=L)

PARAMETERS	SYMBOL	TEST CONDITIONS	MIN.	TYP.	MAX	UNIT
Demodulation Relativity Ampulitude (R-Y/B-Y)	$\frac{R-Y}{B-Y}$	SG10 applied to TP41, SG6(3.58MHz, 150mVpp) applied to TP41, SG2 applied to TP51, TP14 applied to TP51. TP34=3.0V, TP35=1.5V, vary the chroma phase on SG6,	-	0.65	-	-
Demodulation Relativity Ampulitude (G-Y/B-Y)	$\frac{G-Y}{B-Y}$	define non-inverting maximum output amplitude of TP44, TP46, TP48 as VR, VG, VB. $(R-Y)/(B-Y)=VR/VB$ $(G-Y)/(B-Y)=VG/VB$	-	0.45	-	
Demodulation Relativity Phase (R-Y/B-Y)	Θ_{RB}	SG10 applied to TP41, SG6(3.58MHz, 150mVpp) applied to TP14, SG2 applied to TP51, TP34=3.0V, TP35=1.5V, vary the chroma phase on SG6, define tne phase at maximum output amplitude of TP44, TP46, TP48 as $\Theta_R, \Theta_G, \Theta_B$.	-	105	-	deg
Demodulation Relativity Phase (G-Y/B-Y)	Θ_{GB}	$\Theta_{RB}=\Theta_R-\Theta_B$ $\Theta_{GB}=\Theta_G-\Theta_B$	-	240	-	
Demodulation Output residual Carrier	VCR	TP41=5V, SG6(3.58MHz, 150mVpp) applied to TP14, SG2 applied to TP51, adjust the chroma phase on SG6 for maximum the amplitude of TP48. Measure the ratio of 7.159059MHz component to the 15.734kHz component.	-	40	-	dB
Horizontal AFC Keep Limit Input	V _{INPM}	SW26=H, TP26=H, TP51=SG2. define the amplitude of miss lock SYNC at decrease amplituide of SG2 when AFC is miss lock.	-	15	28	mV

■ Application Circuit

(Vcc1=5V, Vcc3=7V, VDD=5V, VEE1=-5V, GND1=0V, GND2=0V)

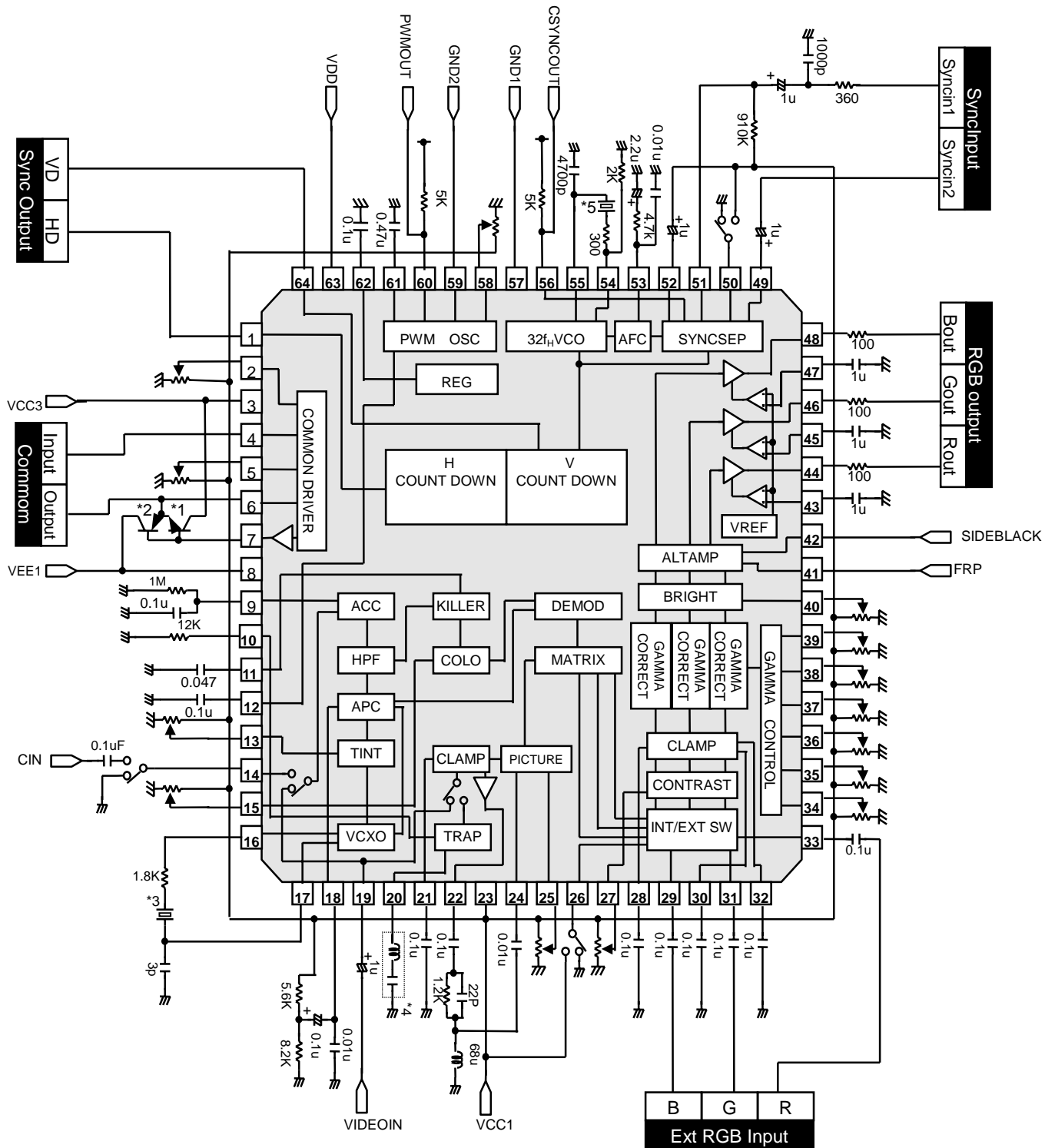

- 1 : 2SC2120Y, 2SC1959Y
- 2 : 2SA950Y, 2SA562TM
- 3 : 3.579545MHz X'tal DSX151GA(Daishinku)
- 4 : NTL4532-S3R6B(TDK)
- 5 : 32fH Ceramic CSBLA503KECF2(Murata)

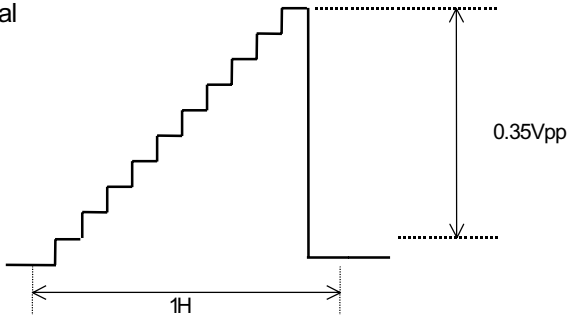
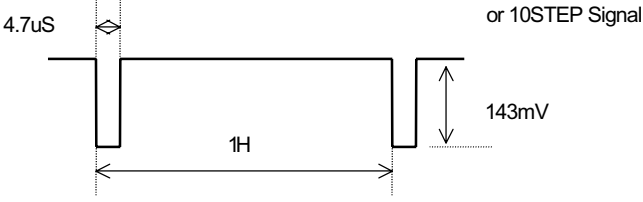
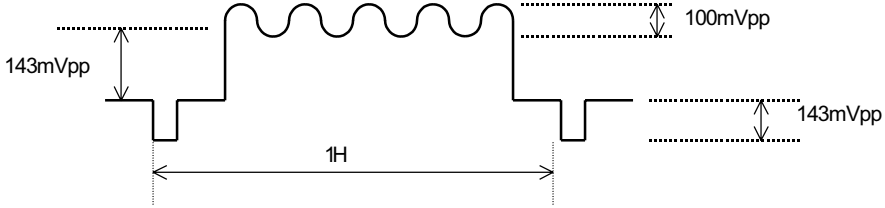
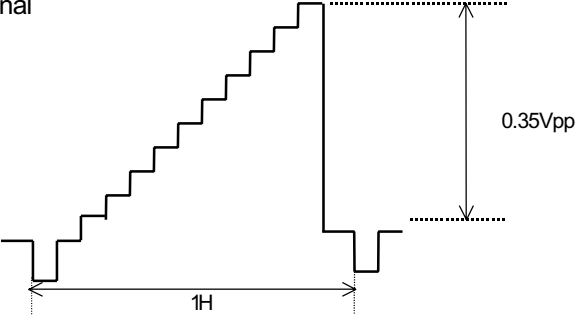
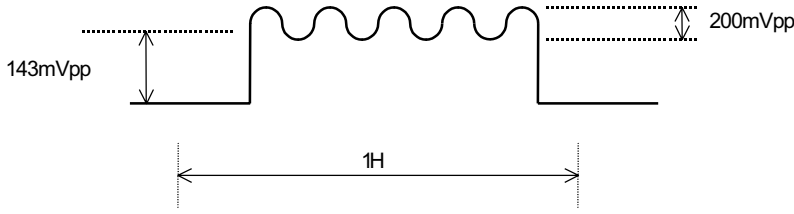
<p>SG1</p>	<p>No Sync 10STEP Signal</p> 
<p>SG2</p>	<p>Composite Y signal with Sync</p> 
<p>SG3</p>	<p>Sine Video Signal with Sync</p> 
<p>SG4</p>	<p>10 STEP Video Signal</p> 
<p>SG5</p>	<p>No Signal Sine Video Signal</p> 

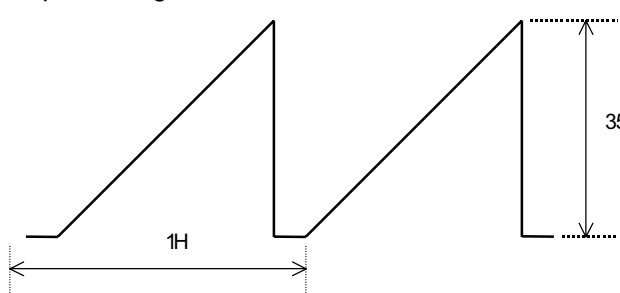
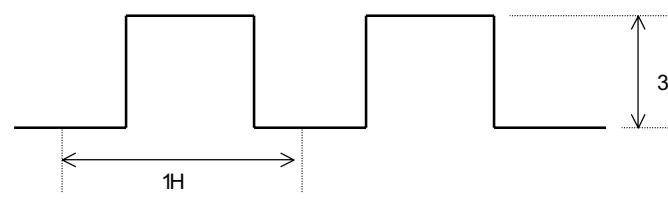
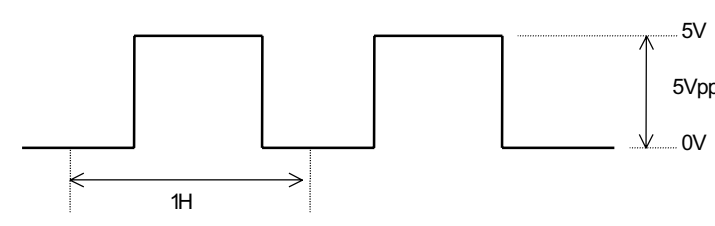
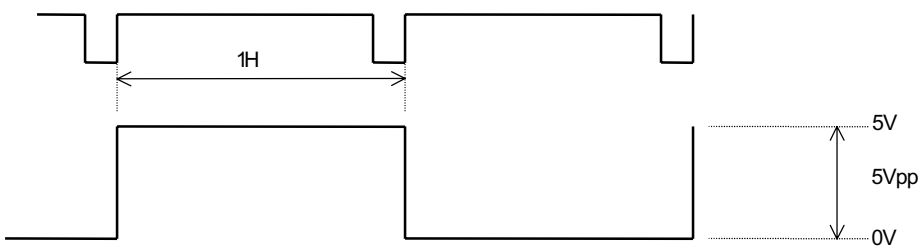
SG6	<p>C Signal</p>  <p style="text-align: right;">Burst Amplitude=150mVpp Chroma Amplitude=150mVpp</p>
SG7	<p>No Sync Ramp Video Signal</p>  <p style="text-align: right;">350mVpp</p>
SG8	<p>Video Signal of Turn ON, Turn OFF Under 50nS</p>  <p style="text-align: right;">350mVpp</p>
SG9	<p>Turn ON, Turn OFF Under 50nS</p>  <p style="text-align: right;">5V 5Vpp 0V</p>
SG10	<p>FRP Signal of Inverting Every 1H</p>  <p style="text-align: right;">5V 5Vpp 0V</p>

NJW1301

■ EQUIVALENT CIRCUIT

PIN NO.	SYMBOL	FUNCTION	INSIDE EQUIVALENT CIRCUIT
1	HD	Horizontal synchronous-signal output The output signal synchronizes with video signal and C-MOS output	
2	VCOM AMP	Adjust the VCOM signal level Adjustable range: $V_{COM}=6.5\pm 2.0V$	
3	VCC3	Supply to VCOM voltage Connect to +7V supply	
4	VCOMIN	VCOM 5V _{P-P} signal input	

■ EQUIVALENT CIRCUIT

PIN NO.	SYMBOL	FUNCTION	INSIDE EQUIVALENT CIRCUIT
5	VCOM CENT	Adjust the center of VCOM voltage Adjustable range: $V_{COMCENT}=1.2\pm 1.5V$	
6	VCOMFB	VCOM feedback signal Input the feedback signal (VCOMOUT) through the discrete transistor buffer	
7	VCOM OUT	VCOM signal output Drive the common by connect discrete transistor	
8	VEE1	Connect -5V supply at lowest voltage	

NJW1301

■ EQUIVALENT CIRCUIT

PIN NO.	SYMBOL	FUNCTION	INSIDE EQUIVALENT CIRCUIT
9	ACCDET	Connect to the ACC filter	
10	FADJ	Adjust the frequency with internal filter	
11	KILLER	Connect to the color killer filter	
12	PWMREF	Reference voltage for PWM comparator, with decoupling capacitor Internal use only, (Do not use for regulator purpose)	

■ EQUIVALENT CIRCUIT

PIN NO.	SYMBOL	FUNCTION	INSIDE EQUIVALENT CIRCUIT
13	TINT	Adjust Hue signal Adjustable Hue range: $\pm 45^\circ$ to control DC supply TINT=GND: PAL mode with RGB input only =High: NTSC mode	
14	CIN	Chroma signal input, $150\text{mV}_{\text{P.P}}$ CIN=GND: Composite input mode	
15	COLOR	Adjust color Adjust the tint color by input voltage	
16	VCXO OUT	VCXO output	

NJW1301

■ EQUIVALENT CIRCUIT

PIN NO.	SYMBOL	FUNCTION	INSIDE EQUIVALENT CIRCUIT
17	VCXOIN	VCXO input	
18	APC	Connect to the APC detector filter	
19	VIDEOIN	Composite Video Signal/Y-signal input CIN=GND: Composite input mode	
20	TRAP	Connect to the TRAP filter for Y/C separate	

■ EQUIVALENT CIRCUIT

PIN NO.	SYMBOL	FUNCTION	INSIDE EQUIVALENT CIRCUIT
21	YCLAMP	Connect to the CLAMP capacitor for Y-signal	
22	YOUT	Y-signal output Connect to the second differential filter	
23	VCC1	Supply voltage, +5V	
24	YINH	Y-signal input of high frequency division	

NJW1301

■ EQUIVALENT CIRCUIT

PIN NO.	SYMBOL	FUNCTION	INSIDE EQUIVALENT CIRCUIT
25	PICTURE	Adjust the frequency of Y-signal for revise outline of Y-signal Emphasize outline, when voltage increase	
26	SW	Select the internal/external signal SW=Low: Internal signal mode =High: External signal mode	
27	CONT RAST	Adjust the gain of RGB signal Adjust the RGB signal range by CONTRAST input voltage	
28	GA CLAMPB	Connect to the CLAMP capacitor for CLAMP pedestal level of B signal Leakless capacitor for use	

■ EQUIVALENT CIRCUIT

PIN NO.	SYMBOL	FUNCTION	INSIDE EQUIVALENT CIRCUIT
29	EXTINB	External B(RGB) signal input, 700mV _{P-P} and source color signal	
30	GA CLAMPG	Connect to the CLAMP capacitor for CLANP pedestal level of G signal Leakless capacitor for use	
31	EXTING	External G(RGB) signal input, 700mV _{P-P} and source color signal	
32	GA CLAMPR	Connect to the CLAMP capacitor for CLANP pedestal level of R signal Leakless capacitor for use	

NJW1301

■ EQUIVALENT CIRCUIT

PIN NO.	SYMBOL	FUNCTION	INSIDE EQUIVALENT CIRCUIT
33	EXTINR	External R(GB) signal input, 700mV _{P-P} and source color signal	
34	VG2	Adjust the second point of high side in RGB γ characteristic Pre-set and controlled RGB together	
35	VG1	Adjust the first point of low side in RGB γ characteristics Pre-set and controlled RGB together	
36	SUB VG2R	Adjust the second point of high side in R signal γ characteristic Pre-set and not controlled RGB together, Adjust the R signal only	

■ EQUIVALENT CIRCUIT

PIN NO.	SYMBOL	FUNCTION	INSIDE EQUIVALENT CIRCUIT
37	SUB VG2B	Adjust the second point of high side in B signal γ characteristic Pre-set and not controlled RGB together, Adjust the B signal only	
38	SUB VG1R	Adjust the first point of low side in R signal γ characteristic Pre-set and not controlled RGB together, Adjust the R signal only	
39	SUB VG1B	Adjust the first point of low side in B signal γ characteristic Pre-set and not controlled RGB together, Adjust the B signal only	
40	BRIGHT	Adjust the bright of RGB signal, controlled black level	

NJW1301

■ EQUIVALENT CIRCUIT

PIN NO.	SYMBOL	FUNCTION	INSIDE EQUIVALENT CIRCUIT
41	FRP	Inverte pulth input for RGB output signal, 5V _{P-P}	
42	SIDE BLACK	Control signal input with both black side of monitor, when aspect ratio change 4:3 and 16:9 SIDEBLACK=Low: Black level, control RGB together	
43	RDET	Connect to the capacitor for R-signal center modulator Leakless capacitor for use	
44	ROUT	R-signal output	

■ EQUIVALENT CIRCUIT

PIN NO.	SYMBOL	FUNCTION	INSIDE EQUIVALENT CIRCUIT
45	GDET	Connect to the capacitor for G-signal center modulator Leakless capacitor for use	
46	GOUT	G-signal output	
47	BDET	Connect to the capacitor for B-signal center modulator Leakless capacitor for use	
48	BOUT	B-signal output	

NJW1301

■ EQUIVALENT CIRCUIT

PIN NO.	SYMBOL	FUNCTION	INSIDE EQUIVALENT CIRCUIT
49	SYNCIN2	Synchronous signal input, synchronize with RGBOUT Input level is $2V_{P-P}$ maximum, and can input include Y-signal and composite video signals	
50	SYNCSW	Select to the SYNCIN1/SYNCIN2 SYNCSW=Low: Output is SYNCIN1 =High: Output is SYNCIN2	
51	SYNCIN1	Synchronous signal input, synchronize with RGBOUT Input level is $2V_{P-P}$ maximum, and can input include Y-signal and composite video signals.	
52	VS	Connect to the capacitor with integrate vartical-synchronous-signal	

■ EQUIVALENT CIRCUIT

PIN NO.	SYMBOL	FUNCTION	INSIDE EQUIVALENT CIRCUIT
53	LPF	Connect to the AFC filter	
54	VCOOUT	$32f_H$ VCO output	
55	VCOIN	$32f_H$ VCO input	
56	CSYNC OUT	Composite synchronous signal output, non-inverting and open collector	

NJW1301

■ EQUIVALENT CIRCUIT

PIN NO.	SYMBOL	FUNCTION	INSIDE EQUIVALENT CIRCUIT
57	GND1	Connect to GND.	
58	PWM CONT	Adjust the duty of PWM signal for backlight, 0-100% duty	
59	GND2	GND for PWM oscillator circuit, Noise sensitive	
60	PWMOUT	PWM output for backlight, open collector output	

■ EQUIVALENT CIRCUIT

PIN NO.	SYMBOL	FUNCTION	INSIDE EQUIVALENT CIRCUIT
61	PWM FILTER	Connect to the oscillation filter with PWM circuit for backlight	
62	REGOUT	Regulator output, connect to decupling capacitor Internal use only	
63	VDD	Supply voltage for synchronous, +5V	
64	VD	Vertical synchronous signal output, C-MOS output	

NJW1301

■PIN FUNCTION at NO USE

No	SYMBOL	FUNCTION	No	SYMBOL	FUNCTION
1	HD	OPEN	33	EXTINR	OPEN
2	VCOMAMP	OPEN	34	VG2	Input fixed DC voltage
3	VCC3	OPEN: when do not use VCOM	35	VG1	Input fixed DC voltage
4	VCOMIN	OPEN	36	SUBVG2R	OPEN
5	VCOMCENT	OPEN	37	SUBVG2B	OPEN
6	VCOMFB	OPEN	38	SUBVG1R	OPEN
7	VCOMOUT	OPEN	39	SUBVG1B	OPEN
8	VEE1	GND: when do not use VCOM	40	BRIGHT	Input fixed DC voltage
9	ACCDDET	OPEN	41	FRP	Input inverting pulse of RGB output
10	FADJ	Connect with 12K Ω	42	SIDEBLACK	OPEN
11	KILLER	OPEN	43	RDET	Connect to capacitor for demodulate R signal
12	PWMREF	OPEN	44	ROUT	OPEN
13	TINT	NTSC MODE: 1V or higher voltage PAL MODE: GND	45	GDET	Connect to capacitor for demodulate G signal
14	CIN	GND: when composite signal input OPEN: other	46	GOUT	OPEN
15	COLOR	OPEN	47	BDET	Connect to capacitor for demodulate G signal
16	VCXOOUT	OPEN	48	BOUT	OPEN
17	VCXOIN	OPEN	49	SYNCSW	Synchronous signal input: 49 or 51pin.
18	APC	OPEN	50	SYNCSW	OPEN: input SYNC1 only
19	VIDEOIN	Connect with 0.01 μ F to GND	51	SYNCSW	Synchronous signal input: 49 or 51pin.
20	TRAP	OPEN	52	VS	Connect to capacitor
21	YCLAMP	OPEN	53	LPF	Connect to filter
22	YOUT	OPEN	54	VCOOUT	Connect to Ceramic Oscillation Parts
23	VCC1	Supply voltage (+5V)	55	VCOIN	Connect to Ceramic Oscillation Parts
24	YINH	Connect with 0.01 μ F to GND	56	CSYNCSW	OPEN
25	PICTURE	OPEN	57	GND1	GND
26	SW	OPEN: composite mode only	58	PWMCONT	OPEN
27	CONTRAST	Input fixed DC voltage	59	GND2	GND
28	GACLAMPB	Connect to clamp capacitor	60	PWMOUT	OPEN
29	EXTINB	OPEN	61	PWMFILTER	OPEN
30	GACLAMPG	Connect to clamp capacitor	62	REGOUT	Connect to capacitor
31	EXTING	OPEN	63	VDD	OPEN
32	GACLAMPR	Connect to clamp capacitor	64	VD	OPEN

■None-use PIN Connection

- 1) Do not use VCOM Driver
The 2pin and 3-7pin are OPEN. The 8pin connect to GND.
- 2) Do not use composite mode demodulator
The 9pin, 11pin, 15-18pin are OPEN.

The 13pin is as follows:

13pin	Mode
1V or higher	NTSC
GND	PAL

The 19pin, 24pin connect to 0.01uF with GND. The 20-22pin and 25pin are OPEN.

- 3) Do not use external analog RGB input
The 26pin, 29pin, 31pin and 33pin are OPEN.
- 4) Do not use the other SYNC IN terminal
The SYNC signal input 49pin or 51pin, either.
- 5) Do not use HD output and VD output.
The 1pin and ,64pin are OPEN.
- 6) Do not use C-SYNC output
The 56pin is OPEN.
- 7) Do not use the adjust terminal of interface and γ circuit
The 36-39pin are OPEN.
- 8) Do not use SIDE BLACK circuit.
The 42pin is OPEN.
- 9) Do not use PWM circuit
The 12pin, 58pin, 60pin and 61pin are OPEN.

■ FUNCTION DESCRIPTION

1. Synchronous Mode

1) Horizontal synchronous

There are two synchronous input terminals, first is pin-51 (SYNCIN1) and other is pin-49 (SYNCIN2). There are no difference, and selected by pin-50 (SYNCSW).

The composite-synchronous/synchronous and Y signal input to pin-51/49 either. The input (pin-51/49) signal is separate by horizontal and vertical synchronous signal. The AFC loop consists of horizontal synchronous signal and $1/32$ signal divided $32f_H$ VCO output signal without any adjustment. The pin-56 (CSYNCOU) is composite-synchronous signal output selected by pin-50, and open collector type.

2) Vertical synchronous

The countdown circuit reset the data to use vertical synchronous signal and $32f_H$ VCO output. This VD pulse is stable even if the weak-signal.

2. Color Signal Play Mode

1) ACC Circuit

The chroma signal input to pin-14 (CIN), and detect the burst-signal through the HPF circuit, and controlled stable burst-signal feedback from demodulate output. When the pin-14 is GND level, the mode is composite input, and pin-19 (VIDEOIN) composite-video signal input to ACC circuit.

2) APC Circuit, and VCXO

The burst signal level of chroma is constant by ACC circuit. The PLL circuit consists of VCXO and locked burst signal. The pin-13 (TINT) input DC voltage adjust the VCXO phase, and adjust the demodulate axis. When the pin-13 is GND, the mode is PAL, and only accepts analog RGB input.

3) Color Killer

The chroma signal is output to demodulator when PLL locked, and the color killer is -42dB .

4) Color Circuit

This circuit adjusts the color TINT. The pin-15 (COLOR) adjusts the chroma signal range from ACC circuit. This signal demodulator without burst signal by burst gate pulse (BGP).

5) DEMOD

This DEMOD circuits demodulate color differential signal after the ACC circuit. The RGB signal consists of color differential and Y signal by matrix circuit, and input to Int./Ext. signal switches.

3. Y-signal Mode

1) TRAP

The composite video signal input to pin-19 (VIDEOIN) without the chroma by TRAP circuit. The TPAP frequency is 3.58MHz, and not through when Y/C input mode.

2) Picture Circuit

The Y/composite-signal input to pin-19 (VIDEOIN) without the synchronous signal. The pin-25 (PICTURE) adjusts the frequency characteristic around 2MHz and emphasizes the outline. The pin-25 level emphasizes outline depend on the DC voltage. The Y-signal output pin-22 (YOUT), and input to pin-24 (YINH) through the external second differential circuit.

4. INT./EXT. Signal Switch Mode

The analog RGB signal ($0.7V_{P-P}$ typ.) input to pin-29, pin-31, and pin-33, and these signal clamps pedestal. The ext-signal select Y/C-signal or Int-signal by pin-26 (SW).

5. RGB SIGNAL MODE

1) Contrast

The pin-27 (CONTRAST) adjusts the all of RGB signal, which is black-to-white range.

2) γ Amplifier

This circuit is non-linear amplifier to adjust the RGB signal equal to the luminous γ characteristics. There is two-point adjustment for accurate correction. The pin-38 (VG1) adjusts low side, and the pin-39 (VG2) adjusts high side.

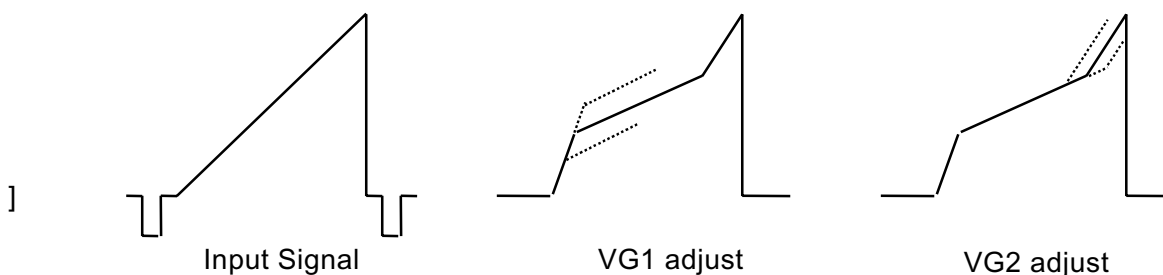

3) Sub γ Circuit

This circuit adjusts γ characteristics of B/R signal, and sub γ adjusts white-balance for the monitor. The pin-38 (SUBVG1R) and pin-36 (SUBVG2R) adjust low side with R-signal and high side with γ characteristics. The pin-39 (SUBVG1B) and pin-37 (SUBVG2B) adjust low side with B-signal and high side for γ characteristics. These terminal controls R-signal and B-signal separately.

4) Bright

The pin-27 (CONTRAST) clamps the pedestal after the brightness adjustment (black to black).

5) Side Black

The side-black circuit output black level, when the mode is black mask for wide picture.
The RGB signal is black level when pin-42 (SIDEBLACK) input signal is low period only.

6) Output Amplifier

The pin-41 (FRP) input to the timing pulse with inverting RGB output, and output the inverting RGB signal per every 1H. The RGB outputs are:

FRP-High: Non-inverting output

FRP-Low: Inverting output

The center voltage is preset to half of V_{cc} .

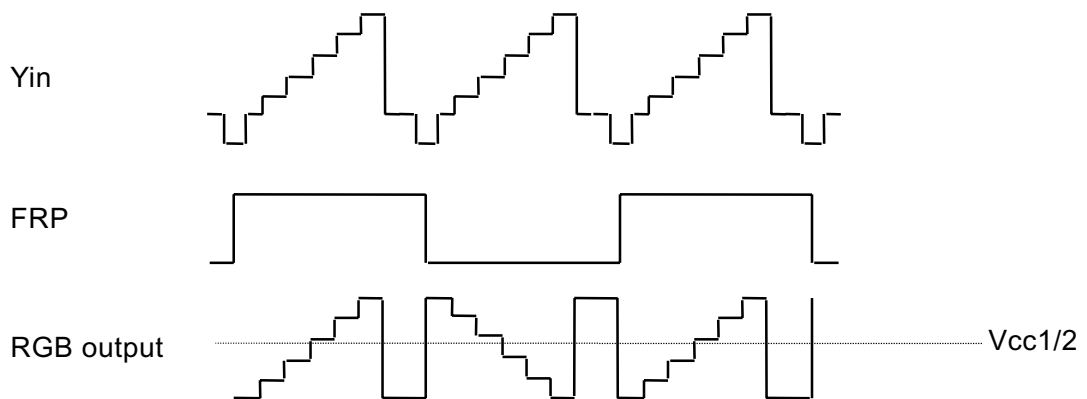

6. Common Driver

The LCD common invert RGB output, and the pin-4 (VCOMIN) input to the common driver signal ($5V_{P-P}$). The pin-2 (VCOMAMP) adjusts the range, the pin-5 (VCOMCENT) adjusts the center voltage. The pin-7 (VCOMOUT) connect external discreet buffer, and feedback the buffer output for pin-6 (VCOMFB).

7. PWM Signal for Backlight

The pin-60 (PWMOUT) output the PWM signal for LCD backlight, open collector type, and connect pull-up resistor. The pin-58 (PWMOUT) adjusts the PWM duty.

MEMO

[CAUTION]

The specifications on this databook are only given for information, without any guarantee as regards either mistakes or omissions. The application circuits in this databook are described only to show representative usages of the product and not intended for the guarantee or permission of any right including the industrial rights.