

QUARTZ CRYSTAL OSCILLATOR

■ GENERAL DESCRIPTION

The NJU6333 series is a C-MOS quartz crystal oscillator which consists of an oscillation amplifier and a 3-state output buffer.

This series are classed into three versions A, H and Q according to their oscillation frequency range mentioned in the line-up table.

The oscillation amplifier incorporates feed-back resistance and oscillation capacitors(Cg, Cd), therefore, it requires no external component except quartz crystal.

Driverbility of the 3-state output buffer is 24mA (sink/source), thus it can drive both of TTL and C-MOS load.

■ PACKAGE OUTLINE



NJU6333XC



NJU6333XE

■ PIN CONFIGURATION/PAD LOCATION

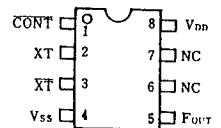
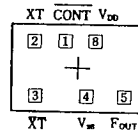

■ FEATURES

- Operating Voltage. -- 4.0~6.0V
- Maximum Oscillation Frequency (See Line-Up Table)
- Low Operating Current
- High Fan-out -- $I_{OL}/I_{OH}=24mA$
- 3-state Output Buffer
- Oscillation Capacitors Cg and Cd on-chip
- Oscillation and/or Output Stand-by Function
- Package Outline -- CHIP / EMP 8
- C-MOS Technology

■ LINE-UP TABLE

Type No.	Recommended Osc. Freq.	Output Freq.	Cg, Cd
NJU6333A	20~35MHz	fo	28pF
6333H	30~50MHz		20pF
6333Q	45~75MHz		17pF

■ COORDINATES

Unit: μm

No.	PAD	X	Y
1	CONT	-130	248
2	XT	-414	248
3	XT	-414	-232
4	VSS	89	-248
5	FOUT	446	-228
8	VDD	153	228

■ BLOCK DIAGRAM

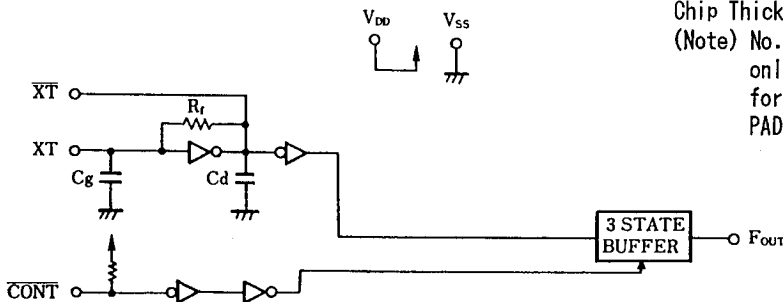

Chip Size : 1.29 X 0.8mm
 Chip Center : X=0 μm , Y=0 μm
 Chip Thickness : 400 $\mu m \pm 30\mu m$
 (Note) No. 6 and 7 terminals are only for package type information. There are no PAD on the chip.

■ TERMINAL DESCRIPTION

NO.	SYMBOL	F U N C T I O N	
1	CONT	3-State Output Control	
		CONT	Output (F_{OUT})
		H	Output Frequency f_o
		L	Output High Impedance
2	XT	Quartz Crystal Connecting Terminals	
3	XT		
4	V_{SS}	GND	
5	F_{OUT}	Output frequency f_o	
8	V_{DD}	+ 5V	

4
■ ABSOLUTE MAXIMUM RATINGS

 ($T_a=25^{\circ}\text{C}$)

P A R A M E T E R	SYMBOL	R A T I N G S	UNIT
Supply Voltage	V_{DD}	-0.5 ~ +7.0	V
Input Voltage	V_{IN}	$V_{SS}-0.5 \sim V_{DD}+0.5$	V
Output Voltage	V_o	-0.5 ~ $V_{DD}+0.5$	V
Input Current	I_{IN}	± 10	mA
Output Current	I_o	± 25	mA
Power Dissipation	P_D	200 (EMP)	mW
Operating Temperature Range	T_{opr}	-40 ~ +85	$^{\circ}\text{C}$
Storage Temperature Range	T_{stg}	-55 ~ +125	$^{\circ}\text{C}$

(Note) Decoupling capacitor should be connected between V_{DD} and V_{SS} due to the stabilized operation for the circuit.

■ ELECTRICAL CHARACTERISTICS

 ($T_a=25^{\circ}\text{C}$, $V_{DD}=5\text{V}$)

P A R A M E T E R	SYMBOL	C O N D I T I O N S	MIN	TYP	MAX	UNIT
Operating Voltage	V_{DD}		4		6	V
Operating Current	I_{DD1}	A Version $f_{osc}=24\text{MHz}$, No Load			25	mA
	I_{DD2}	H Version $f_{osc}=48\text{MHz}$, No Load			30	
	I_{DD3}	Q Version $f_{osc}=48\text{MHz}$, No Load			35	
Stand-by Current	I_{st}	CONT, XT= V_{SS} , No Load (Note)			1	μA
Input Voltage	V_{IH}		3.5		5.0	V
	V_{IL}		0		1.5	
Output Current	I_{OH}	$V_{DD}=5\text{V}$, $V_{OH}=4.5\text{V}$	24			mA
	I_{OL}	$V_{DD}=5\text{V}$, $V_{OL}=0.5\text{V}$	24			
Input Current	I_{IN}	CONT Terminal, CONT= V_{SS}	125	250	500	μA
3-St Off-leakage Current	I_{oz}	CONT= V_{SS} , $F_{OUT}=V_{SS}$ or V_{DD}			± 0.1	μA
Internal Capacitor	C_g, C_d	A Version		28		pF
		H Version		20		
		Q Version		17		
Max. Oscillation Freq.	f_{MAX}	A Version	35			MHz
		H Version	50			
		Q Version	75			
Output Signal Symmetry	SYM	$C_L=15\text{pF}$ at 1.4V	45	50	55	%
		$C_L=15\text{pF}$ at 2.5V				
Output Signal Rise Time	t_{r1}	$C_L=15\text{pF}$, $R_L=390\Omega$, 20%~80%		2		ns
		$C_L=15\text{pF}$, $R_L=390\Omega$, 0.4~2.4V		2		
		$C_L=15\text{pF}$, 10~90%		3		
Output Signal Fall Time	t_{f1}	$C_L=15\text{pF}$, $R_L=390\Omega$, 80%~20%		2		ns
		$C_L=15\text{pF}$, $R_L=390\Omega$, 2.4~0.4V		2		
		$C_L=15\text{pF}$, 90~10%		3		

(Note) Excluding input current on CONT terminal.

MEASUREMENT CIRCUITS

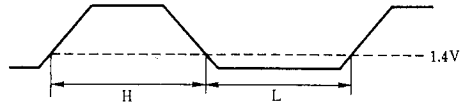
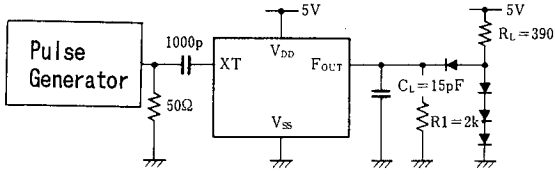
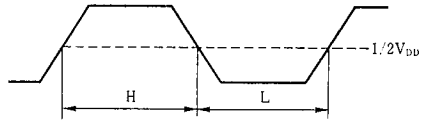
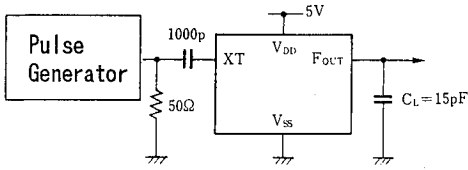
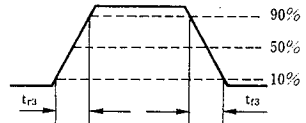
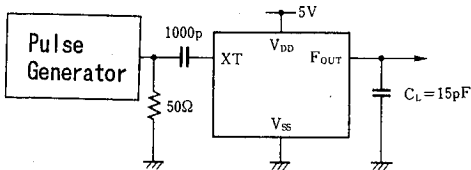
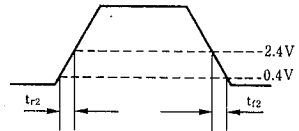
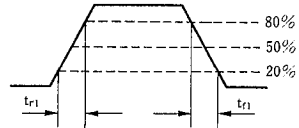
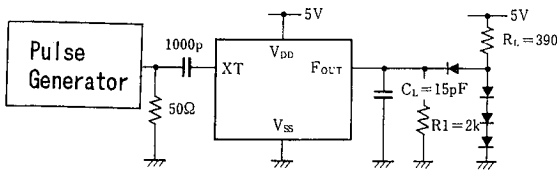
 (1) Output Signal Symmetry ($C_L=15\text{pF}$)

4

 (2) Output Signal Rise / Fall Time ($C_L=15\text{pF}$)

NJU6333 Series

MEMO

[CAUTION]

The specifications on this databook are only given for information, without any guarantee as regards either mistakes or omissions. The application circuits in this databook are described only to show representative usages of the product and not intended for the guarantee or permission of any right including the industrial rights.