

## Passive Matrix TruSurround™ 3D AUDIO PROCESSOR

### ■GENERAL DESCRIPTION

The NJM2181 is a Passive Matrix TruSurround™ 3D audio processor. It regenerates the full surround soundfield directly from any kinds of surround encoded stereo input (Lt/Rt) signals.

After the internal passive matrix circuit decodes Lt/Rt signal into 4 channel signals, the TruSurround virtualizer re-encodes them into 2 channel surround signals. Accordingly any pre-processors decoding into 4 channel signals are not required.

The NJM2181 also includes SRS 3D Stereo and 3D Mono, and regenerates a 3D sound field from either normal L/R input or monoural input.

The NJM2181 is suitable for TV, mini component, CD radio cassette, multimedia speaker system, and others.

### ■PACKAGE OUTLINE

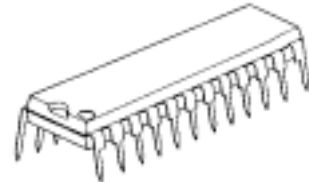

NJM2181L

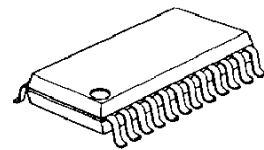

NJM2181M

### ■FEATURES

- Operating Voltage (4.7 to 13V)
- Maximum input Voltage (1.5Vrms typ. at TruSurround)
- Low Output Noise (32μVrms typ. at TruSurround)
- BYPASS Gain (0dB typ.)
- Passive Matrix TruSurround
- SRS 3D Stereo & 3D Mono (Two-grade Switch for 3D Effect)
- BYPASS FUNCTION (Through)
- Bipolar Technology
- Package Outline SDIP24, DMP24

The SRS, TruSurround technology right incorporated in the NJM2181 are owned by SRS Labs, a U.S. Corporation and licensed to New Japan Radio Co., Ltd. SRS, TruSurround is protected under U.S. and foreign patents issued and/or pending. SRS, TruSurround and the are trademarks of SRS Labs, Inc. in the United States and selected foreign countries. Neither the purchase of the NJM2181, nor the corresponding sale of audio enhancement equipment conveys the right to sell commercialized recordings made with any SRS technology.

SRS Labs requires that all users of the NJM2181 must enter into a license agreement directly with SRS Labs if the royalty is not included in the purchase price. SRS Labs also requires any users to comply with all rules and regulations as outlined in the SRS Trademark Usage Manual.

For further information, please contact:  
 SRS Labs, Inc.  
 2909 Daimler Street, Santa Ana, CA 92705 USA  
 Tel:949-442-1070 Fax:949-852-1099 <http://www.srslabs.com>

# NJM2181

## ■ABSOLUTE MAXIMUM RATING (Ta=25°C)

PARAMETER	SYMBOL	RATINGS	UNIT
Supply Voltage	V <sup>+</sup>	15	V
Power Dissipation	P <sub>D</sub>	(SDIP24) 700 (DMP24) 700	mW
Operating Temperature Range	T <sub>opr</sub>	-30 to +85	°C
Storage Temperature Range	T <sub>stg</sub>	-40 to +125	°C

## ■ELECTRICAL CHARACTERISTICS (Ta=25°C, V<sup>+</sup>=9V, V<sub>IN</sub> =-10dBV(316mVrms))

PARAMETER	SYMBOL	TEST CONDITION	TEST CONDITION				MIN.	TYP.	MAX.	UNIT
			INPUT		OUT PUT	MODE				
			L	R						
Operating Voltage	V <sup>+</sup>		-	-	-	-	4.7	9.0	13.0	V
Supply Current	I <sub>CC</sub>	No Signal	-	-	-	BYPASS	6.3	12.5	18.8	mA
			-	-	-	TRU				
			-	-	-	3D Stereo1				
			-	-	-	3D Mono				
Reference Voltage	V <sub>REF</sub>	V <sup>+</sup> /2	-	-	-	-	4.3	4.5	4.7	V
Maximum Input Voltage	V <sub>IM</sub>	f=1kHz THD=3%	V <sub>IN</sub>	-	L	BYPASS	6.8 (2.2)	8.8 (2.8)	-	dBV (Vrms)
			-	V <sub>IN</sub>	R					
		f=125Hz THD=3%	V <sub>IN</sub>	-	L	TRU	1.5 (1.2)	3.5 (1.5)	-	
			V <sub>IN</sub>	-	R	3D Stereo1	3.6 (1.5)	5.6 (1.9)	-	
			V <sub>IN</sub>	-	R	3D Stereo2	3.6 (1.5)	5.6 (1.9)	-	
f=1kHz THD=3%	V <sub>IN</sub>	-	L	3D Mono	-7.6 (0.4)	-3.0 (0.7)	-			
Channel Balance	CH <sub>BAL</sub>	f=1kHz L-R OUT	-	V <sub>IN</sub>	L	3D Stereo1	-1.0	0.0	1.0	dB
			V <sub>IN</sub>	-	R					
OutputNoise Voltage	V <sub>NOISE</sub>	Rg=0Ω A-Weighted	0	0	L R	TRU	-	-90 (31.6)	-85 (56.2)	dBV (μVrms)
		Rg=0Ω A-Weighted	0	0	L R	3D Stereo1	-	-90 (31.6)	-85 (56.2)	
		Rg=0Ω A-Weighted	0	0	L R	3D Mono	-	-90 (31.6)	-85 (56.2)	
Total Harmonic Distortion	THD	f=1kHz	V <sub>IN</sub>	-	L	TRU	0.10			
			-	V <sub>IN</sub>	R					
		f=1kHz	V <sub>IN</sub>	-	L	3D Stereo1	0.10			
			-	V <sub>IN</sub>	R					
		f=1kHz	V <sub>IN</sub>	-	L	3D Mono	0.10			
			-	V <sub>IN</sub>	R					
Bypass Gain	G <sub>VBYP</sub>	f=1kHz	V <sub>IN</sub>	-	L	BYPASS	-1.0	0.0	1.0	dB
			-	V <sub>IN</sub>	R					

**■ELECTRICAL CHARACTERISTICS** (Ta=25°C, V+=9V, V<sub>IN</sub> =-10dBV(316mVrms))

PARAMETER	SYMBOL	TEST CONDITION				MIN.	TYP.	MAX.	UNIT
		INPUT		OUT PUT	MODE				
		L	R						
SRS Gain	G <sub>SRS</sub>	f=1kHz	V <sub>IN</sub>	-	L	TRU	0.2	2.2	4.2
			-	V <sub>IN</sub>	R				
		f=1kHz	-	V <sub>IN</sub>	L	TRU	-13.5	-11.5	-9.5
			V <sub>IN</sub>	-	R				
		f=1kHz	V <sub>IN</sub>	-	L	3D Stereo1	-4.8	-2.8	-0.8
			-	V <sub>IN</sub>	R				
		f=1kHz	-	V <sub>IN</sub>	L	3D Stereo1	-15.0	-13.0	-11.0
			V <sub>IN</sub>	-	R				
		f=1kHz	V <sub>IN</sub>	-	L	3D Stereo2	-5.8	-3.8	-1.8
			-	V <sub>IN</sub>	R				
		f=1kHz	-	V <sub>IN</sub>	L	3D Stereo2	-21.0	-19.0	-17.0
			V <sub>IN</sub>	-	R				
		f=1kHz	V <sub>IN</sub>	V <sub>IN</sub>	L	3D Mono	1.3	3.3	5.3
			V <sub>IN</sub>	V <sub>IN</sub>	R		-6.9	-4.9	-2.9
Mode Select Control Voltage	V <sub>MODE</sub>	Vin=High Level				2.0	-	V+	V
		Vin=Low Level				0.0	-	0.7	

**■MODE SWITCH**

MODE	MODE1	MODE2	MODE3
BYPASS	L	L	-
TRU	L	H	-
3D Stereo1	H	L	L
3D Sterteo2	H	L	H
3D Mono	H	H	-

# NJM2181

## ■PIN FUNCTION

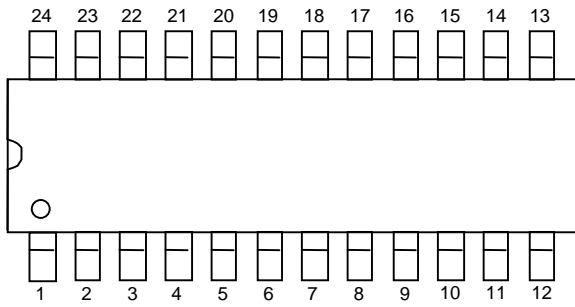

1.FIL1	13 GND
2.FIL2	14 VREFOUT
3.FIL3	15 VREFIN
4.FIL4	16 VCC
5.FIL5	17 ROUT
6.FIL6	18 LOUT
7.FIL7	19 FIL10
8.FIL8	20 FIL11
9.FIL9	21 FIL12
10.MODE1	22 FIL13
11.MODE2	23 RIN
12.MODE3	24 LIN

## ■BLOCK DIAGRAM

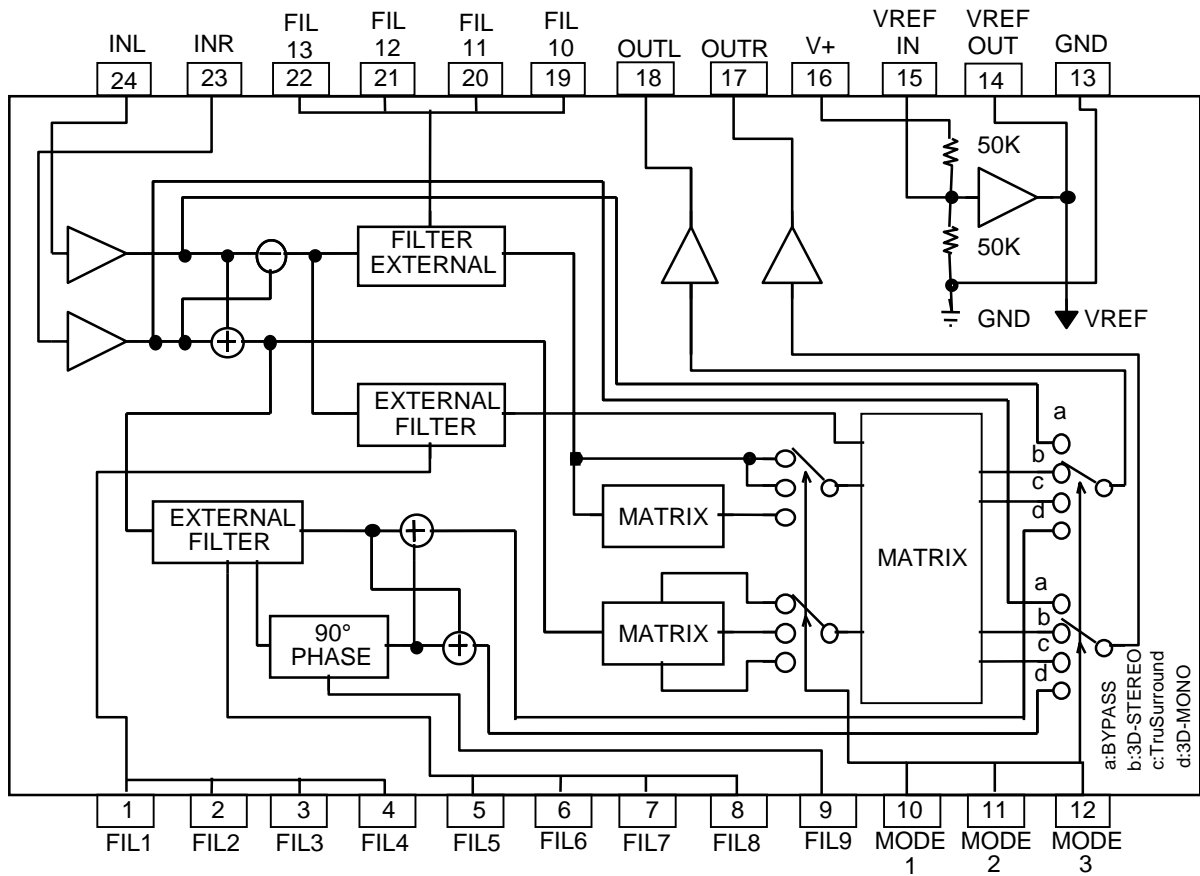

## APPLICATION CIRCUIT

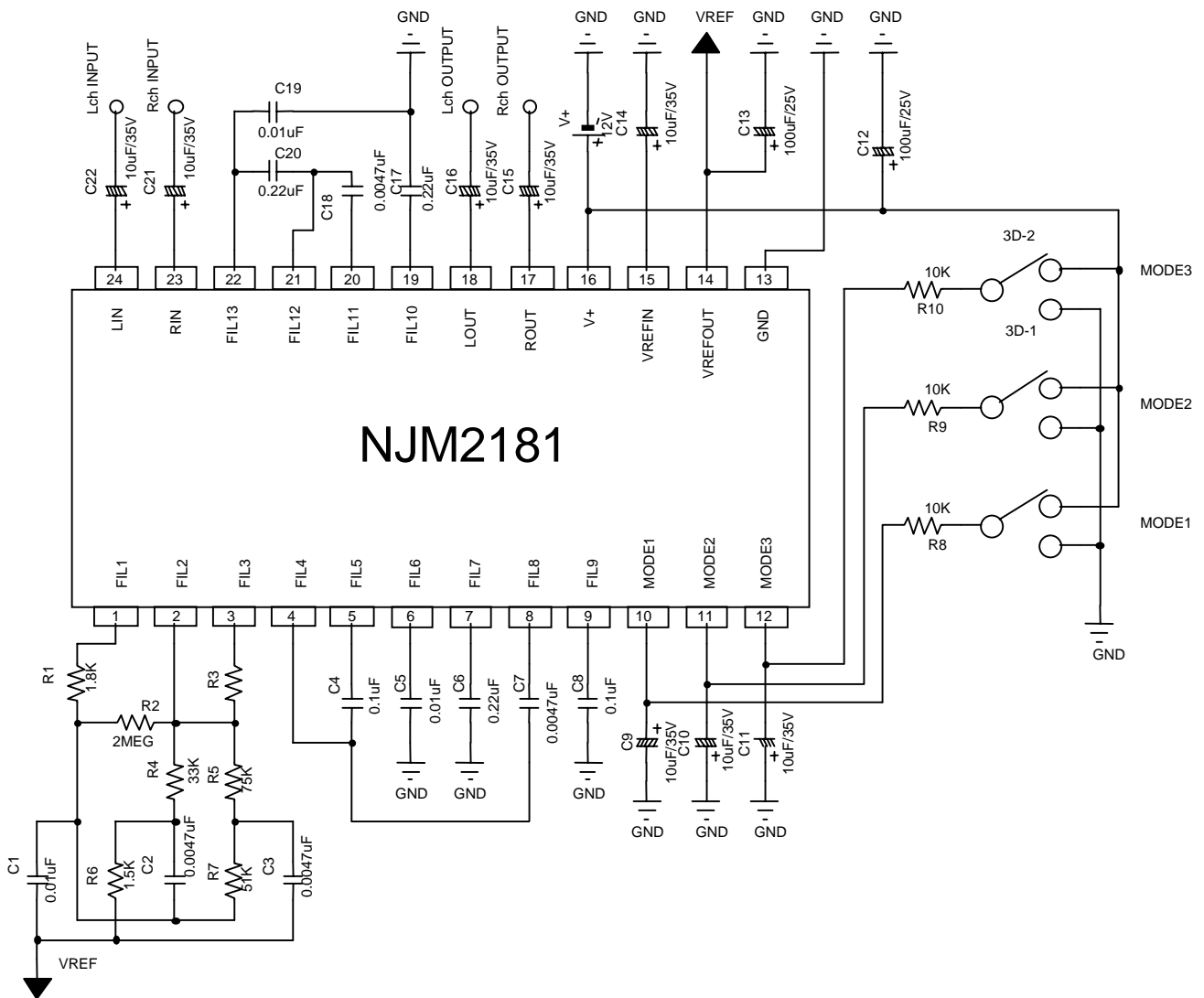

# NJM2181

## TYPICAL CHARACTERISTICS

FREQUENCY RESPONSE  
BYPASS Mode

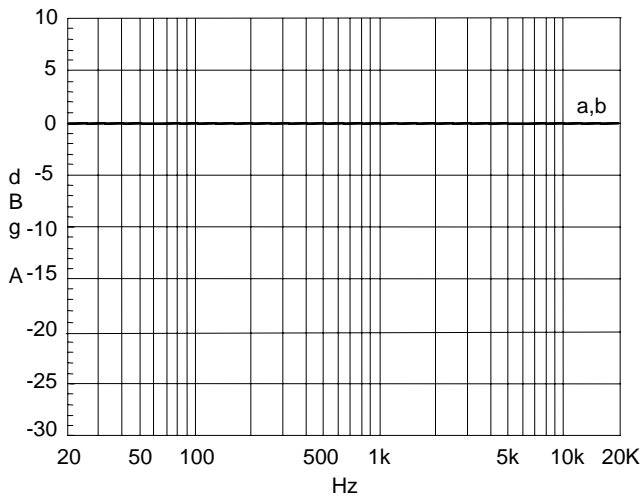

a: Vin= -12.2dBv Lch → Vout= Lch  
 b: Vin= -12.2dBv Rch → Vout= Rch  
 V+=9v 0dBv=1Vrms

FREQUENCY RESPONSE  
TRU Mode

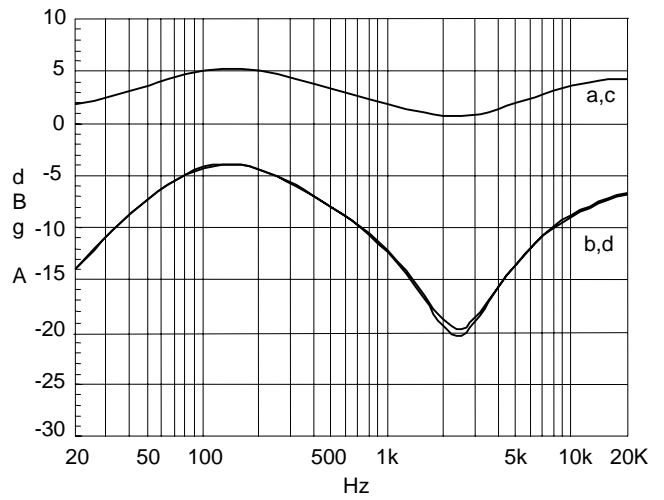

a: Vin= -12.2dBv Lch → Vout= Lch  
 b: Vin= -12.2dBv Lch → Vout= Rch  
 c: Vin= -12.2dBv Rch → Vout= Rch  
 d: Vin= -12.2dBv Rch → Vout= Lch  
 V+=9v 0dBv=1Vrms

FREQUENCY RESPONSE  
3D Stereo1 Mode

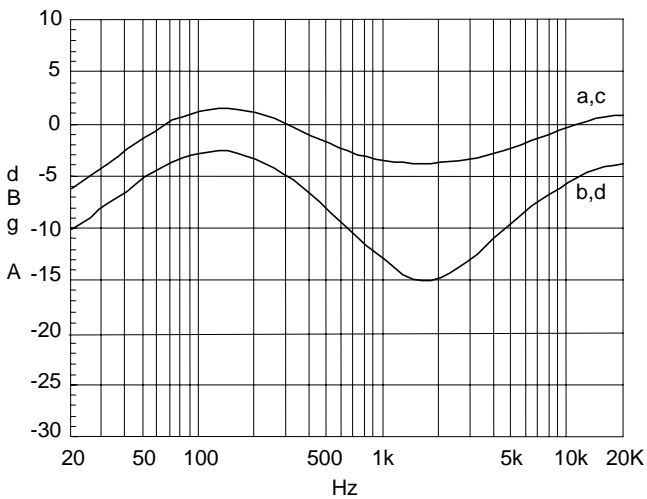

a: Vin= -12.2dBv Lch → Vout= Lch  
 b: Vin= -12.2dBv Lch → Vout= Rch  
 c: Vin= -12.2dBv Rch → Vout= Rch  
 d: Vin= -12.2dBv Rch → Vout= Lch  
 V+=9v 0dBv=1Vrms

FREQUENCY RESPONSE  
3D Stereo2 Mode

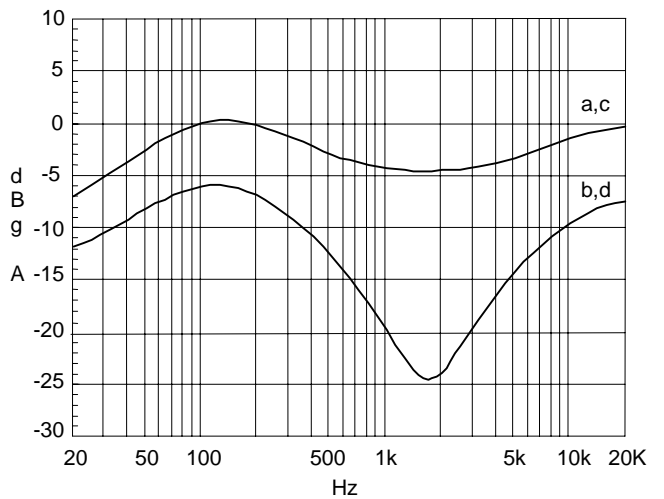

a: Vin= -12.2dBv Lch → Vout= Lch  
 b: Vin= -12.2dBv Lch → Vout= Rch  
 c: Vin= -12.2dBv Rch → Vout= Rch  
 d: Vin= -12.2dBv Rch → Vout= Lch  
 V+=9v 0dBv=1Vrms

## TYPICAL CHARACTERISTICS

FREQUENCY RESPONSE  
3D Mono Mode

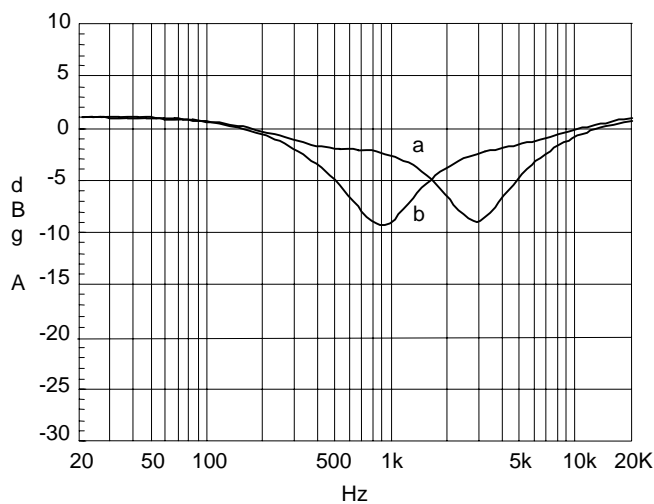

a: Vin= -12.2dBV Lch → Vout= Lch  
b: Vin= -12.2dBV Lch → Vout= Rch  
V+=9v 0dBv=1Vrms

T.H.D. vs INPUT LEVEL  
BYPASS Mode

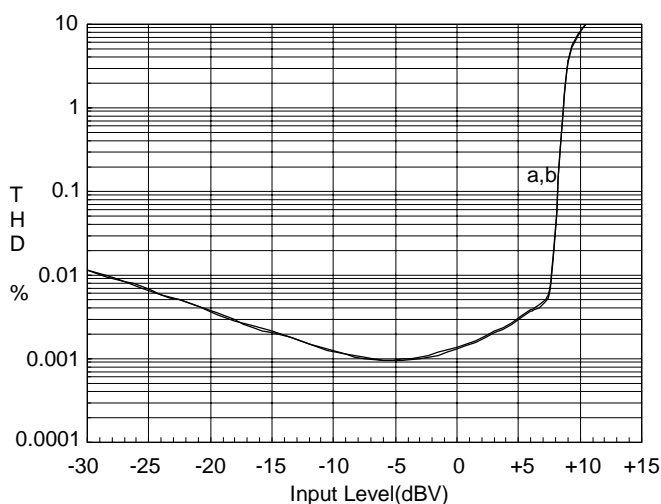

a: Vin= 1KHz Lch → Vout= Lch  
b: Vin= 1KHz Rch → Vout= Rch  
V+=9v , Measurement: Input level

T.H.D. vs INPUT LEVEL  
TRU Mode

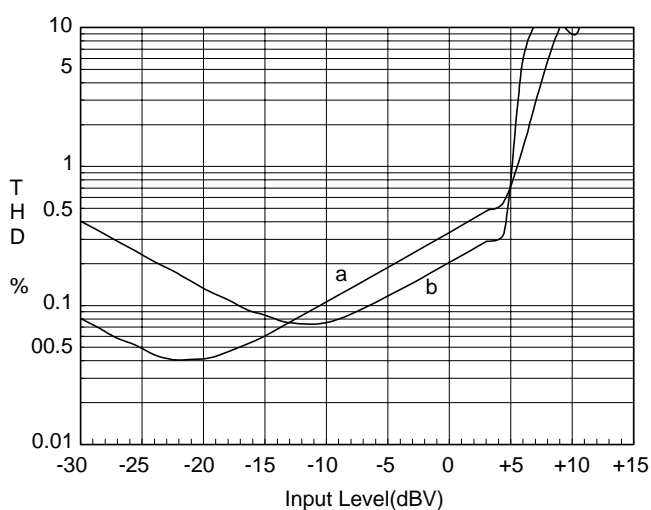

a: Vin= 1KHz Lch → Vout= Lch  
b: Vin= 1KHz Lch → Vout= Rch  
V+=9v , Measurement: Input level

T.H.D. vs INPUT LEVEL  
3D Stereo1 Mode

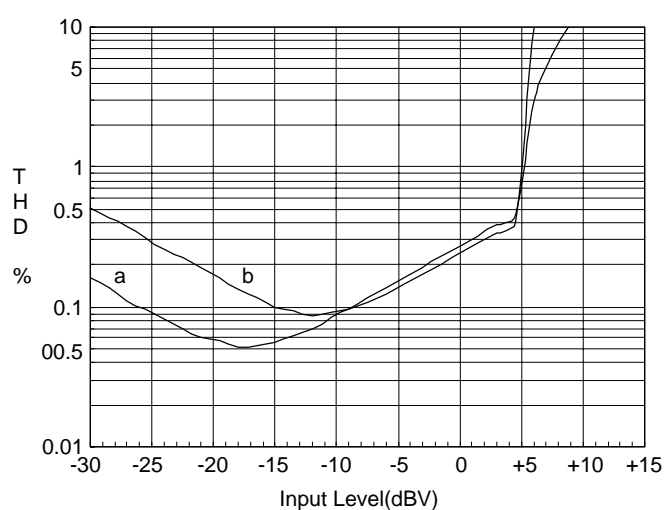

a: Vin= 1KHz Lch → Vout= Lch  
b: Vin= 1KHz Lch → Vout= Rch  
V+=9v , Measurement: Input level

# NJM2181

## TYPICAL CHARACTERISTICS

T.H.D. vs INPUT LEVEL  
3D Stereo2 Mode

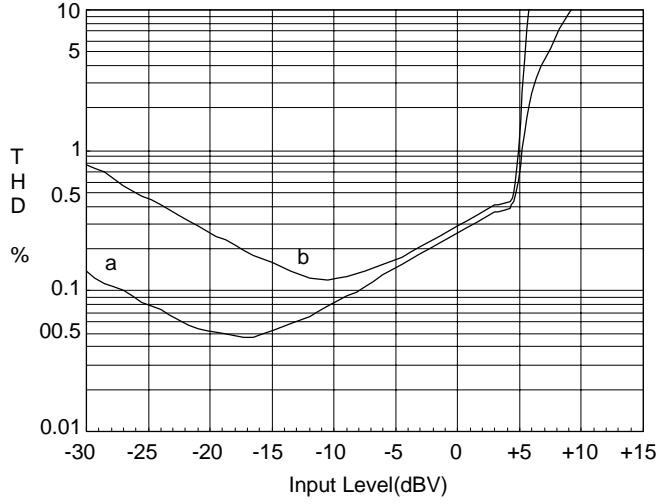

a: Vin= 1KHz Lch → Vout= Lch  
 b: Vin= 1KHz Lch → Vout= Rch  
 V+=9v , Measurement: Input level

T.H.D. vs INPUT LEVEL  
3D Mono Mode

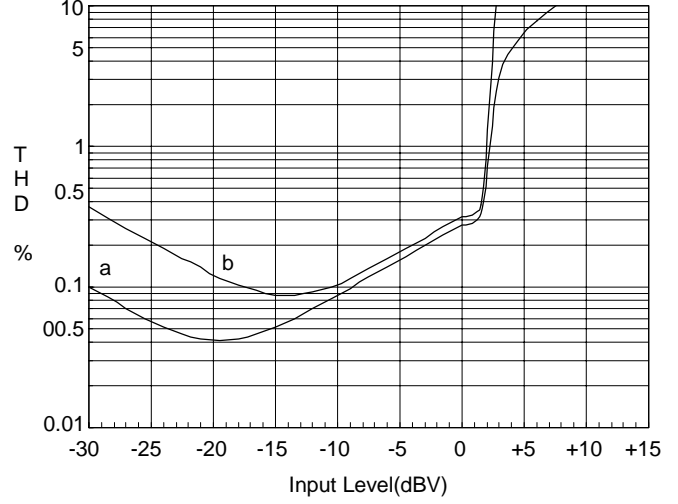

a: Vin= 1KHz Lch → Vout= Lch  
 b: Vin= 1KHz Lch → Vout= Rch  
 V+=9v , Measurement: Input level

[CAUTION]  
 The specifications on this databook are only given for information , without any guarantee as regards either mistakes or omissions. The application circuits in this databook are described only to show representative usages of the product and not intended for the guarantee or permission of any right including the industrial rights.