



AUDIO PROCESSOR with Input Selector and Subwoofer Output

■ GENERAL DESCRIPTION

The **NJW1168** is a sound processor with subwoofer output includes all of functions processing audio signal for TV, such as input selector, tone control, balance, volume, mute, and AGC functions.

Also the **NJW1168** includes the LPF for subwoofer output and bass boost function.

The eala reproduces a natural surround sound with clear vocal orientation. And also, voice enhancement gives clear sound such as dialogs.

All of internal status and variables are controlled by I²C BUS interface.

■ PACKAGE OUTLINE

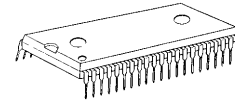

NJW1168L

■ FEATURES

- Operating Voltage 7.5 to 13V
- 3ch Output(Lch, Rch, Subwoofer ch) / 2ch Output(Lch, Rch)
- 4ch Input Selector
- LPF Filter (Adjustable cut off frequency by external parts)
- AGC Circuit (It reduces volume difference among input sources.)
Adjustable AGC compression level by I²C BUS
- eala(NJRC Original Surround System)
- Simulated Stereo
- Voice Enhancement System
- I²C BUS Interface
- Bi-CMOS Technology
- Package Outline SDIP42

■ BLOCK DIAGRAM

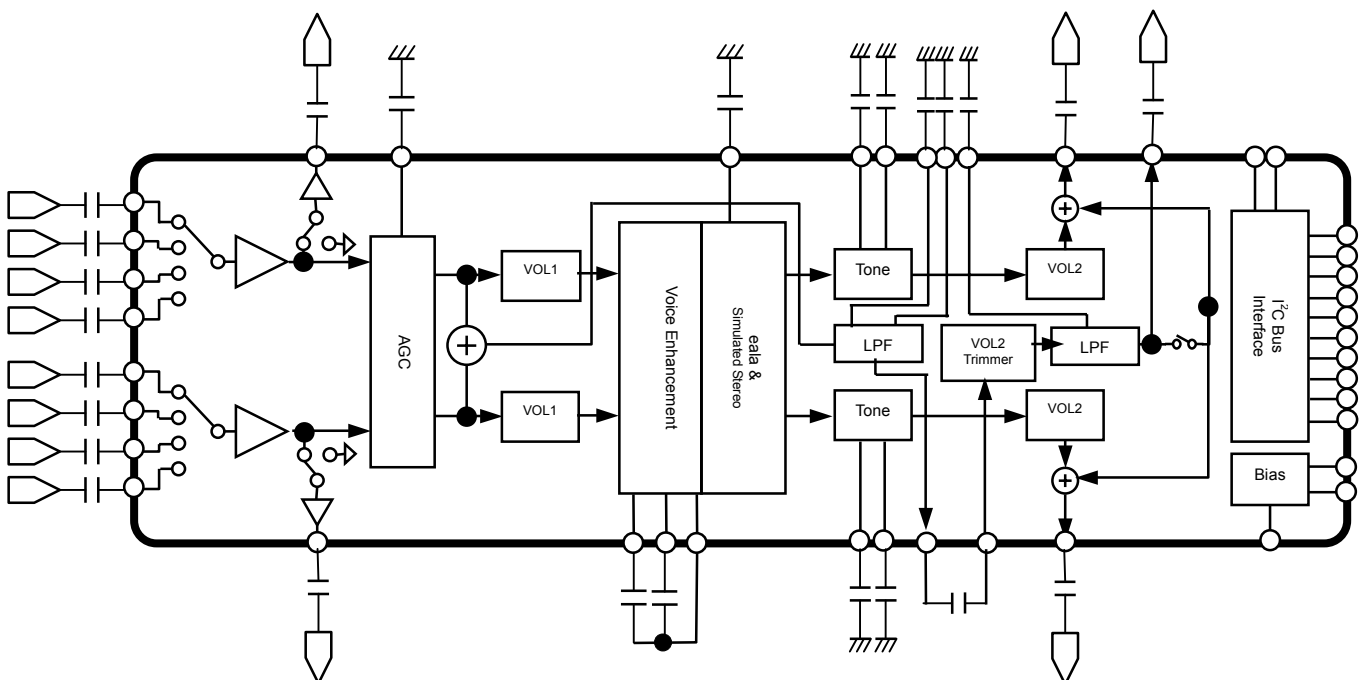

■ PIN FUNCTION

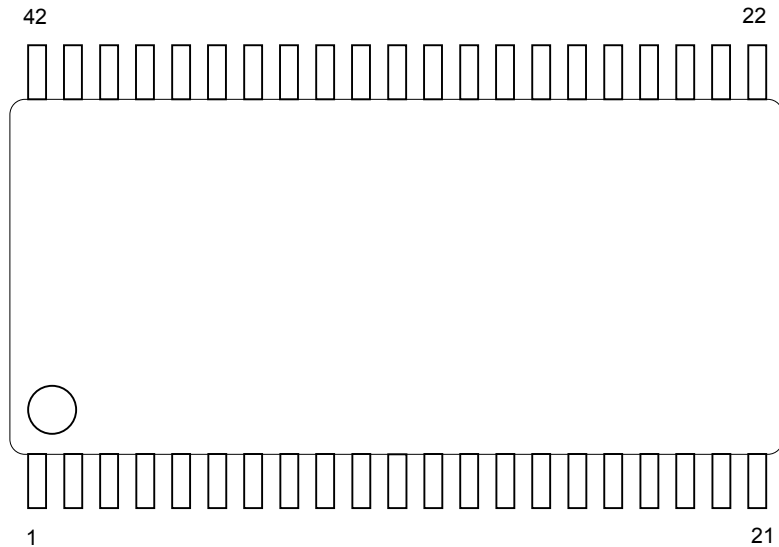

No.	SYMBOL	FUNCTION	No.	SYMBOL	FUNCTION
1	IN1a	A ch Input 1	22	V+	Power Supply
2	IN2a	A ch Input 2	23	VREF	Reference Voltage stabilizing Capacitor
3	IN3a	A ch Input 3	24	CTL	Tone Control Bass switching noise rejection Capacitor
4	IN4a	A ch Input 4	25	CTH	Tone Control Treble switching noise rejection Capacitor
5	MONa	A ch Input Selector Monitor Output	26	CVw	SWch Trimmer switching noise rejection Capacitor
6	CMON	MONa/b switching noise rejection Capacitor	27	CVb	Bch Volume switching noise rejection Capacitor
7	LF1	Low Pass Filter Capacitor 1	28	OUTb	Bch Output
8	OUTw	Sub Woofer Output	29	TONE-Lb	Bch TONE Bass Filter Capacitor
9	VE-FIL3	Voice Enhancement Filter Capacitor 3	30	TONE-Hb	Bch TONE Treble Filter Capacitor
10	VE-FIL2	Voice Enhancement Filter Capacitor 2	31	CSR	eala switching noise rejection Capacitor
11	VE-FIL1	Voice Enhancement Filter Capacitor 1	32	eala-FIL	eala Filter Capacitor
12	CVE	VE switching noise rejection Capacitor	33	AGC	AGC Smoothing Filter Capacitor
13	TONE-Ha	Ach TONE Treble Filter Capacitor	34	DCC2	Coupling Capacitor 2
14	TONE-La	Ach TONE Bass Filter Capacitor	35	DCC1	Coupling Capacitor 1
15	OUTa	Ach Output	36	LF2	Low Pass Filter Capacitor 2
16	CVa	Ach Volume switching noise rejection Capacitor	37	LF3	Low Pass Filter Capacitor 3
17	AUX0	Auxiliary Output 0	38	MONb	B ch Input Selector Monitor Output
18	AUX1	Auxiliary Output 1	39	IN4b	B ch Input 4
19	SDA	I ² C Data Input	40	IN3b	B ch Input 3
20	SCL	I ² C Clock Input	41	IN2b	B ch Input 2
21	GND	Ground	42	IN2b	B ch Input 1

■ **ABSOLUTE MAXIMUM RATING (Ta=25°C)**

PARAMETER	SYMBOL	RATING	UNIT
Supply Voltage	V ⁺	15	V
Power Dissipation	P _D	700	mW
Operating Temperature Range	Topr	-20 to +75	°C
Storage Temperature Range	Tstg	-40 to +125	°C

■ **ELECTRICAL CHARACTERISTICS**

(Ta=25°C, V+=9V, R_L=47kΩ, Vin=100mVrms/1kHz unless otherwise specified)

PARAMETER	SYMBOL	Condition	Input			Output	MIN.	TYP.	MAX.	UNIT
			INa	INb						
Operating Voltage	V ⁺		-	-	-	7.5	9.0	13.0	V	
Supply Current	I _{CC}	No Signal	-	-	-	-	13	25	mA	
Reference Voltage	V _{REF}	No Signal	-	-	-	4.0	4.5	5.0	V	
Maximum Input Voltage	V _{IM}	VOL=-20dB, THD=1%	V _{in}	-	OUTa	2.8	3.0	-	Vrms	
			-	V _{in}	OUTb					
			-	V _{in}	OUTb					
Maximum Output Voltage	V _{OM}	VOL=0dB, THD=1%	V _{in}	-	OUTa	-	2.5	-	Vrms	
			-	V _{in}	OUTb					
Monitor Output Gain	G _{VMON}	MON OUT	V _{in}	-	OUTa	-	2.5	-	dB	
			-	V _{in}	OUTb					
Channel Balance	G _{CB}	VOL=0dB	-	-	-	-1.5	0.0	1.5	dB	
Balance Boost A	BA _{BST}	CHS="0", BAL="111111"	V _{in}	V _{in}	OUTa	-2.0	0.0	2.0	dB	
Balance Cut A	BA _{CUT}	CHS="1", BAL="111111" Vin = 1Vrms	V _{in}	V _{in}	OUTa	-	-	-70	dB	
Balance Boost B	BB _{BST}	CHS="1", BAL="111111"	V _{in}	V _{in}	OUTb	-2.0	0.0	2.0	dB	
Balance Cut B	BB _{CUT}	CHS="0", BAL="111111" Vin = 1Vrms	V _{in}	V _{in}	OUTb	-	-	-70	dB	
Trimmer Boost	TR _{BST}	VOL=0dB, f=50Hz TRIM = +30dB	V _{in}	V _{in}	OUTw	28.0	30.0	32.0	dB	
Trimmer Cut	TR _{CUT}	VOL=0dB, f=50Hz TRIM = -6dB	V _{in}	V _{in}	OUTw	-11.0	-6.0	-1.0	dB	
Total Harmonic Distortion	THD	Vo=0.5Vrms, BW=400Hz to 30kHz	V _{in}	-	OUTa	-	-	0.5	%	
			-	V _{in}	OUTb					
Maximum Gain	G _{VMAX}	VOL=0dB	V _{in}	-	OUTa	-2.0	0.0	2.0	dB	
			-	V _{in}	OUTb					
Minimum Gain	G _{VMIN}	VOL=MUTE Vin=1Vrms	V _{in}	-	OUTa	-	-	-80	dB	
			-	V _{in}	OUTb					
Cross Talk	CT	Vin=1Vrms BW=400Hz to 30kHz Selected Input : No signal Unselected Inputs : Signal	V _{in}	-	OUTa	-	-	-70	dB	
			-	V _{in}	OUTb					
Channel Separation	CS	Vin=1Vrms BW=400Hz to 30kHz	V _{in}	-	OUTb	-	-80	-70	dB	
			-	V _{in}	OUTa					
Output Noise Voltage 1	V _{NO1}	VOL=0dB A-Weighted	-	-	-	-	-90 (31.6)	-85 (56.2)	dBV (μVrms)	
Output Noise Voltage 2	V _{NO2}	VOL=MUTE A-Weighted	-	-	-	-	-106 (5.0)	-96 (15.8)	dBV (μVrms)	
Output Noise Voltage 3	V _{NO3}	VOL=MUTE, TRIM=MUTE A-Weighted	-	-	-	-	-100 (10.0)	-90 (30.0)	dBV (μVrms)	

BW : Band Width

■ ELECTRICAL CHARACTERISTICS

(Ta=25°C, V+=9V, RL=47kΩ, Vin=100mVrms/1kHz unless otherwise specified)

PARAMETER	SYMBOL	Condition	Input			Output	MIN.	TYP.	MAX.	UNIT
			INa	INb						
◆TONE										
High Frequency Boost	HF _{BST}	BCT="1" TREB=+15dB, f=10kHz	V _{in}	-	OUTa	12.5	15.0	17.5	dB	
			-	V _{in}	OUTb					
High Frequency Flat	HF _{FLT}	TREB=0, f=10kHz	V _{in}	-	OUTa	-2.0	0.0	2.0	dB	
			-	V _{in}	OUTb					
High Frequency Cut	HF _{CUT}	BCT="0" TREB=-15dB, f=10kHz	V _{in}	-	OUTa	-17.5	-15.0	-12.5	dB	
			-	V _{in}	OUTb					
Low Frequency Boost	LF _{BST}	BCB="1" BASS=+15dB, f=100Hz	V _{in}	-	OUTa	12.5	15.0	17.5	dB	
			-	V _{in}	OUTb					
Low Frequency Flat	LF _{FLT}	BASS=0, f=100Hz	V _{in}	-	OUTa	-2.0	0.0	2.0	dB	
			-	V _{in}	OUTb					
Low Frequency Cut	LF _{CUT}	BCB="0" BASS=-15dB, f=100Hz	V _{in}	-	OUTa	-17.5	-15.0	-12.5	dB	
			-	V _{in}	OUTb					
◆AGC										
AGC Boost1	AGC _{BST1}	Vin=100mVrms, f=1kHz AGC="10010"	V _{in}	V _{in}	OUTa	1.0	3.0	5.0	dB	
			V _{in}	V _{in}	OUTb					
AGC Boost2	AGC _{BST2}	Vin=100mVrms, f=1kHz AGC="10110"	V _{in}	V _{in}	OUTa	4.0	6.0	8.0	dB	
			V _{in}	V _{in}	OUTb					
AGC Flat1	AGC _{FLT1}	Vin=200mVrms, f=1kHz AGC="10000"	V _{in}	V _{in}	OUTa	-2.5	0.0	2.5	dB	
			V _{in}	V _{in}	OUTb					
AGC Flat2	AGC _{FLT2}	Vin=350mVrms, f=1kHz AGC="10001"	V _{in}	V _{in}	OUTa	-2.5	0.0	2.5	dB	
			V _{in}	V _{in}	OUTb					
AGC Flat3	AGC _{FLT3}	Vin=500mVrms, f=1kHz AGC="10010"	V _{in}	V _{in}	OUTa	-2.5	0.0	2.5	dB	
			V _{in}	V _{in}	OUTb					
AGC Flat4	AGC _{FLT4}	Vin=650mVrms, f=1kHz AGC="10011"	V _{in}	V _{in}	OUTa	-2.5	0.0	2.5	dB	
			V _{in}	V _{in}	OUTb					
AGC Cut	AGC _{CUT}	Vin=2Vrms, f=1kHz AGC="10000"	V _{in}	V _{in}	OUTa	-14	-10	-6.0	dB	
			V _{in}	V _{in}	OUTb					
◆SURROUND										
Surround Gain1	SR _{GAIN1}	f=100Hz, SUR1 Surround Effect1	V _{in}	-	OUTa	6.3	8.3	10.3	dB	
			-	V _{in}	OUTb					
Surround Gain2	SR _{GAIN2}	f=100Hz, SUR1 Surround Effect1	V _{in}	-	OUTb	2.1	4.1	6.1	dB	
			-	V _{in}	OUTa					
Surround Gain3	SR _{GAIN3}	f=100 Hz, SUR1 Surround Effect2	V _{in}	-	OUTa	10.7	12.7	14.7	dB	
			-	V _{in}	OUTb					
Surround Gain4	SR _{GAIN4}	f=100Hz, SUR1 Surround Effect2	V _{in}	-	OUTb	8.4	10.4	12.4	dB	
			-	V _{in}	OUTa					
Surround Gain5	SR _{GAIN5}	f=100Hz, SUR1 Surround Effect3	V _{in}	-	OUTa	14.0	16.0	18.0	dB	
			-	V _{in}	OUTb					
Simulated Stereo1	SR _{SIM1}	f=1kHz, Simulated Stereo	V _{in}	V _{in}	OUTa	1.0	3.0	5.0	dB	
Simulated Stereo2	SR _{SIM2}	f=1kHz, Simulated Stereo	V _{in}	V _{in}	OUTb	1.0	3.0	5.0	dB	

◆ VOICE ENHANCEMENT

PARAMETER	SYMBOL	Condition	Input		Output	MIN.	TYP.	MAX.	UNIT
			INa	INb					
			V _{in}	V _{in}	OUTa				
Voice Enhancement Gain 1	VE _{GAIN1}	f=5kHz, VE1 Voice Enhancement Effect 1	V _{in}	V _{in}	OUTa	3.5	6.0	8.5	dB
			V _{in}	V _{in}	OUTb				
Voice Enhancement Gain 2	VE _{GAIN2}	f=5kHz, VE2 Voice Enhancement Effect 2	V _{in}	V _{in}	OUTa	7.5	10.0	12.5	dB
			V _{in}	V _{in}	OUTb				
Voice Enhancement Gain 3	VE _{GAIN3}	f=5kHz, VE3 Voice Enhancement Effect 3	V _{in}	V _{in}	OUTa	11.5	13.0	15.5	dB
			V _{in}	V _{in}	OUTb				

◆ AUX

AUX0 Output Voltage	V _{AUX0}	Logic Output : High	-	-	-	4.5	-	5.5	V
		Logic Output : Mid				2.0	-	3.0	
		Logic Output : Low				0	-	0.5	
AUX1 Output Voltage	V _{AUX1}	Logic Output : High	-	-	-	3.5	-	V+	V
		Logic Output : Low				0	-	0.5	

■ I²C BUS BLOCK CHARACTERISTICS (SDA,SCL)

PARAMETER	SYMBOL	MIN.	TYP.	MAX.	UNIT
High Level Input Voltage	V _{IH}	3.0	-	5.0	V
Low Level Input Voltage	V _{IL}	0	-	1.5	V
High Level Input Current	I _{IH}	-	-	10	μA
Low Level Input Current	I _{IL}	-	-	10	μA
Low Level Output Voltage (3mA at SDA pin)	V _{OL}	0	-	0.4	V
Maximum Output Current	I _{OL}	-3.0	-	-	mA
Maximum Clock Frequency	f _{SCL}	-	-	100	kHz
Data Change Minimum Waiting Time	t _{BUF}	4.7	-	-	μs
Data Transfer Start Minimum Waiting Time	t _{HD:STA}	4.0	-	-	μs
Low Level Clock Pulse Width	t _{LOW}	4.7	-	-	μs
High Level Clock Pulse Width	t _{HIGH}	4.0	-	-	μs
Minimum Start Preparation Waiting Time	t _{SU:STA}	4.7	-	-	μs
Minimum Data Hold Time	t _{HD:DAT}	5.0	-	-	μs
Minimum Data Preparation Time	t _{SU:DAT}	250	-	-	ns
Rise Time	t _R	-	-	1.0	μs
Fall Time	t _F	-	-	300	ns
Minimum Stop Preparation Waiting Time	t _{SU:STO}	4.0	-	-	μs

I²C BUS Load Condition: Pull up resistance 4kΩ (Connected to +5V)
Load capacitance 200pF (Connected to GND)

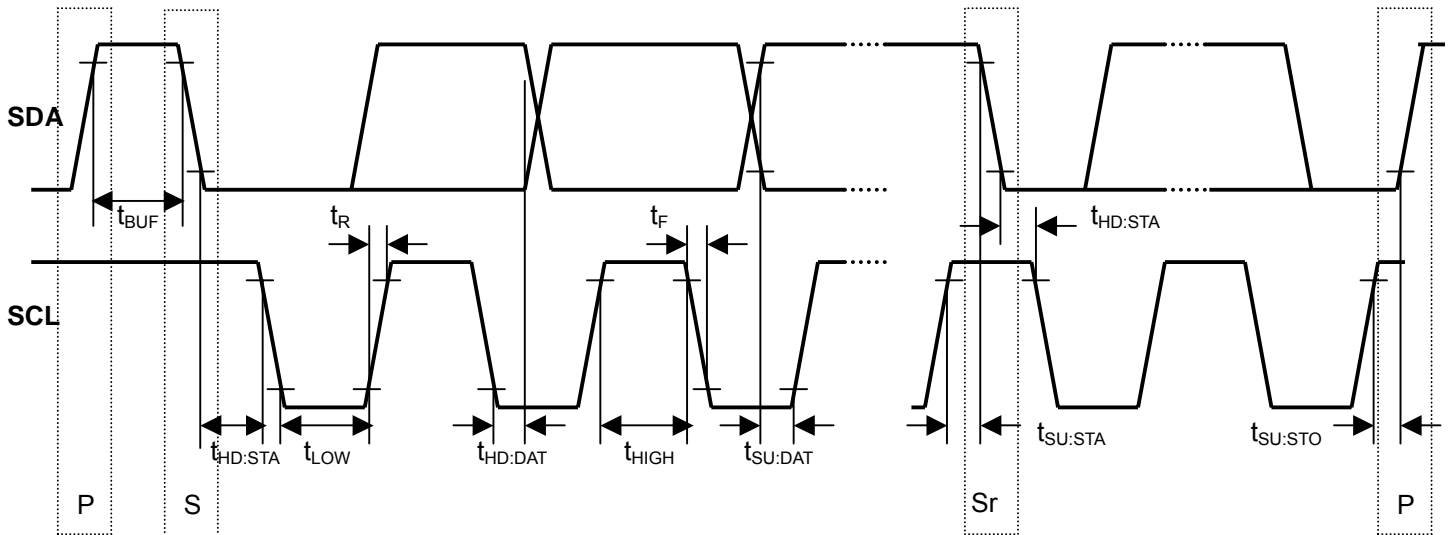

APPLICATION CIRCUIT

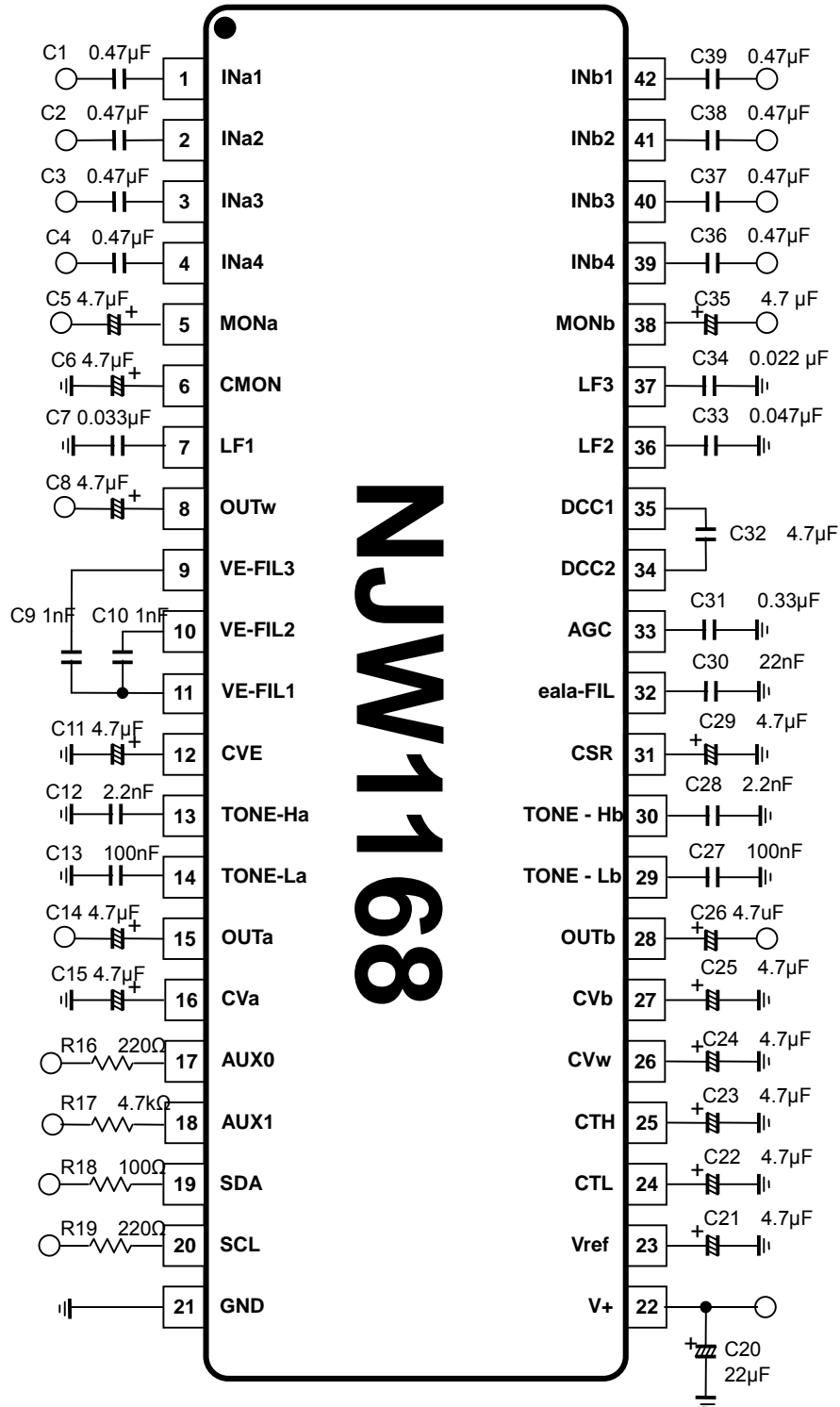

(*) Separate the I²C bus line and Signal line from the following terminals for avoiding digital noise problem and cross talk.

Pin No.	Symbol	Pin No.	Symbol	Pin No.	Symbol
7	LF1	13	TONE-Ha	32	eala-FIL
9	VE-FIL3	14	TONE-La	36	LF2
10	VE-FIL2	29	TONE-Lb	37	LF3
11	VE-FIL1	30	TONE-Hb		

■ TERMINAL DESCRIPTION

PIN NO.	SYMBOL	FUNCTION	EQUIVALENT CIRCUIT	TERMINAL VOLTAGE
1 2 3 4 42 41 40 39	INa1 INa2 INa3 INa4 INb1 INb2 INb3 INb4	Ach Input 1 Ach Input 2 Ach Input 3 Ach Input 4 Bch Input 1 Bch Input 2 Bch Input 3 Bch Input 4		V+/2
15 28 8 5 38 35	OUTa OUTb Outw MONa MONb DCC1	Ach Output Bch Output SWch Output A ch Input Selector Monitor Output B ch Input Selector Monitor Output Coupling Capacitor 1		V+/2
32	ealaFIL	eala Filter Capacitor		V+/2
13 30	TONE-Ha TONE-Hb	Ach TONE Treble Filter Capacitor Bch TONE Treble Filter Capacitor		V+/2

PIN NO.	SYMBOL	FUNCTION	EQUIVALENT CIRCUIT	TERMINAL VOLTAGE
14 29	TONE-La TONE-Lb	Ach TONE Bass Filter Capacitor Bch TONE Bass Filter Capacitor		V+/2
33	AGC	AGC Smoothing Filter Capacitor		1.4V
17	AUX0	Auxiliary Output 0		Low ; 0 V Mid ; 2.5 V High ; 5V
18	AUX1	Auxiliary Output 1		Low ; 0V High ; 3.5 V to V+

PIN NO.	SYMBOL	FUNCTION	EQUIVALENT CIRCUIT	TERMINAL VOLTAGE
19 20	SDA SCL	I ² C Data Input I ² C Clock Input		-
21 22	GND V+	Ground Power Supply	-	-
23	Vref	Reference Voltage stabilizing Capacitor		V+/2
31 12	CSR CVE	eala switching noise rejection Capacitor VE switching noise rejection Capacitor		0V

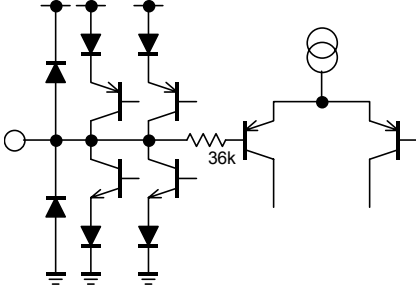
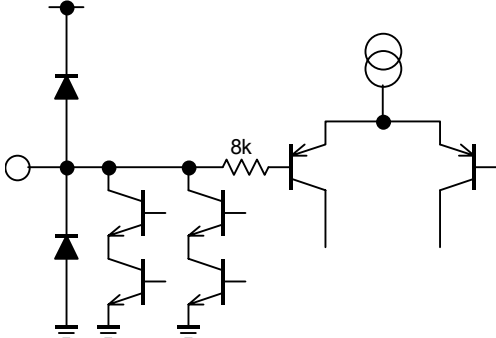
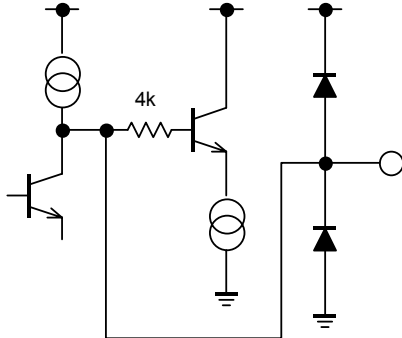
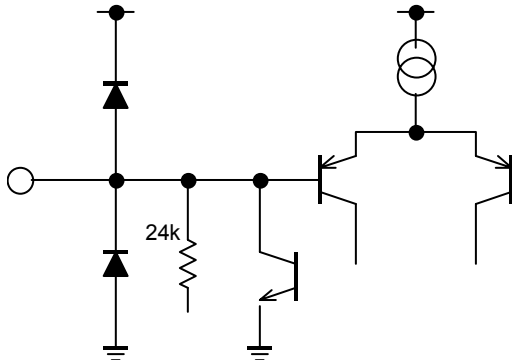
PIN NO.	SYMBOL	FUNCTION	EQUIVALENT CIRCUIT	TERMINAL VOLTAGE
25 24	CTH CTL	Tone Control Treble switching noise rejection Capacitor Tone Control Bass switching noise rejection Capacitor		V+/2
16 27 26	CVa CVb CVw	Ach Volume switching noise rejection Capacitor Bch Volume switching noise rejection Capacitor SWch Trimmer switching noise rejection Capacitor		V+/2
36 37	LF2 LF3	Low Pass Filter Capacitor 2 Low Pass Filter Capacitor 3		V+/2+0.7V
7	LF1	Low Pass Filter Capacitor 1		V+/2

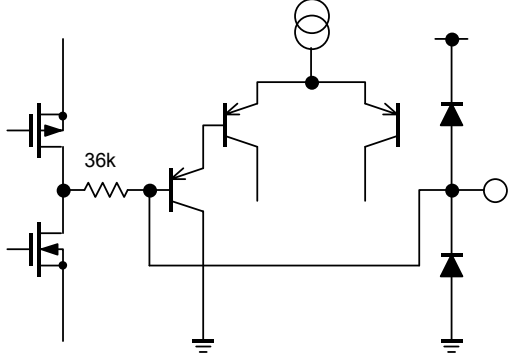
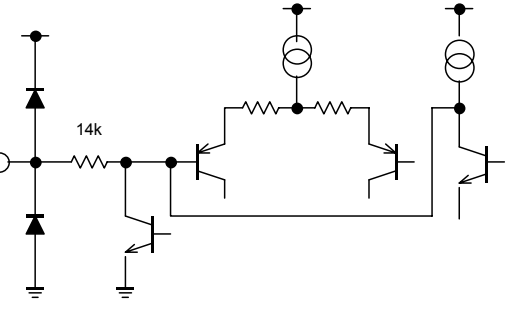
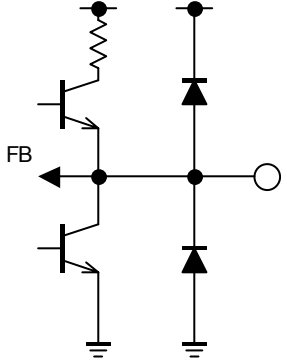
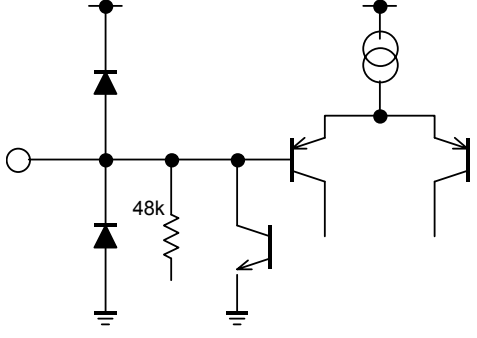
PIN NO.	SYMBOL	FUNCTION	EQUIVALENT CIRCUIT	TERMINAL VOLTAGE
6	CMON	MONa/b switching noise rejection Capacitor		0V, 5V
34	DCC2	Coupling Capacitor 2		V+/2
9	VE-FIL3	Voice Enhancement Filter Capacitor 3		V+/2
10	VE-FIL2	Voice Enhancement Filter Capacitor 2		V+/2

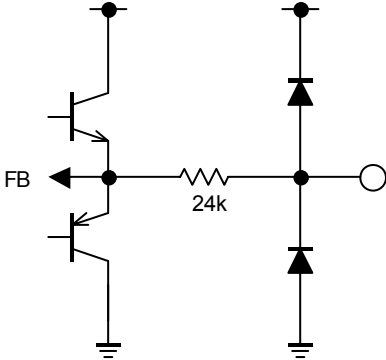
PIN NO.	SYMBOL	FUNCTION	EQUIVALENT CIRCUIT	TERMINAL VOLTAGE
11	VE-FIL1	Voice Enhancement Filter Capacitor 1	 <p>The diagram shows an equivalent circuit for the VE-FIL1 pin. On the left, two transistors are connected in a feedback loop. The top transistor's collector is connected to its base, and the bottom transistor's collector is connected to its base. A 24k resistor is connected between the base of the top transistor and the base of the bottom transistor. The base of the top transistor is labeled 'FB'. The output of the circuit is taken from a node connected to the collector of the top transistor, the collector of the bottom transistor, and a diode network. The diode network consists of two diodes connected in series to ground, with a terminal connected to the node between the two diodes.</p>	V+/2

LPF Characteristics

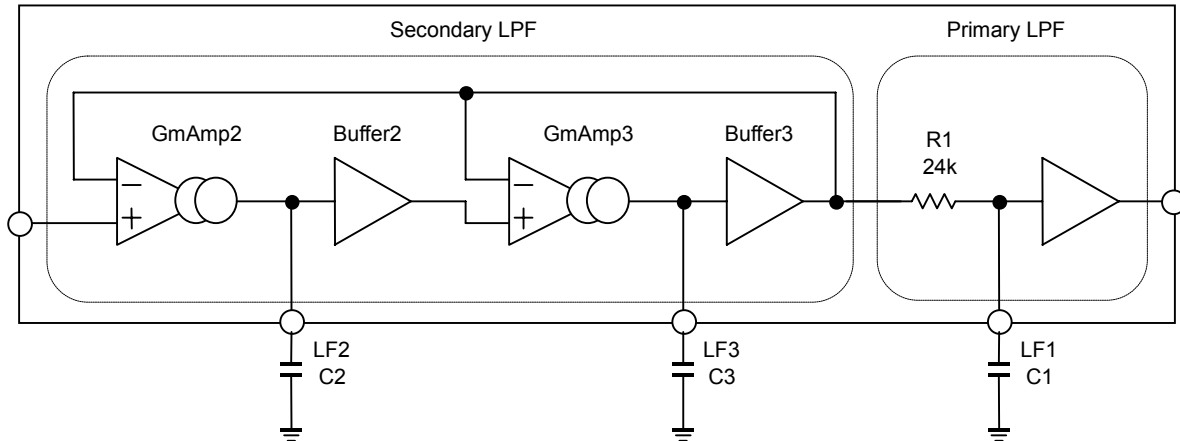

The NJW1168 includes the LPF for subwoofer output and bass boost function. The LPF consists of primary and secondary LPF and it is enable to adjust “cut off frequency”, “Q” and “Roll off”. The expression of LPF characteristics is as follows.

<Primary LPF>

$$f_{c1} = \frac{1}{2\pi * R * C1} = \frac{1}{2\pi * 24 * 10^3 * C1} \quad Q_1 = 0.5$$

<Secondary LPF>

$$f_{c2} = \frac{42.9 * 10^{-6}}{2\pi * \sqrt{C2 * C3}} \quad Q_2 = 1.46 * \sqrt{\frac{C3}{C2}}$$

<LPF Frequency Response>

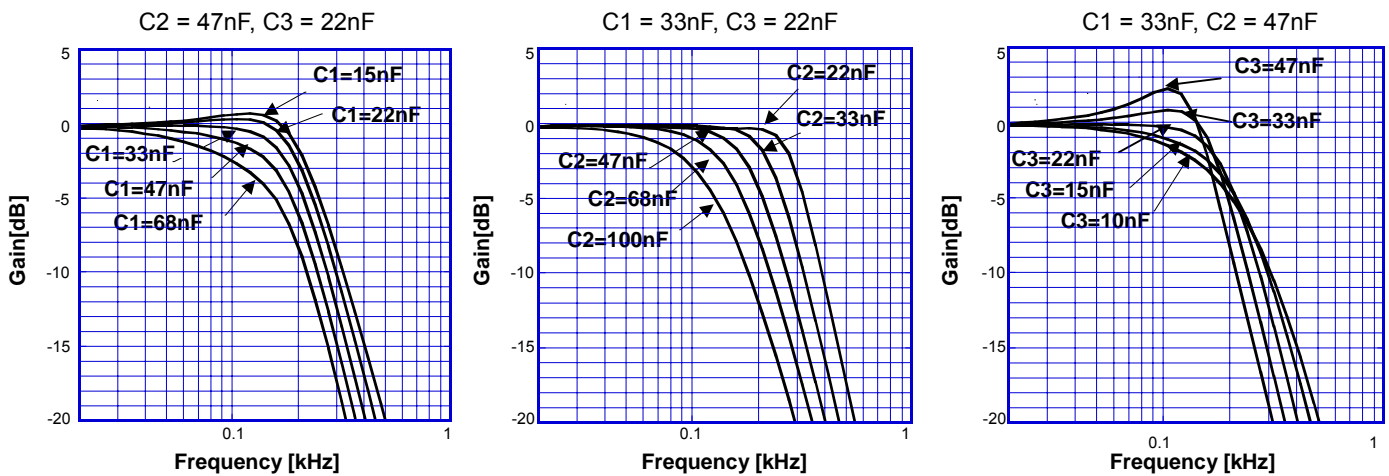

■ DEFINITION OF I²C REGISTER

◆ I²C BUS FORMAT

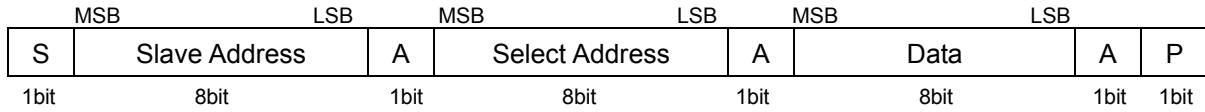

S: Starting Term
 A: Acknowledge Bit
 P: Ending Term

◆ SLAVE ADDRESS

Slave Address								Hex
MSB							LSB	-
1	0	0	0	0	0	0	0	80(h)

◆ CONTROL REGISTER TABLE

The select address sets each function (Volume, Balance, Trimmer, Bass Boost Select, Tone Control, Surround, AGC, Voice Enhancement, Input Selector, Monitor Out, AUX).

The auto increment function cycles the select address as follows.

00H→01H→02H→03H→04H→05H→06H→00H

<Write Mode>

Select Address	BIT							
	D7	D6	D5	D4	D3	D2	D1	D0
00H	VOL							
01H	CHS	BAL						*
02H	TRIM						BBSW	
03H	BCB	BASS				*		
04H	BCT	TREB				*		
05H	SUR			AGC				
06H	VE		MOSW	AUX1	AUX0		SEL	

* : Don't Care

◆ CONTROL REGISTER DEFAULT VALUE

Control register default value is all "0".

Select Address	BIT							
	D7	D6	D5	D4	D3	D2	D1	D0
00H	0	0	0	0	0	0	0	0
01H	0	0	0	0	0	0	0	0
02H	0	0	0	0	0	0	0	0
03H	0	0	0	0	0	0	0	0
04H	0	0	0	0	0	0	0	0
05H	0	0	0	0	0	0	0	0
06H	0	0	0	0	0	0	0	0

■ INSTRUCTION CODE

a) MASTER VOLUME SETTING

Select Address	BIT							
	D7	D6	D5	D4	D3	D2	D1	D0
00H	VOL							

- VOL Attenuation level : 0 to -80dB(0.33dB/step) , MUTE
 The attenuator is consisted of both the VOL1(0.165dB/step)and VOL2(0.165dB/step) and is enable to adjust 0.33dB/step. The attenuation for both the VOL1and VOL2 are always synchronized to have the same attenuation levels for each other, and are not controllable independently for each other.
- ex) VOL(-30dB) = VOL1(-15dB) + VOL2(-15dB)

b) BALANCE SETTING

Select Address	BIT								
	D7	D6	D5	D4	D3	D2	D1	D0	
01H	CHS	BAL						Don't Care	

- CHS : Channel select for balance control
 "0" : Ach "Bch is attenuated"
 "1" : Bch "Ach is attenuated"
- BAL : Balance control for both Ach and Bch
 Balance Level : 0 to -60dB (0.5dB/Step) , MUTE

c) TRIMMER LEVEL AND BASS BOOST FUNCTION SETTING

Select Address	BIT							
	D7	D6	D5	D4	D3	D2	D1	D0
02H	TRIM							BBSW

- TRIM : Trimmer Level
 Trimmer Level : +30 to -6dB (0.5dB/Step) , MUTE
- BBSW : Bass Boost ON/OFF Switch
 "0" = Bass Boost OFF
 "1" = Bass Boost ON

d) TONE CONTROL BASS SETTING

Select Address	BIT								
	D7	D6	D5	D4	D3	D2	D1	D0	
03H	BCB	BASS					Don't Care		

- BCB : Boost cut select for Bass control
 "0" : Cut
 "1" : Boost
- BASS : BASS Level Setting
 Cut Level : -15 to 0dB(0.5dB/Step)
 Boost Level : 0 to +15dB(0.5dB/Step)

e) TONE CONTROL TREBLE SETTING

Select Address	BIT								
	D7	D6	D5	D4	D3	D2	D1	D0	
04H	BCT	TREB					Don't Care		

- BCT : Boost cut select for Treble control
 "0" : Cut
 "1" : Boost
- TREB : TREBLE Level Setting
 Cut Level : -15 to 0dB(0.5dB/Step)
 Boost Level : 0 to +15dB(0.5dB/Step)

f) Surround, AGC LEVEL SETTING

Select Address	BIT							
	D7	D6	D5	D4	D3	D2	D1	D0
05H	SUR				AGC			

<SUR : Surround Level Setting>

Surround Setting	D7	D6	D5	Remarks
Bypass	0	0	0	Bypass
Simulated Stereo	0	0	1	Simulated Stereo
eala Effect1	0	1	0	Surround Effect Low(8.3dB typ.)
eala Effect2	0	1	1	Surround Effect Mid(12.7dB typ.)
eala Effect3	1	0	0	Surround Effect High(16dB typ.)

<AGC : AGC Setting>

●AGC ON/OFF

AGC	D4
OFF	0
ON	1

●AGCBST1 : AGC Boost Start Point

AGCBST1	D3
Low (20mVrms Input)	0
High (100mVrms Input)	1

●AGCBST2 : AGC Boost Gain

AGCBST2	D2
Low (3dB)	0
High (6dB)	1

●AGCFLT : AGC Flat Level

AGCFLT	D1	D0
200mV	0	0
350mV	0	1
500mV	1	0
650mV	1	1

g) Input Selector, Monitor Out Switch, AUXILIARY SETTING

Select Address	BIT							
	D7	D6	D5	D4	D3	D2	D1	D0
05H	VE		MOSW	AUX1	AUX0		SEL	

<VE : Voice Enhancement Setting>

VE Setting	D7	D6	Remarks
By-Pass	0	0	Bypass
VE Effect 1	0	1	Voice Enhancement Effect Low(9dB typ.)
VE Effect 2	1	0	Voice Enhancement Effect Mid(10dB typ.)
VE Effect 3	1	1	Voice Enhancement Effect High(13dB typ.)

<MOSW : Monitor Output Setting>

MOSW Setting	D5
Signal Output	0
Mute	1

<AUX1 : AUX1 Terminal Setting>

Auxiliary Setting	D4
Low (0.0V)	0
High (5.0V)	1

<AUX0 : AUX0 Terminal Setting>

Auxiliary Setting	D3	D2
Low (0.0V)	-	0
Mid (2.5V)	0	1
High (5.0V)	1	1

<SEL : Input Selector Setting>

SEL Setting	D1	D0
Input 1	0	0
Input 2	0	1
Input 3	1	0
Input 4	1	1

■Master Volume (Select Address : 00H)

		VOL							
		D7	D6	D5	D4	D3	D2	D1	D0
Gain(dB)	HEX								
0	FF	1	1	1	1	1	1	1	1
-1	FC	1	1	1	1	1	1	0	0
-2	F9	1	1	1	1	1	0	0	1
-3	F6	1	1	1	1	0	1	1	0
-4	F3	1	1	1	1	0	0	1	1
-5	F0	1	1	1	1	0	0	0	0
-6	ED	1	1	1	0	1	1	0	1
-7	EA	1	1	1	0	1	0	1	0
-8	E7	1	1	1	0	0	1	1	1
-9	E4	1	1	1	0	0	1	0	0
-10	E1	1	1	1	0	0	0	0	1
-11	DE	1	1	0	1	1	1	1	0
-12	DB	1	1	0	1	1	0	1	1
-13	D8	1	1	0	1	1	0	0	0
-14	D5	1	1	0	1	0	1	0	1
-15	D2	1	1	0	1	0	0	1	0
-16	CF	1	1	0	0	1	1	1	1
-17	CC	1	1	0	0	1	1	0	0
-18	C9	1	1	0	0	1	0	0	1
-19	C6	1	1	0	0	0	1	1	0
-20	C3	1	1	0	0	0	0	1	1
-21	C0	1	1	0	0	0	0	0	0
-22	BD	1	0	1	1	1	1	0	1
-23	BA	1	0	1	1	1	0	1	0
-24	B7	1	0	1	1	0	1	1	1
-25	B4	1	0	1	1	0	1	0	0
-26	B1	1	0	1	1	0	0	0	1
-27	AE	1	0	1	0	1	1	1	0
-28	AB	1	0	1	0	1	0	1	1
-29	A8	1	0	1	0	1	0	0	0
-30	A5	1	0	1	0	0	1	0	1
-31	A2	1	0	1	0	0	0	1	0
-32	9F	1	0	0	1	1	1	1	1
-33	9C	1	0	0	1	1	1	0	0
-34	99	1	0	0	1	1	0	0	1
-35	96	1	0	0	1	0	1	1	0
-36	93	1	0	0	1	0	0	1	1
-37	90	1	0	0	1	0	0	0	0
-38	8D	1	0	0	0	1	1	0	1
-39	8A	1	0	0	0	1	0	1	0
-40	87	1	0	0	0	0	1	1	1
-41	84	1	0	0	0	0	1	0	0
-42	81	1	0	0	0	0	0	0	1

		VOL							
Gain(dB)	HEX	D7	D6	D5	D4	D3	D2	D1	D0
-43	7E	0	1	1	1	1	1	1	0
-44	7B	0	1	1	1	1	0	1	1
-45	78	0	1	1	1	1	0	0	0
-46	75	0	1	1	1	0	1	0	1
-47	72	0	1	1	1	0	0	1	0
-48	6F	0	1	1	0	1	1	1	1
-49	6C	0	1	1	0	1	1	0	0
-50	69	0	1	1	0	1	0	0	1
-51	66	0	1	1	0	0	1	1	0
-52	63	0	1	1	0	0	0	1	1
-53	60	0	1	1	0	0	0	0	0
-54	5D	0	1	0	1	1	1	0	1
-55	5A	0	1	0	1	1	0	1	0
-56	57	0	1	0	1	0	1	1	1
-57	54	0	1	0	1	0	1	0	0
-58	51	0	1	0	1	0	0	0	1
-59	4E	0	1	0	0	1	1	1	0
-60	4B	0	1	0	0	1	0	1	1
-61	48	0	1	0	0	1	0	0	0
-62	45	0	1	0	0	0	1	0	1
-63	42	0	1	0	0	0	0	1	0
-64	3F	0	0	1	1	1	1	1	1
-65	3C	0	0	1	1	1	1	0	0
-66	39	0	0	1	1	1	0	0	1
-67	36	0	0	1	1	0	1	1	0
-68	33	0	0	1	1	0	0	1	1
-69	30	0	0	1	1	0	0	0	0
-70	2D	0	0	1	0	1	1	0	1
-71	2A	0	0	1	0	1	0	1	0
-72	27	0	0	1	0	0	1	1	1
-73	24	0	0	1	0	0	1	0	0
-74	21	0	0	1	0	0	0	0	1
-75	1E	0	0	0	1	1	1	1	0
-76	1B	0	0	0	1	1	0	1	1
-77	18	0	0	0	1	1	0	0	0
-78	15	0	0	0	1	0	1	0	1
-79	12	0	0	0	1	0	0	1	0
-80	0F	0	0	0	0	1	1	1	1
MUTE*	00	0	0	0	0	0	0	0	0

* : Default Value

■Balance Setting (Select Address : 01H)

Channel Setting (CHS)	D7
Decrease Bch Gain	0
Decrease Ach Gain	1

Gain(dB)	BAL					
	D6	D5	D4	D3	D2	D1
0*	0	0	0	0	0	0
-1	0	0	0	0	0	1
-2	0	0	0	0	1	0
-3	0	0	0	0	1	1
-4	0	0	0	1	0	0
-5	0	0	0	1	0	1
-6	0	0	0	1	1	0
-7	0	0	0	1	1	1
-8	0	0	1	0	0	0
-9	0	0	1	0	0	1
-10	0	0	1	0	1	0
-11	0	0	1	0	1	1
-12	0	0	1	1	0	0
-13	0	0	1	1	0	1
-14	0	0	1	1	1	0
-15	0	0	1	1	1	1
-16	0	1	0	0	0	0
-17	0	1	0	0	0	1
-18	0	1	0	0	1	0
-19	0	1	0	0	1	1
-20	0	1	0	1	0	0
-21	0	1	0	1	0	1
-22	0	1	0	1	1	0
-23	0	1	0	1	1	1
-24	0	1	1	0	0	0
-25	0	1	1	0	0	1
-26	0	1	1	0	1	0
-27	0	1	1	0	1	1
-28	0	1	1	1	0	0
-29	0	1	1	1	0	1
-30	0	1	1	1	1	0

* : Default Value

Gain(dB)	BAL					
	D6	D5	D4	D3	D2	D1
-31	0	1	1	1	1	1
-32	1	0	0	0	0	0
-33	1	0	0	0	0	1
-34	1	0	0	0	1	0
-35	1	0	0	0	1	1
-36	1	0	0	1	0	0
-37	1	0	0	1	0	1
-38	1	0	0	1	1	0
-39	1	0	0	1	1	1
-40	1	0	1	0	0	0
-41	1	0	1	0	0	1
-42	1	0	1	0	1	0
-43	1	0	1	0	1	1
-44	1	0	1	1	0	0
-45	1	0	1	1	0	1
-46	1	0	1	1	1	0
-47	1	0	1	1	1	1
-48	1	1	0	0	0	0
-49	1	1	0	0	0	1
-50	1	1	0	0	1	0
-51	1	1	0	0	1	1
-52	1	1	0	1	0	0
-53	1	1	0	1	0	1
-54	1	1	0	1	1	0
-55	1	1	0	1	1	1
-56	1	1	1	0	0	0
-57	1	1	1	0	0	1
-58	1	1	1	0	1	0
-59	1	1	1	0	1	1
-60	1	1	1	1	0	0
MUTE	1	1	1	1	1	1

■Trimmer Setting (Select Address: 02H)

Gain(dB)	TRIM						
	D7	D6	D5	D4	D3	D2	D1
+30.0	1	1	1	1	1	1	1
+29.5	1	1	1	1	1	1	0
+29.0	1	1	1	1	1	0	1
+28.5	1	1	1	1	1	0	0
+28.0	1	1	1	1	0	1	1
+27.5	1	1	1	1	0	1	0
+27.0	1	1	1	1	0	0	1
+26.5	1	1	1	1	0	0	0
+26.0	1	1	1	0	1	1	1
+25.5	1	1	1	0	1	1	0
+25.0	1	1	1	0	1	0	1
+24.5	1	1	1	0	1	0	0
+24.0	1	1	1	0	0	1	1
+23.5	1	1	1	0	0	1	0
+23.0	1	1	1	0	0	0	1
+22.5	1	1	1	0	0	0	0
+22.0	1	1	0	1	1	1	1
+21.5	1	1	0	1	1	1	0
+21.0	1	1	0	1	1	0	1
+20.5	1	1	0	1	1	0	0
+20.0	1	1	0	1	0	1	1
+19.5	1	1	0	1	0	1	0
+19.0	1	1	0	1	0	0	1
+18.5	1	1	0	1	0	0	0
+18.0	1	1	0	0	1	1	1
+17.5	1	1	0	0	1	1	0
+17.0	1	1	0	0	1	0	1
+16.5	1	1	0	0	1	0	0
+16.0	1	1	0	0	0	1	1
+15.5	1	1	0	0	0	1	0
+15.0	1	1	0	0	0	0	1
+14.5	1	1	0	0	0	0	0
+14.0	1	0	1	1	1	1	1
+13.5	1	0	1	1	1	1	0
+13.0	1	0	1	1	1	0	1
+12.5	1	0	1	1	1	0	0
+12.0	1	0	1	1	0	1	1
+11.5	1	0	1	1	0	1	0
+11.0	1	0	1	1	0	0	1
+10.5	1	0	1	1	0	0	0
+10.0	1	0	1	0	1	1	1
+9.5	1	0	1	0	1	1	0
+9.0	1	0	1	0	1	0	1
+8.5	1	0	1	0	1	0	0
+8.0	1	0	1	0	0	1	1
+7.5	1	0	1	0	0	1	0
+7.0	1	0	1	0	0	0	1
+6.5	1	0	1	0	0	0	0
+6.0	1	0	0	1	1	1	1

Gain(dB)	TRIM						
	D7	D6	D5	D4	D3	D2	D1
+5.5	1	0	0	1	1	1	0
+5.0	1	0	0	1	1	0	1
+4.5	1	0	0	1	1	0	0
+4.0	1	0	0	1	0	1	1
+3.5	1	0	0	1	0	1	0
+3.0	1	0	0	1	0	0	1
+2.5	1	0	0	1	0	0	0
+2.0	1	0	0	0	1	1	1
+1.5	1	0	0	0	1	1	0
+1.0	1	0	0	0	1	0	1
+0.5	1	0	0	0	1	0	0
0.0	1	0	0	0	0	1	1
-0.5	1	0	0	0	0	1	0
-1.0	1	0	0	0	0	0	1
-1.5	1	0	0	0	0	0	0
-2.0	0	1	1	1	1	1	1
-2.5	0	1	1	1	1	1	0
-3.0	0	1	1	1	1	0	1
-3.5	0	1	1	1	1	0	0
-4.0	0	1	1	1	0	1	1
-4.5	0	1	1	1	0	1	0
-5.0	0	1	1	1	0	0	1
-5.5	0	1	1	1	0	0	0
-6.0	0	1	1	0	1	1	1
MUTE*	0	0	0	0	0	0	0

* : Default value

■ Bass Boost Setting (Select Address: 02H)

Bass Boost Setting (BBSW)	D0
Bass Boost Off*	0
Bass Boost On	1

* : Default Value

■Tone Control(Bass Setting) (Select Address : 03H)

Bass Cut or Boost	BCB
	D7
Cut	0
Boost	1

Cut Gain(dB) / Boost Gain(dB)		BASS				
Cut Gain(dB)	Boost Gain(dB)	D6	D5	D4	D3	D2
-15.0	15.0	1	1	1	1	0
-14.5	14.5	1	1	1	0	1
-14.0	14.0	1	1	1	0	0
-13.5	13.5	1	1	0	1	1
-13.0	13.0	1	1	0	1	0
-12.5	12.5	1	1	0	0	1
-12.0	12.0	1	1	0	0	0
-11.5	11.5	1	0	1	1	1
-11.0	11.0	1	0	1	1	0
-10.5	10.5	1	0	1	0	1
-10.0	10.0	1	0	1	0	0
-9.5	9.5	1	0	0	1	1
-9.0	9.0	1	0	0	1	0
-8.5	8.5	1	0	0	0	1
-8.0	8.0	1	0	0	0	0
-7.5	7.5	0	1	1	1	1
-7.0	7.0	0	1	1	1	0
-6.5	6.5	0	1	1	0	1
-6.0	6.0	0	1	1	0	0
-5.5	5.5	0	1	0	1	1
-5.0	5.0	0	1	0	1	0
-4.5	4.5	0	1	0	0	1
-4.0	4.0	0	1	0	0	0
-3.5	3.5	0	0	1	1	1
-3.0	3.0	0	0	1	1	0
-2.5	2.5	0	0	1	0	1
-2.0	2.0	0	0	1	0	0
-1.5	1.5	0	0	0	1	1
-1.0	1.0	0	0	0	1	0
-0.5	0.5	0	0	0	0	1
0.0*	0.0*	0	0	0	0	0

* : Default value

■Tone Control(Treble Setting) (Select Address : 04H)

Treble Cut or Boost	BCT
	D7
Cut	0
Boost	1

		TREB				
Cut Gain(dB)	Boost Gain(dB)	D6	D5	D4	D3	D2
-15.0	15.0	1	1	1	1	0
-14.5	14.5	1	1	1	0	1
-14.0	14.0	1	1	1	0	0
-13.5	13.5	1	1	0	1	1
-13.0	13.0	1	1	0	1	0
-12.5	12.5	1	1	0	0	1
-12.0	12.0	1	1	0	0	0
-11.5	11.5	1	0	1	1	1
-11.0	11.0	1	0	1	1	0
-10.5	10.5	1	0	1	0	1
-10.0	10.0	1	0	1	0	0
-9.5	9.5	1	0	0	1	1
-9.0	9.0	1	0	0	1	0
-8.5	8.5	1	0	0	0	1
-8.0	8.0	1	0	0	0	0
-7.5	7.5	0	1	1	1	1
-7.0	7.0	0	1	1	1	0
-6.5	6.5	0	1	1	0	1
-6.0	6.0	0	1	1	0	0
-5.5	5.5	0	1	0	1	1
-5.0	5.0	0	1	0	1	0
-4.5	4.5	0	1	0	0	1
-4.0	4.0	0	1	0	0	0
-3.5	3.5	0	0	1	1	1
-3.0	3.0	0	0	1	1	0
-2.5	2.5	0	0	1	0	1
-2.0	2.0	0	0	1	0	0
-1.5	1.5	0	0	0	1	1
-1.0	1.0	0	0	0	1	0
-0.5	0.5	0	0	0	0	1
0.0*	0.0*	0	0	0	0	0

* : Default value

■ TYPICAL CHARACTERISTICS

fig.1 Supply Current vs Supply Voltage

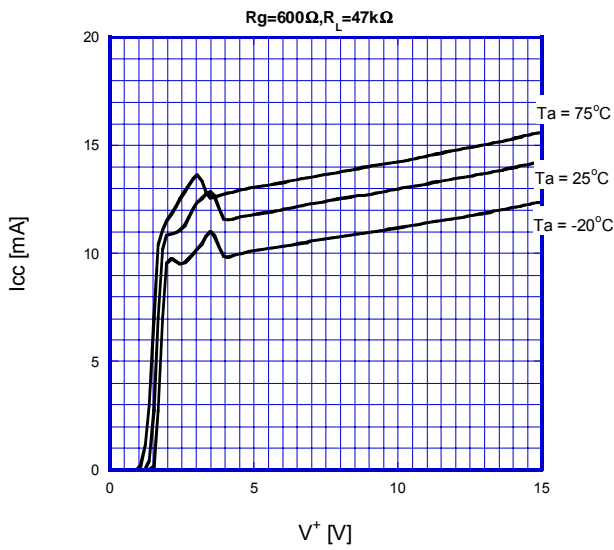

fig.2 Supply Current vs Temperature

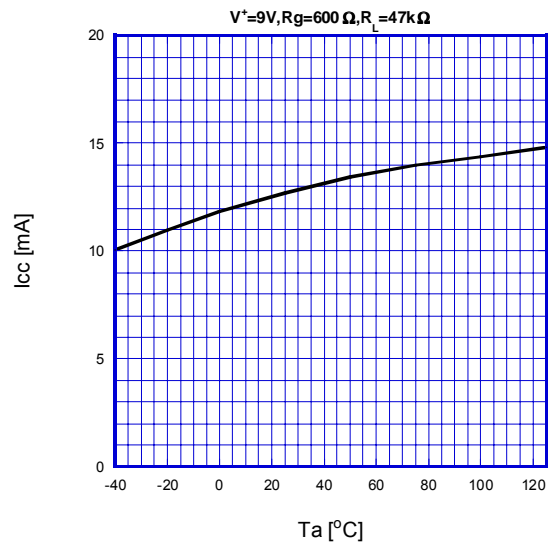

fig.3 Reference Voltage vs Supply Voltage

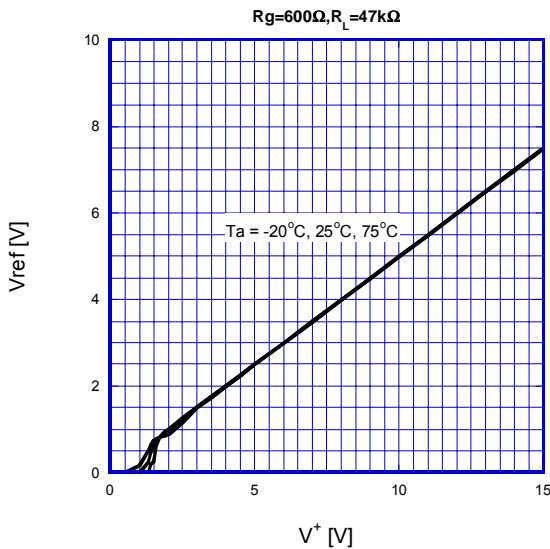

fig.4 Reference Voltage vs Temperature

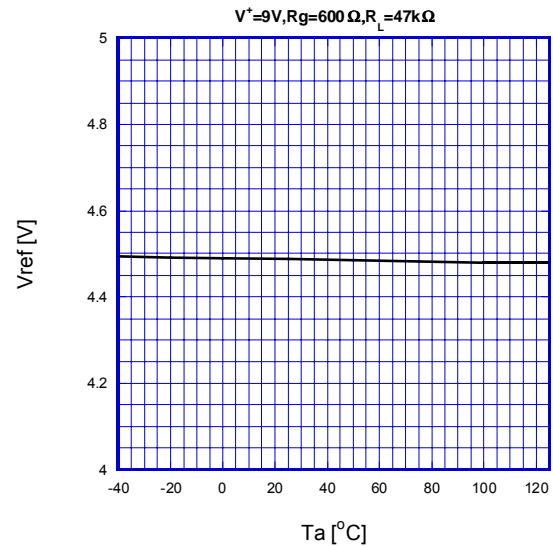

fig.5 Voltage Gain vs Volume Control

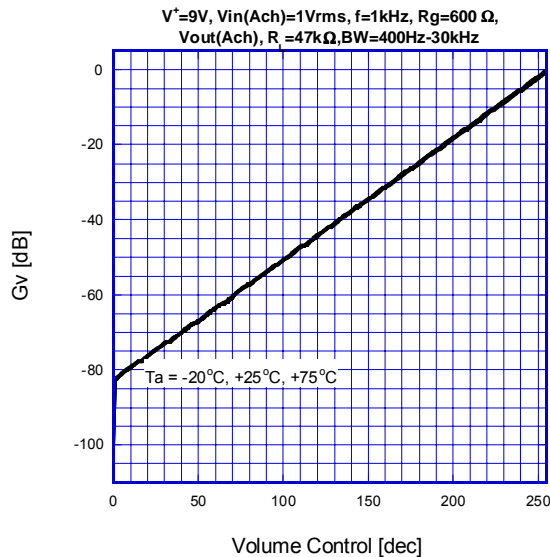
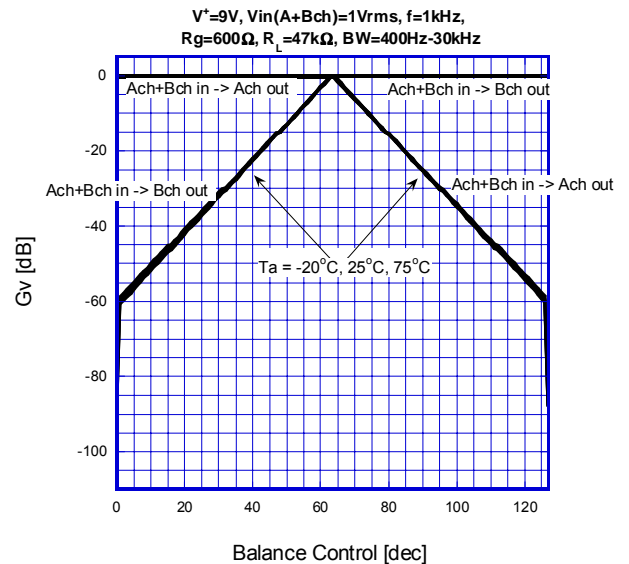

fig.6 Voltage Gain vs Balance Control



■ TYPICAL CHARACTERISTICS

fig.7 Voltage Gain vs Trimmer Control

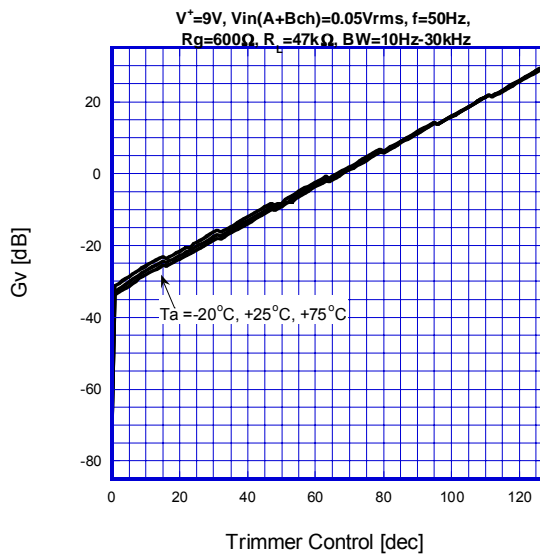

fig.9 THD+N vs Input Voltage (Wch)

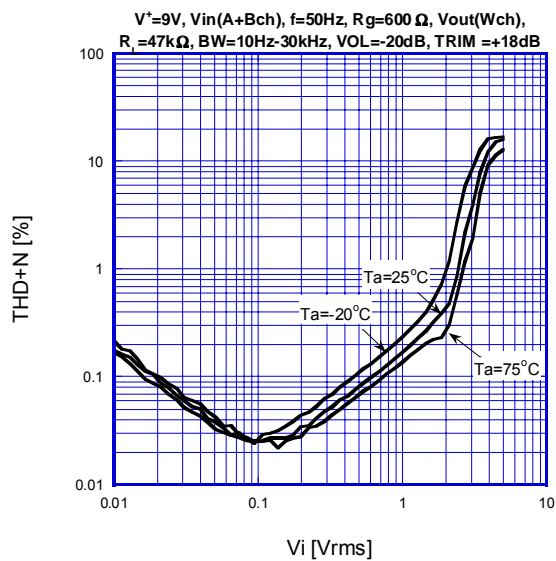

fig.11 THD+N vs Input Voltage (Wch)

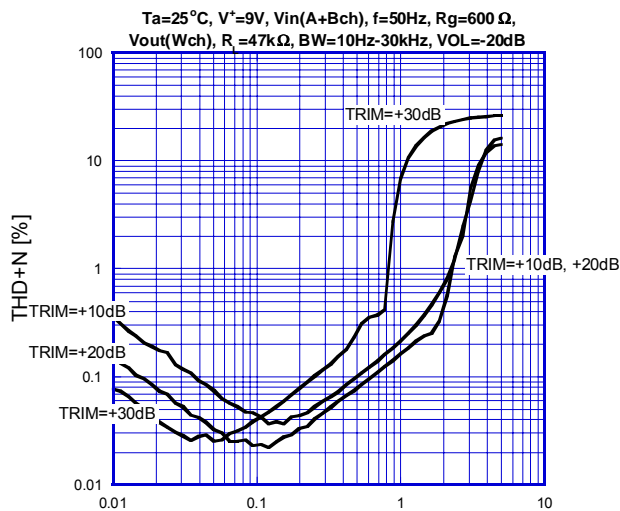

fig.8 THD+N vs Input Voltage(Ach,Bch)

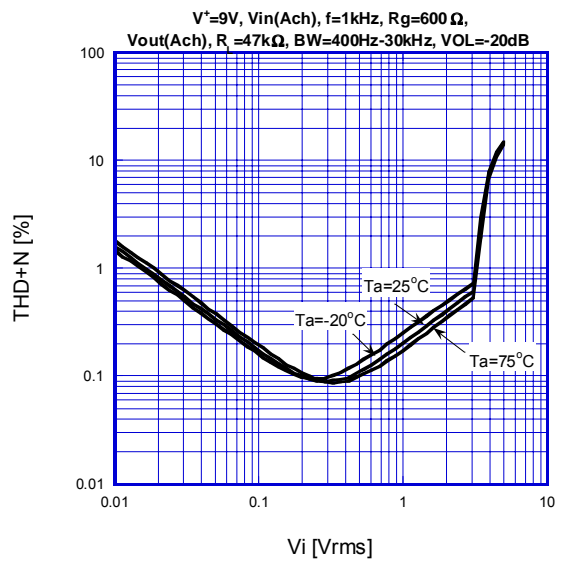

fig.10 THD+N vs Input Voltage (Ach, Bch)

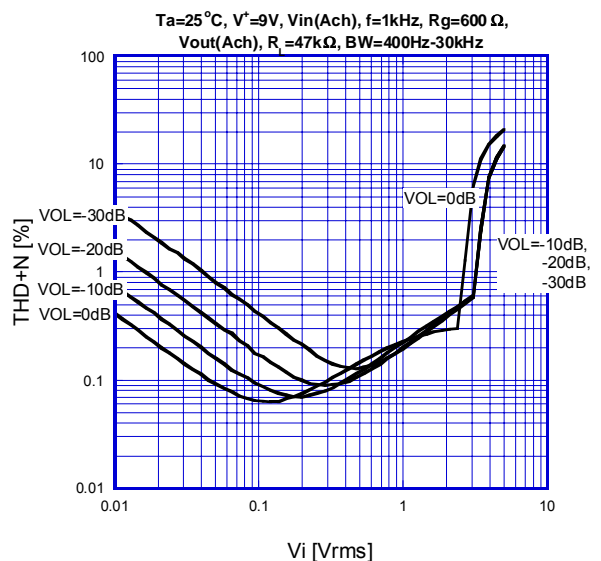
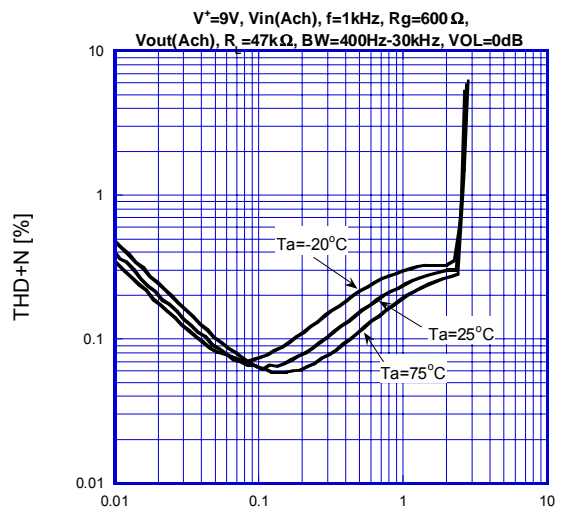

fig.12 THD+N vs Output Voltage (Ach, Bch)



■ TYPICAL CHARACTERISTICS

fig.13 THD+N vs OutPut Voltage (Wch)

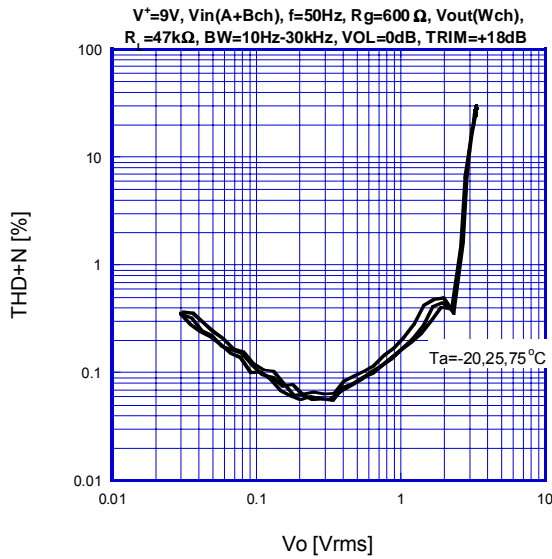

fig.15 Maximum Input Voltage vs Temperature

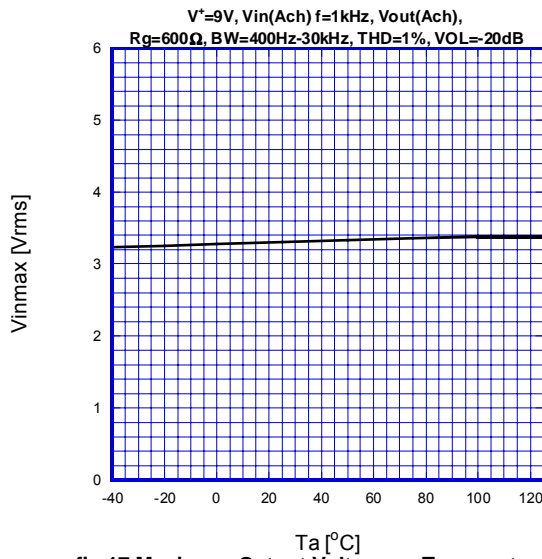

fig.17 Maximum Output Voltage vs Temperature

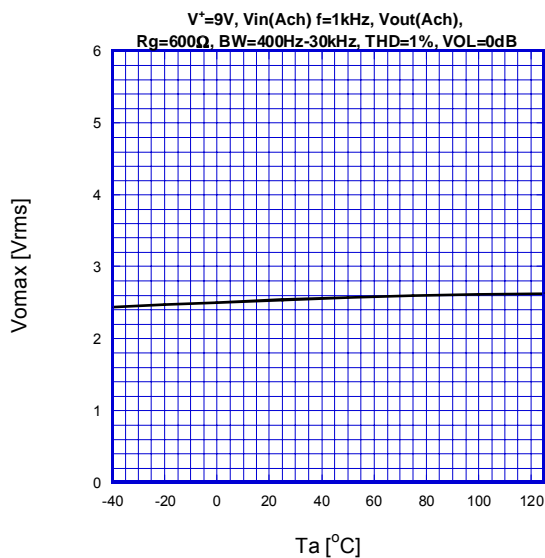

fig.14 Maximum Input Voltage vs Supply Voltage

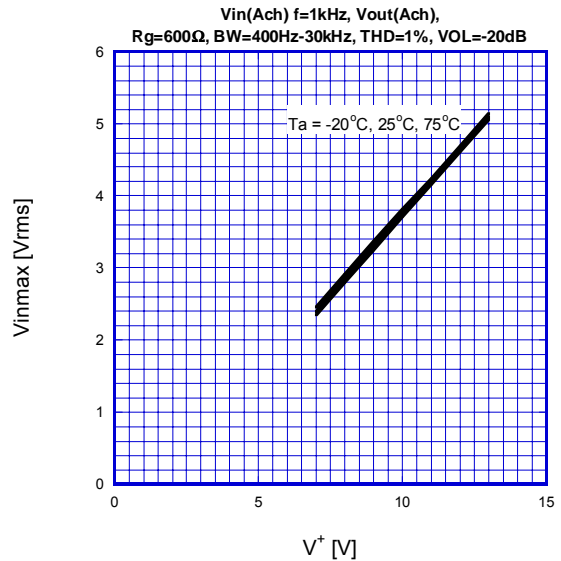

fig.16 Maximum Output Voltage vs Supply Voltage

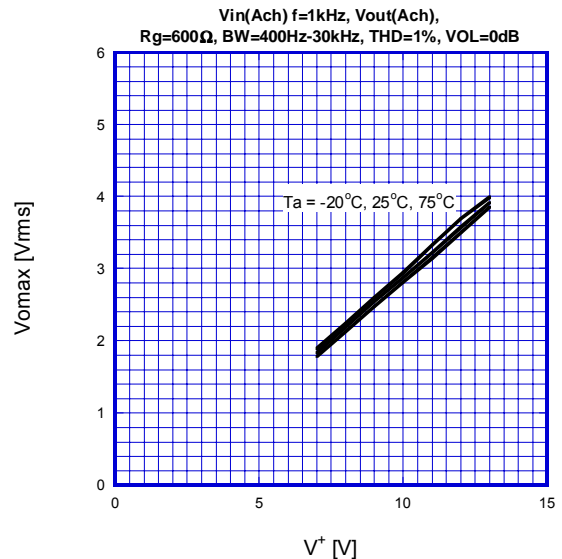
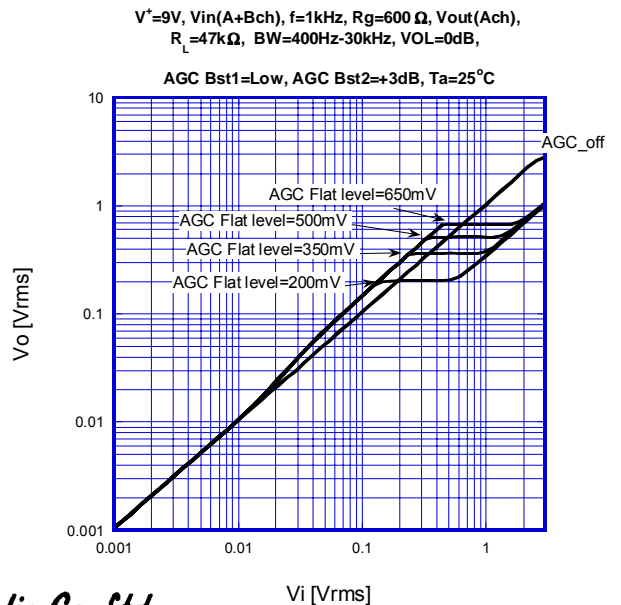

fig.18 AGC Characteristics (Flat level)



■ TYPICAL CHARACTERISTICS

fig.19 AGC Characteristics (Bst1)

$V^+=9V$, $V_{in}(A+Bch)$, $f=1kHz$, $R_g=600\Omega$, $V_{out}(Ach)$, $R_L=47k\Omega$, $BW=400Hz-30kHz$, $VOL=0dB$,

AGC Flat=500mV, AGC Bst2=+3dB, $T_a=25^\circ C$

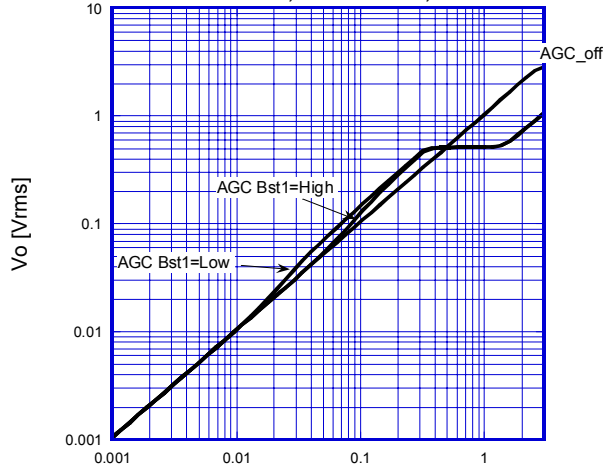

fig.21 AGC Characteristics (Ta)

$V^+=9V$, $V_{in}(A+Bch)$, $f=1kHz$, $R_g=600\Omega$, $V_{out}(Ach)$, $R_L=47k\Omega$, $BW=400Hz-30kHz$, $VOL=0dB$, AGC Flat=500mV, AGC Bst1=Low, AGC Bst2=+3dB

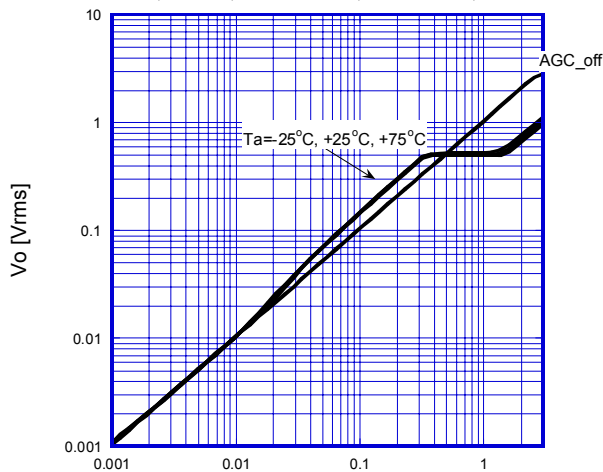

fig.23 AGC Characteristics (Recovery)

$V^+=9V$, $V_{in}(A+Bch)=1Vrms$, $f=10kHz$, $R_g=600\Omega$, $V_{out}(Ach)$, $R_L=47k\Omega$, $VOL=0dB$, $R_{EXT}=100k\Omega$, $C_{EXT}=330nF$, AGC level=200mV, $T_a=25^\circ C$

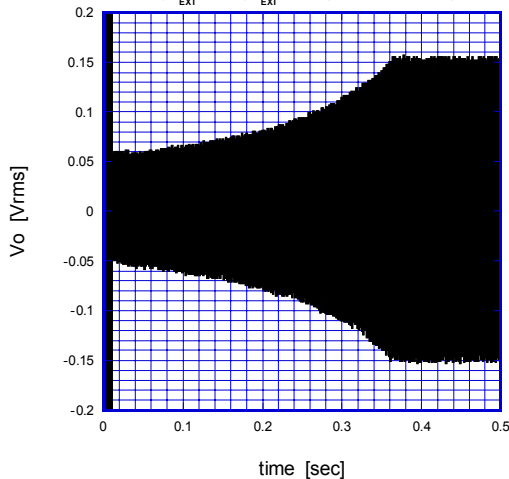

fig.20 AGC Characteristics (Bst2)

$V^+=9V$, $V_{in}(A+Bch)$, $f=1kHz$, $R_g=600\Omega$, $V_{out}(Ach)$, $R_L=47k\Omega$, $BW=400Hz-30kHz$, $VOL=0dB$, AGC Flat=500mV,

AGC Bst1=Low, $T_a=25^\circ C$

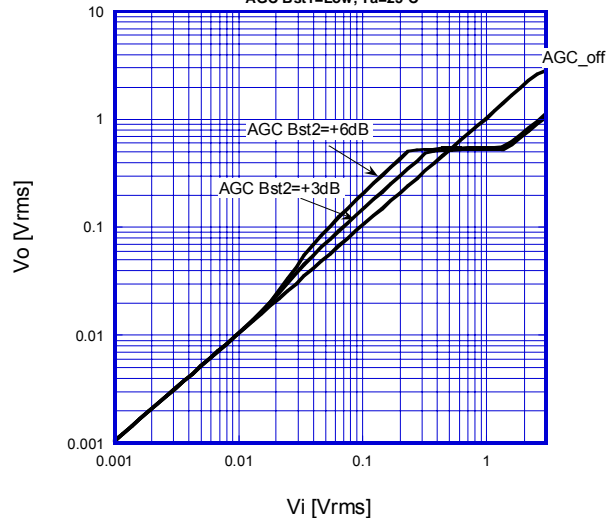

fig.22 AGC Characteristics (Attack)

$V^+=9V$, $V_{in}(A+Bch)=1Vrms$, $f=10kHz$, $R_g=600\Omega$, $V_{out}(Ach)$, $R_L=47k\Omega$, $VOL=0dB$, $R_{EXT}=100k\Omega$, $C_{EXT}=330nF$, AGC level=200mV, $T_a=25^\circ C$

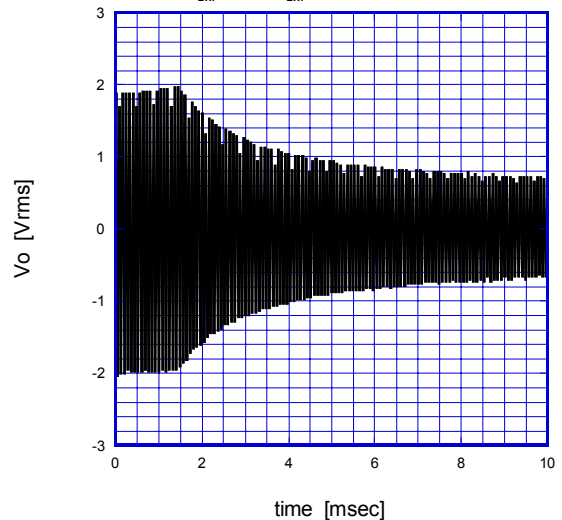
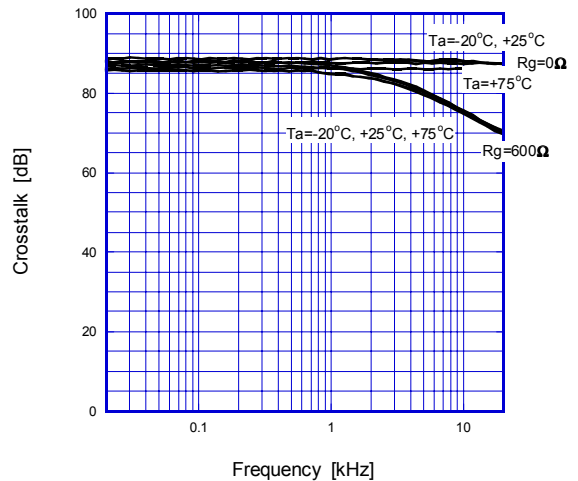

fig.24 Crosstalk vs Frequency

$V^+=9V$, $V_{in}(Ach IN2,IN3,IN4)=1Vrms$, SEL=IN1, $V_{out}(Ach)$, $R_L=47k\Omega$, $VOL=0dB$



■ TYPICAL CHARACTERISTICS

fig.25 Channel Separation vs Frequency

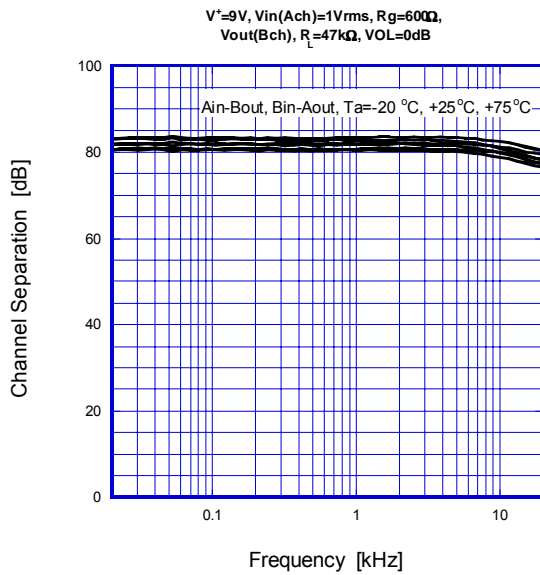

fig.27 Output Noise vs Temperature

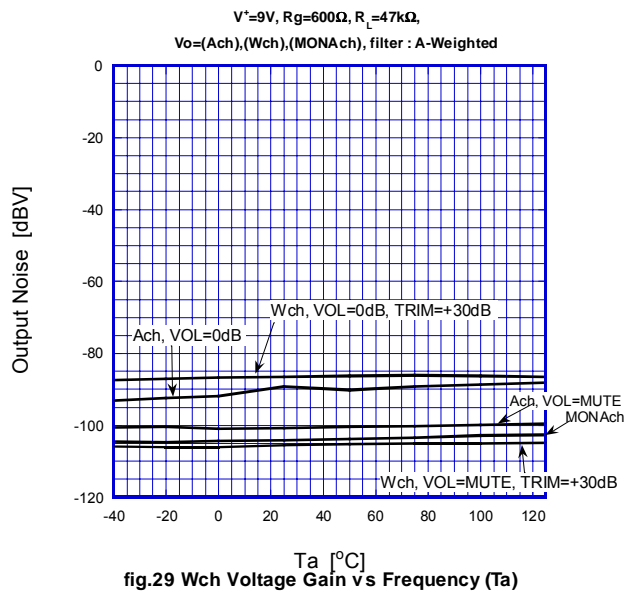

fig.29 Wch Voltage Gain vs Frequency (Ta)

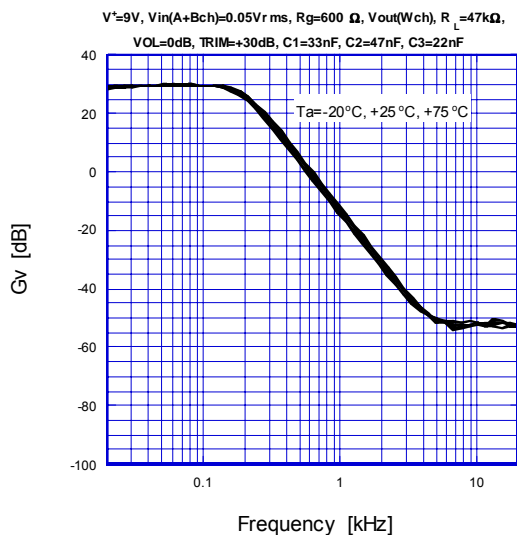

fig.26 Voltage Gain vs Frequency (MUTE)

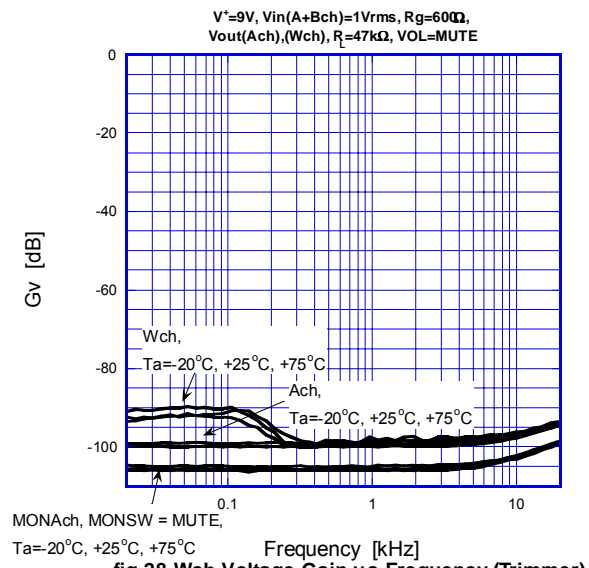

fig.28 Wch Voltage Gain vs Frequency (Trimmer)

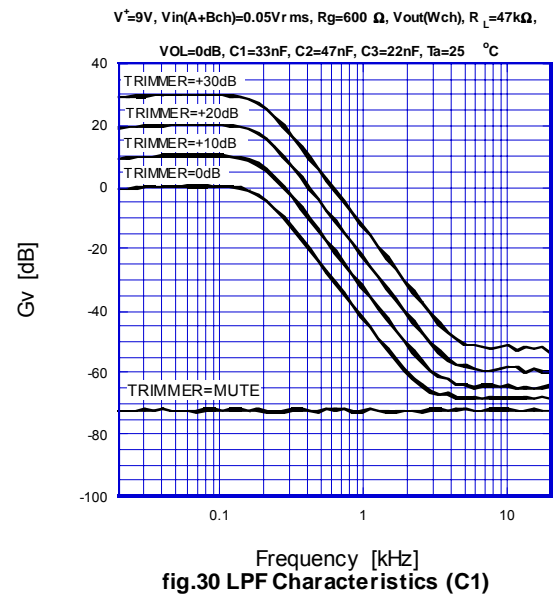
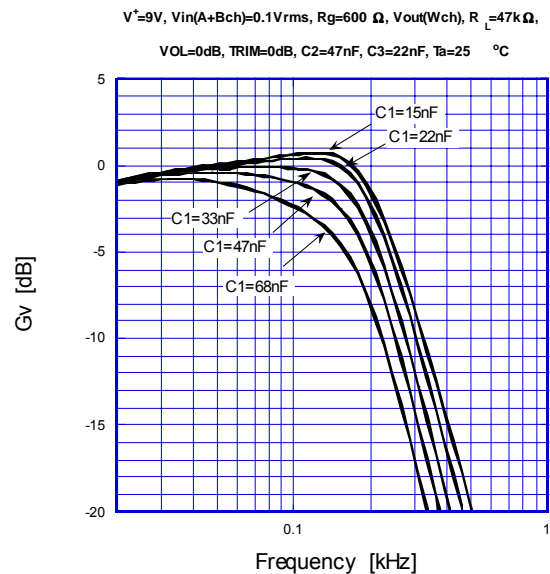

fig.30 LPF Characteristics (C1)



■ TYPICAL CHARACTERISTICS

fig.31 LPF Characteristics (C2)

$V^+=9V$, $V_{in}(A+Bch)=0.1V_{rms}$, $R_g=600\ \Omega$, $V_{out}(Wch)$, $R_L=47k\ \Omega$,
 $VOL=0dB$, $TRIM=0dB$, $C1=33nF$, $C3=22nF$, $T_a=25\ ^\circ C$

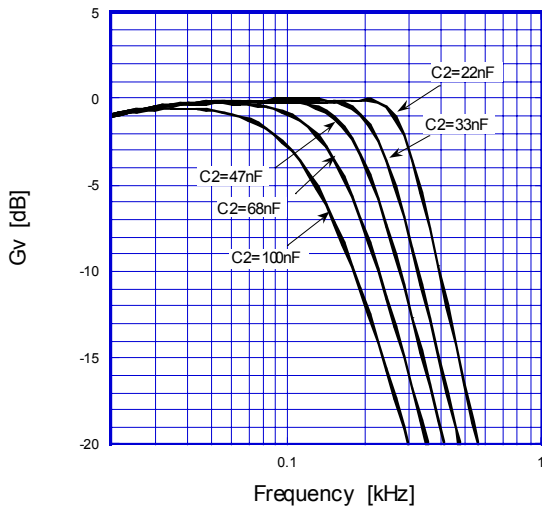

fig.33 Voltage Gain vs Frequency (Tone)

$V^+=9V$, $V_{in}(A)=0.1V_{rms}$, $R_g=600\ \Omega$, $V_{out}(Ach)$,
 $R_L=47k\ \Omega$, $VOL=0dB$, $T_a=25^\circ C$

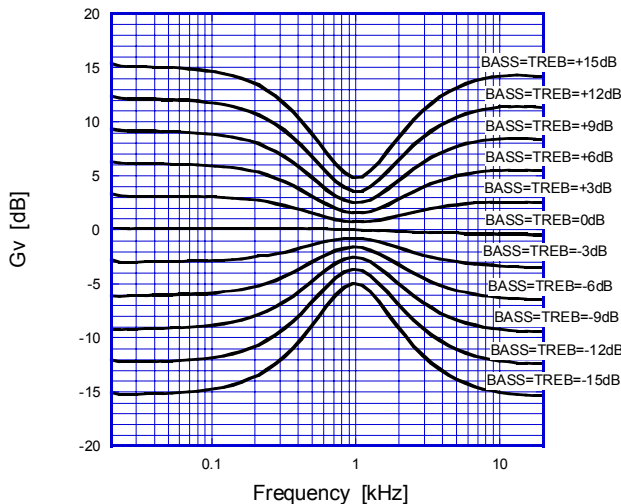

fig.35 Voltage Gain vs Frequency (eala effect1)

$V^+=9V$, $V_{in}=0.1V_{rms}$, $R_g=600\ \Omega$,
 $R_L=47k\ \Omega$, $VOL=0dB$

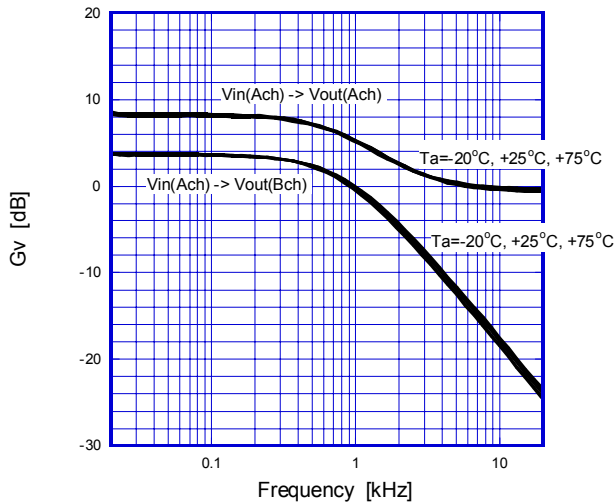

fig.32 LPF Characteristics (C3)

$V^+=9V$, $V_{in}(A+Bch)=0.1V_{rms}$, $R_g=600\ \Omega$, $V_{out}(Wch)$, $R_L=47k\ \Omega$,
 $VOL=0dB$, $TRIM=0dB$, $C1=33nF$, $C2=47nF$, $T_a=25\ ^\circ C$

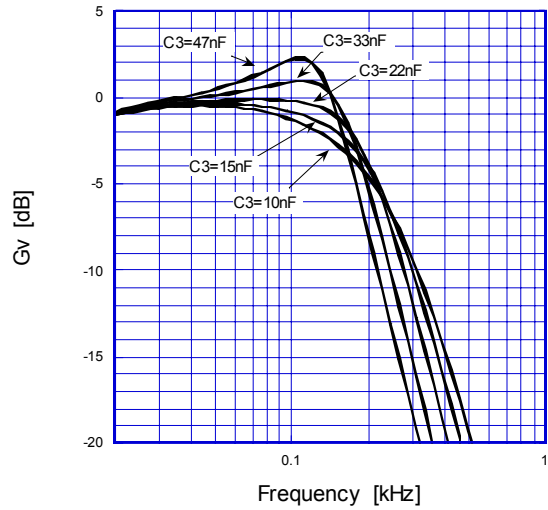

fig.34 Voltage Gain vs Frequency (Tone)

$V^+=9V$, $V_{in}(A)=0.1V_{rms}$, $R_g=600\ \Omega$, $V_{out}(Ach)$,
 $R_L=47k\ \Omega$, $VOL=0dB$

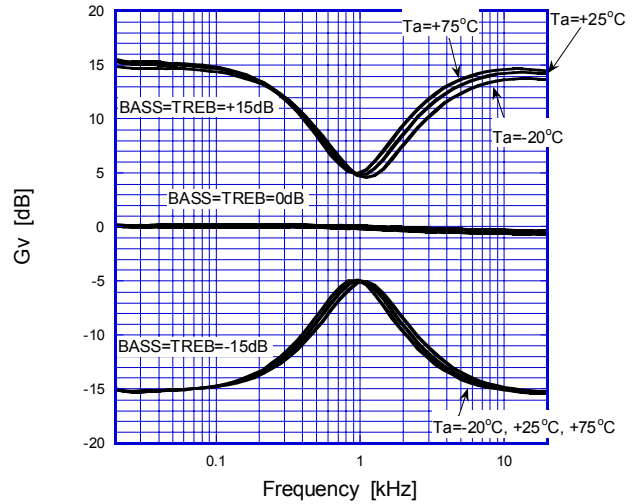
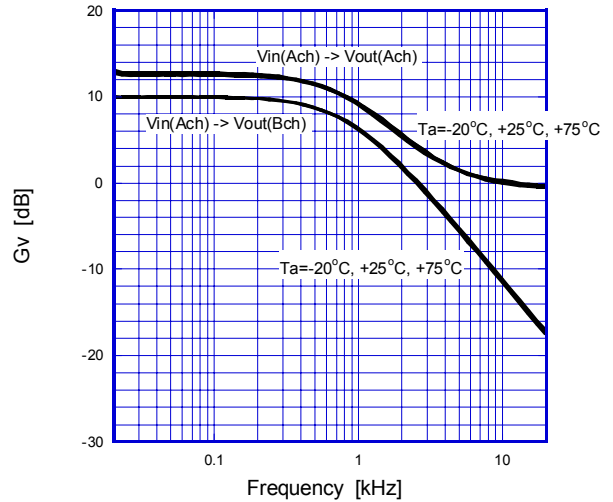

fig.36 Voltage Gain vs Frequency (eala effect2)

$V^+=9V$, $V_{in}=0.1V_{rms}$, $R_g=600\ \Omega$,
 $R_L=47k\ \Omega$, $VOL=0dB$



■ TYPICAL CHARACTERISTICS

fig.37 Voltage Gain vs Frequency (eala effect3)

$V^*=9V$, $V_{in}=0.1V_{rms}$, $R_g=600\Omega$,
 $R_L=47k\Omega$, $VOL=0dB$

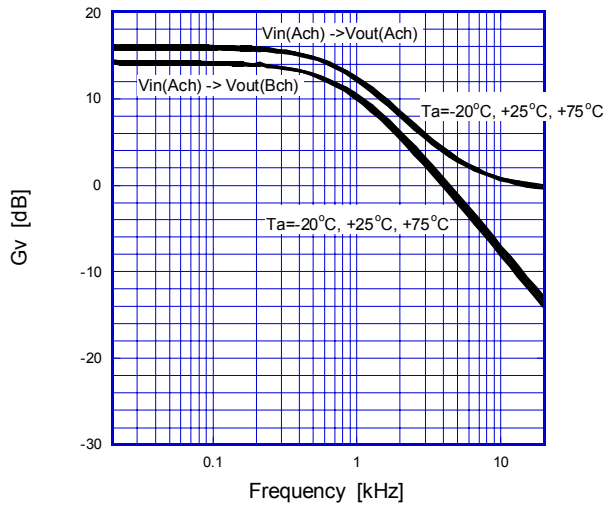

fig.39 Phase vs Frequency (Simulated Stereo)

$V^*=9V$, $V_{in}=0.1V_{rms}$, $R_g=600\Omega$,
 $R_L=47k\Omega$, $VOL=0dB$

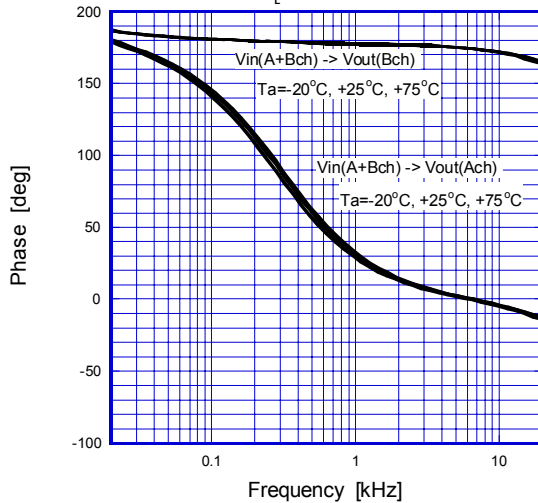

fig.41 Voltage Gain vs Frequency (Voice Enhancement)

$V^*=9V$, $V_{in(A+B)}=0.1V_{rms}$, $V_{out(Ach)}$, $R_g=600\Omega$,
 $R_L=47k\Omega$, $VOL=0dB$, VE effect 3

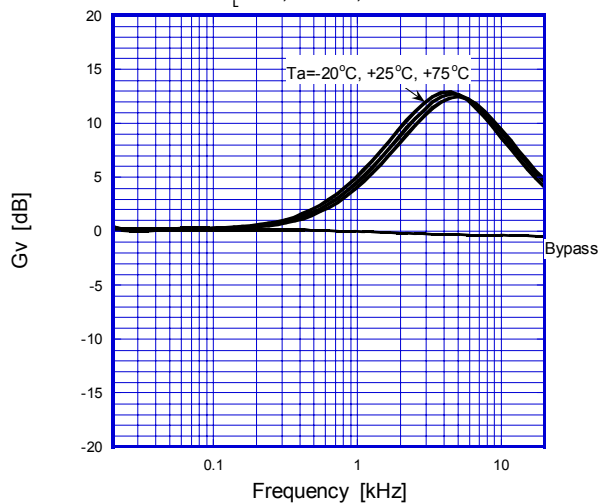

fig.38 Voltage Gain vs Frequency (Simulated Stereo)

$V^*=9V$, $V_{in}=0.1V_{rms}$, $R_g=600\Omega$,
 $R_L=47k\Omega$, $VOL=0dB$

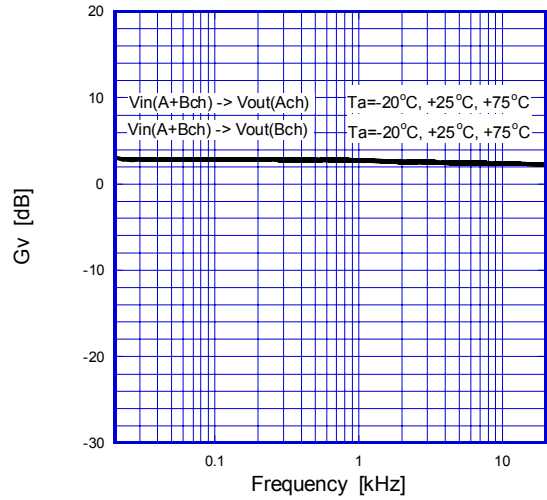
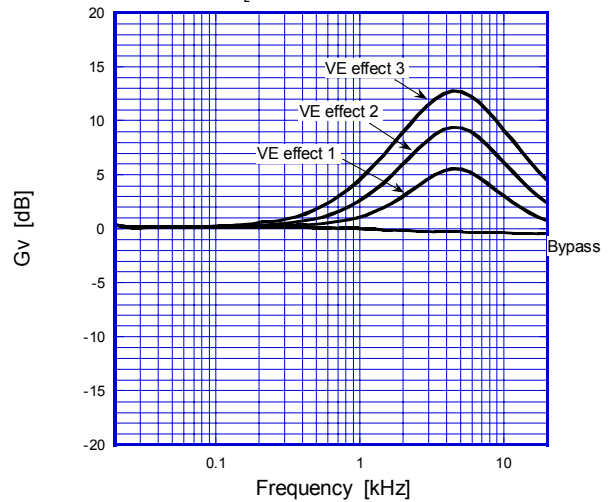

fig.40 Voltage Gain vs Frequency (Voice Enhancement)

$V^*=9V$, $V_{in(A+B)}=0.1V_{rms}$, $V_{out(Ach)}$, $R_g=600\Omega$,
 $R_L=47k\Omega$, $VOL=0dB$, $T_a=25^\circ C$



NOTE

Purchase of I²C components of New Japan Radio Co., Ltd or one of its sublicensed Associated Companies conveys a license under the Philips I²C Patent Rights to use these components in an I²C system, provided that the system conforms to the I²C Standard Specification as defined by Philips.

[CAUTION]

The specifications on this databook are only given for information, without any guarantee as regards either mistakes or omissions. The application circuits in this databook are described only to show representative usages of the product and not intended for the guarantee or permission of any right including the industrial rights.