

NJW1150

■ PIN FUNCTION

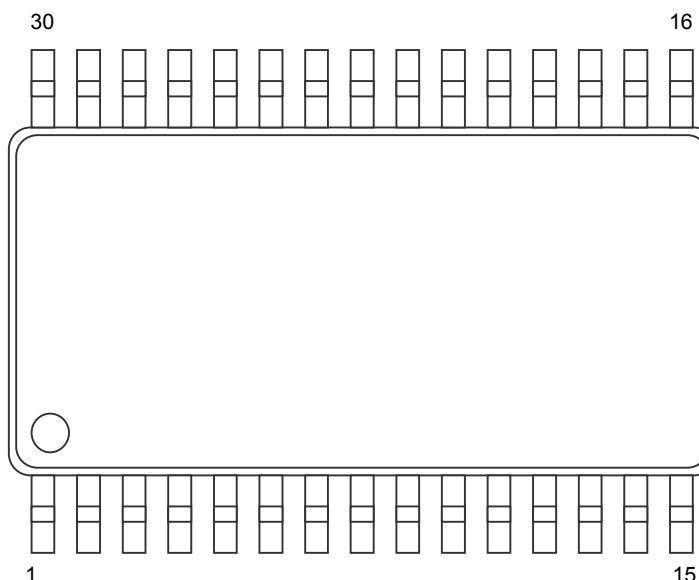

No.	SYMBOL	FUNCTION	No.	SYMBOL	FUNCTION
1	GND	Ground	16	SCL	I ² C bus clock input
2	V+	Positive power supply voltage	17	SDA	I ² C bus data input
3	VDD	Power supply voltage (Digital)	18	SWOUT	Volume Sub Woofer channel output
4	RTIN	Tone control Right channel input	19	SROUT	Volume Surround Right channel output
5	RTOUT	Tone control Right channel output	20	SLOUT	Volume Surround Left channel volume output
6	RTC	Tone control Right channel Treble filter capacitor	21	COUT	Volume Center channel output
7	RBC1	Tone control Right channel Bass filter capacitor	22	ROUT	Volume Right channel output
8	RBC2	Tone control Right channel Bass filter capacitor	23	LOUT	Volume Left channel output
9	RBC3	Tone control Right channel Bass DC cut capacitor	24	LBC3	Tone control Left channel Bass DC cut capacitor
10	LIN	Volume Left channel input	25	LBC2	Tone control Left channel Bass filter capacitor
11	RIN	Volume Right channel input	26	LBC1	Tone control Left channel Bass filter capacitor
12	CIN	Volume Center channel input	27	LTC	Tone control Left channel Treble filter capacitor
13	SLIN	Volume Surround Left channel input	28	LTOUT	Tone control Left channel output
14	SRIN	Volume Surround Right channel input	29	LTIN	Tone control Left channel input
15	SWIN	Volume Sub Woofer channel input	30	V-	Negative power supply voltage (IC substrate)

■ ABSOLUTE MAXIMUM RATING (Ta=25°C)

PARAMETER	SYMBOL	RATING	UNIT
Supply Voltage 1	V^+/V^-	+7.5/-7.5	V
Supply Voltage 2	V_{DD}	7.0	V
Maximum Input Voltage	V_{IM}	$V^+/V^-^{(*)}$	V
Power Dissipation	P_D	700	mW
Operating Temperature Range	Topr	-20 to +85	°C
Storage Temperature Range	Tstg	-40 to +125	°C

(*) For the maximum input voltage less than V^+/V^-

■ ELECTRICAL CHARACTERISTICS (Ta=25°C, $V^+/V^- = \pm 7V$, $V_{DD} = 5V$)

PARAMETER	SYMBOL	TEST CONDITION	MIN.	TYP.	MAX.	UNIT
-----------	--------	----------------	------	------	------	------

Power Supply

Operating Voltage 1	V^+/V^-		4.5	7.0	7.5	V
Operating Voltage 2	V_{DD}		4.5	5.0	5.5	V
Supply Current 1	I_{CC}	No Signal	-	8	14	mA
Supply Current 2	I_{EE}	No Signal	-	8	14	mA
Supply Current 3	I_{DD}	No Signal	-	10	100	μA

Input/Output Characteristics

Voltage Gain	G_V	$V_{IN} = 1V_{rms}$, $f = 1kHz$ Master=0dB, Balance=0dB Trimmer=0dB	-0.5	0	0.5	dB
Voltage Gain Error	ΔG_V	$V_{IN} = 1V_{rms}$, $f = 1kHz$ Master=0dB	-0.5	0	0.5	dB
Maximum Attenuation 1	A_{TT1}	$f = 1kHz$, $V_{IN} = 1V_{rms}$ Master=-79dB	-	-79	-	dB
Maximum Attenuation 2	A_{TT2}	$f = 1kHz$, $V_{IN} = 1V_{rms}$ Mute	-	-90	-	dB
Attenuation Error	ΔA_{TT}	$f = 1kHz$, $V_{IN} = 1V_{rms}$ Master=-50dB Trimmer=-10dB	-1	0	1	dB
Maximum Output Voltage	V_{OM}	$f = 1kHz$, THD=1% Master=0dB	3.0	4.0	-	Vrms
Output Noise	V_{NO}	Master=0dB, $R_g = 0, A$ -weight	-	-110 (3.2μ)	-100 (10μ)	dBV (Vrms)
Total Harmonic Distortion	T.H.D	$f = 1kHz$, $V_o = 1V_{rms}$, Master=0dB, Trimmer=0dB	-	0.005	0.05	%
Channel Separation	CS	$f = 1kHz$, $V_o = 1V_{rms}$ Master=0dB, A-weight	-	-90	-80	dB

Tone Control Characteristics

Treble Boost Gain1	HF_{BST}	$V_o = 1V_{rms}$ $f = 10kHz$ Treble=10dB	8	10	12	dB
Treble Boost Gain2	HF_{CUT}	$V_o = 1V_{rms}$ $f = 10kHz$ Treble=-10dB	-12	-10	-8	dB
Bass Boost Gain1	LF_{BST}	$V_o = 1V_{rms}$ $f = 50Hz$ Bass=10dB	8	10	12	dB
Bass Boost Gain2	LF_{CUT}	$V_o = 1V_{rms}$ $f = 50Hz$ Bass=-10dB	-12	-10	-8	dB

NJW1150

■ I²C BUS BLOCK CHARACTERISTICS (SDA, SCL)

PARAMETER	SYMBOL	MIN.	TYP.	MAX.	UNIT
High Level Input Voltage	V _{IH}	3.0	-	5.0	V
Low Level Input Voltage	V _{IL}	0	-	1.5	V
High Level Input Current	I _{IH}	-	-	10	μA
Low Level Input Current	I _{IL}	-	-	10	μA
Low Level Output Voltage (3mA at SDA pin)	V _{OL}	0	-	0.4	V
Maximum Output Current	I _{OL}	-3.0	-	-	mA
Maximum Clock Frequency	f _{SCL}	0	-	100	kHz
Data Change Minimum Waiting Time	t _{BUF}	4.7	-	-	μs
Data Transfer Start Minimum Waiting Time	t _{HD:STA}	4.0	-	-	μs
Low Level Clock Pulse Width	t _{LOW}	4.7	-	-	μs
High Level Clock Pulse Width	T _{HIGH}	4.0	-	-	μs
Minimum Start Preparation Waiting Time	t _{SU:STA}	4.7	-	-	μs
Minimum Data Hold Time	t _{HD:DAT}	5.0	-	-	μs
Minimum Data Preparation Time	t _{SU:DAT}	250	-	-	ns
Rise Time	t _R	-	-	1.0	μs
Fall Time	t _F	-	-	300	ns
Minimum Stop Preparation Waiting Time	t _{SU:STO}	4.7	-	-	μs

I²C BUS Load Condition: Pull up resistance 4kΩ (Connected to +5V)
Load capacitance 200pF (Connected to GND)

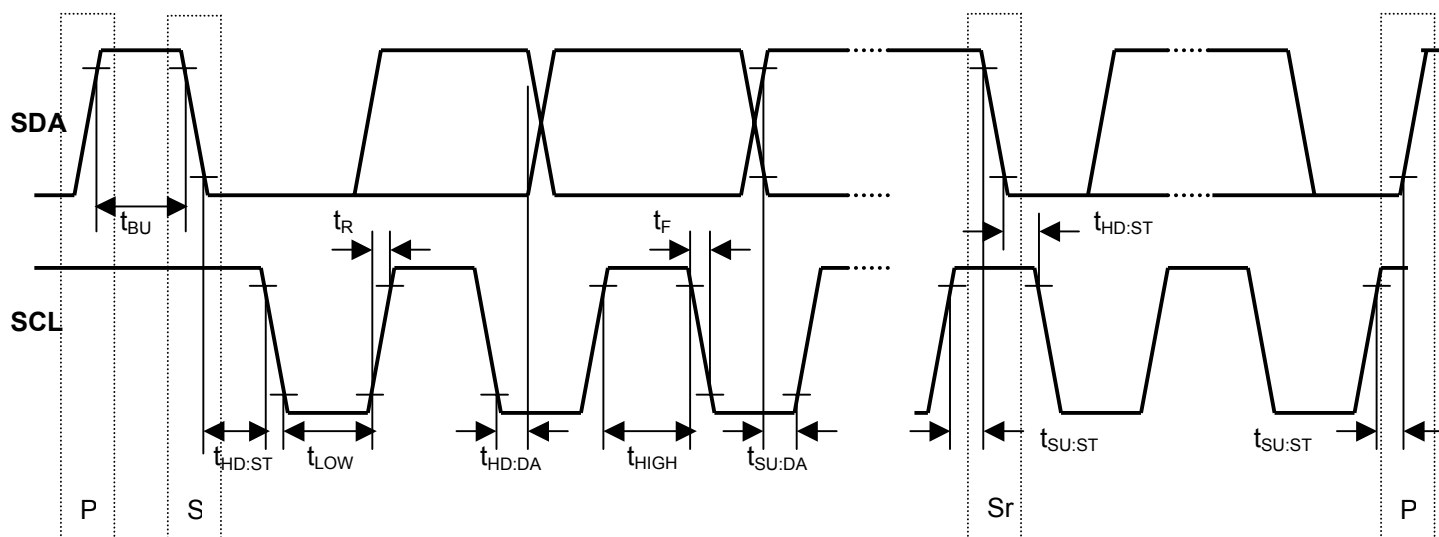

■ TERMINAL DESCRIPTION

PIN NO.	SYMBOL	FUNCTION	EQUIVALENT CIRCUIT	TERMINAL VOLTAGE
1	GND	Ground		0
2 3	V+ VDD	Positive power supply voltage Power supply voltage (Digital)		V+ VDD
4 29	RTIN LTIN	Tone control Right channel input Left channel input		0
5 28	RTOUT LTOUT	Tone control Right channel output Left channel output		0

NJW1150

■ TERMINAL DESCRIPTION

PIN NO.	SYMBOL	FUNCTION	EQUIVALENT CIRCUIT	TERMINAL VOLTAGE
6 27	RTC LTC	Tone control Right channel Treble filter capacitor Left channel Treble filter capacitor		0
7 26	RBC1 LBC1	Tone control Right channel Bass filter capacitor Left channel Bass filter capacitor		0
8 25	RBC2 LBC2	Tone control Right channel Bass filter capacitor Left channel Bass filter capacitor		0
9 24	RBC3 LBC3	Tone control Right channel Bass DC cut capacitor Left channel Bass DC cut capacitor		0

■ TERMINAL DESCRIPTION

PIN NO.	SYMBOL	FUNCTION	EQUIVALENT CIRCUIT	TERMINAL VOLTAGE
10 11 12 13 14 15	LIN RIN CIN SLIN SRIN SWIN	Volume Left channel input Right channel input Center channel input Surround Left channel input Surround Right channel input Sub Woofer channel input		0
16	SCL	I ² C bus clock input		5
17	SDA	I ² C bus data input		5
18 19 20 21 22 23	SWOUT SROUT SLOUT COUT ROUT LOUT	Volume Left channel output Right channel output Center channel output Surround Left channel output Surround Right channel output Sub Woofer channel output		0

NJW1150

APPLICATION CIRCUIT

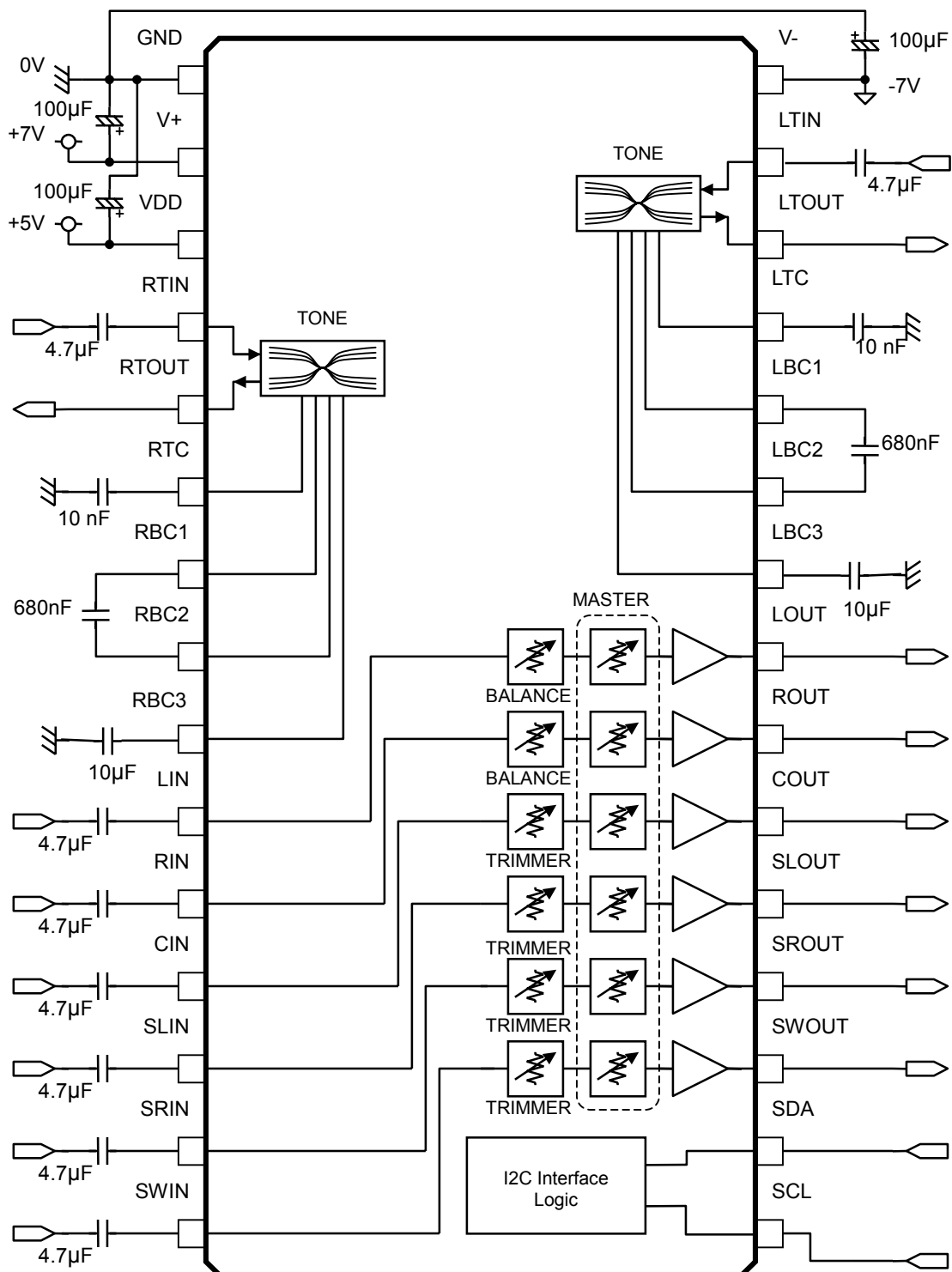

■ Definition of cut-off frequency for Tone Control

Cut-off frequency for Tone Control is adjustable with changing the capacitor C1, C2 in below circuit. See the next function for the cut-off frequency.

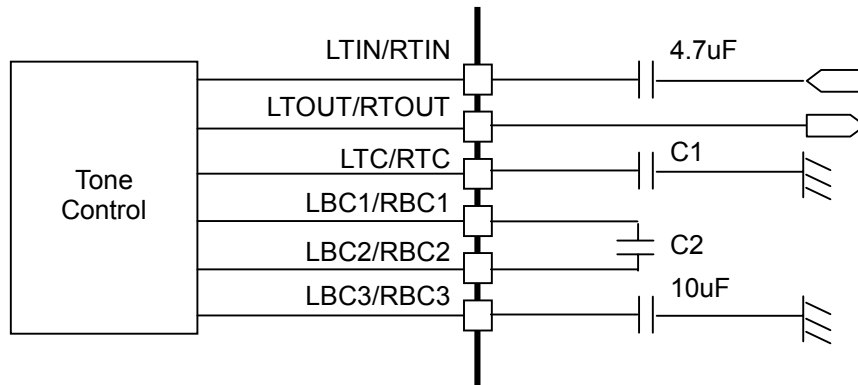

EX) C1 = 10uF, C2 = 680nF
 Cut-off frequency for Treble = 3.9kHz
 Cut-off frequency for Bass = 238Hz

1) TREBLE = +/-10dB

2) BASS = +/-10dB

$$f_c = \frac{39.2 * 10^{-6}}{C1}$$

$$f_c = \frac{161.7 * 10^{-6}}{C2}$$

NJW1150

■ DEFINITION OF I²C REGISTER

● I²C BUS FORMAT

S: Starting Term A: Acknowledge Bit P: Ending Term



● SLAVE ADDRESS

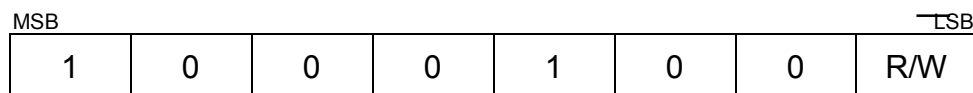

R/W=0: Receive Only

R/W=1: No Output Data

● CONTROL REGISTER TABLE

Select Address	BIT							
	D7	D6	D5	D4	D3	D2	D1	D0
00H	*	Master Volume						
01H	*			Left channel Balance				
02H	*			Right channel Balance				
03H	*			Center Channel Trimmer				
04H	*			SL Channel Trimmer				
05H	*			SR Channel Trimmer				
06H	*			SW Channel Trimmer				
07H	Tone (Treble)				Tone (Bass)			
08H	*	MUTE						

* : Don't care.

On Power up, the master volume mute is activated.

● CONTROL REGISTER DEFAULT VALUE

Select Address	BIT							
	D7	D6	D5	D4	D3	D2	D1	D0
00H	0	1	0	1	0	0	0	0
01H	0	0	0	0	0	0	0	0
02H	0	0	0	0	0	0	0	0
03H	0	0	0	0	1	0	1	0
04H	0	0	0	0	1	0	1	0
05H	0	0	0	0	1	0	1	0
06H	0	0	0	0	1	0	1	0
07H	0	0	0	0	0	0	0	0
08H	0	0	0	0	0	0	0	0

NJW1150

● CONTROL COMMAND TABLE

Select Address	BIT								REMARKS
	D7	D6	D5	D4	D3	D2	D1	D0	
07H	TREBLE				BASS				TONE CONTROL Ex.) "11011101"=+10dB "11001100"=+8dB : "10001000"=0dB "00000000"=0dB : "01000111"=-8dB "01010101"=-10dB
	1	1	0	1	1	1	0	1	
	1	1	0	0	1	1	0	0	
	:	:	:	:	:	:	:	:	
	1	0	0	0	1	0	0	0	
	0	0	0	0	0	0	0	0	
	:	:	:	:	:	:	:	:	
0	1	0	0	0	1	0	0		
0	1	0	1	0	1	0	1		
08H	MUTE								MUTE CONTROL Ex.) "0"=OFF "1"=MUTE D5=L ch,D4=R ch,D3=C ch,D2=SL ch,D1=SR ch,D0=SW ch
	0								
	1								

■ TYPICAL CHARACTERISTICS

Operating Current vs. Supply Voltage
Ta=25°C

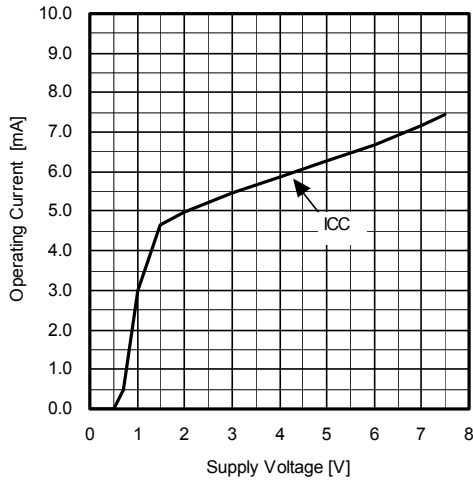

Operating Current vs. Supply Voltage
Ta=25°C

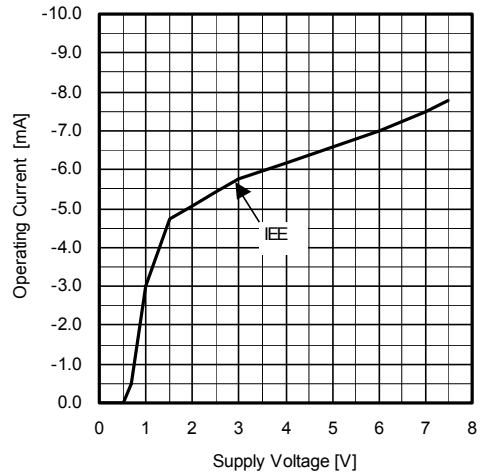

Operating Current vs. Supply Voltage
Ta=25°C

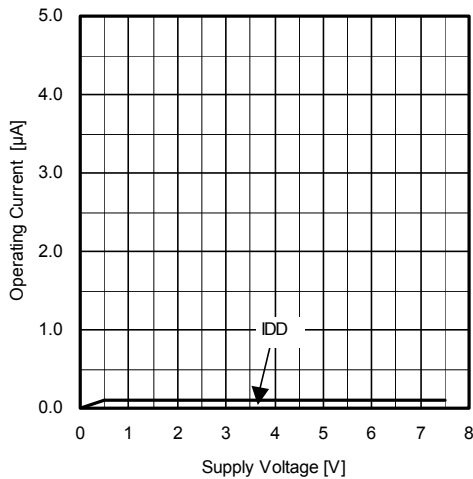

Attenuation Level vs. Setting Level
Ta=25°C

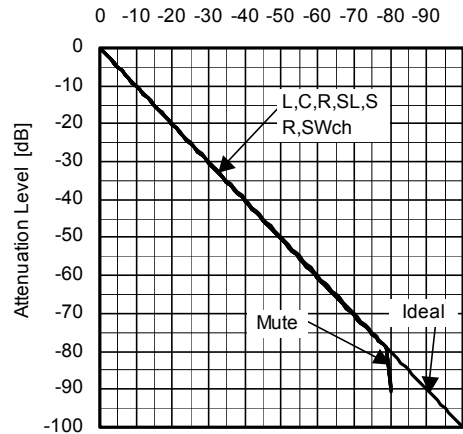

Tone Control Gain vs Frequency
Ta=25°C

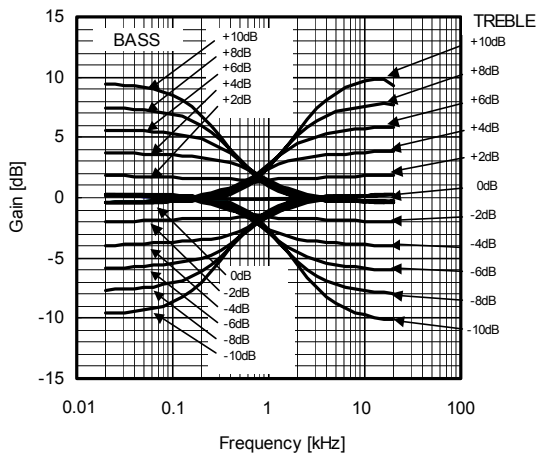

Volume THD+N vs. Input Level
0dB Setting Ta=25°C

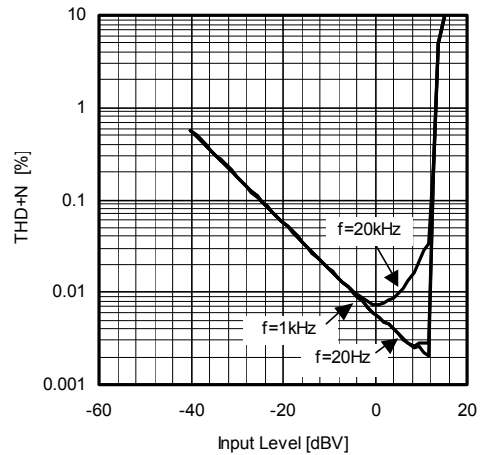

NJW1150

TYPICAL CHARACTERISTICS

Volume THD+N vs. Input Level
Variation Ta=25°C

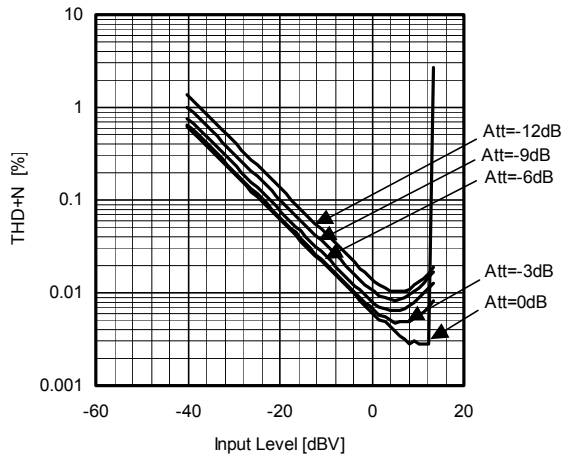

Tone Control THD+N vs. Input Level
Flat (0dB) Setting Ta=25°C

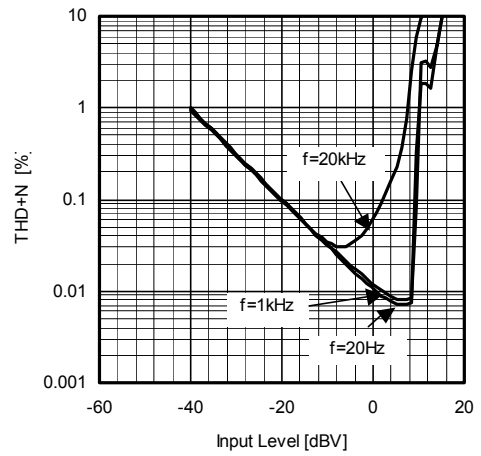

Tone Control THD+N vs. Frequency
Flat (0dB) Setting Ta=25°C

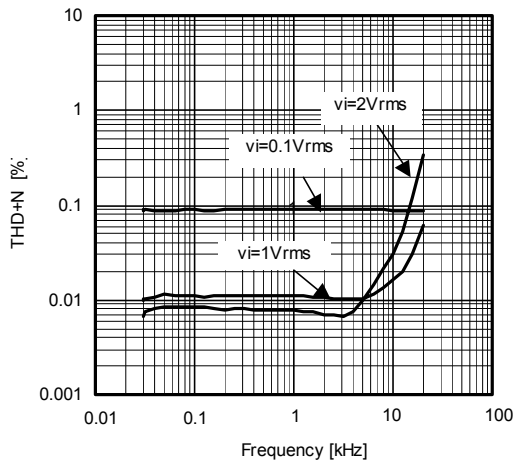

Supply Current vs. Ambient Temperature
ICC V+=7V V-=-7V Vdd=5V

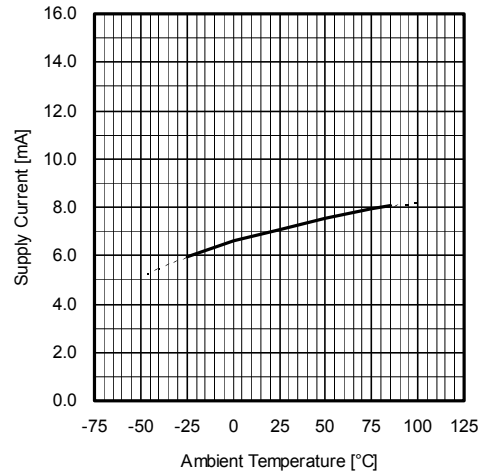

Supply Current vs. Ambient Temperature
IEE V+=7V V-=-7V Vdd=5V

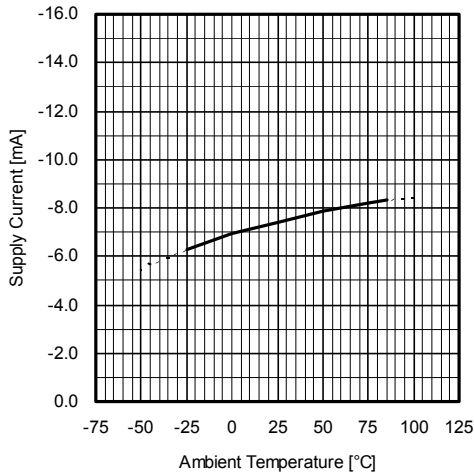

Supply Current vs. Ambient Temperature
IDD V+=7V V-=-7V Vdd=5V

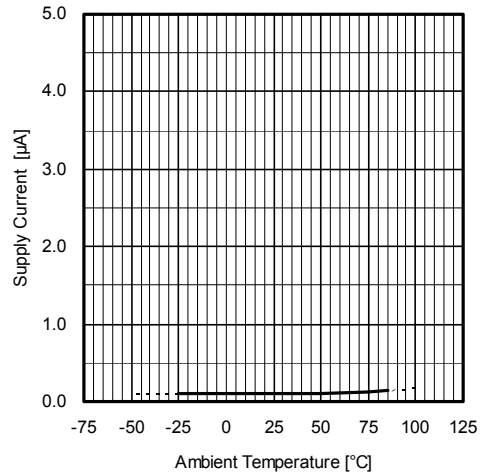

■ TYPICAL CHARACTERISTICS

Volume Gain vs. Ambient Temperature
 V+=7V V-=7V Vdd=5V, 0dB Setting

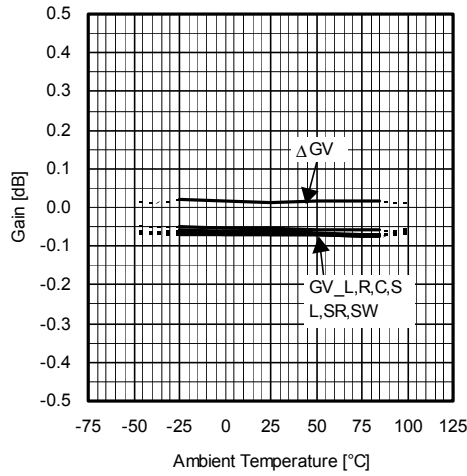

Volume Attenuation Level vs. Ambient Temperature
 V+=7V V-=7V Vdd=5V, -79dB Setting

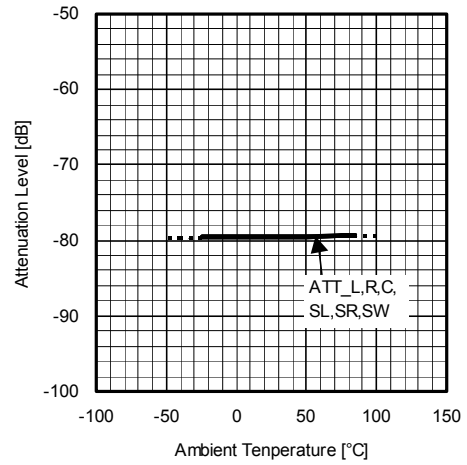

Volume Attenuation Level vs. Ambient Temperature
 V+=7V V-=7V Vdd=5V, Mute Setting

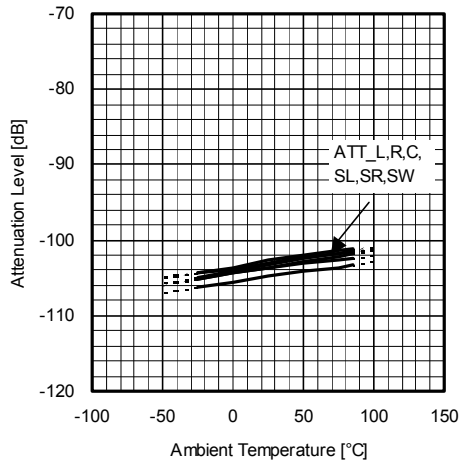

Volume Attenuation Level vs. Ambient Temperature
 V+=7V V-=7V Vdd=5V
 -60dB(Master=-50dB, Trimmer=-10dB) Setting

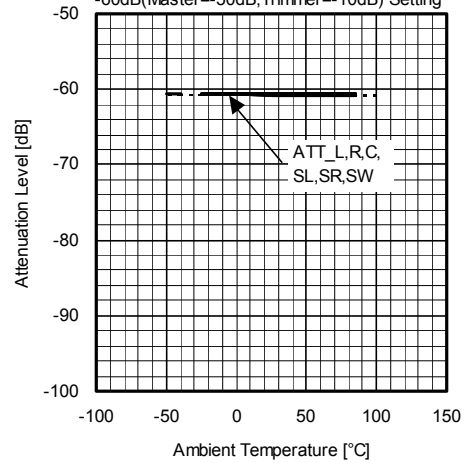

Volume Maximum Output Voltage vs. Ambient Temperature
 V+=7V V-=7V Vdd=5V, 0dB Setting

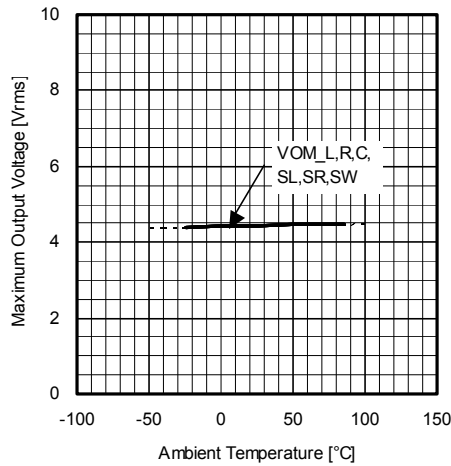

Volume Output Noise vs. Ambient Temperature
 V+=7V V-=7V Vdd=5V, 0dB Setting

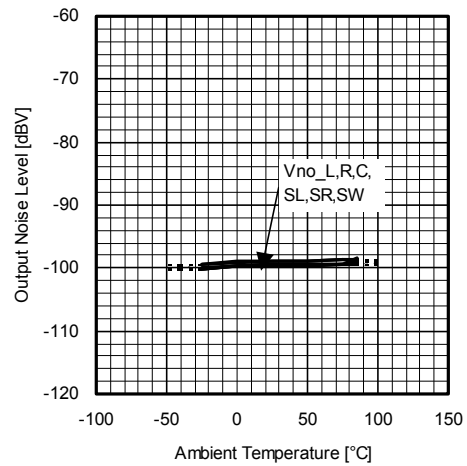

■ TYPICAL CHARACTERISTICS

Volume THD+N vs. Ambient Temperature
 $V_{+}=7V$ $V_{-}=-7V$ $V_{dd}=5V$, 0dB Setting

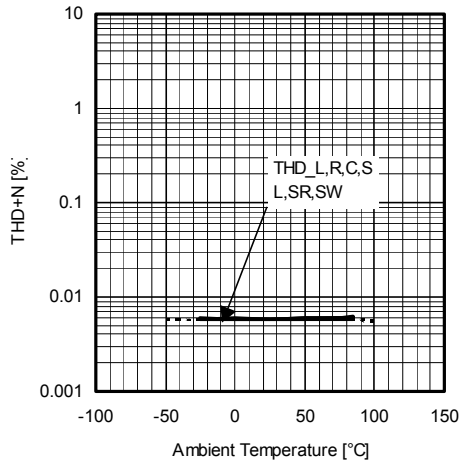

Tone Control Output Level vs. Ambient Temperature
 $V_{+}=7V$ $V_{-}=-7V$ $V_{dd}=5V$

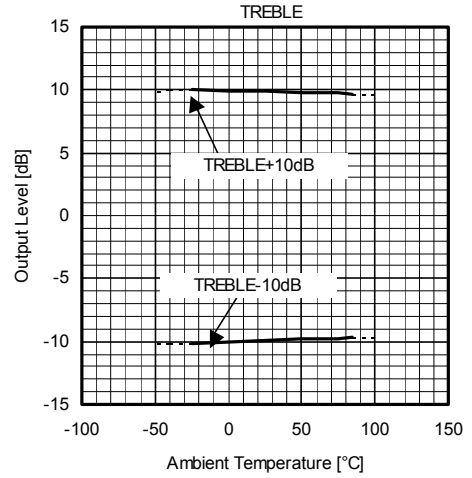

Tone Control Output Level vs. Ambient Temperature
 $V_{+}=7V$ $V_{-}=-7V$ $V_{dd}=5V$

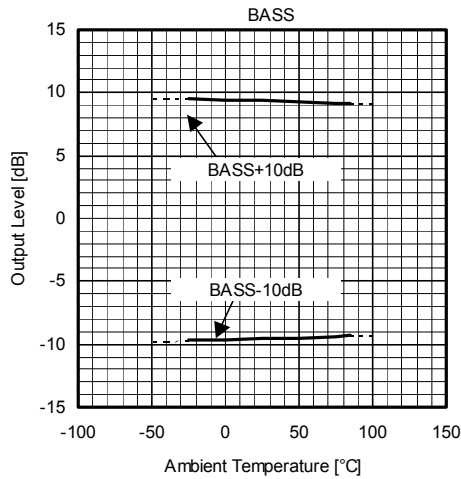

Volume THD+N vs. Input Level
 0dB Setting $f=1kHz$

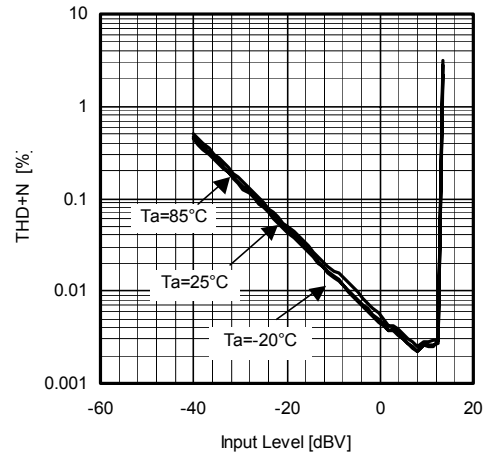

Tone Control THD+N vs. Input Level
 Flat (0dB) Setting $f=1kHz$

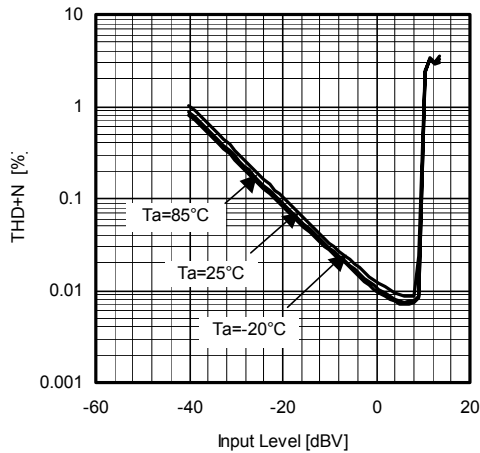

■ NOTE

Purchase of I²C components of New Japan Radio Co., Ltd or one of its sublicensed Associated Companies conveys a license under the Philips I²C Patent Rights to use these components in an I²C system, provided that the system conforms to the I²C Standard Specification as defined by Philip.

[CAUTION]

The specifications on this databook are only given for information, without any guarantee as regards either mistakes or omissions. The application circuits in this databook are described only to show representative usages of the product and not intended for the guarantee or permission of any right including the industrial rights.