



## AUDIO PROCESSOR with SOUND ENHANCEMENT

### ■ GENERAL DESCRIPTION

The **NJW1132A** is a sound processor with sound enhancement (BBE). It includes all of functions processing audio signal for TV, such as tone control, balance, volume, mute, and AGC functions.

Also the **NJW1132A** performs surround and sound enhancement. The sound enhancement regenerates high definitive and nearly real sound.

All of internal status and variables are controlled by I<sup>2</sup>C BUS interface.

### ■ PACKAGE OUTLINE

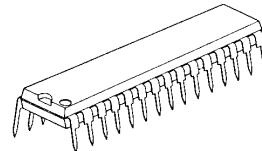

NJW1132AL

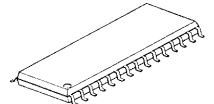

NJW1132AM

### ■ FEATURES

- Operating Voltage           8 to 13V
- I<sup>2</sup>C BUS Interface
- BBE Sound Enhancement (Low Boost and High Boost: 15dB max.)
- AGC Circuit (It reduces volume difference among input sources.)
- Matrix Surround
- Bi-CMOS Technology
- Package Outline           SDIP30, SDMP30

### ■ BLOCK DIAGRAM

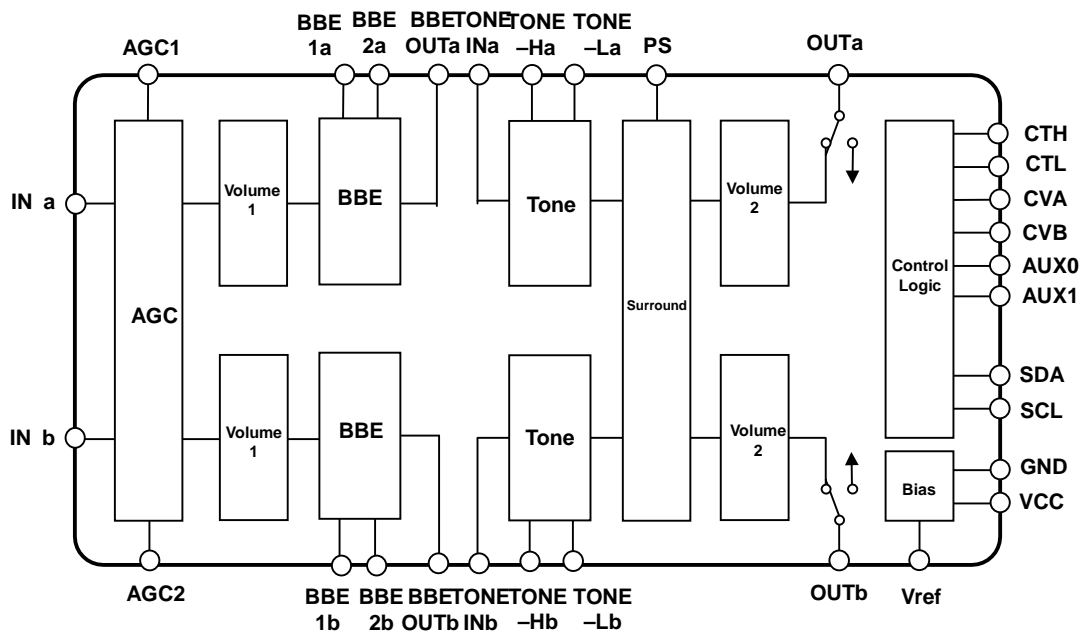

# NJW1132A

## ■ PIN FUNCTION



No.	Symbol	Function	No.	Symbol	Function
1	INa	Ach Input	16	Vcc	Power Supply Pin
2	BBE1a	Ach BBE Filter1	17	AUX1	Auxiliary Output1
3	BBE2a	Ach BBE Filter2	18	AUX0	Auxiliary Output0
4	BBEOUTa	Ach BBE Output	19	CTL	DAC Output for Tone Low Frequency
5	TONEINa	Ach Tone Input	20	CTH	DAC Output for Tone High Frequency
6	TONE-Ha	Ach Treble Filter	21	VREF	Reference Voltage
7	TONE-La	Ach Bass Filter	22	PS	Surround Phase Shift Filter
8	OUTa	Ach Output(0dB)	23	OUTb	Bch Output(0dB)
9	AGC1	AGC1	24	TONE-Lb	Bch Bass Filter
10	AGC2	AGC2	25	TONE-Hb	Bch Treble Filter
11	CVB	DAC Output for Bch Volume & Balance	26	TONEINb	Bch Tone Input
12	CVA	DAC Output for Ach Volume & Balance	27	BBEOUTb	Bch BBE Output
13	SDA	SDA Data Input (I2C BUS)	28	BBE2b	Bch BBE Filter2
14	SCL	SCL Data Input (I2C BUS)	29	BBE1b	Bch BBE Filter1
15	GND	GND	30	INb	Bch Input

## ■ABSOLUTE MAXIMUM RATING (Ta=25°C)

PARAMETER	SYMBOL	RATING	UNIT
Supply Voltage	V <sup>+</sup>	14	V
Power Dissipation	P <sub>D</sub>	700	mW
Operating Temperature Range	Topr	-20 to +75	°C
Storage Temperature Range	Tstg	-40 to +125	°C

## ■ELECTRICAL CHARACTERISTICS (Ta=25°C, V+=9V, Rg=600Ω, RL=47kΩ, Vin=100mVrms/1kHz)

PARAMETER	SYMBOL	TEST CONDITION	MIN.	TYP.	MAX.	UNIT
Operating Voltage	V+		8.0	9.0	13.0	V
Supply Current	I <sub>CC</sub>	No Signal	-	25	35	mA
Reference Voltage	V <sub>REF</sub>	No Signal	4.0	4.5	5.0	V
Maximum Input Voltage	V <sub>IM</sub>	VOL=C3H(-20dB),THD=1%	2.3	2.5	-	Vrms
Maximum Output Voltage	V <sub>OM1</sub>	OUTPUT VOL=FFH,THD=1%	-	2.5	-	Vrms
Maximum Gain	G <sub>VMAX</sub>	VOL=FFH	-2.0	0.0	2.0	dB
Minimum Gain	G <sub>VMIN</sub>	VOL=00H	-	-	-70	dB
Channel Balance	G <sub>CB</sub>	VOL=FFH	-1.5	0.0	1.5	dB
Balance Boost A	BA <sub>BST</sub>	CHS="0",BAL="11111"	-2.0	0.0	2.0	dB
Balance Cut A	BA <sub>CUT</sub>	CHS="1",BAL="11111" Vin = 1Vrms	-	-	-70	dB
Balance Boost B	BB <sub>BST</sub>	CHS="1",BAL="11111"	-2.0	0.0	2.0	dB
Balance Cut B	BB <sub>CUT</sub>	CHS="0",BAL="11111" Vin = 1Vrms	-	-	-70	dB
Total Harmonic Distortion	THD	Vo=0.5Vrms BW=400Hz to 30kHz	-	-	0.5	%
Maximum Gain	G <sub>VMAX</sub>	VOL=FFH	-2.0	0.0	2.0	dB
Minimum Gain	G <sub>VMIN</sub>	VOL=00H	-	-	-70	dB
Channel Separation	CS	Vin=2Vrms	-	-	-70	dB
Output Noise 1	V <sub>NO1</sub>	VOL=FFH BW=400Hz to 30kHz	-	-80 (100)	-70 (316)	dBV (μVrms)
Output Noise 2	V <sub>NO2</sub>	VOL=00H BW=400Hz to 30kHz	-	-90 (31.6)	-82 (79.4)	dBV (μVrms)
AUX Output Voltage	V <sub>AUX</sub>	Logic Output : High	4.5	-	5.0	V
		Logic Output : Low	0	-	0.3	

BW : Band Width

● **TONE CONTROL** (Ta=25°C, V+=9V, Rg=600Ω, RL=47kΩ, Vin=100mVrms/1kHz)

PARAMETER	SYMBOL	TEST CONDITION	MIN.	TYP.	MAX.	UNIT
High Frequency Boost	HF <sub>BST</sub>	BCT="1", TREB="1111", f=10kHz	12.5	15.0	17.5	dB
High Frequency Flat	HF <sub>FLT</sub>	TRBE="0000", f=10kHz	-2.0	0.0	2.0	dB
High Frequency Cut	HF <sub>CUT</sub>	BCT="0", TRBE="1111", f=10kHz	-12.5	-15.0	-17.5	dB
Low Frequency Boost	LF <sub>BST</sub>	BCB="1", BASS="1111", f=100Hz	12.5	15.0	17.5	dB
Low Frequency Flat	LF <sub>FLT</sub>	BASS="0000", f=100Hz	-2.0	0.0	2.0	dB
Low Frequency Cut	LF <sub>CUT</sub>	BCB="0", BASS="1111", f=100Hz	-12.5	-15.0	-17.5	dB
High Frequency Cut DC Offset1	HF <sub>DC1</sub>	BCT="0", TREB="1111" →"0000"	-1.0	0.0	1.0	V
High Frequency Boost DC Offset2	HF <sub>DC2</sub>	BCT="1", TREB="1111" →"0000"	-1.0	0.0	1.0	V
Low Frequency Cut DC Offset1	LF <sub>DC1</sub>	BCB="0", BASS="1111" →"0000"	-1.0	0.0	1.0	V
Low Frequency Boost DC Offset2	LF <sub>DC2</sub>	BCB="1", BASS="1111" →"0000"	-1.0	0.0	1.0	V

● **SUB-TONE CONTROL** (Ta=25°C, V+=9V, Rg=600Ω, RL=47kΩ, Vin=100mVrms)

PARAMETER	SYMBOL	TEST CONDITION	MIN.	TYP.	MAX.	UNIT
High Frequency Boost	SHF <sub>BST</sub>	BCST="0", SUB-TREB="11", f=10kHz	2.0	3.0	4.0	dB
High Frequency Flat	SHF <sub>FLT</sub>	SUB-TREB="00", f=10kHz	-2.0	0.0	2.0	dB
High Frequency Cut	SHF <sub>CUT</sub>	BCST="0", SUB-TREB="11", f=10kHz	-4.0	-3.0	-2.0	dB
Low Frequency Boost	SLF <sub>BST</sub>	BCSB="1", SUB-BASS="11", f=100Hz	2.0	3.0	4.0	dB
Low Frequency Flat	SLF <sub>FLT</sub>	SUB-BASS="00", f=100Hz	-2.0	0.0	2.0	dB
Low Frequency Cut	SLF <sub>CUT</sub>	BCSB="1", SUB-BASS="11", f=100Hz	-4.0	-3.0	-2.0	dB

● **AGC CONTROL: AGC=1H (AGC-ON)** (Ta=25°C, V+=9V, Rg=600Ω, RL=47kΩ, f=1kHz)

PARAMETER	SYMBOL	TEST CONDITION	MIN.	TYP.	MAX.	UNIT
AGC BOOST	AGC <sub>BST</sub>	Vin=50mVrms	1.5	3.5	5.5	dB
AGC FLAT	AGC <sub>FLT</sub>	Vin=150mVrms	-2.5	0.0	2.5	dB
AGC CUT	AGC <sub>CUT</sub>	Vin=2Vrms	-14	-10	-6.0	dB

● **SURROUND CONTROL** (Ta=25°C, V+=9V, Rg=600Ω, RL=47kΩ, Vin=100mVrms/1kHz)

PARAMETER	SYMBOL	TEST CONDITION	MIN.	TYP.	MAX.	UNIT
SURROUND MIX 1	SR <sub>MIX1</sub>	Ain → Bout	-2.0	0.0	2.0	dB
SURROUND MIX 2	SR <sub>MIX2</sub>	Bin → Aout	-2.0	0.0	2.0	dB
SURROUND DEF	SR <sub>DEF</sub>	Ain-Bin(-180deg)	8.0	10.0	12.0	dB
DC Offset	SR <sub>DC</sub>	SUR="0" →"1"	-1.0	0.0	1.0	V

● **BBE =1H (BBE-ON)** ( $T_a=25^\circ\text{C}$ ,  $V_+=9\text{V}$ ,  $R_g=600\Omega$ ,  $R_l=47\text{k}\Omega$ ,  $V_{in}=100\text{mVrms}$ )

PARAMETER	SYMBOL	TEST CONDITION	MIN.	TYP.	MAX.	UNIT
BBE low Frequency Boost Range	$\text{BBE}_{\text{LOW}}$	BBE-Low="1111", $f = 50\text{Hz}$	-	15.0	-	dB
BBE High Frequency Boost Range	$\text{BBE}_{\text{HIGH}}$	BBE-High="1111", $f = 10\text{KHz}$	-	15.0	-	dB

## ■ APPLICATION CIRCUIT

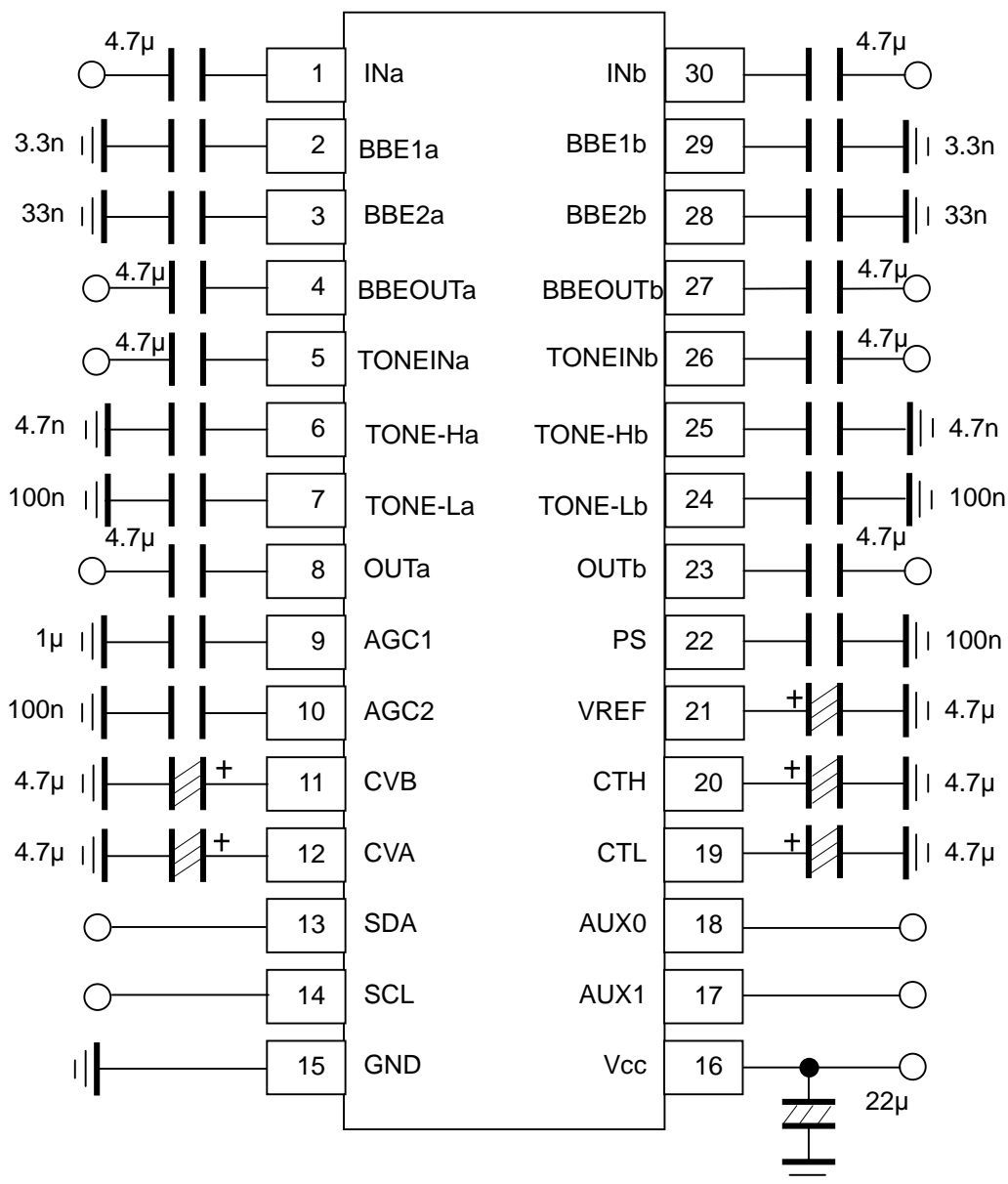

## ■ I<sup>2</sup>C BUS Block CHARACTERISTICS (SDA,SCL)

PARAMETER	SYMBOL	MIN.	TYP.	MAX.	UNIT
High Level Input Voltage	$V_{IH}$	3.0	-	5.0	V
Low Level Input Voltage	$V_{IL}$	0	-	1.5	V
High Level Input Current	$I_{IH}$	-	-	10	$\mu$ A
Low Level Input Current	$I_{IL}$	-	-	10	$\mu$ A
Low Level Output Voltage (3mA at SDA pin)	$V_{OL}$	0	-	0.4	V
Maximum Output Current	$I_{OL}$	-3.0	-	-	mA
Maximum Clock Frequency	$f_{SCL}$	0	-	100	kHz
Data Change Minimum Waiting Time	$t_{BUF}$	4.7	-	-	$\mu$ S
Data Transfer Start Minimum Waiting Time	$t_{HD:STA}$	4.0	-	-	$\mu$ S
Low Level Clock Pulse Width	$t_{LOW}$	4.7	-	-	$\mu$ S
High Level Clock Pulse Width	$T_{HIGH}$	4.0	-	-	$\mu$ S
Minimum Start Preparation Waiting Time	$t_{SU:STA}$	4.7	-	-	$\mu$ S
Minimum Data Hold Time	$t_{HD:DAT}$	5.0	-	-	$\mu$ S
Minimum Data Preparation Time	$t_{SU:DAT}$	250	-	-	nS
Rise Time	$t_R$	-	-	1.0	$\mu$ S
Fall Time	$t_F$	-	-	300	nS
Minimum Stop Preparation Waiting Time	$t_{SU:STO}$	4.7	-	-	$\mu$ S

I<sup>2</sup>C BUS Load Condition: Pull up resistance 4k $\Omega$  (Connected to +5V)  
Load capacitance 200pF (Connected to GND)

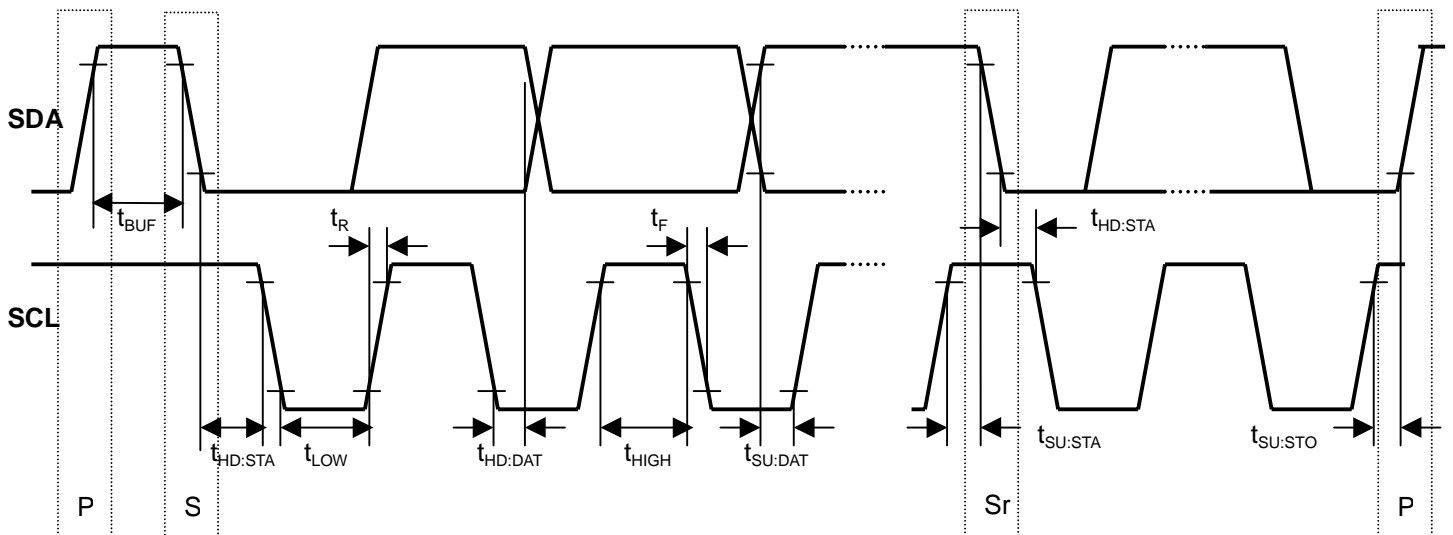

## ■ DEFINITION OF I<sup>2</sup>C REGISTER

### ● I<sup>2</sup>C BUS FORMAT

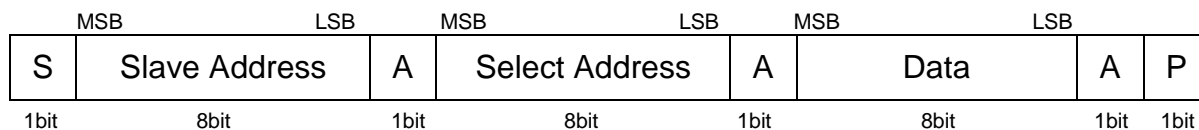

S: Starting Term  
 A: Acknowledge Bit  
 P: Ending Term

### ● SLAVE ADDRESS

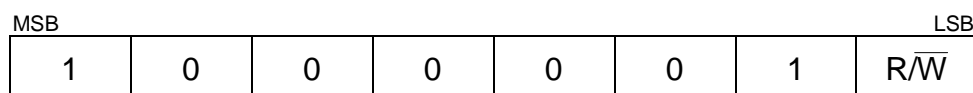

R/W=0: Receive Only  
 R/W=1: No Output Data

### ● CONTROL REGISTER TABLE

The select address sets each function (Volume, Balance, AGC, Surround, Tone Control, BBE, AUX).  
 The auto increment function cycles the select address as follows.  
 00H → 01H → 02H → 03H → 04H → 05H → 00H

Select Address	BIT							
	D7	D6	D5	D4	D3	D2	D1	D0
00H	VOL							
01H	CHS	BAL					AGC	SUR
02H	BCB	BASS			BCSB	SUB-BASS		
03H	BCT	TREB			BCST	SUB-TREB		
04H	BBE-Low				BBE-High			
05H	OUT	Don't care					AUX1	AUX0

### ● CONTROL REGISTER DEFAULT VALUE

Control register default value is all "0".

Select Address	BIT							
	D7	D6	D5	D4	D3	D2	D1	D0
00H	0	0	0	0	0	0	0	0
01H	0	0	0	0	0	0	0	0
02H	0	0	0	0	0	0	0	0
03H	0	0	0	0	0	0	0	0
04H	0	0	0	0	0	0	0	0
05H	0	0	0	0	0	0	0	0

Send the I2C BUS data after 30msec from turn on.

## ■INSTRUCTION CODE

### a) MASTER VOLUME SETTING

Select Address	BIT							
	D7	D6	D5	D4	D3	D2	D1	D0
00H	VOL							

The volume control for both Ach and Bch(0.33dB/step).

The volume is consisted of volume1 and volume2 and the level is divided into half to each volume1 and volume2.

### b) BALANCE, AGC AND SURROUND SETTING

Select Address	BIT							
	D7	D6	D5	D4	D3	D2	D1	D0
01H	CHS	BAL					AGC	SUR

- CHS : Channel select for balance control

“0” : Ach “Bch is attenuated”

“1” : Bch “Ach is attenuated”

- BAL : Balance control for both Ach and Bch(1dB/Step)

The balance is consisted of volume1 and volume2 and the level is divided into half to each volume1 and volume2.

- AGC : AGC switch

“0” : AGC OFF

“1” : AGC ON

- SUR : Surround mode switch

“0” : Surround OFF

“1” : Surround ON

### c)TONE CONTROL BASS SETTING

Select Address	BIT							
	D7	D6	D5	D4	D3	D2	D1	D0
02H	BCB	BASS					BCSB	SUB-BASS

- BCB : Boost cut select for Bass control

“0” : Cut

“1” : Boost

- BASS: BASS control(1dB/Step)

- BCSB : Boost cut select for SUB-BASS control

“0” : Cut

“1” : Boost

- SUB-BASS: SUB- BASS control(1dB/Step)



### d) TONE CONTROL TREBLE SETTING

Select Address	BIT							
	D7	D6	D5	D4	D3	D2	D1	D0
03H	BCT	TREB				BCST	SUB-TREB	

- BCT : Boost cut select for Treble control  
   "0" : Cut  
   "1" : Boost
- TREB: Treble control(1dB/step)
- BCST : Boost cut select for Sub-Treble control  
   "0" : Cut  
   "1" : Boost
- SUB-TREB: Sub-Treble control(1dB/step)

### e) BBE Boost Level Setting

Select Address	BIT							
	D7	D6	D5	D4	D3	D2	D1	D0
04H	BBE-Low				BBE-High			

- BBE-Low : Boost level control for BBE Lo-Countour(1dB/step)
- BBE-High : Boost level control for BBE Process(1dB/step)

When all bits are "0"(=00H), BBE becomes off

### f) OUTPUT AND AUXILIARY SETTING

Select Address	BIT							
	D7	D6	D5	D4	D3	D2	D1	D0
05H	OUT	Don't Care				AUX1	AUX0	

- OUT: ON/OFF Switch for OUTPUT  
   "0" : OFF  
   "1" : ON
- AUX1/AUX2: Auxiliary port High/Low  
   "0" : Logic output "Low"  
   "1" : Logic output "High"

# NJW1132A

## ■MASTER VOLUME (Select Address : 00H)

Gain (dB)	HEX	VOL							
		D7	D6	D5	D4	D3	D2	D1	D0
0	FF	1	1	1	1	1	1	1	1
-1	FC	1	1	1	1	1	1	0	0
-2	F9	1	1	1	1	1	0	0	1
-3	F6	1	1	1	1	0	1	1	0
-4	F3	1	1	1	1	0	0	1	1
-5	F0	1	1	1	1	0	0	0	0
-6	ED	1	1	1	0	1	1	0	1
-7	EA	1	1	1	0	1	0	1	0
-8	E7	1	1	1	0	0	1	1	1
-9	E4	1	1	1	0	0	1	0	0
-10	E1	1	1	1	0	0	0	0	1
-11	DE	1	1	0	1	1	1	1	0
-12	DB	1	1	0	1	1	0	1	1
-13	D8	1	1	0	1	1	0	0	0
-14	D5	1	1	0	1	0	1	0	1
-15	D2	1	1	0	1	0	0	1	0
-16	CF	1	1	0	0	1	1	1	1
-17	CC	1	1	0	0	1	1	0	0
-18	C9	1	1	0	0	1	0	0	1
-19	C6	1	1	0	0	0	1	1	0
-20	C3	1	1	0	0	0	0	1	1
-21	C0	1	1	0	0	0	0	0	0
-22	BD	1	0	1	1	1	1	0	1
-23	BA	1	0	1	1	1	0	1	0
-24	B7	1	0	1	1	0	1	1	1
-25	B4	1	0	1	1	0	1	0	0
-26	B1	1	0	1	1	0	0	0	1
-27	AE	1	0	1	0	1	1	1	0
-28	AB	1	0	1	0	1	0	1	1
-29	A8	1	0	1	0	1	0	0	0
-30	A5	1	0	1	0	0	1	0	1
-31	A2	1	0	1	0	0	0	1	0
-32	9F	1	0	0	1	1	1	1	1
-33	9C	1	0	0	1	1	1	0	0
-34	99	1	0	0	1	1	0	0	1
-35	96	1	0	0	1	0	1	1	0
-36	93	1	0	0	1	0	0	1	1
-37	90	1	0	0	1	0	0	0	0
-38	8D	1	0	0	0	1	1	0	1
-39	8A	1	0	0	0	1	0	1	0
-40	87	1	0	0	0	0	1	1	1
-41	84	1	0	0	0	0	1	0	0
-42	81	1	0	0	0	0	0	0	1

		VOL							
Gain (dB)	HEX	D7	D6	D5	D4	D3	D2	D1	D0
-43	7E	0	1	1	1	1	1	1	0
-44	7B	0	1	1	1	1	0	1	1
-45	78	0	1	1	1	1	0	0	0
-46	75	0	1	1	1	0	1	0	1
-47	72	0	1	1	1	0	0	1	0
-48	6F	0	1	1	0	1	1	1	1
-49	6C	0	1	1	0	1	1	0	0
-50	69	0	1	1	0	1	0	0	1
-51	66	0	1	1	0	0	1	1	0
-52	63	0	1	1	0	0	0	1	1
-53	60	0	1	1	0	0	0	0	0
-54	5D	0	1	0	1	1	1	0	1
-55	5A	0	1	0	1	1	0	1	0
-56	57	0	1	0	1	0	1	1	1
-57	54	0	1	0	1	0	1	0	0
-58	51	0	1	0	1	0	0	0	1
-59	4E	0	1	0	0	1	1	1	0
-60	4B	0	1	0	0	1	0	1	1
-61	48	0	1	0	0	1	0	0	0
-62	45	0	1	0	0	0	1	0	1
-63	42	0	1	0	0	0	0	1	0
-64	3F	0	0	1	1	1	1	1	1
-65	3C	0	0	1	1	1	1	0	0
-66	39	0	0	1	1	1	0	0	1
-67	36	0	0	1	1	0	1	1	0
-68	33	0	0	1	1	0	0	1	1
-69	30	0	0	1	1	0	0	0	0
-70	2D	0	0	1	0	1	1	0	1
-71	2A	0	0	1	0	1	0	1	0
-72	27	0	0	1	0	0	1	1	1
-73	24	0	0	1	0	0	1	0	0
-74	21	0	0	1	0	0	0	0	1
-75	1E	0	0	0	1	1	1	1	0
-76	1B	0	0	0	1	1	0	1	1
-77	18	0	0	0	1	1	0	0	0
-78	15	0	0	0	1	0	1	0	1
-79	12	0	0	0	1	0	0	1	0
-80	0F	0	0	0	0	1	1	1	1
-81	0C	0	0	0	0	1	1	0	0
-82	09	0	0	0	0	1	0	0	1
-83	06	0	0	0	0	0	1	1	0
-84	03	0	0	0	0	0	0	1	1
Mute	00	0	0	0	0	0	0	0	0

■BALANCE (Select Address : 01H)

Channel Select (CHS)	D7
Ach	0
Bch	1

Gain(dB)	BAL				
	D6	D5	D4	D3	D2
0	0	0	0	0	0
-1	0	0	0	0	1
-2	0	0	0	1	0
-3	0	0	0	1	1
-4	0	0	1	0	0
-5	0	0	1	0	1
-6	0	0	1	1	0
-7	0	0	1	1	1
-8	0	1	0	0	0
-9	0	1	0	0	1
-10	0	1	0	1	0
-11	0	1	0	1	1
-12	0	1	1	0	0
-13	0	1	1	0	1
-14	0	1	1	1	0
-15	0	1	1	1	1
-16	1	0	0	0	0
-17	1	0	0	0	1
-18	1	0	0	1	0
-19	1	0	0	1	1
-20	1	0	1	0	0
-21	1	0	1	0	1
-22	1	0	1	1	0
-23	1	0	1	1	1
-24	1	1	0	0	0
-25	1	1	0	0	1
-26	1	1	0	1	0
-27	1	1	0	1	1
-28	1	1	1	0	0
-29	1	1	1	0	1
-30	1	1	1	1	0
Mute	1	1	1	1	1

■TONE CONTROL BASS (Select Address : 02H)

	BCB
<b>Bass Cut or Boost</b>	<b>D7</b>
Cut	0
Boost	1

		BASS			
Cut Gain(dB)	Boost Gain(dB)	D6	D5	D4	D3
-15	15	1	1	1	1
-14	14	1	1	1	0
-13	13	1	1	0	1
-12	12	1	1	0	0
-11	11	1	0	1	1
-10	10	1	0	1	0
-9	9	1	0	0	1
-8	8	1	0	0	0
-7	7	0	1	1	1
-6	6	0	1	1	0
-5	5	0	1	0	1
-4	4	0	1	0	0
-3	3	0	0	1	1
-2	2	0	0	1	0
-1	1	0	0	0	1
0	0	0	0	0	0

■TONE CONTROL SUB-BASS (Select Address : 02H)

	BCSB
<b>Sub-Bass Cut or Boost</b>	<b>D2</b>
Cut	0
Boost	1

		SUB-BASS	
Cut Gain(dB)	Boost Gain(dB)	D1	D0
-3	3	1	1
-2	2	1	0
-1	1	0	1
0	0	0	0

## ■TONE CONTROL TREBLE (Select Address : 03H)

	BCT
<b>Treble Cut or Boost</b>	<b>D7</b>
Cut	0
Boost	1

		TREB			
Cut Gain(dB)	Boost Gain(dB)	D6	D5	D4	D3
-15	15	1	1	1	1
-14	14	1	1	1	0
-13	13	1	1	0	1
-12	12	1	1	0	0
-11	11	1	0	1	1
-10	10	1	0	1	0
-9	9	1	0	0	1
-8	8	1	0	0	0
-7	7	0	1	1	1
-6	6	0	1	1	0
-5	5	0	1	0	1
-4	4	0	1	0	0
-3	3	0	0	1	1
-2	2	0	0	1	0
-1	1	0	0	0	1
0	0	0	0	0	0

## ■TONE CONTROL SUB-TREBLE (Select Address : 03H)

	BCST
<b>Sub-Treble Cut or Boost</b>	<b>D2</b>
Cut	0
Boost	1

		SUB-TREB	
Cut Gain(dB)	Boost Gain(dB)	D1	D0
-3	3	1	1
-2	2	1	0
-1	1	0	1
0	0	0	0

■BBE Low(Lo Contour) / High(Process) Gain Code

Gain(dB)	BBE-Low(Lo Contour)				BBE-High(Process)			
	D7	D6	D5	D4	D3	D2	D1	D0
15	1	1	1	1	1	1	1	1
14	1	1	1	0	1	1	1	0
13	1	1	0	1	1	1	0	1
12	1	1	0	0	1	1	0	0
11	1	0	1	1	1	0	1	1
10	1	0	1	0	1	0	1	0
9	1	0	0	1	1	0	0	1
8	1	0	0	0	1	0	0	0
7	0	1	1	1	0	1	1	1
6	0	1	1	0	0	1	1	0
5	0	1	0	1	0	1	0	1
4	0	1	0	0	0	1	0	0
3	0	0	1	1	0	0	1	1
2	0	0	1	0	0	0	1	0
1	0	0	0	1	0	0	0	1
0	0	0	0	0	0	0	0	0

## ■TERMINAL DESCRIPTION

No.	SYMBOL	FUNCTION	EQUIVALENT CIRCUIT	VOLTAGE
1 30	INa,INb	Input Pin		VCC/2
2 3 28 29	BBE1a BBE2a BBE2b BBE1b	Ach BBE Filter (Process) Ach BBE Filter (Lo Countour) Bch BBE Filter (Lo Countour) Bch BBE Filter (Process)		VCC/2
4 27	BBE OUTa BBE OUTb	Output for the Other Accessories		VCC/2
5 26	TONE INa TONE INb	Input from the Other Accessories		VCC/2



## ■ TERMINAL DESCRIPTION

No.	SYMBOL	FUNCTION	EQUIVALENT CIRCUIT	VOLTAGE
6 25	TONE-Ha TONE-Hb	A/Bch Treble Filter		VCC/2
7 24	TONE-La TONE-Lb	A/Bch Bass Filter		VCC/2
8 23	OUTa OUTb	Output Pin		VCC/2
9	AGC1	AGC1		0.7V

# NJW1132A

## ■TERMINAL DESCRIPTION

No.	SYMBOL	FUNCTION	EQUIVALENT CIRCUIT	VOLTAGE
10	AGC2	AGC2		VCC/2
11 12	CVB CVA	DAC Output for A/Bch Volume & Balance		1.4V
13 14	SDA SCL	SDA Data Input (I2C BUS) SCL Data Input (I2C BUS)		-
15	GND	GND Pin		-
16	VCC	Voltage Supply Pin		-

## ■ TERMINAL DESCRIPTION

No.	SYMBOL	FUNCTION	EQUIVALENT CIRCUIT	VOLTAGE
17 18	AUX1 AUX0	Auxiliary Output		5V 0V
19 20	CTL CTH	DAC Output for Tone Low Frequency DAC Output for Tone High Frequency		1.4V
21	VREF	Reference Voltage		VCC/2
22	PS	Surround Phase Shift Filter		VCC/2

## ■ TYPICAL CHARACTERISTICS

**Operating Current vs Operating Voltage**  
No Signal

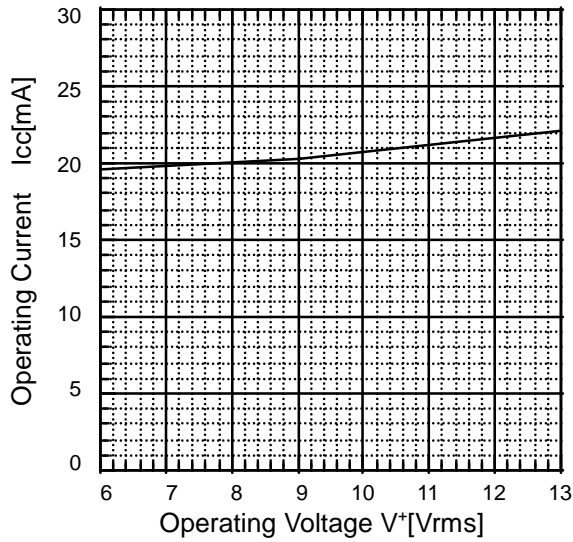

**Total Harmonic Distortion vs. Input Voltage**  
f=1kHz

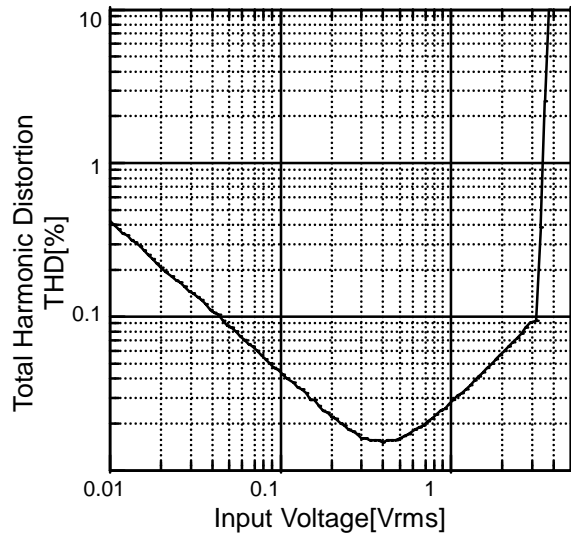

**Cross Talk**  
Vin = 6dBV (2Vrms)

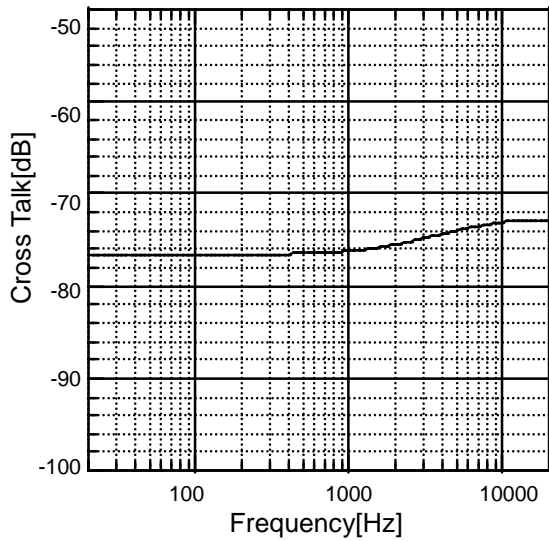

**Channel Separation**  
Vin = +6dBV (2Vrms)

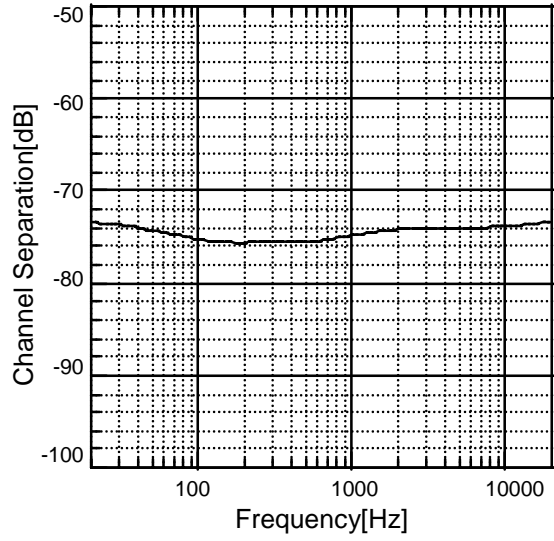

**AGC**

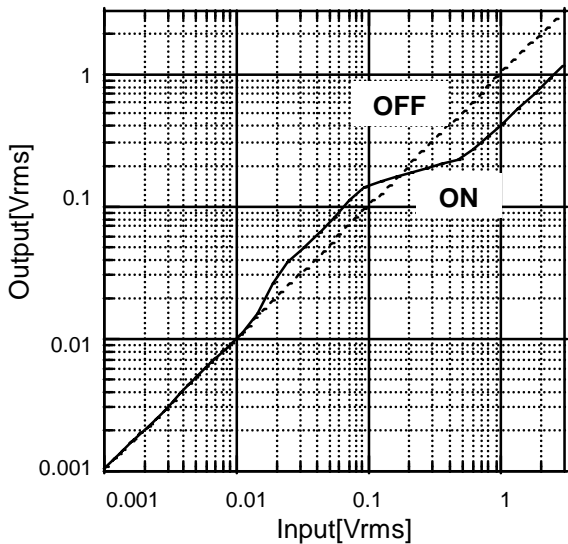

**Balance Control**  
Vin = 1Vrms/1kHz

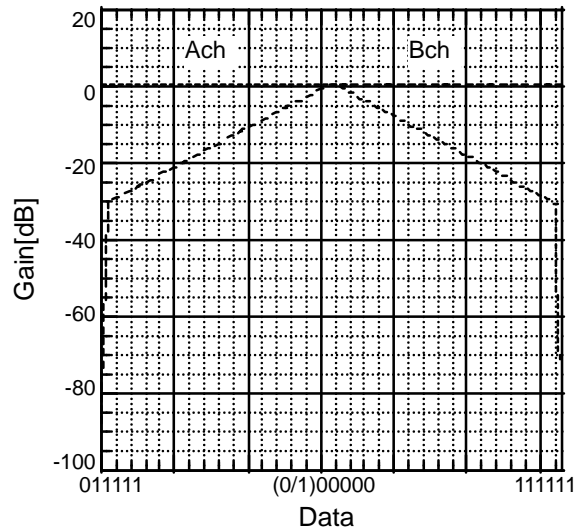

**Master Volume**

Vin = 1Vrms / 1kHz

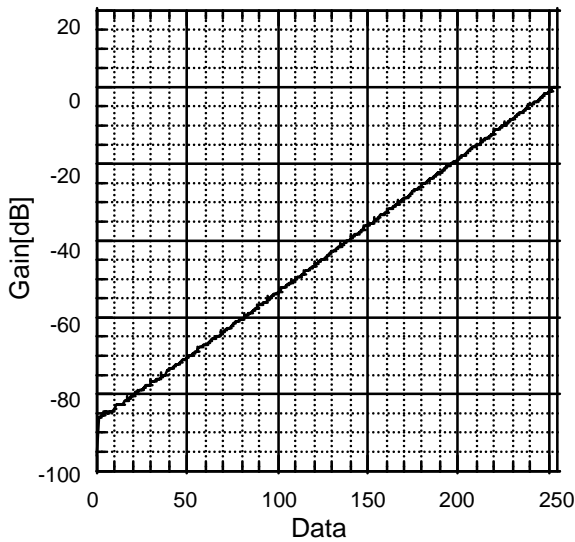

**Tone Control**

Vin = 100mVrms

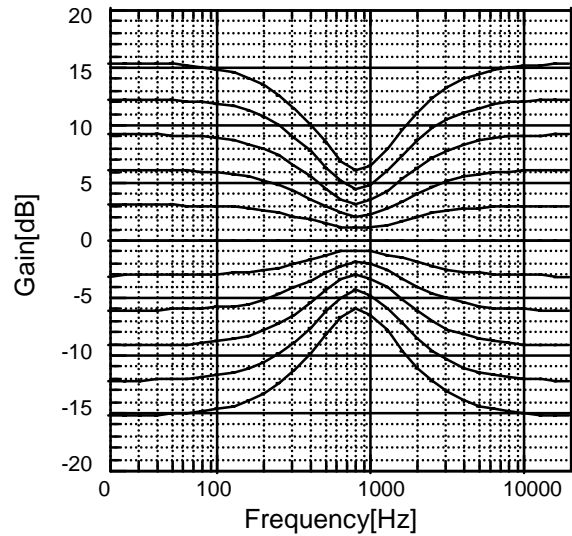

**BBE Response**

Vin = 1Vrms / 1kHz

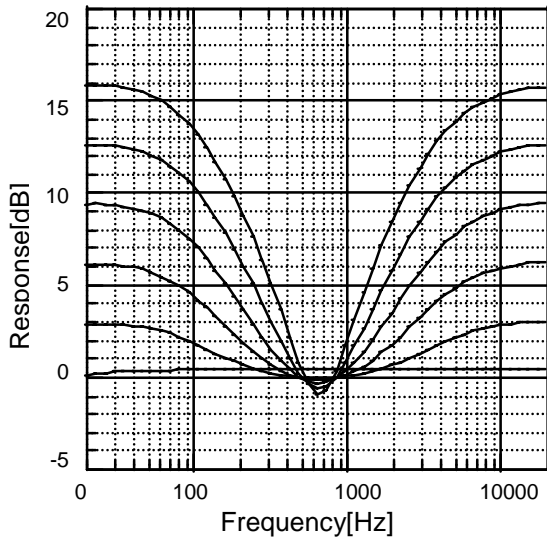

**BBE Phase**

+6dB Boost

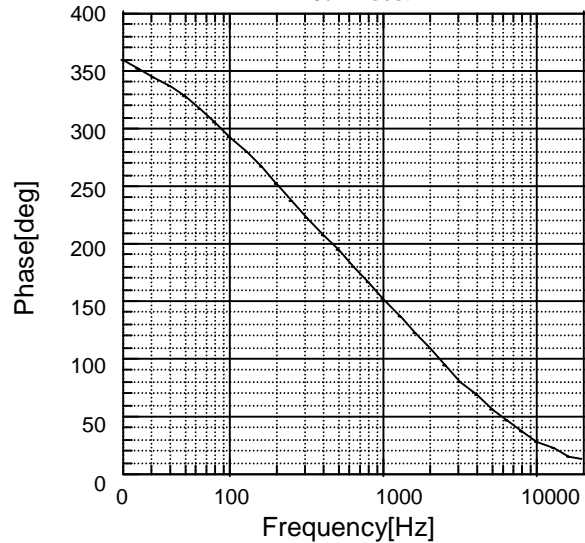

**NOTE**

The **NJW1132A** is manufactured by New Japan Radio Co., Ltd. under license from BBE Sound Inc. BBE is a registered trademark of BBE Sound Inc.

A license from BBE Sound Inc. is required before the **NJW1132A** can be purchased from New Japan Radio Co., Ltd.

Purchase of I<sup>2</sup>C components of New Japan Radio Co., Ltd or one of its sublicensed Associated Companies conveys a license under the Philips I<sup>2</sup>C Patent Rights to use these components in an I<sup>2</sup>C system, provided that the system conforms to the I<sup>2</sup>C Standard Specification as defined by Philips.

BBE Sound, Inc.  
 5381 Production Drive  
 Huntington Beach, CA 92649  
 Tel:(714)897-6766  
 Fax:(714)896-0736

[CAUTION]  
 The specifications on this databook are only given for information, without any guarantee as regards either mistakes or omissions. The application circuits in this databook are described only to show representative usages of the product and not intended for the guarantee or permission of any right including the industrial rights.

SUNSTAR 商斯达实业集团是集研发、生产、工程、销售、代理经销、技术咨询、信息服务等为一体的高科技企业，是专业高科技电子产品生产厂家，是具有 10 多年历史的专业电子元器件供应商，是中国最早和最大的仓储式连锁规模经营大型综合电子零部件代理分销商之一，是一家专业代理和分销世界各大品牌 IC 芯片和电子元器件的连锁经营综合性国际公司，专业经营进口、国产名厂名牌电子元件，型号、种类齐全。在香港、北京、深圳、上海、西安、成都等全国主要电子市场设有直属分公司和产品展示展销窗口门市部专卖店及代理分销商，已在全国范围内建成强大统一的供货和代理分销网络。我们专业代理经销、开发生产电子元器件、集成电路、传感器、微波光电元器件、工控机/DOC/DOM 电子盘、专用电路、单片机开发、MCU/DSP/ARM/FPGA 软件硬件、二极管、三极管、模块等，是您可靠的一站式现货配套供应商、方案提供商、部件功能模块开发配套商。商斯达实业公司拥有庞大的资料库，有数位毕业于著名高校——有中国电子工业摇篮之称的西安电子科技大学（西军电）并长期从事国防尖端科技研究的高级工程师为您精挑细选、量身订做各种高科技电子元器件，并解决各种技术问题。

微波光电部专业代理经销高频、微波、光纤、光电元器件、组件、部件、模块、整机；电磁兼容元器件、材料、设备；微波 CAD、EDA 软件、开发测试仿真工具；微波、光纤仪器仪表。欢迎国外高科技微波、光纤厂商将优秀产品介绍到中国、共同开拓市场。长期大量现货专业批发高频、微波、卫星、光纤、电视、CATV 器件：晶振、VCO、连接器、PIN 开关、变容二极管、开关二极管、低噪晶体管、功率电阻及电容、放大器、功率管、MMIC、混频器、耦合器、功分器、振荡器、合成器、衰减器、滤波器、隔离器、环行器、移相器、调制解调器；光电子元件和组件：红外发射管、红外接收管、光电开关、光敏管、发光二极管和发光二极管组件、半导体激光二极管和激光器组件、光电探测器和光接收组件、光发射接收模块、光纤激光器和光放大器、光调制器、光开关、DWDM 用光发射和接收器件、用户接入系统光收发器件与模块、光纤连接器、光纤跳线/尾纤、光衰减器、光纤适配器、光隔离器、光耦合器、光环行器、光复用器/转换器；无线收发芯片和模组、蓝牙芯片和模组。

更多产品请看本公司产品专用销售网站：

商斯达中国传感器科技信息网：<http://www.sensor-ic.com/>

商斯达工控安防网：<http://www.pc-ps.net/>

商斯达电子元器件网：<http://www.sunstare.com/>

商斯达微波光电产品网：[HTTP://www.rfoe.net/](http://www.rfoe.net/)

商斯达消费电子产品网：<http://www.icasic.com/>

商斯达实业科技产品网：<http://www.sunstars.cn/> 微波元器件销售热线：

地址：深圳市福田区福华路福庆街鸿图大厦 1602 室

电话：0755-82884100 83397033 83396822 83398585

传真：0755-83376182 (0) 13823648918 MSN: SUNS8888@hotmail.com

邮编：518033 E-mail:[szss20@163.com](mailto:szss20@163.com) QQ: 195847376

深圳赛格展销部：深圳华强北路赛格电子市场 2583 号 电话：0755-83665529 25059422

技术支持：0755-83394033 13501568376

欢迎索取免费详细资料、设计指南和光盘；产品凡多，未能尽录，欢迎来电查询。

北京分公司：北京海淀区知春路 132 号中发电子大厦 3097 号

TEL: 010-81159046 82615020 13501189838 FAX: 010-62543996

上海分公司：上海市北京东路 668 号上海赛格电子市场 D125 号

TEL: 021-28311762 56703037 13701955389 FAX: 021-56703037

西安分公司：西安高新开发区 20 所(中国电子科技集团导航技术研究所)

西安劳动南路 88 号电子商城二楼 D23 号

TEL: 029-81022619 13072977981 FAX:029-88789382