



Audio Processor with Sound Enhancement and TruSurround Virtualizer

GENERAL DESCRIPTION

The NJW1148 is an audio processor with BBE sound enhancement and SRS Labs' TruSurround virtualizer. It includes all of functions processing audio signal for TV, such as volume, balance, mute, line out, tone control, eala NJRC surround and simulated stereo functions. All of internal status and variables are controlled by I²C BUS.

PACKAGE OUTLINE

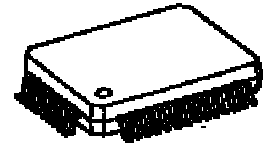

NJW1148FP1

FEATURES

- Operating Voltage 8 to 10 V
- I²C BUS Interface (Fast-Mode)
- Passive TruSurround
- BBE 0dB to +15dB(0.5dB/step)
- eala (surround effect ; 2 steps) and Simulated Stereo
- Volume 0 to -80dB, MUTE(0.33dB/step)
- Balance 0 to -30dB, MUTE(1dB/step)
- Tone Control -15dB to +15dB(0.5dB/step)
- Bi-CMOS Technology
- Package Outline QFP48-P1

BLOCK DIAGRAM

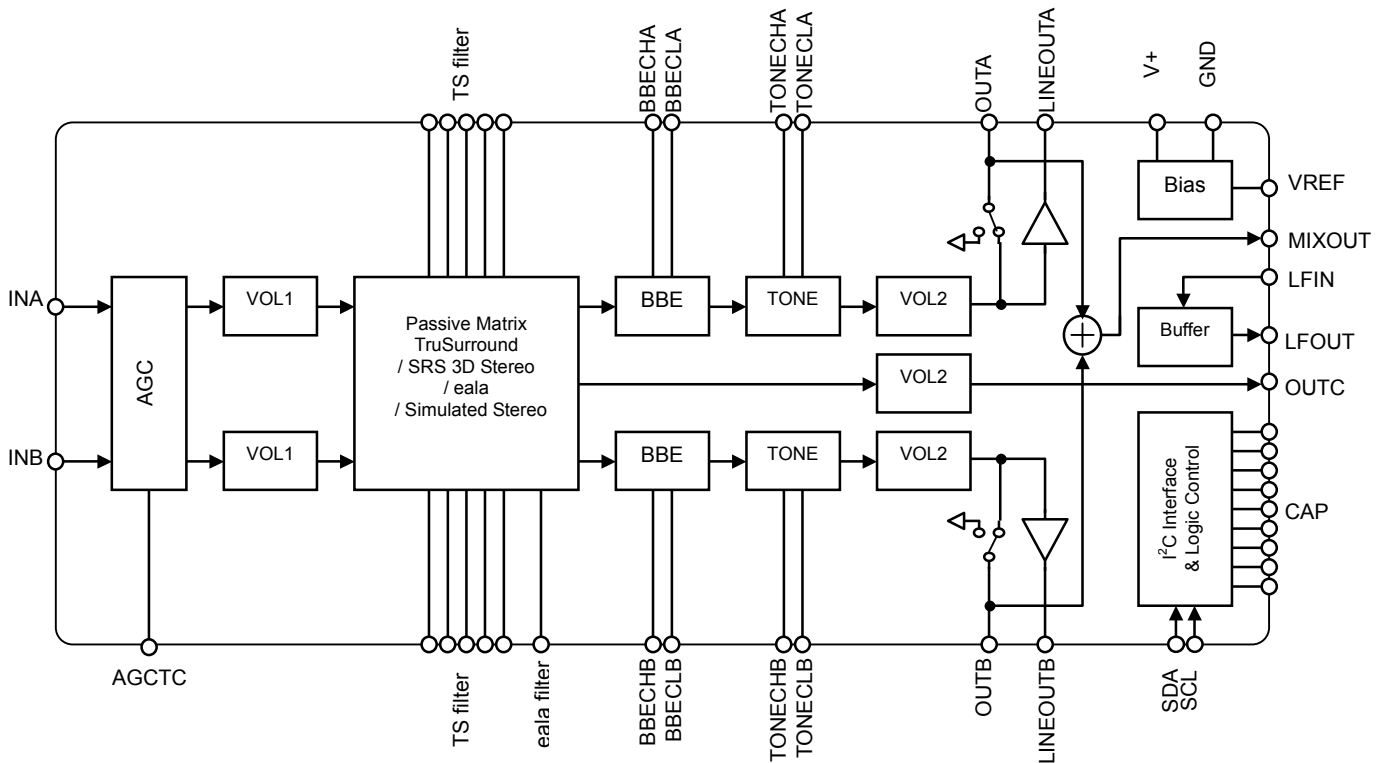

■ PIN FUNCTION

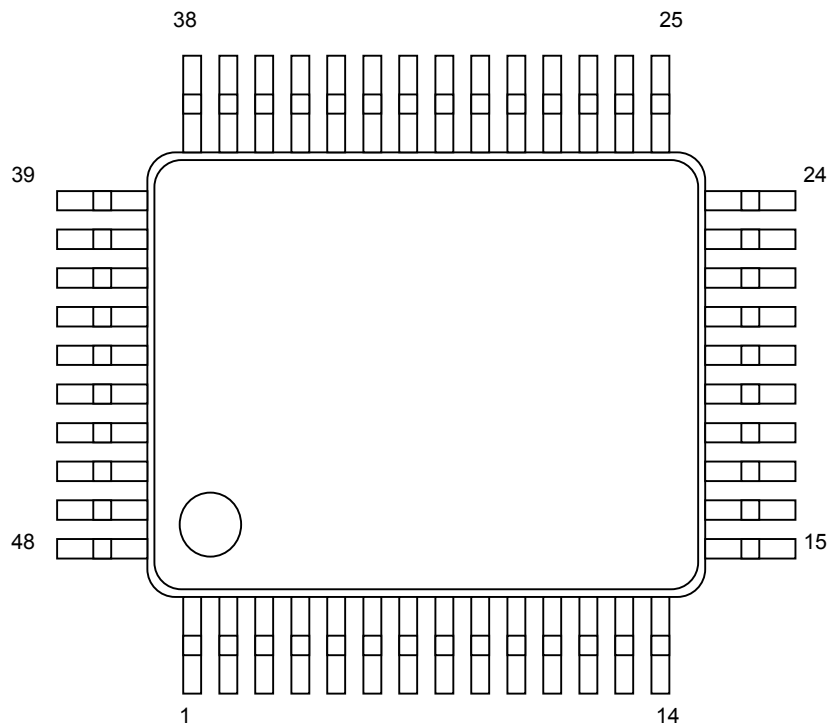

| No. | SYMBOL | FUNCTION | No. | SYMBOL | FUNCTION |
|-----|----------|---|-----|----------|--|
| 1 | TS3 | TruSurround Filter Capacitor 3 | 25 | BBELTC | BBE Low switching noise rejection Capacitor |
| 2 | INA | Ach Input | 26 | BBEHTC | BBE High switching noise rejection Capacitor |
| 3 | BBECHA | Ach BBE High-Pass Filter Capacitor | 27 | N.C. | No Connection |
| 4 | BBECLA | Ach BBE Low-Pass Filter Capacitor | 28 | LFOUT | Buffer Output for LPF |
| 5 | TONECHA | Ach TONE Treble Filter Capacitor | 29 | LFIN | Buffer Input for LPF |
| 6 | TONECLA | Ach TONE Bass Filter Capacitor | 30 | MIXOUT | Ach Bch Mixed Output |
| 7 | LINEOUTA | Ach Line Output | 31 | OUTB | Bch Output |
| 8 | OUTA | Ach Output | 32 | LINEOUTB | Bch Line Output |
| 9 | OUTC | Center Output | 33 | TONECLB | Bch TONE Bass Filter Capacitor |
| 10 | N.C. | No Connection | 34 | TONECHB | Bch TONE Treble Filter Capacitor |
| 11 | AGCTC | AGC Smoothing Filter Capacitor | 35 | BBECLB | Bch BBE Low-Pass Filter Capacitor |
| 12 | SURTC | Surround switching noise rejection Capacitor | 36 | BBECHB | Bch BBE High-Pass Filter Capacitor |
| 13 | VOLATC | Ach Volume switching noise rejection Capacitor | 37 | INB | Bch Input |
| 14 | VOLBTC | Bch Volume switching noise rejection Capacitor | 38 | SRS4 | SRS Filter Capacitor 4 |
| 15 | VOLCTC | Center Volume switching noise rejection Capacitor | 39 | SRS3 | SRS Filter Capacitor 3 |
| 16 | SDA | I ² C Data Input | 40 | SRS2 | SRS Filter Capacitor 2 |
| 17 | SCL | I ² C Clock Input | 41 | SRS1 | SRS Filter Capacitor 1 |
| 18 | GND | Ground | 42 | SPACE1 | SPACE Volume1 |
| 19 | N.C. | No Connection | 43 | CENTER | CENTER Volume |
| 20 | V+ | Power Supply | 44 | N.C. | No Connection |
| 21 | VREF | Reference Voltage stabilizing Capacitor | 45 | SPACE2 | SPACE Volume2 |
| 22 | TONEHTC | Tone Control Treble switching noise rejection Capacitor | 46 | CEALA | eala Filter Capacitor |
| 23 | TONELTC | Tone Control Bass switching noise rejection Capacitor | 47 | TS1 | TruSurround Filter Capacitor 1 |
| 24 | OUTTC | Line Output switching noise rejection Capacitor | 48 | TS2 | TruSurround Filter Capacitor 2 |

■ ABSOLUTE MAXIMUM RATING (Ta=25°C)

| PARAMETER | SYMBOL | RATING | UNIT |
|-----------------------------|----------------|---------------------------------|------|
| Supply Voltage | V ⁺ | 12 | V |
| Power Dissipation | P _D | 1500 (*JEDEC2 layers PCB mount) | mW |
| Operating Temperature Range | Topr | -20 to +75 | °C |
| Storage Temperature Range | Tstg | -40 to +125 | °C |

**■ ELECTRICAL CHARACTERISTICS (Ta=25°C, V⁺=9V, R_L=47kΩ, Vin=100mVrms/1kHz
MODE ; VOL=0dB, BAL=0dB, SUR=OFF, AGC=OFF, BBE=OFF, Tone=0dB)**

| PARAMETER | SYMBOL | TEST CONDITION | MIN. | TYP. | MAX. | UNIT |
|---------------------------|--------------------|--|------|---------------|---------------|----------------|
| Operating Voltage | V ⁺ | | 8.0 | 9.0 | 10.0 | V |
| Supply Current | I _{CC} | No Signal | - | 30 | 45 | mA |
| Reference Voltage | V _{REF} | No Signal | 4.0 | 4.5 | 5.0 | V |
| Maximum Input Voltage | V _{IM} | VOL=-20dB, THD=10% | 2.8 | 3.0 | - | Vrms |
| Maximum Output Voltage | V _{OM} | OUTPUT VOL=0dB, THD=1% | - | 2.5 | - | Vrms |
| Channel Balance | G _{CB} | VOL=0dB | -1.5 | 0.0 | 1.5 | dB |
| Balance Boost A | G _{BBA} | CHS="0", BAL=Mute Vin = 1Vrms | -2.0 | 0.0 | 2.0 | dB |
| Balance Cut A | G _{BCA} | CHS="1", BAL=Mute Vin = 1Vrms | - | - | -70 | dB |
| Balance Boost B | G _{BBB} | CHS="1", BAL=Mute Vin = 1Vrms | -2.0 | 0.0 | 2.0 | dB |
| Balance Cut B | G _{BCB} | CHS="0", BAL=Mute Vin = 1Vrms | - | - | -70 | dB |
| Total Harmonic Distortion | THD | Vo=0.5Vrms BW=400Hz to 30kHz | - | - | 0.5 | % |
| Maximum Voltage Gain | G _{VMAX} | VOL= 0dB | -2.0 | 0.0 | 2.0 | dB |
| Minimum Voltage Gain | G _{VMIN} | VOL= Mute | - | - | -70 | dB |
| MIX Output Voltage Gain | G _{VMIX} | MIXOUT, VOL=0dB | -2.0 | 0.0 | 2.0 | dB |
| Line Output Voltage Gain | G _{VLINE} | LINEOUT, VOL=0dB | 2.5 | 4.5 | 6.5 | dB |
| Channel Separation | CS | Vin = 1Vrms | - | - | -70 | dB |
| Output Noise 1 | V _{NO1} | VOL = 0dB BW=400Hz to 30kHz | - | -90 (31.6) | -85 (56.2) | dBV (μVrms) |
| Output Noise 2 | V _{NO2} | VOL = Mute BW = 400Hz to 30kHz | - | -106 (5.0) | -96 (15.8) | dBV (μVrms) |
| Output Noise 3 | V _{NO3} | LINEOUT, VOL = 0dB BW=400Hz to 30kHz | - | -85 (56.2) | -80 (100) | dBV (μVrms) |
| Output Noise 4 | V _{NO4} | LINEOUT, VOL = Mute BW = 400Hz to 30kHz | - | -101 (8.9) | -91 (28.2) | dBV (μVrms) |

BW : Band Width

**◆TONE CONTROL CHARACTERISTICS (Ta=25°C, V⁺=9V, R_L=47kΩ, Vin=100mVrms/1kHz
MODE ; VOL=0dB, BAL=0dB, SUR=OFF, AGC=OFF, BBE=OFF)**

| PARAMETER | SYMBOL | TEST CONDITION | MIN. | TYP. | MAX. | UNIT |
|-------------------|---------------------|---------------------|-------|-------|-------|------|
| Treble Boost Gain | G _{HFBST} | TREB=+15dB, f=10kHz | 12.5 | 15.0 | 17.5 | dB |
| Treble Boost Flat | G _{HFFLT} | TREB=0dB, f=10kHz | -2.0 | 0.0 | 2.0 | dB |
| Treble Boost Cut | G _{HFCUT} | TRBE=-15dB, f=10kHz | -17.5 | -15.0 | -12.5 | dB |
| Bass Boost Gain | G _{LFBST} | BASS=+15dB, f=100Hz | 12.5 | 15.0 | 17.5 | dB |
| Bass Boost Flat | G _{LFFLT} | BASS=0dB, f=100Hz | -2.0 | 0.0 | 2.0 | dB |
| Bass Boost Cut | G _{LF CUT} | BASS=-15dB, f=100Hz | -17.5 | -15.0 | -12.5 | dB |

◆AGC CHARACTERISTICS (Ta=25°C, V⁺=9V, R_L=47kΩ
MODE ; VOL=0dB, BAL=0dB, SUR=OFF, AGC=ON, BBE=OFF, Tone=0dB)

| PARAMETER | SYMBOL | TEST CONDITION | MIN. | TYP. | MAX. | UNIT |
|------------|----------------------|----------------------|------|------|------|------|
| AGC Boost | G _{AGCBST} | Vin=50mVrms, f=1kHz | 1.5 | 3.5 | 5.5 | dB |
| AGC Flat 1 | G _{AGCFLT1} | Vin=300mVrms, f=1kHz | -2.5 | 0.0 | 2.5 | dB |
| AGC Flat 2 | G _{AGCFLT2} | Vin=400mVrms, f=1kHz | -2.5 | 0.0 | 2.5 | dB |
| AGC Flat 3 | G _{AGCFLT3} | Vin=500mVrms, f=1kHz | -2.5 | 0.0 | 2.5 | dB |
| AGC Flat 4 | G _{AGCFLT4} | Vin=600mVrms, f=1kHz | -2.5 | 0.0 | 2.5 | dB |
| AGC Cut | G _{AGCCUT} | Vin=2Vrms, f=1kHz | -14 | -10 | -6.0 | dB |

◆BBE CHARACTERISTICS (Ta=25°C, V⁺=9V, R_L=47kΩ, Vin=100mVrms/1kHz
MODE ; VOL=0dB, BAL=0dB, SUR=OFF, AGC=OFF, Tone=0dB)

| PARAMETER | SYMBOL | TEST CONDITION | MIN. | TYP. | MAX. | UNIT |
|-----------------|----------------------|------------------------|------|------|------|------|
| Low Boost Gain | G _{BBELOW} | BBE-LOW =+15dB, f=50Hz | 12.5 | 15 | 17.5 | dB |
| High Boost Gain | G _{BBEHIGH} | BBE-HIGH=+15dB,f=10kHz | 12.5 | 15 | 17.5 | dB |

◆eala CHARACTERISTICS (Ta=25°C, V⁺=9V, R_L=47kΩ, Vin=100mVrms/1kHz
MODE ; VOL=0dB, BAL=0dB, AGC=OFF, BBE=0dB, Tone=0dB)

| PARAMETER | SYMBOL | TEST CONDITION | MIN. | TYP. | MAX. | UNIT |
|--------------------|-------------------|----------------------------------|------|------|------|------|
| Simulated Stereo A | G _{SIMA} | LIN+RIN→OUTa, f=1KHz SUR=MONO | 1.0 | 3.0 | 5.0 | dB |
| Simulated Stereo B | G _{SIMB} | LIN+RIN→OUTb, f=1KHz SUR=MONO | 1.0 | 3.0 | 5.0 | dB |
| Surround 3D1 | G _{3D1} | LIN→OUTa, f=100Hz SUR=eala6 | 10 | 12 | 14 | dB |
| Surround 3D2 | G _{3D2} | LIN→OUTa, f=10KHz SUR=eala6 | -2.0 | 0.0 | 2.0 | dB |
| Surround 3D3 | G _{3D3} | LIN→OUTb, f=100Hz SUR=eala6 | 8 | 10 | 12 | dB |
| Surround 3D4 | G _{3D4} | LIN→OUTa, f=100Hz SUR=eala1 | 0 | 2 | 4 | dB |

◆TruSurround CHARACTERISTICS (Ta=25°C, V⁺=9V, R_L=47kΩ, Vin=100mVrms/1kHz
MODE; VOL=0dB, BAL=0dB, AGC=OFF, BBE=OFF, Tone=0dB)

| PARAMETER | SYMBOL | TEST CONDITION | MIN. | TYP. | MAX. | UNIT |
|-------------------|------------------|---------------------------------|-------|-------|------|------|
| TruSurround Gain1 | G _{TS1} | AIN→AOUT, f=1KHz SUR=TS | 0.3 | 2.3 | 4.3 | dB |
| TruSurround Gain2 | G _{TS2} | AIN→BOUT, f=1KHz SUR=TS | -13.4 | -11.4 | -9.4 | dB |
| TruSurround Gain3 | G _{TS3} | A+BIN→COUT, f=1KHz SUR=TS2.1 | -1.1 | 0.9 | 2.9 | dB |

◆SRS 3D CHARACTERISTICS (Ta=25°C, V⁺=9V, R_L=47kΩ, Vin=100mVrms/1kHz
MODE; VOL=0dB, BAL=0dB, AGC=OFF, BBE=OFF, Tone=0dB)

| PARAMETER | SYMBOL | TEST CONDITION | MIN. | TYP. | MAX. | UNIT |
|-------------------|----------------------|---------------------------------|-------|-------|-------|------|
| Feed Through Gain | G _{THROUGH} | AIN→AOUT, f=1KHz SUR=SRS 3D | -20.2 | -18.2 | -16.2 | dB |
| L+R Gain | G _{L+R} | AIN→AOUT, f=1KHz SUR=SRS 3D | -15.0 | -13.0 | -11.0 | dB |
| L-R Gain | G _{L-R} | AIN→AOUT, f=125Hz SUR=SRS 3D | -2.0 | 0.0 | 2.0 | dB |

■ I²C BUS CHARACTERISTICS (SDA, SCL)

I²C BUS Load Conditions: Pull up resistance 4kΩ (Connected to +5V), Load capacitance 200pF (Connected to GND)

| PARAMETER | SYMBOL | MIN. | TYP. | MAX. | UNIT |
|--|---------------------|----------------------|------|------|------|
| Low Level Input Voltage | V _{IL} | 0.0 | - | 1.5 | V |
| High Level Input Voltage | V _{IH} | 3.0 | - | 5.0 | V |
| Hysteresis of Schmitt trigger inputs | V _{hys} | 0.25 | - | - | V |
| LOW level output voltage (3mA at SDA pin) | V _{OL} | 0 | - | 0.4 | V |
| Output fall time from V _{IHmin} to V _{ILmax} with a bus capacitance from 10pF to 400pF | t _{of} | 20+0.1C _b | - | 250 | ns |
| Pulse width of spikes which must be suppressed by the input filter | t _{SP} | 0 | - | 50 | ns |
| Input current each I/O pin with an input voltage between 0.1V _{DD} and 0.9V _{DDmax} | I _i | -10 | - | 10 | μA |
| Capacitance for each I/O pin | C _i | - | - | 10 | pF |
| SCL clock frequency | f _{SCL} | - | - | 400 | kHz |
| Hold time (repeated) START condition. | t _{HD:STA} | 0.6 | - | - | μs |
| LOW period of the SCL clock | t _{LOW} | 1.3 | - | - | μs |
| HIGH period of the SCL clock | t _{HIGH} | 0.6 | - | - | μs |
| Set-up time for a repeated START condition | t _{SU:STA} | 0.6 | - | - | μs |
| Data hold time | t _{HD:DAT} | - | - | 0.9 | μs |
| Data set-up time | t _{SU:DAT} | 100 | - | - | ns |
| Rise time of both SDA and SCL signals | t _r | - | - | 300 | ns |
| Fall time of both SDA and SCL signals | t _f | - | - | 300 | ns |
| Set-up time for STOP condition | t _{SU:STO} | 0.6 | - | - | μs |
| Bus free time between a STOP and START condition | t _{BUF} | 1.3 | - | - | μs |
| Capacitive load for each bus line | C _b | - | - | 400 | pF |
| Noise margin at the LOW level | V _{nL} | 0.5 | - | - | V |
| Noise margin at the HIGH level | V _{nH} | 1 | - | - | V |

C_b ; total capacitance of one bus line in pF.

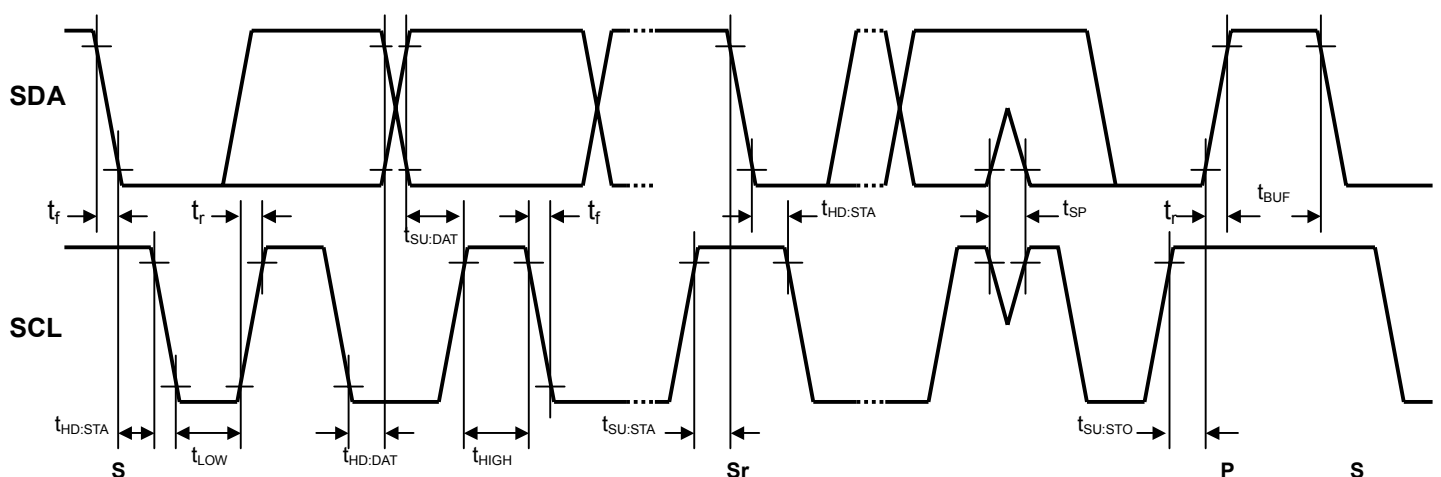

APPLICATION CIRCUIT

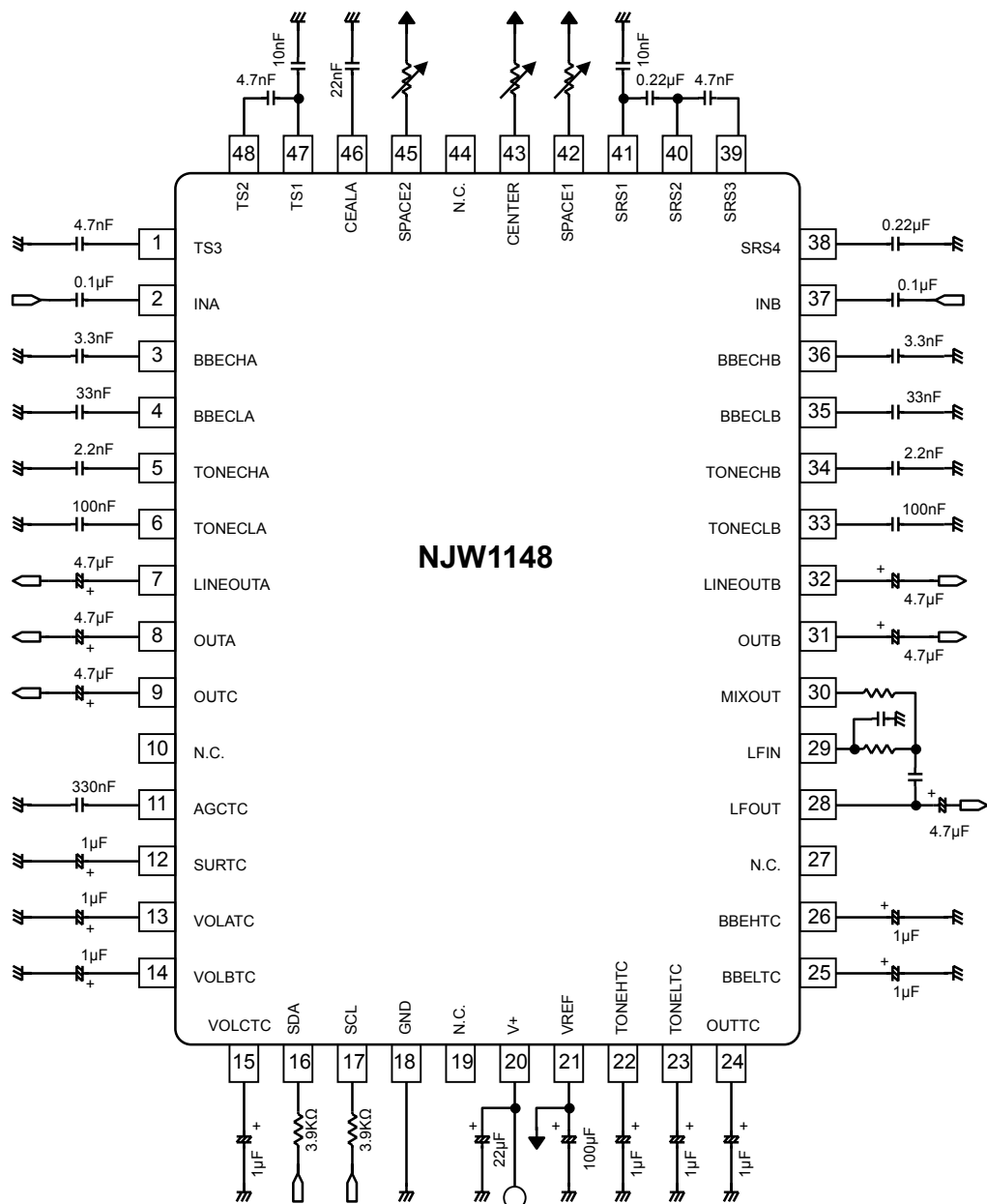

(NOTE)

1. Separate the I²C bus line from the following terminals for avoiding digital noise problem.

| Pin No. | Symbol | Pin No. | Symbol | Pin No. | Symbol | Pin No. | Symbol |
|---------|---------|---------|---------|---------|--------|---------|--------|
| 1 | TS3 | 6 | TONECLA | 36 | BBECHB | 41 | SRS1 |
| 3 | BBECHA | 33 | TONECLB | 38 | SRS4 | 46 | CEALA |
| 4 | BBECLA | 34 | TONECHB | 39 | SRS3 | 47 | TS1 |
| 5 | TONECHA | 35 | BBECLB | 40 | SRS2 | 48 | TS2 |

2. The constant of capacitors connected to the terminals No.3, 4, 35 and 36 are designated by BBE Sound Inc.

3. The constant of capacitors connected to the terminals No.1,38,39,40,41,47 and 48 are designated by SRS Labs, Inc.

< MIXOUT, LFIN, LFOUT Low Pass Filter Setting >

LPF cut off frequency and quality factor are adjusted by the external parts and given by the following functions.

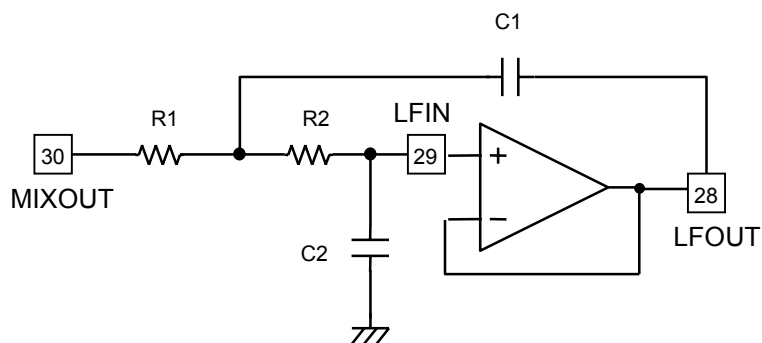

$$f_c = \frac{1}{2\pi\sqrt{R1 \cdot R2 \cdot C1 \cdot C2}} \text{ (Hz)}$$

$$Q = \frac{1}{\sqrt{\frac{C2 \cdot R1}{C1 \cdot R2}} + \sqrt{\frac{C1 \cdot R2}{C2 \cdot R1}}}$$

■ TERMINAL DESCRIPTION

| PIN NO. | SYMBOL | FUNCTION | EQUIVALENT CIRCUIT | TERMINAL VOLTAGE |
|--------------------|--------------------------------------|--|--------------------|------------------|
| 1 47 48 | TS3 TS1 TS2 | TruSurround Filter Capacitor 3 TruSurround Filter Capacitor 1 TruSurround Filter Capacitor 2 | | V+/2 |
| 2 37 | INA INB | Ach Input Bch Input | | V+/2 |
| 3 36 4 35 | BBECHA BBECHB BBECLA BBECLB | Ach BBE High-Pass Filter Capacitor Bch BBE High-Pass Filter Capacitor Ach BBE Low-Pass Filter Capacitor Bch BBE Low-Pass Filter Capacitor | | V+/2 |
| 5 34 | TONECHA TONECHB | Ach TONE Treble Filter Capacitor Bch TONE Treble Filter Capacitor | | V+/2 |

| PIN NO. | SYMBOL | FUNCTION | EQUIVALENT CIRCUIT | TERMINAL VOLTAGE |
|-------------------------------------|---|--|--------------------|------------------|
| 6 33 | TONECLA TONECLB | Ach TONE Bass Filter Capacitor Bch TONE Bass Filter Capacitor | | V+/2 |
| 7 8 9 28 30 31 32 | LINEOUTA OUTA OUTC LFOUT MIXOUT OUTB LINEOUTB | Ach Line Output Ach Output Center Output Buffer Output for LPF Ach Bch Mixed Output Bch Output Bch Line Output | | V+/2 |
| 11 | AGCTC | AGC Smoothing Filter Capacitor | | 1.4V |
| 12 | SURTC | Surround Switching Noise Rejection Capacitor | | - |

NJW1148

| PIN NO. | SYMBOL | FUNCTION | EQUIVALENT CIRCUIT | TERMINAL VOLTAGE |
|----------------|----------------------------|--|--------------------|------------------------------------|
| 13 14 15 | VOLATC VOLBTC VOLCTC | A ch Volume Switching Noise Rejection Capacitor B ch Volume Switching Noise Rejection Capacitor Center ch Volume Switching Noise Rejection Capacitor | | Vref-0.7V (Volume Max) (0dB) |
| 16 17 | SDA SCL | I ² C Data Input I ² C Clock Input | | - |
| 18 | GND | Ground | - | - |
| 20 | V+ | Power Supply | - | - |

| PIN NO. | SYMBOL | FUNCTION | EQUIVALENT CIRCUIT | TERMINAL VOLTAGE |
|---------|---------|---|--------------------|---|
| 21 | VREF | Reference Voltage Stabilizing Capacitor | | $V+/2$ |
| 22 | TOHEHC | Tone Control Treble Switching Noise Rejection Capacitor | | $V_{ref}-0.7V$ (Tone=FLAT) |
| 23 | TONELTC | Tone Control Bass Switching Noise Rejection Capacitor | | |
| 24 | OUTTC | Line Output switching Noise Rejection Capacitor | | 5V (OUT-ON) |
| 25 | BBELTC | BBE Low Switching Noise Rejection Capacitor | | $V_{ref}-0.7V$ (BBE=ON) (Low=0dB) |

NJW1148

| PIN NO. | SYMBOL | FUNCTION | EQUIVALENT CIRCUIT | TERMINAL VOLTAGE |
|----------------|----------------------|--|--------------------|-------------------------|
| 26 | BBEHTC | BBE High Switching Noise Rejection Capacitor | | Vref-0.7V (High=0dB) |
| 29 46 | LFIN CEALA | Buffer Output for LPF eala Filter Capacitor | | - |
| 38 39 40 | SRS4 SRS3 SRS2 | SRS Filter Capacitor 4 SRS Filter Capacitor 3 SRS Filter Capacitor 2 | | V+/2 |
| 41 | SRS1 | SRS Filter Capacitor 1 | | V+/2 |

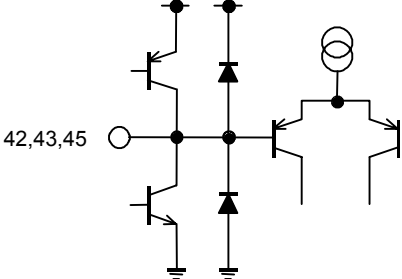
| PIN NO. | SYMBOL | FUNCTION | EQUIVALENT CIRCUIT | TERMINAL VOLTAGE |
|----------------|----------------------------|---|--|------------------|
| 42 43 45 | SPACE1 CENTER SPACE2 | SPACE Volume1 CENTER Volume SPACE Volume2 |  | V+/2 |

■ DEFINITION OF I²C REGISTER

● I²C BUS FORMAT

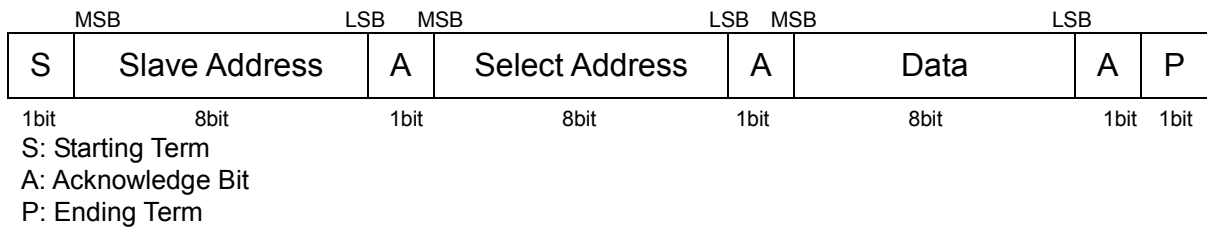

● SLAVE ADDRESS

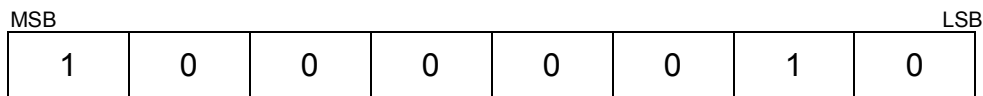

● CONTROL REGISTER TABLE

The select address sets each function (Volume, Balance, AGC, Surround, BBE, Tone Control).
The auto-increment function cycles the select address as follows.
00H→01H→02H→03H→04H→05H→06H→00H

| Select Address | BIT | | | | | | | | |
|----------------|-----------|------|----|----|----|-----|------------|------------|--|
| | D7 | D6 | D5 | D4 | D3 | D2 | D1 | D0 | |
| 00H | VOL | | | | | | | | |
| 01H | CHS | BAL | | | | | Don't Care | | |
| 02H | BCB | BASS | | | | | Don't Care | | |
| 03H | BCT | TREB | | | | | Don't Care | | |
| 04H | BBEL | | | | | BBE | Don't Care | | |
| 05H | BBEH | | | | | AGC | AGC LVL | | |
| 06H | 2 / 2.1ch | SUR | | | | | OUT | Don't Care | |

● CONTROL REGISTER DEFAULT VALUE

Control register default value is all "0".

| Select Address | BIT | | | | | | | |
|----------------|-----|----|----|----|----|----|----|----|
| | D7 | D6 | D5 | D4 | D3 | D2 | D1 | D0 |
| 00H | 0 | 0 | 0 | 0 | 0 | 0 | 0 | 0 |
| 01H | 0 | 0 | 0 | 0 | 0 | 0 | 0 | 0 |
| 02H | 0 | 0 | 0 | 0 | 0 | 0 | 0 | 0 |
| 03H | 0 | 0 | 0 | 0 | 0 | 0 | 0 | 0 |
| 04H | 0 | 0 | 0 | 0 | 0 | 0 | 0 | 0 |
| 05H | 0 | 0 | 0 | 0 | 0 | 0 | 0 | 0 |
| 06H | 0 | 0 | 0 | 0 | 0 | 0 | 0 | 0 |

● CONTROL COMMAND TABLE

a) Master Volume

| Select Address | BIT | | | | | | | |
|----------------|-----|----|----|----|----|----|----|----|
| | D7 | D6 | D5 | D4 | D3 | D2 | D1 | D0 |
| 00H | VOL | | | | | | | |

●VOL : Master Volume

Attenuation level : 0 to -80dB(0.33dB/step), MUTE

The volume is consisted of VOL1 and VOL2 and the level is divided into half to each VOL1 and VOL2.

ex) Volume setting is -2dB ; VOL1 and VOL2 is set -1dB each.

b) Balance

| Select Address | BIT | | | | | | | |
|----------------|-----|-----|----|----|----|----|------------|----|
| | D7 | D6 | D5 | D4 | D3 | D2 | D1 | D0 |
| 01H | CHS | BAL | | | | | Don't Care | |

●CHS : Balance channel select

“0” : Ach “Bch is attenuated”

“1” : Bch “Ach is attenuated”

●BAL : Ach and Bch Balance

Balance Level : 0 to -30dB (1dB/Step) , MUTE

c) Tone Control BASS

| Select Address | BIT | | | | | | | |
|----------------|-----|------|----|----|----|----|------------|----|
| | D7 | D6 | D5 | D4 | D3 | D2 | D1 | D0 |
| 02H | BCB | BASS | | | | | Don't Care | |

●BCB : Bass Boost or Cut

“0” : Cut

“1” : Boost

●BASS : BASS Level

Cut Level : -15 to 0dB(0.5dB/Step)

Boost Level : 0 to +15dB(0.5dB/Step)

e) Tone Control TREBLE

| Select Address | BIT | | | | | | | |
|----------------|-----|------|----|----|----|----|------------|----|
| | D7 | D6 | D5 | D4 | D3 | D2 | D1 | D0 |
| 03H | BCT | TREB | | | | | Don't Care | |

●BCT : Treble Boost or Cut

“0” : Cut

“1” : Boost

●TREB : Treble Level

Cut Level : -15 to 0dB(0.5dB/Step)

Boost Level : 0 to +15dB(0.5dB/Step)

f) BBE-Low

| Select Address | BIT | | | | | | | |
|----------------|------|----|----|----|----|-----|------------|----|
| | D7 | D6 | D5 | D4 | D3 | D2 | D1 | D0 |
| 04H | BBEL | | | | | BBE | Don't Care | |

●BBEL:BBE-LOW Level

0dB to 15dB (0.5dB/step)

●BBE : BBE ON or OFF

g) BBE-High

| Select Address | BIT | | | | | | | |
|----------------|------|----|----|----|----|-----|---------|----|
| | D7 | D6 | D5 | D4 | D3 | D2 | D1 | D0 |
| 05H | BBEH | | | | | AGC | AGC LVL | |

- BBEH: BBE-HIGH Level**

0dB to 15dB (0.5dB/step)

- AGC : AGC ON or OFF**

- AGC LVL : AGC Level**

300mVrms, 400mVrms, 500mVrms, 600mVrms

h) Surround (eala, TruSurround)

| Select Address | BIT | | | | | | | |
|----------------|-----------|-----|----|----|----|-----|------------|----|
| | D7 | D6 | D5 | D4 | D3 | D2 | D1 | D0 |
| 06H | 2 / 2.1ch | SUR | | | | OUT | Don't care | |

- 2 / 2.1ch : Surround Output Mode**

2ch (TruSurround), 2.1ch (Center out)

- SUR : Surround Mode**

OFF, MONO, SRS 3D, TS, eala1, 2,3,4,5,6

- OUT : Output Switch**

Output ON / OFF

■ Master Volume (Select Address: 00H)

| | | VOL | | | | | | | |
|----------|-----|-----|----|----|----|----|----|----|----|
| Gain(dB) | HEX | D7 | D6 | D5 | D4 | D3 | D2 | D1 | D0 |
| 0 | FF | 1 | 1 | 1 | 1 | 1 | 1 | 1 | 1 |
| -1 | FC | 1 | 1 | 1 | 1 | 1 | 1 | 0 | 0 |
| -2 | F9 | 1 | 1 | 1 | 1 | 1 | 0 | 0 | 1 |
| -3 | F6 | 1 | 1 | 1 | 1 | 0 | 1 | 1 | 0 |
| -4 | F3 | 1 | 1 | 1 | 1 | 0 | 0 | 1 | 1 |
| -5 | F0 | 1 | 1 | 1 | 1 | 0 | 0 | 0 | 0 |
| -6 | ED | 1 | 1 | 1 | 0 | 1 | 1 | 0 | 1 |
| -7 | EA | 1 | 1 | 1 | 0 | 1 | 0 | 1 | 0 |
| -8 | E7 | 1 | 1 | 1 | 0 | 0 | 1 | 1 | 1 |
| -9 | E4 | 1 | 1 | 1 | 0 | 0 | 1 | 0 | 0 |
| -10 | E1 | 1 | 1 | 1 | 0 | 0 | 0 | 0 | 1 |
| -11 | DE | 1 | 1 | 0 | 1 | 1 | 1 | 1 | 0 |
| -12 | DB | 1 | 1 | 0 | 1 | 1 | 0 | 1 | 1 |
| -13 | D8 | 1 | 1 | 0 | 1 | 1 | 0 | 0 | 0 |
| -14 | D5 | 1 | 1 | 0 | 1 | 0 | 1 | 0 | 1 |
| -15 | D2 | 1 | 1 | 0 | 1 | 0 | 0 | 1 | 0 |
| -16 | CF | 1 | 1 | 0 | 0 | 1 | 1 | 1 | 1 |
| -17 | CC | 1 | 1 | 0 | 0 | 1 | 1 | 0 | 0 |
| -18 | C9 | 1 | 1 | 0 | 0 | 1 | 0 | 0 | 1 |
| -19 | C6 | 1 | 1 | 0 | 0 | 0 | 1 | 1 | 0 |
| -20 | C3 | 1 | 1 | 0 | 0 | 0 | 0 | 1 | 1 |
| -21 | C0 | 1 | 1 | 0 | 0 | 0 | 0 | 0 | 0 |
| -22 | BD | 1 | 0 | 1 | 1 | 1 | 1 | 0 | 1 |
| -23 | BA | 1 | 0 | 1 | 1 | 1 | 0 | 1 | 0 |
| -24 | B7 | 1 | 0 | 1 | 1 | 0 | 1 | 1 | 1 |
| -25 | B4 | 1 | 0 | 1 | 1 | 0 | 1 | 0 | 0 |
| -26 | B1 | 1 | 0 | 1 | 1 | 0 | 0 | 0 | 1 |
| -27 | AE | 1 | 0 | 1 | 0 | 1 | 1 | 1 | 0 |
| -28 | AB | 1 | 0 | 1 | 0 | 1 | 0 | 1 | 1 |
| -29 | A8 | 1 | 0 | 1 | 0 | 1 | 0 | 0 | 0 |
| -30 | A5 | 1 | 0 | 1 | 0 | 0 | 1 | 0 | 1 |
| -31 | A2 | 1 | 0 | 1 | 0 | 0 | 0 | 1 | 0 |
| -32 | 9F | 1 | 0 | 0 | 1 | 1 | 1 | 1 | 1 |
| -33 | 9C | 1 | 0 | 0 | 1 | 1 | 1 | 0 | 0 |
| -34 | 99 | 1 | 0 | 0 | 1 | 1 | 0 | 0 | 1 |
| -35 | 96 | 1 | 0 | 0 | 1 | 0 | 1 | 1 | 0 |
| -36 | 93 | 1 | 0 | 0 | 1 | 0 | 0 | 1 | 1 |
| -37 | 90 | 1 | 0 | 0 | 1 | 0 | 0 | 0 | 0 |
| -38 | 8D | 1 | 0 | 0 | 0 | 1 | 1 | 0 | 1 |
| -39 | 8A | 1 | 0 | 0 | 0 | 1 | 0 | 1 | 0 |
| -40 | 87 | 1 | 0 | 0 | 0 | 0 | 1 | 1 | 1 |
| -41 | 84 | 1 | 0 | 0 | 0 | 0 | 1 | 0 | 0 |
| -42 | 81 | 1 | 0 | 0 | 0 | 0 | 0 | 0 | 1 |

| | | VOL | | | | | | | |
|----------|-----|-----|----|----|----|----|----|----|----|
| Gain(dB) | HEX | D7 | D6 | D5 | D4 | D3 | D2 | D1 | D0 |
| -43 | 7E | 0 | 1 | 1 | 1 | 1 | 1 | 1 | 0 |
| -44 | 7B | 0 | 1 | 1 | 1 | 1 | 0 | 1 | 1 |
| -45 | 78 | 0 | 1 | 1 | 1 | 1 | 0 | 0 | 0 |
| -46 | 75 | 0 | 1 | 1 | 1 | 0 | 1 | 0 | 1 |
| -47 | 72 | 0 | 1 | 1 | 1 | 0 | 0 | 1 | 0 |
| -48 | 6F | 0 | 1 | 1 | 0 | 1 | 1 | 1 | 1 |
| -49 | 6C | 0 | 1 | 1 | 0 | 1 | 1 | 0 | 0 |
| -50 | 69 | 0 | 1 | 1 | 0 | 1 | 0 | 0 | 1 |
| -51 | 66 | 0 | 1 | 1 | 0 | 0 | 1 | 1 | 0 |
| -52 | 63 | 0 | 1 | 1 | 0 | 0 | 0 | 1 | 1 |
| -53 | 60 | 0 | 1 | 1 | 0 | 0 | 0 | 0 | 0 |
| -54 | 5D | 0 | 1 | 0 | 1 | 1 | 1 | 0 | 1 |
| -55 | 5A | 0 | 1 | 0 | 1 | 1 | 0 | 1 | 0 |
| -56 | 57 | 0 | 1 | 0 | 1 | 0 | 1 | 1 | 1 |
| -57 | 54 | 0 | 1 | 0 | 1 | 0 | 1 | 0 | 0 |
| -58 | 51 | 0 | 1 | 0 | 1 | 0 | 0 | 0 | 1 |
| -59 | 4E | 0 | 1 | 0 | 0 | 1 | 1 | 1 | 0 |
| -60 | 4B | 0 | 1 | 0 | 0 | 1 | 0 | 1 | 1 |
| -61 | 48 | 0 | 1 | 0 | 0 | 1 | 0 | 0 | 0 |
| -62 | 45 | 0 | 1 | 0 | 0 | 0 | 1 | 0 | 1 |
| -63 | 42 | 0 | 1 | 0 | 0 | 0 | 0 | 1 | 0 |
| -64 | 3F | 0 | 0 | 1 | 1 | 1 | 1 | 1 | 1 |
| -65 | 3C | 0 | 0 | 1 | 1 | 1 | 1 | 0 | 0 |
| -66 | 39 | 0 | 0 | 1 | 1 | 1 | 0 | 0 | 1 |
| -67 | 36 | 0 | 0 | 1 | 1 | 0 | 1 | 1 | 0 |
| -68 | 33 | 0 | 0 | 1 | 1 | 0 | 0 | 1 | 1 |
| -69 | 30 | 0 | 0 | 1 | 1 | 0 | 0 | 0 | 0 |
| -70 | 2D | 0 | 0 | 1 | 0 | 1 | 1 | 0 | 1 |
| -71 | 2A | 0 | 0 | 1 | 0 | 1 | 0 | 1 | 0 |
| -72 | 27 | 0 | 0 | 1 | 0 | 0 | 1 | 1 | 1 |
| -73 | 24 | 0 | 0 | 1 | 0 | 0 | 1 | 0 | 0 |
| -74 | 21 | 0 | 0 | 1 | 0 | 0 | 0 | 0 | 1 |
| -75 | 1E | 0 | 0 | 0 | 1 | 1 | 1 | 1 | 0 |
| -76 | 1B | 0 | 0 | 0 | 1 | 1 | 0 | 1 | 1 |
| -77 | 18 | 0 | 0 | 0 | 1 | 1 | 0 | 0 | 0 |
| -78 | 15 | 0 | 0 | 0 | 1 | 0 | 1 | 0 | 1 |
| -79 | 12 | 0 | 0 | 0 | 1 | 0 | 0 | 1 | 0 |
| -80 | 0F | 0 | 0 | 0 | 0 | 1 | 1 | 1 | 1 |
| Mute | 00 | 0 | 0 | 0 | 0 | 0 | 0 | 0 | 0 |

■ Balance (Select Address: 01H)

| Channel Setting (CHS) | D7 |
|-----------------------|----|
| Attenuated Bch Gain | 0 |
| Attenuated Ach Gain | 1 |

| Gain(dB) | BAL | | | | |
|----------|-----|----|----|----|----|
| | D6 | D5 | D4 | D3 | D2 |
| 0 | 0 | 0 | 0 | 0 | 0 |
| -1 | 0 | 0 | 0 | 0 | 1 |
| -2 | 0 | 0 | 0 | 1 | 0 |
| -3 | 0 | 0 | 0 | 1 | 1 |
| -4 | 0 | 0 | 1 | 0 | 0 |
| -5 | 0 | 0 | 1 | 0 | 1 |
| -6 | 0 | 0 | 1 | 1 | 0 |
| -7 | 0 | 0 | 1 | 1 | 1 |
| -8 | 0 | 1 | 0 | 0 | 0 |
| -9 | 0 | 1 | 0 | 0 | 1 |
| -10 | 0 | 1 | 0 | 1 | 0 |
| -11 | 0 | 1 | 0 | 1 | 1 |
| -12 | 0 | 1 | 1 | 0 | 0 |
| -13 | 0 | 1 | 1 | 0 | 1 |
| -14 | 0 | 1 | 1 | 1 | 0 |
| -15 | 0 | 1 | 1 | 1 | 1 |
| -16 | 1 | 0 | 0 | 0 | 0 |
| -17 | 1 | 0 | 0 | 0 | 1 |
| -18 | 1 | 0 | 0 | 1 | 0 |
| -19 | 1 | 0 | 0 | 1 | 1 |
| -20 | 1 | 0 | 1 | 0 | 0 |
| -21 | 1 | 0 | 1 | 0 | 1 |
| -22 | 1 | 0 | 1 | 1 | 0 |
| -23 | 1 | 0 | 1 | 1 | 1 |
| -24 | 1 | 1 | 0 | 0 | 0 |
| -25 | 1 | 1 | 0 | 0 | 1 |
| -26 | 1 | 1 | 0 | 1 | 0 |
| -27 | 1 | 1 | 0 | 1 | 1 |
| -28 | 1 | 1 | 1 | 0 | 0 |
| -29 | 1 | 1 | 1 | 0 | 1 |
| -30 | 1 | 1 | 1 | 1 | 0 |
| MUTE | 1 | 1 | 1 | 1 | 1 |

■ Tone Control Bass (Select Address: 02H)

| Bass Cut or Boost | BCB |
|----------------------|-----|
| | D7 |
| Cut | 0 |
| Boost | 1 |

| | | BASS | | | | |
|--------------|----------------|------|----|----|----|----|
| Cut Gain(dB) | Boost Gain(dB) | D6 | D5 | D4 | D3 | D2 |
| -15 | 15 | 1 | 1 | 1 | 1 | 0 |
| -14 | 14 | 1 | 1 | 1 | 0 | 0 |
| -13 | 13 | 1 | 1 | 0 | 1 | 0 |
| -12 | 12 | 1 | 1 | 0 | 0 | 0 |
| -11 | 11 | 1 | 0 | 1 | 1 | 0 |
| -10 | 10 | 1 | 0 | 1 | 0 | 0 |
| -9 | 9 | 1 | 0 | 0 | 1 | 0 |
| -8 | 8 | 1 | 0 | 0 | 0 | 0 |
| -7 | 7 | 0 | 1 | 1 | 1 | 0 |
| -6 | 6 | 0 | 1 | 1 | 0 | 0 |
| -5 | 5 | 0 | 1 | 0 | 1 | 0 |
| -4 | 4 | 0 | 1 | 0 | 0 | 0 |
| -3 | 3 | 0 | 0 | 1 | 1 | 0 |
| -2 | 2 | 0 | 0 | 1 | 0 | 0 |
| -1 | 1 | 0 | 0 | 0 | 1 | 0 |
| 0 | 0 | 0 | 0 | 0 | 0 | 0 |

■ Tone Control Treble (Select Address: 03H)

| Treble Cut or Boost | BCT |
|------------------------|-----|
| | D7 |
| Cut | 0 |
| Boost | 1 |

| | | TREB | | | | |
|--------------|----------------|------|----|----|----|----|
| Cut Gain(dB) | Boost Gain(dB) | D6 | D5 | D4 | D3 | D2 |
| -15 | 15 | 1 | 1 | 1 | 1 | 0 |
| -14 | 14 | 1 | 1 | 1 | 0 | 0 |
| -13 | 13 | 1 | 1 | 0 | 1 | 0 |
| -12 | 12 | 1 | 1 | 0 | 0 | 0 |
| -11 | 11 | 1 | 0 | 1 | 1 | 0 |
| -10 | 10 | 1 | 0 | 1 | 0 | 0 |
| -9 | 9 | 1 | 0 | 0 | 1 | 0 |
| -8 | 8 | 1 | 0 | 0 | 0 | 0 |
| -7 | 7 | 0 | 1 | 1 | 1 | 0 |
| -6 | 6 | 0 | 1 | 1 | 0 | 0 |
| -5 | 5 | 0 | 1 | 0 | 1 | 0 |
| -4 | 4 | 0 | 1 | 0 | 0 | 0 |
| -3 | 3 | 0 | 0 | 1 | 1 | 0 |
| -2 | 2 | 0 | 0 | 1 | 0 | 0 |
| -1 | 1 | 0 | 0 | 0 | 1 | 0 |
| 0 | 0 | 0 | 0 | 0 | 0 | 0 |

■ BBE-LOW Gain Code (Select Address: 04H)

| Gain(dB) | BBEL | | | | |
|----------|------|----|----|----|----|
| | D7 | D6 | D5 | D4 | D3 |
| 15 | 1 | 1 | 1 | 1 | 0 |
| 14 | 1 | 1 | 1 | 0 | 0 |
| 13 | 1 | 1 | 0 | 1 | 0 |
| 12 | 1 | 1 | 0 | 0 | 0 |
| 11 | 1 | 0 | 1 | 1 | 0 |
| 10 | 1 | 0 | 1 | 0 | 0 |
| 9 | 1 | 0 | 0 | 1 | 0 |
| 8 | 1 | 0 | 0 | 0 | 0 |
| 7 | 0 | 1 | 1 | 1 | 0 |
| 6 | 0 | 1 | 1 | 0 | 0 |
| 5 | 0 | 1 | 0 | 1 | 0 |
| 4 | 0 | 1 | 0 | 0 | 0 |
| 3 | 0 | 0 | 1 | 1 | 0 |
| 2 | 0 | 0 | 1 | 0 | 0 |
| 1 | 0 | 0 | 0 | 1 | 0 |
| 0 | 0 | 0 | 0 | 0 | 0 |

■ BBE (Select Address: 04H)

| BBE ON/OFF | BBE |
|------------|-----|
| | D2 |
| OFF | 0 |
| ON | 1 |

■ BBE-HIGH Gain Code (Select Address: 05H)

| Gain(dB) | BBEH | | | | |
|----------|------|----|----|----|----|
| | D7 | D6 | D5 | D4 | D3 |
| 15 | 1 | 1 | 1 | 1 | 0 |
| 14 | 1 | 1 | 1 | 0 | 0 |
| 13 | 1 | 1 | 0 | 1 | 0 |
| 12 | 1 | 1 | 0 | 0 | 0 |
| 11 | 1 | 0 | 1 | 1 | 0 |
| 10 | 1 | 0 | 1 | 0 | 0 |
| 9 | 1 | 0 | 0 | 1 | 0 |
| 8 | 1 | 0 | 0 | 0 | 0 |
| 7 | 0 | 1 | 1 | 1 | 0 |
| 6 | 0 | 1 | 1 | 0 | 0 |
| 5 | 0 | 1 | 0 | 1 | 0 |
| 4 | 0 | 1 | 0 | 0 | 0 |
| 3 | 0 | 0 | 1 | 1 | 0 |
| 2 | 0 | 0 | 1 | 0 | 0 |
| 1 | 0 | 0 | 0 | 1 | 0 |
| 0 | 0 | 0 | 0 | 0 | 0 |

■ AGC (Select Address: 05H)

| AGC ON/OFF | AGC |
|------------|-----|
| | D2 |
| OFF | 0 |
| ON | 1 |

■ AGC Level (Select Address: 05H)

| AGC Level | AGC LVL | |
|-----------|---------|----|
| | D1 | D0 |
| 300mVrms | 0 | 0 |
| 400mVrms | 0 | 1 |
| 500mVrms | 1 | 0 |
| 600mVrms | 1 | 1 |

■ 2 / 2.1ch (Select Address: 06H)

| 2 / 2.1ch | 2 / 2.1ch |
|-----------|-----------|
| | D7 |
| 2ch | 0 |
| 2.1ch | 1 |

■ Surround Mode (Select Address: 06H)

| SUR | SUR | | | |
|--------|-----|----|----|----|
| | D6 | D5 | D4 | D3 |
| OFF | 0 | 0 | 0 | 0 |
| MONO | 1 | 1 | 1 | 1 |
| SRS 3D | 1 | 1 | 1 | 0 |
| TS | 1 | 1 | 0 | 1 |
| eala 1 | 0 | 0 | 0 | 1 |
| eala 2 | 0 | 0 | 1 | 0 |
| eala 3 | 0 | 0 | 1 | 1 |
| eala 4 | 0 | 1 | 0 | 0 |
| eala 5 | 0 | 1 | 0 | 1 |
| eala 6 | 0 | 1 | 1 | 0 |

■ Output Switch (Select Address: 06H)

| Output Switch | OUT |
|---------------|-----|
| | D2 |
| OFF | 0 |
| ON | 1 |

TYPICAL CHARACTERISTICS

Operating Current vs. Power Supply Voltage

$R_L=47k\Omega$, VOL=0dB, BAL=0dB, AGC=OFF,
BASS=TREB=0dB, BBE=OFF, Surround=OFF

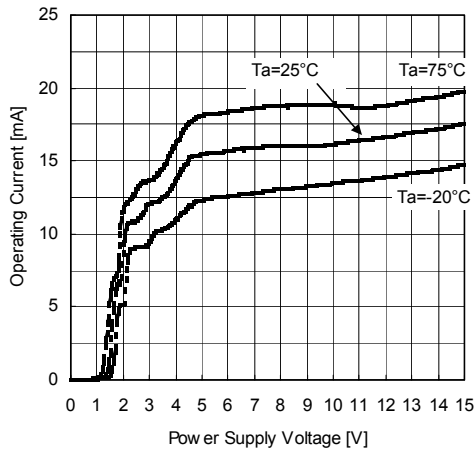

Operating Current vs. Ambient Temperature

$V+=9V$, $R_L=47k\Omega$, VOL=0dB, BAL=0dB, AGC=OFF,
BASS=TREB=0dB, BBE=OFF, Surround=OFF

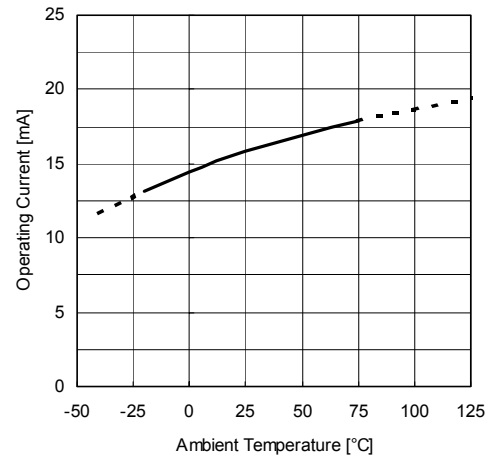

Reference Voltage vs. Power Supply Voltage

$R_L=47k\Omega$, VOL=0dB, BAL=0dB, AGC=OFF,
BASS=TREB=0dB, BBE=OFF, Surround=OFF

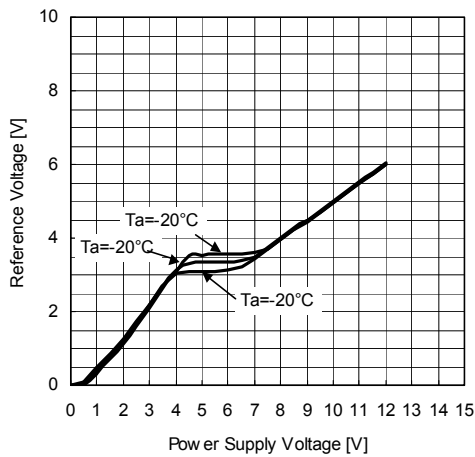

Reference Voltage vs. Ambient Temperature

$V+=9V$, $R_L=47k\Omega$, VOL=0dB, BAL=0dB, AGC=OFF,
BASS=TREB=0dB, BBE=OFF, Surround=OFF

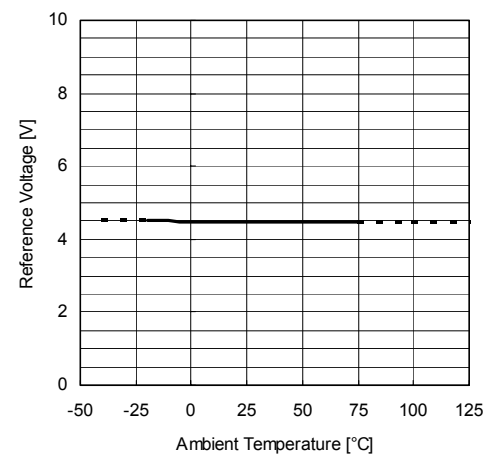

Voltage Gain vs. Volume Control

$V+=9V$, $R_L=47k\Omega$, $V_{in}(Ach)=1V_{rms}$, $f=1kHz$, BW=400Hz-30kHz,
BAL=0dB, AGC=OFF, BASS=TREB=0dB, BBE=OFF, Surround=OFF

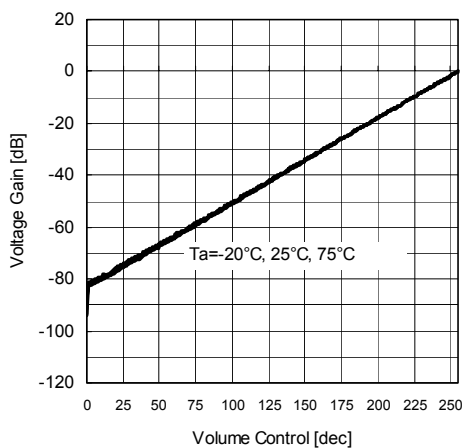

Voltage Gain vs. Balance Control

$V+=9V$, $R_L=47k\Omega$, $V_{in}(Ach)=1V_{rms}$, $f=1kHz$, BW=400Hz-30kHz,
VOL=0dB, AGC=OFF, BASS=TREB=0dB, BBE=OFF, Surround=OFF

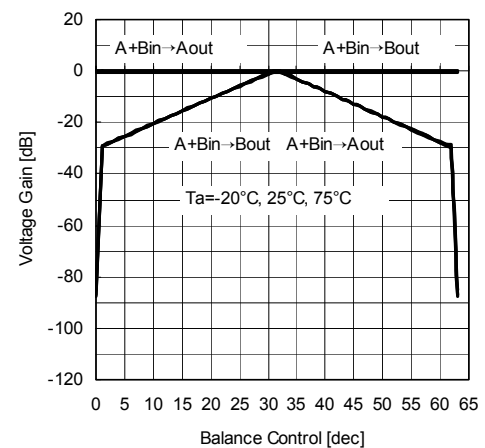

TYPICAL CHARACTERISTICS

Total Harmonic Distortion vs. Input Voltage

V+=9V, R_L=47kΩ, Vin(Ach), f=1kHz, BW=400Hz-30kHz, VOL=-20dB, BAL=0dB, AGC=OFF, BASS=TREB=0dB, BBE=OFF, Surround=OFF

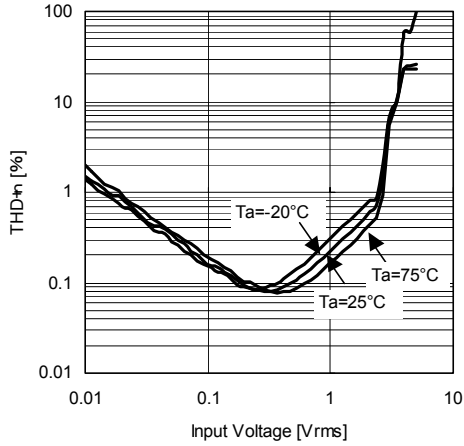

Total Harmonic Distortion vs. Input Voltage

Ta=25°C, V+=9V, R_L=47kΩ, Vin(Ach), f=1kHz, BW=400Hz-30kHz, BAL=0dB, AGC=OFF, BASS=TREB=0dB, BBE=OFF, Surround=OFF

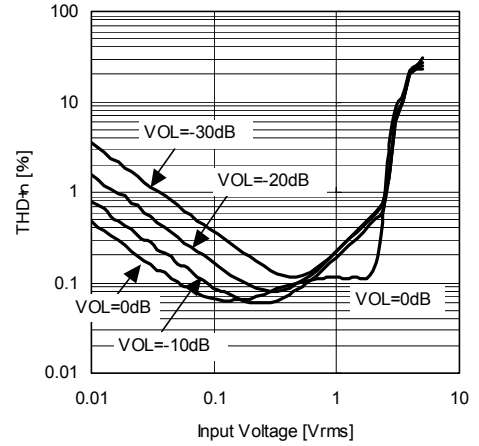

Total Harmonic Distortion vs. Output Voltage

V+=9V, R_L=47kΩ, Vin(Ach), f=1kHz, BW=400Hz-30kHz, VOL=0dB, BAL=0dB, AGC=OFF, BASS=TREB=0dB, BBE=OFF, Surround=OFF

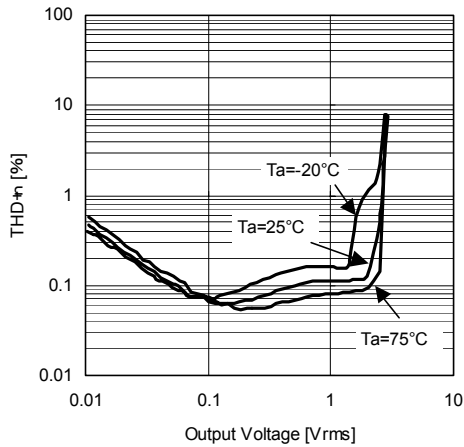

Total Harmonic Distortion vs. Output Voltage

Ta=25°C, V+=9V, R_L=47kΩ, Vin(Ach), f=1kHz, BW=400Hz-30kHz, BAL=0dB, AGC=OFF, BASS=TREB=0dB, BBE=OFF, Surround=OFF

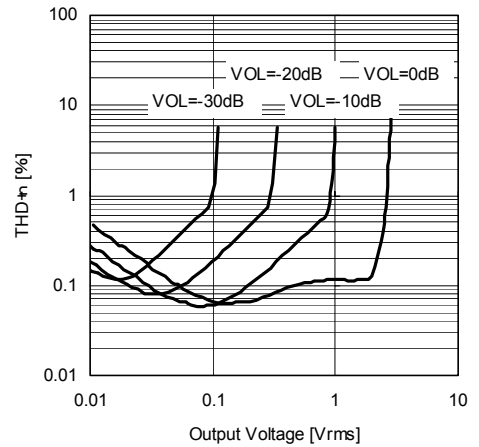

Channel Separation vs. Frequency

V+=9V, R_L=47kΩ, Vin=1Vrms, BW=10Hz-30kHz, VOL=0dB, BAL=0dB, AGC=OFF, BASS=TREB=0dB, BBE=OFF, Surround=OFF

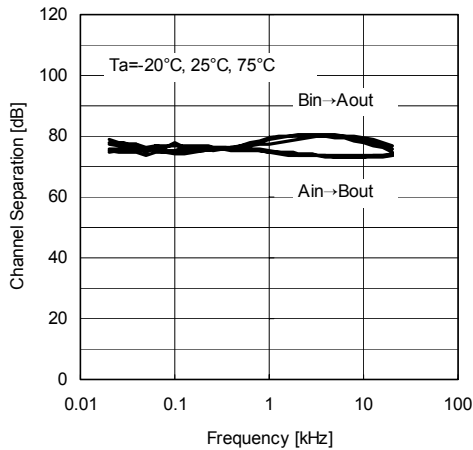

Mute Level vs. Frequency

V+=9V, R_L=47kΩ, Vin=1Vrms, BW=10Hz-30kHz, VOL=MUTE, BAL=0dB, AGC=OFF, BASS=TREB=0dB, BBE=OFF, Surround=OFF

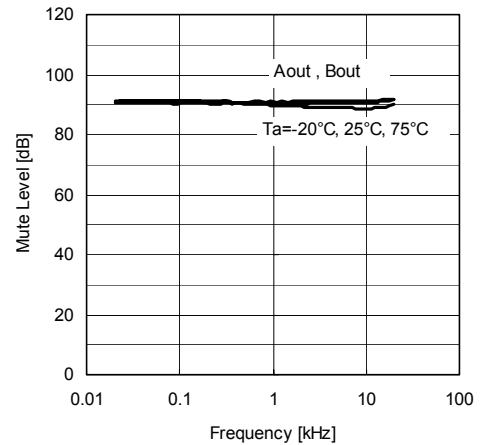

TYPICAL CHARACTERISTICS

Voltage Gain (LINE) vs. Frequency
 Ta=25°C, V+=9V, R_i=47kΩ, Vin(Ach)=0.1Vrms, Vout(LINEAch),
 VOL=0dB, BAL=0dB, AGC=OFF, BASS=TREB=0dB, BBE=OFF, Surround=OFF

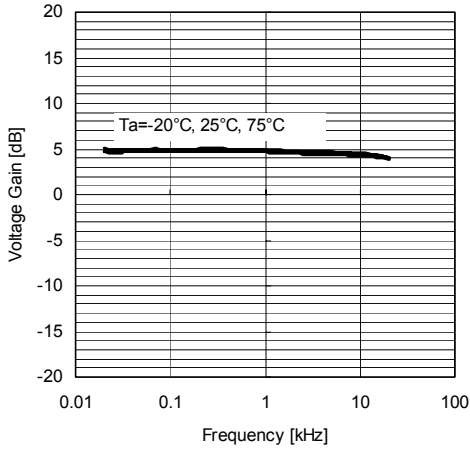

Output Noise Voltage (OUT) vs. Frequency
 V+=9V, R_i=47kΩ, BAL=0dB, AGC=OFF,
 BASS=TREB=0dB, BBE=OFF, Surround=OFF

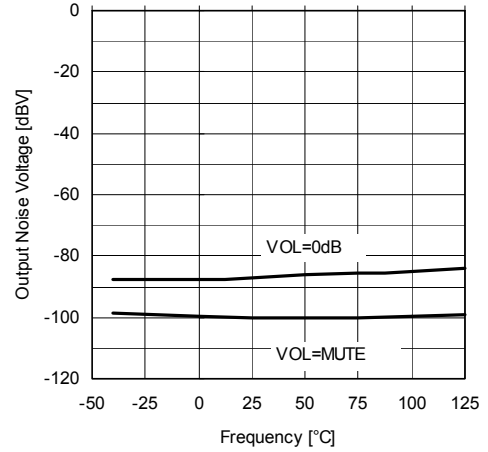

Output Noise Voltage (LINE) vs. Frequency
 V+=9V, R_i=47kΩ, BAL=0dB, AGC=OFF,
 BASS=TREB=0dB, BBE=OFF, Surround=OFF

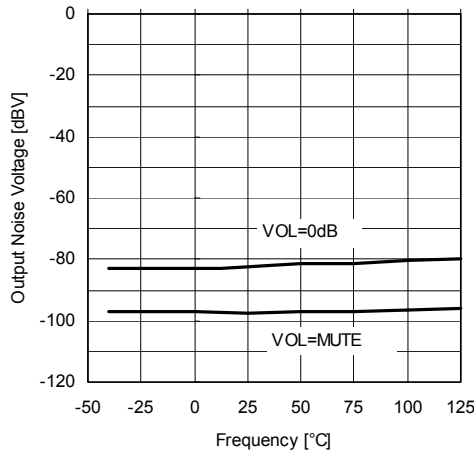

AGC Output Voltage vs. Input Voltage
 V+=9V, R_i=47kΩ, Vin(A+Bch), f=1kHz, Vout(Ach), BW=400Hz-30kHz,
 VOL=0dB, BAL=0dB, AGC=300mV, BASS=TREB=0dB, BBE=OFF, Surround=OFF

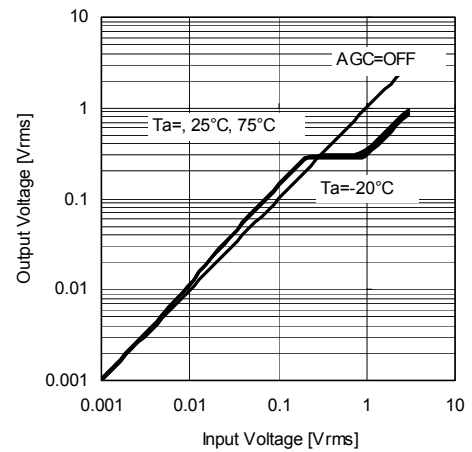

AGC Output Voltage vs. Input Voltage
 Ta=25°C, V+=9V, R_i=47kΩ, Vin(A+Bch), f=1kHz, Vout(Ach), BW=400Hz-30kHz,
 VOL=0dB, BAL=0dB, BASS=TREB=0dB, BBE=OFF, Surround=OFF

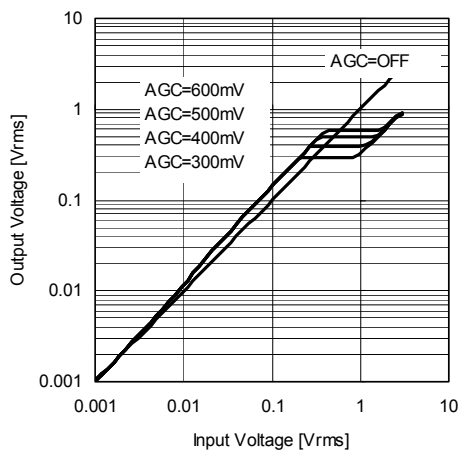

AGC Attack Time Response
 Ta=25°C, V+=9V, R_i=47kΩ, Vin(A+Bch), f=20kHz, Vout(Ach), BW=400Hz-30kHz,
 VOL=0dB, BAL=0dB, AGC=300mV, BASS=TREB=0dB, BBE=OFF, Surround=OFF

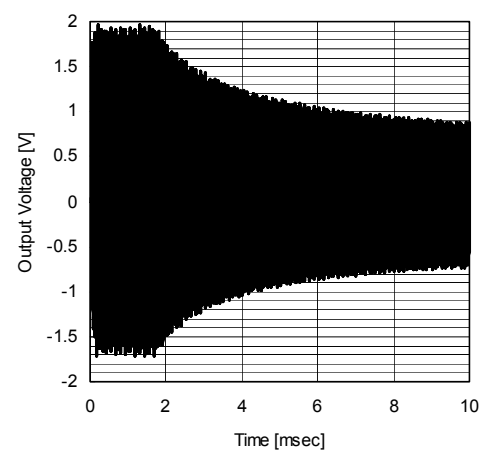

TYPICAL CHARACTERISTICS

AGC Recovery Time Response

Ta=25°C, V+=9V, R_L=47kΩ, Vin(A+Bch), f=10kHz, Vout(Ach), BW=400Hz-30kHz, VOL=0dB, BAL=0dB, AGC=300mV, BASS=TREB=0dB, BBE=OFF, Surround=OFF

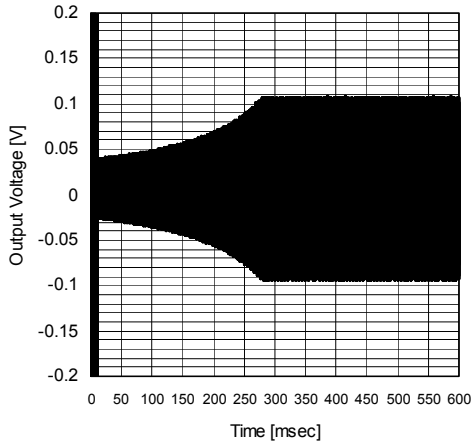

Voltage Gain vs. Frequency (TONE)

Ta=25°C, V+=9V, R_L=47kΩ, Vin(Ach)=0.1Vrms, Vout(Ach), VOL=0dB, BAL=0dB, AGC=OFF, BBE=OFF, eala=By pass, TS=By pass

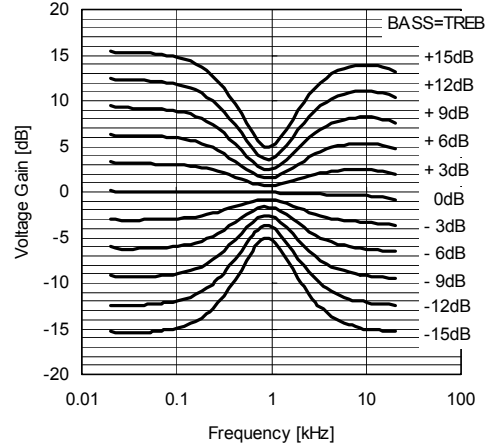

Voltage Gain vs. Frequency (TONE)

Ta=25°C, V+=9V, R_L=47kΩ, Vin(Ach)=0.1Vrms, Vout(Ach), VOL=0dB, BAL=0dB, AGC=OFF, BBE=OFF, eala=By pass, TS=By pass

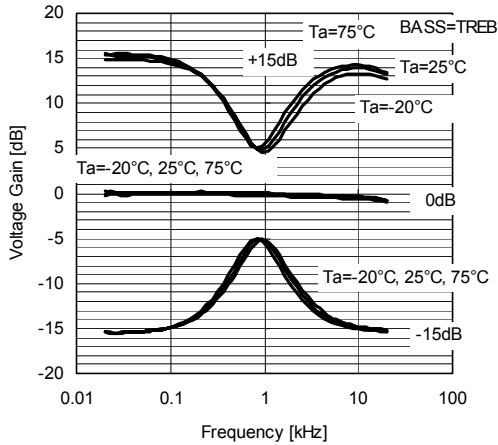

Voltage Gain vs. Frequency (BBE)

Ta=25°C, V+=9V, R_L=47kΩ, Vin(Lch)=0.1Vrms, Vout(Ach), VOL=0dB, BAL=0dB, BASS=TREB=0dB, AGC=OFF, Surround=OFF

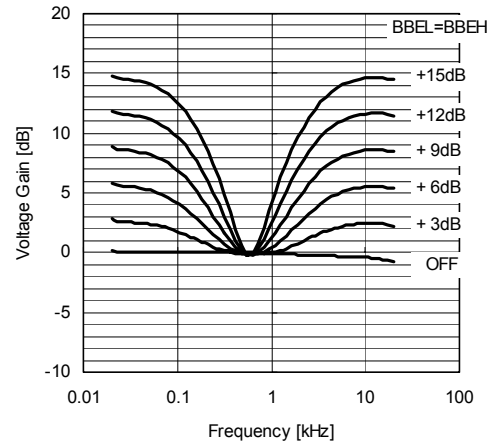

Voltage Gain vs. Frequency (BBE)

V+=9V, R_L=47kΩ, Vin(Lch)=0.1Vrms, Vout(Ach), VOL=0dB, BAL=0dB, BASS=TREB=0dB, AGC=OFF, Surround=OFF

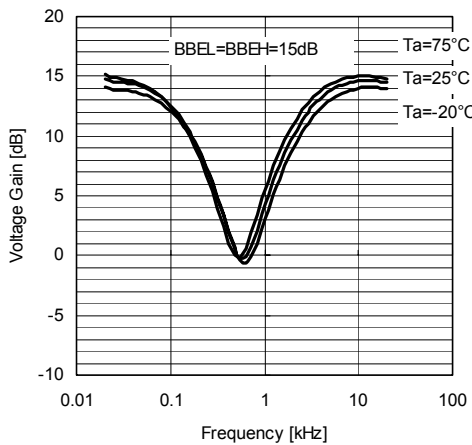

Phase vs. Frequency (BBE)

Ta=25°C, V+=9V, R_L=47kΩ, Vin(Lch)=0.1Vrms, Vout(Ach), VOL=0dB, BAL=0dB, BASS=TREB=0dB, AGC=OFF, Surround=OFF

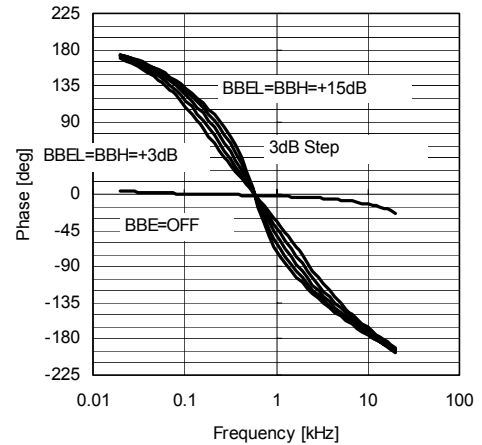

TYPICAL CHARACTERISTICS

Voltage Gain vs. Frequency (MONO)

V+=9V, R_L=47kΩ, Vin(A+Bch)=0.1Vrms, Vout(Ach), VOL=0dB, BAL=0dB, BASS=TREB=0dB, AGC=OFF, BBE=OFF, Surround=MONO

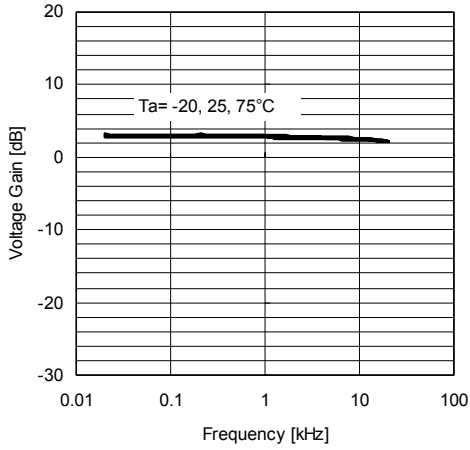

Phase vs. Frequency (MONO)

V+=9V, R_L=47kΩ, Vin(A+Bch)=0.1Vrms, VOL=0dB, BAL=0dB, BASS=TREB=0dB, AGC=OFF, BBE=OFF, Surround=MONO

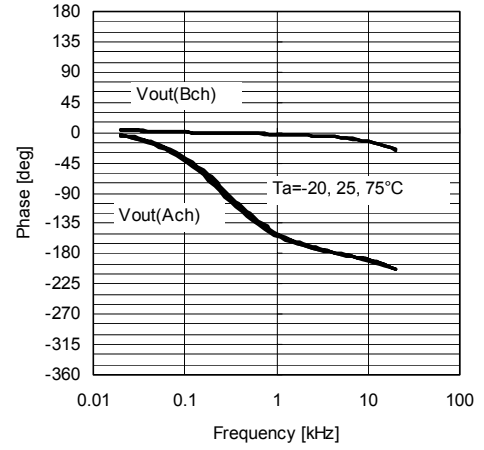

Voltage Gain vs. Frequency (eala Ach)

V+=9V, R_L=47kΩ, Vin=0.1Vrms, Vout(Ach), VOL=0dB, BAL=0dB, BASS=TREB=0dB, AGC=OFF, BBE=OFF, Surround=eala

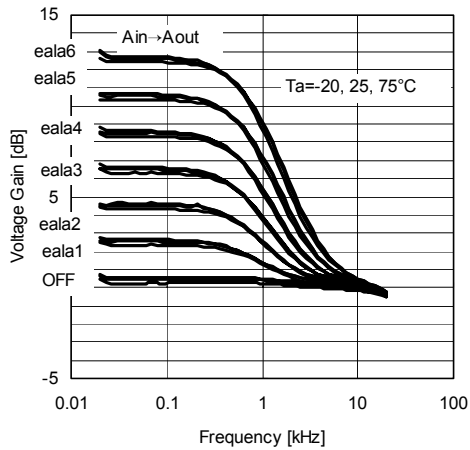

Voltage Gain vs. Frequency (eala Bch)

V+=9V, R_L=47kΩ, Vin=0.1Vrms, Vout(Ach), VOL=0dB, BAL=0dB, BASS=TREB=0dB, AGC=OFF, BBE=OFF, Surround=eala

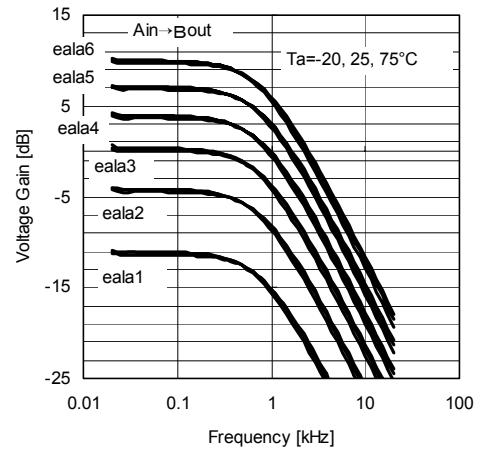

Voltage Gain vs. Frequency (TS2)

V+=9V, R_L=47kΩ, Vin=0.1Vrms, VOL=0dB, BAL=0dB, BASS=TREB=0dB, AGC=OFF, BBE=OFF, Surround=TS_2ch

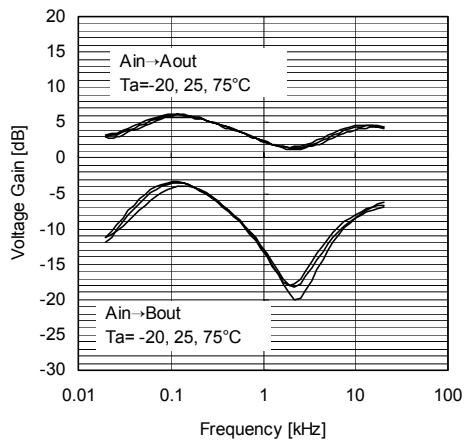

Voltage Gain vs. Frequency (TS2.1)

V+=9V, R_L=47kΩ, Vin=0.1Vrms, VOL=0dB, BAL=0dB, BASS=TREB=0dB, AGC=OFF, BBE=OFF, Surround=TS_2.1ch

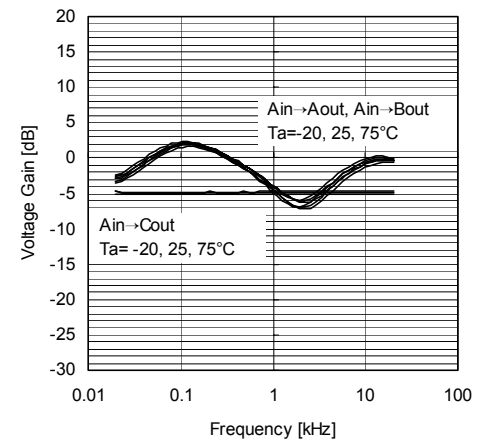

TYPICAL CHARACTERISTICS

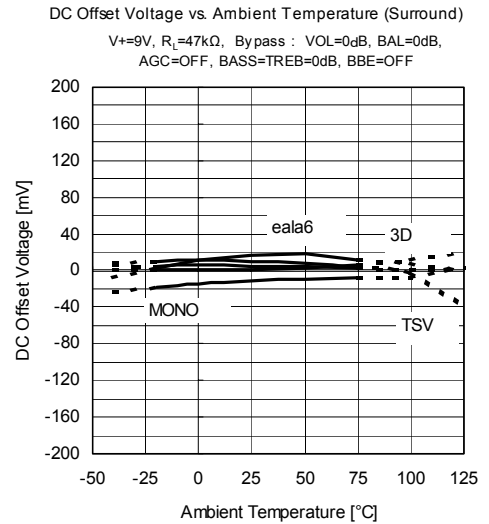
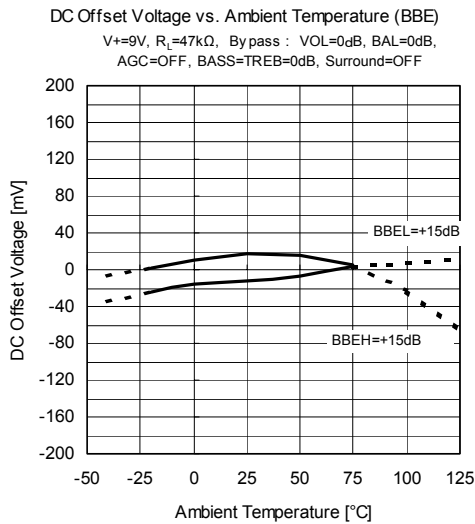
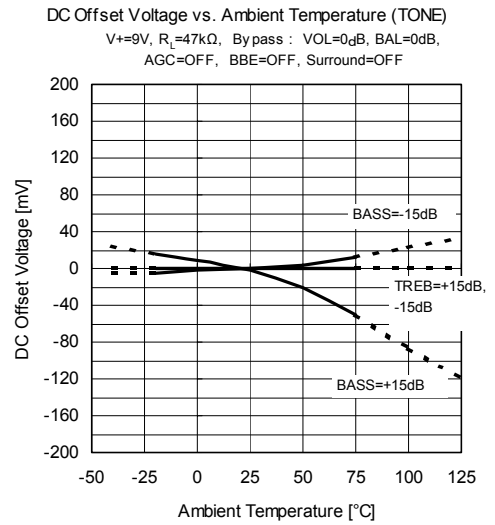
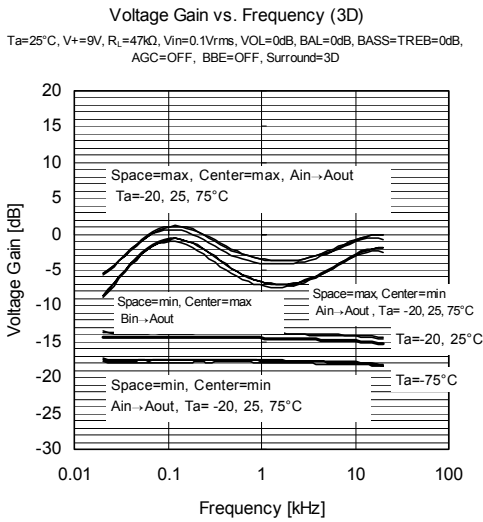

NOTE

The **NJW1148** is manufactured by New Japan Radio Co., Ltd. under license from BBE Sound Inc. BBE is a registered trademark of BBE Sound Inc. A license from BBE Sound Inc. is required before the **NJW1148** can be purchased from New Japan Radio Co.,Ltd.

BBE Sound, Inc.
5381 Production Drive
Huntington Beach, CA 92649
Tel:(714)897-6766
Fax:(714)896-0736

The TruSurround technology right incorporated in the **NJW1148** are owned by SRS Labs, a U.S. Corporation and licensed to New Japan Radio Co., Ltd. Purchaser of **NJW1148** must sign a license for use of the chip and display of the SRS Labs trademarks. Any products incorporating the **NJW1148** must be sent to SRS Labs for review. TruSurround is protected under U.S. and foreign patents issued and/or pending. TruSurround, SRS and the  symbol are trademarks of SRS Labs, Inc. in the United States and selected foreign countries. Neither the purchase of the **NJW1148**, nor the corresponding sale of audio enhancement equipment conveys the right to sell commercialized recordings made with any SRS technology.

SRS Labs requires all set makers to comply with all rules and regulations as outlined in the SRS Trademark Usage Manual separately provided.

For further information, please contact:
SRS Labs, Inc.
2909 Daimler Street. Santa Ana, CA 92705 USA
Tel: 949-442-1070 Fax: 949-852-1099 <http://www.srslabs.com>

Purchase of I²C components of New Japan Radio Co., Ltd or one of its sublicensed Associated Companies conveys a license under the Philips I²C Patent Rights to use these components in an I²C system, provided that the system conforms to the I²C Standard Specification as defined by Philips.

[CAUTION]

The specifications on this databook are only given for information, without any guarantee as regards either mistakes or omissions. The application circuits in this databook are described only to show representative usages of the product and not intended for the guarantee or permission of any right including the industrial rights.