

12-CHARACTER 2-LINE DOT MATRIX LCD CONTROLLER DRIVER

■ GENERAL DESCRIPTION

The NJU6428/29 is a Dot Matrix LCD controller driver for 12-character 2-line with icon display in single chip.

It contains voltage tripler, bleeder resistance, CR oscillator, microprocessor interface circuits, instruction decoder controller, character generator ROM/RAM, high voltage operation common and segment drivers.

The voltage tripler and bleeder resistance generates about triple voltage(8V) and bias voltage for LCD driving waveform internally from single power supply (3V). Consequently, high-contrast display can be performed though the simple power supply circuits.

The CR oscillator incorporates C and R, therefore no external components for oscillation are required.

The microprocessor interface circuits which operate by 1MHz, can be connected directly to 4/8bit microprocessor

The character generator consists of 9,600 bits ROM and 32 x 5 bits RAM.

The 17-common (16 for character, 1 for icon) and 60-segment drivers are operated up to 13.5V, and the icon common driver display up to 60 icons.

■ PACKAGE OUTLINE

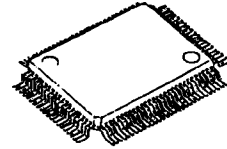

NJU6428X/29XFC1

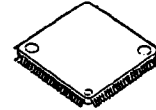

NJU6428X/29XFG1

5

■ FEATURES

- 12-character 2-line Dot Matrix LCD Controller Driver
- Maximum 60 icon Display (Using COMMK)
- 4/8 Bit Microprocessor Direct Interface
- Display Data RAM - 24 x 8 bits : Maximum 12-character 2-line Display
or 24-character 1-line Display
- Character Generator ROM - 9,600 bits : 240 Characters for 5 x 7 Dots
- Character Generator RAM - 32 x 5 bits : 4 Patterns (5 x 7 Dots)
- High Voltage LCD Driver : 17-common / 60-segment
- Maximum Display Character Number
(1/18 Duty, Icon Display Only for Version D and M is 2/18 Duty) :

Device	Display Character	Position of COMMK	Duty of COMMK	OP-AMP. Drive ability
NJU6428CX	12-Character 2-Line + Max.60 Icon Disp.	Upper Side	1/18	±5μA
NJU6428DX			2/18	
NJU6428LX			1/18	±10μA
NJU6428MX			2/18	
NJU6429CX		Lower Side	1/18	±5μA
NJU6429DX			2/18	
NJU6429LX	1/18		±10μA	
NJU6429MX	2/18			

- Useful Instruction Set : Clear Display, Return Home, Display ON/OFF Cont, Cursor ON/OFF Cont, Display Blink, Cursor Shift, Character Shift
- Power On Initialize / Hardware Reset Function
- Voltage Tripler and Bleeder Resistance On-chip
- Oscillation Circuit On-chip
- Low Power Consumption -- (100μA)
- Operating Voltage --- 2.4 to 3.6 V (Except LCD Driving Voltage)
- Package Outline --- Chip / Bumped Chip / QFP100-C1 / QFP100-G1(TGFP)
- C-NOS Technology

■ PIN CONFIGURATION (NJU6428FC1)

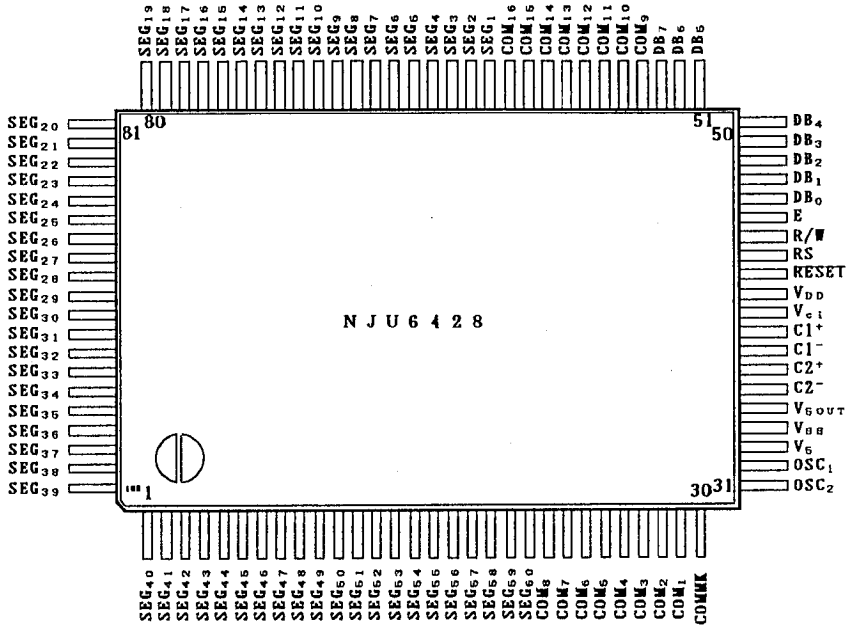

5

■ PIN CONFIGURATION (NJU6429FC1)

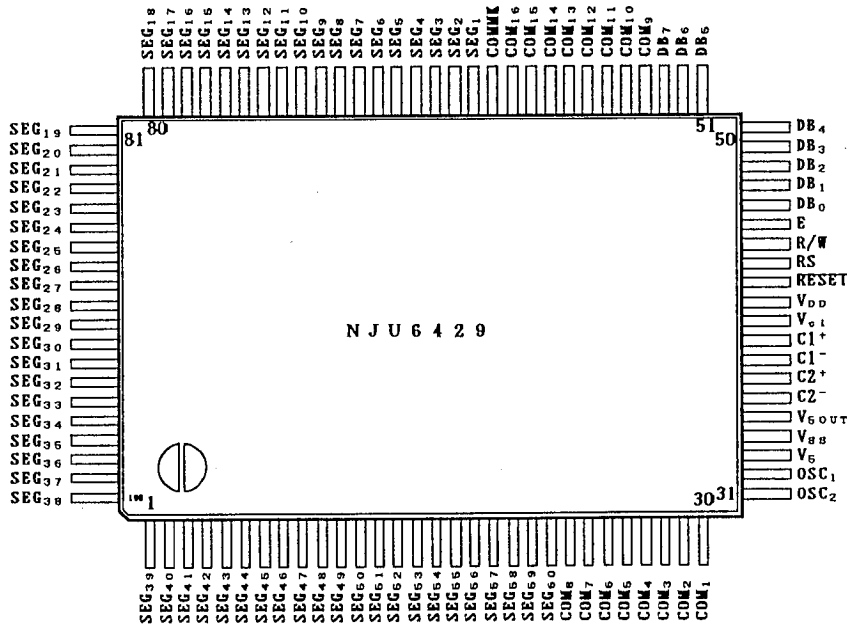

■ PIN CONFIGURATION (NJU6428FG1)

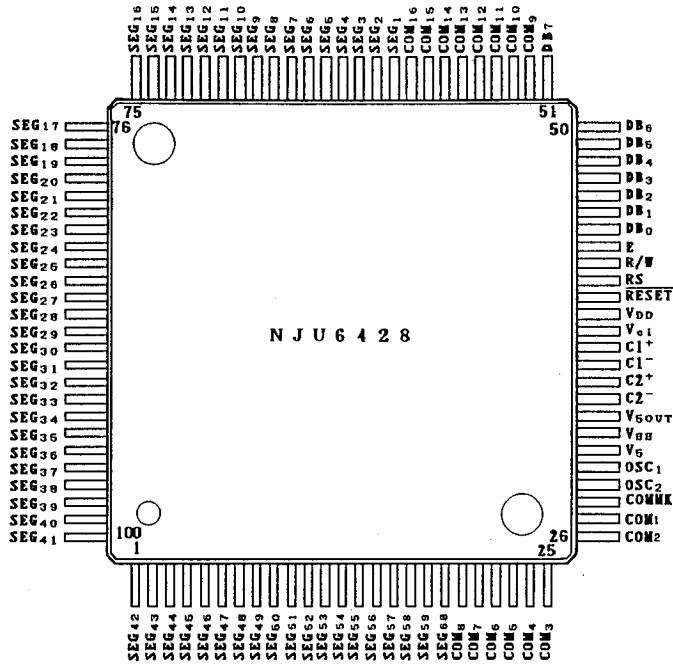

5

■ PIN CONFIGURATION (NJU6429FG1)

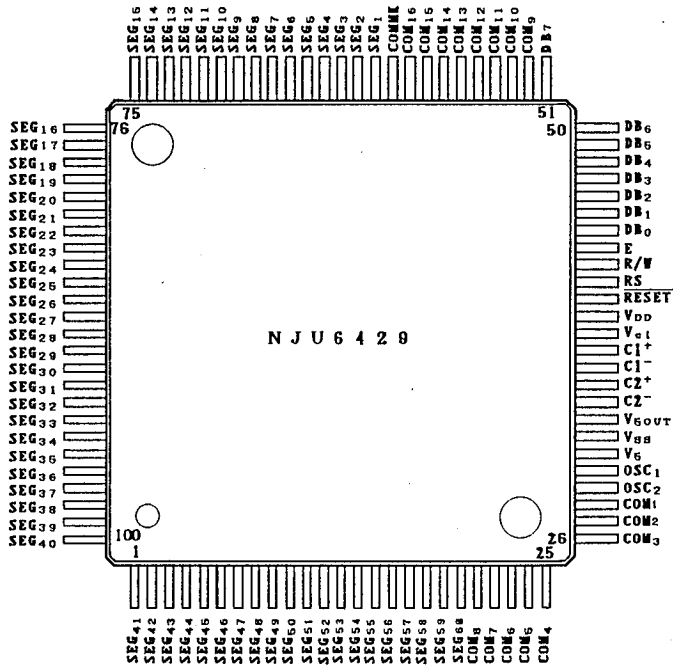

■ PAD LOCATION

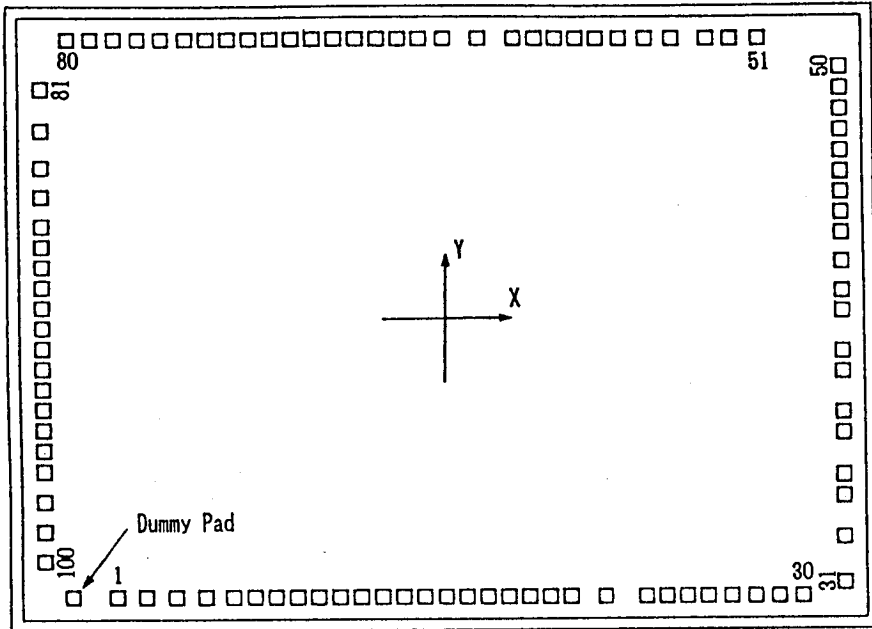

CHIP SIZE : 5.83mm x 4.23mm
CHIP CENTER : X=0 μ m, Y=0 μ m
PAD SIZE : 80 μ m x 80 μ m

■ PAD COORDINATES

 CHIP SIZE 5.83mm x 4.23mm (CHIP CENTER X=0 μ m, Y=0 μ m)

PAD No	PAD NAME		X=(μ m)	Y=(μ m)
	NJU6428	NJU6429		
1	SEG ₄₀	SEG ₃₉	-2199.0	-1894.0
2	SEG ₄₁	SEG ₄₀	-1999.0	-1894.0
3	SEG ₄₂	SEG ₄₁	-1799.0	-1894.0
4	SEG ₄₃	SEG ₄₂	-1599.0	-1894.0
5	SEG ₄₄	SEG ₄₃	-1419.0	-1894.0
6	SEG ₄₅	SEG ₄₄	-1279.0	-1894.0
7	SEG ₄₆	SEG ₄₅	-1139.0	-1894.0
8	SEG ₄₇	SEG ₄₆	- 999.0	-1894.0
9	SEG ₄₈	SEG ₄₇	- 859.0	-1894.0
10	SEG ₄₉	SEG ₄₈	- 719.0	-1894.0
11	SEG ₅₀	SEG ₄₉	- 579.0	-1894.0
12	SEG ₅₁	SEG ₅₀	- 439.0	-1894.0
13	SEG ₅₂	SEG ₅₁	- 299.0	-1894.0
14	SEG ₅₃	SEG ₅₂	- 159.0	-1894.0
15	SEG ₅₄	SEG ₅₃	- 19.0	-1894.0
16	SEG ₅₅	SEG ₅₄	121.0	-1894.0
17	SEG ₅₆	SEG ₅₅	261.0	-1894.0
18	SEG ₅₇	SEG ₅₆	401.0	-1894.0
19	SEG ₅₈	SEG ₅₇	541.0	-1894.0
20	SEG ₅₉	SEG ₅₈	681.0	-1894.0
21	SEG ₆₀	SEG ₅₉	821.0	-1894.0
22	COM ₈	SEG ₆₀	1058.0	-1894.0
23	COM ₇	COM ₈	1339.0	-1894.0
24	COM ₆	COM ₇	1479.0	-1894.0
25	COM ₅	COM ₆	1619.0	-1894.0
26	COM ₄	COM ₅	1759.0	-1894.0
27	COM ₃	COM ₄	1919.0	-1894.0
28	COM ₂	COM ₃	2079.0	-1894.0
29	COM ₁	COM ₂	2239.0	-1894.0
30	COMMK	COM ₁	2399.0	-1894.0
31	OSC ₂	OSC ₂	2688.0	-1806.0
32	OSC ₁	OSC ₁	2688.0	-1497.0
33	V ₅	V ₅	2688.0	-1220.0
34	V _{SS}	V _{SS}	2688.0	-1080.0
35	V _{5OUT}	V _{5OUT}	2688.0	- 801.0
36	C2 ⁻	C2 ⁻	2688.0	- 661.0
37	C2 ⁺	C2 ⁺	2688.0	- 382.0
38	C1 ⁻	C1 ⁻	2688.0	- 242.0
39	C1 ⁺	C1 ⁺	2688.0	38.0
40	V _{ci}	V _{ci}	2688.0	178.0
41	V _{DD}	V _{DD}	2688.0	378.0
42	RESET	RESET	2688.0	578.0
43	RS	RS	2688.0	718.0
44	R/W	R/W	2688.0	858.0
45	E	E	2688.0	998.0
46	DB ₀	DB ₀	2688.0	1138.0
47	DB ₁	DB ₁	2688.0	1278.0
48	DB ₂	DB ₂	2688.0	1418.0
49	DB ₃	DB ₃	2688.0	1558.0
50	DB ₄	DB ₄	2688.0	1698.0

PAD No	PAD NAME		X=(μ m)	Y=(μ m)
	NJU6428	NJU6429		
51	DB ₅	DB ₅	2134.0	1896.0
52	DB ₆	DB ₆	1944.0	1896.0
53	DB ₇	DB ₇	1784.0	1896.0
54	COM ₉	COM ₉	1547.0	1896.0
55	COM ₁₀	COM ₁₀	1367.0	1896.0
56	COM ₁₁	COM ₁₁	1187.0	1896.0
57	COM ₁₂	COM ₁₂	1027.0	1896.0
58	COM ₁₃	COM ₁₃	887.0	1896.0
59	COM ₁₄	COM ₁₄	747.0	1896.0
60	COM ₁₅	COM ₁₅	607.0	1896.0
61	COM ₁₆	COM ₁₆	467.0	1896.0
62	SEG ₁	COMMK	228.0	1896.0
63	SEG ₂	SEG ₁	- 3.0	1896.0
64	SEG ₃	SEG ₂	- 163.0	1896.0
65	SEG ₄	SEG ₃	- 303.0	1896.0
66	SEG ₅	SEG ₄	- 443.0	1896.0
67	SEG ₆	SEG ₅	- 583.0	1896.0
68	SEG ₇	SEG ₆	- 723.0	1896.0
69	SEG ₈	SEG ₇	- 863.0	1896.0
70	SEG ₉	SEG ₈	-1003.0	1896.0
71	SEG ₁₀	SEG ₉	-1143.0	1896.0
72	SEG ₁₁	SEG ₁₀	-1283.0	1896.0
73	SEG ₁₂	SEG ₁₁	-1423.0	1896.0
74	SEG ₁₃	SEG ₁₂	-1563.0	1896.0
75	SEG ₁₄	SEG ₁₃	-1703.0	1896.0
76	SEG ₁₅	SEG ₁₄	-1863.0	1896.0
77	SEG ₁₆	SEG ₁₅	-2023.0	1896.0
78	SEG ₁₇	SEG ₁₆	-2183.0	1896.0
79	SEG ₁₈	SEG ₁₇	-2343.0	1896.0
80	SEG ₁₉	SEG ₁₈	-2503.0	1896.0
81	SEG ₂₀	SEG ₁₉	-2688.0	1561.0
82	SEG ₂₁	SEG ₂₀	-2688.0	1281.0
83	SEG ₂₂	SEG ₂₁	-2688.0	1031.0
84	SEG ₂₃	SEG ₂₂	-2688.0	831.0
85	SEG ₂₄	SEG ₂₃	-2688.0	631.0
86	SEG ₂₅	SEG ₂₄	-2688.0	491.0
87	SEG ₂₆	SEG ₂₅	-2688.0	351.0
88	SEG ₂₇	SEG ₂₆	-2688.0	211.0
89	SEG ₂₈	SEG ₂₇	-2688.0	71.0
90	SEG ₂₉	SEG ₂₈	-2688.0	- 69.0
91	SEG ₃₀	SEG ₂₉	-2688.0	- 209.0
92	SEG ₃₁	SEG ₃₀	-2688.0	- 349.0
93	SEG ₃₂	SEG ₃₁	-2688.0	- 489.0
94	SEG ₃₃	SEG ₃₂	-2688.0	- 629.0
95	SEG ₃₄	SEG ₃₃	-2688.0	- 769.0
96	SEG ₃₅	SEG ₃₄	-2688.0	- 909.0
97	SEG ₃₆	SEG ₃₅	-2688.0	-1049.0
98	SEG ₃₇	SEG ₃₆	-2688.0	-1249.0
99	SEG ₃₈	SEG ₃₇	-2688.0	-1449.0
100	SEG ₃₉	SEG ₃₈	-2688.0	-1649.0

* The left side PAD of No1 PAD is Dummy PAD (Coordinates X=-2499,Y=-1894), No need Bonding.

■ BLOCK DIAGRAM

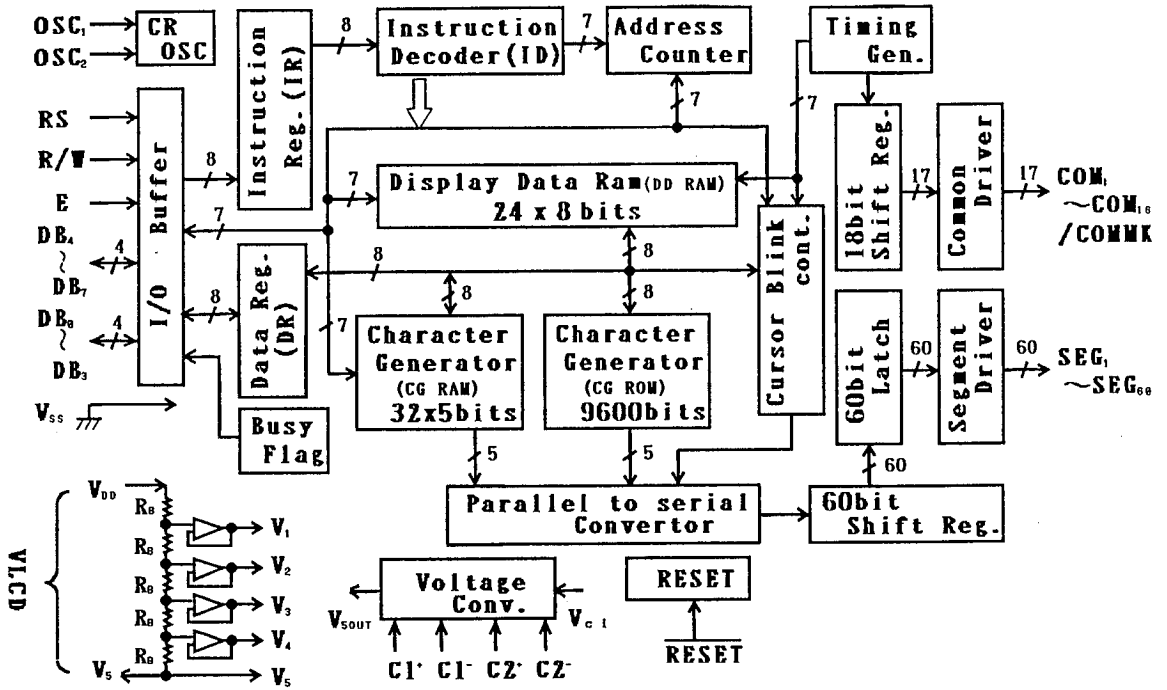

■ TERMINAL DESCRIPTION

NJU6428		SYMBOL	FUNCTION
PAD NO.			
FC1	FG1		
41	39	V_{DD}	Power Source (+ 3V)
34	32	V_{SS}	Power Source (0V)
33	31	V_5	LCD Driving Voltage Output
32 31	30 29	OSC ₁ OSC ₂	Oscillation Frequency Adjust Terminals. Normally Open. (Oscillation C and R are incorporated, Osc Frequency=80kHz) For external clock operation, the clock should be input on OSC ₁ .
43	41	RS	Register selection signal input(Pull-up resistance On-chip) "0" : Instruction Register (Writing) Busy Flag, Address Counter (Reading) "1" : Data Register (Writing/Reading)
44	42	R/W	Read/Write selection signal input(Pull-up Resistance On-chip) "0" : Write , "1" : Read
45	43	E	Read/Write activation signal input
50~53	48~51	DB ₄ ~DB ₇	3-state Data Bus(Upper) to transfer the data between MPU and NJU6428/29. DB ₇ is also used for the Busy Flag reading.
46~49	44~47	DB ₀ ~DB ₃	3-state Data Bus(Lower) to transfer the data between MPU and NJU6428/29. These bus are not used in the 4-bit operation.
29~22 54~61	27~20 52~59	COM ₁ ~COM ₁₆	LCD Common Driving Signal
30	28	COMMK	Icon Common Driving Signal
62~100 1 ~ 21	60~100 1 ~ 19	SEG ₁ ~SEG ₆₀	LCD Segment Driving Signal
39,37 38,36	37,35 36,34	C_1^+, C_2^+ C_1^-, C_2^-	Capacitor for Voltage Tripler Connecting Terminal (+) Capacitor for Voltage Tripler Connecting Terminal (-)
40	38	V_{ci}	Input Terminal for Voltage Tripler (Normally $V_{ci} = V_{DD}$)
35	33	V_{5OUT}	Voltage Tripler Output Terminal
42	40	RESET	Reset Terminal. When the "L" level input over 1.2ms to this terminal, the system will be reset($f_{osc}=80kHz$)

5

■ TERMINAL DESCRIPTION

NJU6429		SYMBOL	FUNCTION
PAD NO.			
FC1	FG1		
41	39	V _{DD}	Power Source (+ 3V)
34	32	V _{SS}	Power Source (0V)
33	31	V _S	LCD Driving Voltage Output
32 31	30 29	OSC ₁ OSC ₂	Oscillation Frequency Adjust Terminals. Normally Open. (Oscillation C and R are incorporated, Osc Frequency=80kHz) For external clock operation, the clock should be input on OSC ₁ .
43	41	RS	Register selection signal input(Pull-up resistance On-chip) "0" : Instruction Register (Writing) Busy Flag, Address Counter (Reading) "1" : Data Register (Writing/Reading)
44	42	R/W	Read/Write selection signal input(Pull-up Resistance On-chip) "0" : Write , "1" : Read
45	43	E	Read/Write activation signal input
50~53	48~51	DB ₄ ~DB ₇	3-state Data Bus(Upper) to transfer the data between MPU and NJU6428/29. DB ₇ is also used for the Busy Flag reading.
46~49	44~47	DB ₀ ~DB ₃	3-state Data Bus(Lower) to transfer the data between MPU and NJU6428/29. These bus are not used in the 4-bit operation.
30~23 54~61	28~21 52~59	COM ₁ ~COM ₁₆	LCD Common Driving Signal
62	60	COMMK	Icon Common Driving Signal
63~100 1 ~ 22	61~100 1 ~ 20	SEG ₁ ~SEG ₆₀	LCD Segment Driving Signal
39,37 38,36	37,35 36,34	C ₁ ⁺ , C ₂ ⁺ C ₁ ⁻ , C ₂ ⁻	Capacitor for Voltage Tripler Connecting Terminal (+) Capacitor for Voltage Tripler Connecting Terminal (-)
40	38	V _{ci}	Input Terminal for Voltage Tripler (Normally V _{ci} = V _{DD})
35	33	V _{SOUT}	Voltage Tripler Output Terminal
42	40	RESET	Reset Terminal. When the "L" level input over 1.2ms to this terminal, the system will be reset(f _{osc} =80kHz)

■ FUNCTIONAL DESCRIPTION

(1) Description for each blocks

(1-1) Register

The NJU6428/29 incorporates two 8-bit registers, an Instruction Register (IR) and a Data Register (DR). The Register (IR) stores instruction codes such as "Clear Display" and "Return Home", and address data for Display Data RAM (DD RAM) and Character Generator RAM (CG RAM).

The MPU can write the instruction code and address data to the Register (IR), but it cannot read out from the Register (IR).

The Register (DR) is a temporary stored register, the data stored in the Register (DR) is written into the DD RAM or CG RAM and read out from the DD RAM or CG RAM.

The data in the Register (DR) written by the MPU is transferred automatically to the DD RAM or CG RAM by internal operation.

When the address data for the DD RAM or CG RAM is written into the Register (IR), the addressed data in the DD RAM or CG RAM is transferred to the Register (DR). By the MPU read out the data in the Register (DR), the data transmitting process is performed completely.

After reading the data in the Register (DR) by the MPU, the next address data in the DD RAM or CG RAM is transferred automatically to the Register (DR) to provide for the next MPU reading.

These two registers are selected by the selection signal RS as shown below.

Table 1. shows register operation controlled by RS and R/W signals.

Table 1. Register Operation

RS	R/W	Selected Register	Operation
0	0	IR	Write
0	1		Read busy flag (DB ₇) and address counter (DB ₀ ~DB ₆)
1	0	DR	Write (Register (DR) to DD RAM or CG RAM)
1	1		Read (DD RAM or CG RAM to Register (DR))

(1-2) Busy Flag (BF)

When the internal circuits are in the operation mode, the busy flag (BF) is "1", and any instruction reading is inhibited.

The busy flag (BF) is output at DB₇ when RS="0" and R/W="1" as shown in Table 1.

The next instruction should be written after the busy flag (BF) goes to "0".

(1-3) Address Counter (AC)

The address counter (AC) addressing the DD RAM and CG RAM.

When the address setting instruction is written into the Register (IR), the address information is transferred from Register (IR) to the Counter (AC). The selection of either the DD RAM or CG RAM is also determined by this instruction.

After writing (or reading) the display data to (or from) the DD RAM or CG RAM, the Counter (AC) increments (or decrements) automatically.

The address data in the Counter (AC) is output from DB₆~DB₀ when RS="0" and R/W="1" as shown in Table 1.

(1-4) Display Data RAM (DD RAM)

The display data RAM (DD RAM) consists of 24 x 8 bits stores up to 24-character display data represented in 8-bit code.

The DD RAM address data set in the address counter(AC) is represented in Hexadecimal.

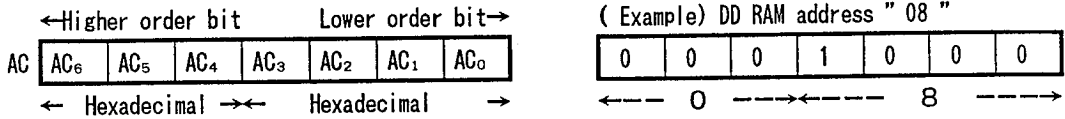

(1-4-1) 1-line Display (N=0)

The relation between DD RAM address and display position on the LCD is shown below.

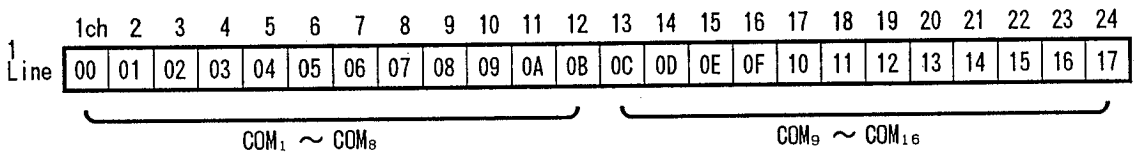

When the display shift is performed, the DD RAM address changes as follows:

(Left Shift Display)

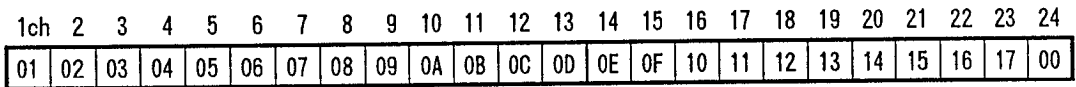

(Right Shift Display)

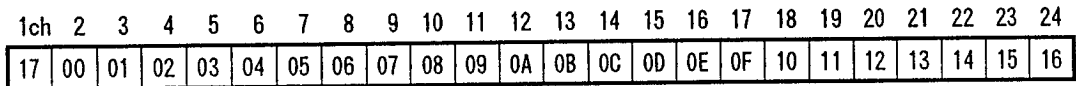

(1-4-2) 2-line Display (N=1)

The relation between DD RAM address and display position on the LCD is shown below.

		COM ₁ ~ COM ₈												
		1	2	3	4	5	6	7	8	9	10	11	12	← Display Position
1st Line		00	01	02	03	04	05	06	07	08	09	0A	0B	
2nd Line		40	41	42	43	44	45	46	47	48	49	4A	4B	← DD RAM Address (Hexadecimal)
		COM ₉ ~ COM ₁₆												

Note : In the 2 lines display mode, the 1st and 2nd line address are defined as (00)_H to (0B)_H and (40)_H to (4B)_H. Please note that the end of 1st line address and the beginning of 2nd line address are not consecutive.

When the display shift is performed, the DD RAM address changes as follows:

(Left Shift Display)

		1	2	3	4	5	6	7	8	9	10	11	12
(00)←		01	02	03	04	05	06	07	08	09	0A	0B	00
(40)←		41	42	43	44	45	46	47	48	49	4A	4B	40

(Right Shift Display)

		1	2	3	4	5	6	7	8	9	10	11	12	
		0B	00	01	02	03	04	05	06	07	08	09	0A	→(0B)
		4B	40	41	42	43	44	45	46	47	48	49	4A	→(4B)

(1-5) Character Generator ROM (CG ROM)

The Character Generator ROM (CG ROM) generates 5 x 7 dots character pattern represented in 8-bit character codes.

The storage capacity is up to 240 kinds of 5 x 7 dots character pattern.

The correspondence between character code and standard character pattern of NJU6428/29 is shown in Table 2-1 and 2-2.

User-defined character patterns (Custom Font) are also available by mask option.

Table 2-1. CG ROM Character Pattern (ROM version -02)

		Upper 4 bit (Hexadecimal)															
		0	1	2	3	4	5	6	7	8	9	A	B	C	D	E	F
Lower 4 bit (Hexadecimal)	0	CG RAM (01)	␣	␣	␣	␣	␣	␣	␣	␣	␣	␣	␣	␣	␣	␣	␣
	1	(02)	␣	!	1	A	0	a	9	0	a	a	7	7	4	a	q
	2	(03)	␣	"	2	B	R	b	r	e	E	"	7	7	7	8	8
	3	(04)	␣	#	3	C	S	c	s	a	0	u	7	7	e	e	w
	4	(01)	␣	\$	4	D	T	d	t	a	0	u	7	7	7	7	0
	5	(02)	␣	%	5	E	U	e	u	a	0	u	7	7	7	7	0
	6	(03)	␣	&	6	F	V	f	v	0	7	7	7	7	7	7	7
	7	(04)	␣	'	7	G	W	w	g	0	7	7	7	7	7	7	7
	8	(01)	␣	(8	H	X	h	x	0	7	7	7	7	7	7	7
	9	(02)	␣)	9	I	Y	i	y	0	7	7	7	7	7	7	7
	A	(03)	␣	*	␣	J	Z	j	z	0	7	7	7	7	7	7	7
	B	(04)	␣	+	␣	K	␣	k	␣	0	7	7	7	7	7	7	7
	C	(01)	␣	,	␣	L	␣	l	␣	0	7	7	7	7	7	7	7
	D	(02)	␣	-	␣	M	␣	m	␣	0	7	7	7	7	7	7	7
	E	(03)	␣	.	␣	N	␣	n	␣	0	7	7	7	7	7	7	7
	F	(04)	␣	/	␣	O	␣	o	␣	0	7	7	7	7	7	7	7

Table 2-2. CG ROM Character Pattern (ROM version -05)

		Upper 4 bit (Hexadecimal)															
		0	1	2	3	4	5	6	7	8	9	A	B	C	D	E	F
Lower 4 bit (Hexadecimal)	0	⬆		0	aP	`	P	...	⊗		—	9	Σ	0	⊙		
	1	⬆	!	1	A0	a	9	...	0	.	7	7	4	8	⊗		
	2	⬆	"	2	BR	b	r	...	0	'	イ	ツ	ノ	ノ	⊗		
	3	⬆	#	3	C5	c	s	...	0	.	ウ	7	ε	π	π		
	4	⬆	\$	4	DT	d	t	\	エ	ト	ト	Σ	火		
	5	⬆	%	5	EU	e	u	...	±	.	オ	+	1	ε	*		
	6	⬆	&	6	FV	f	v	...	×	ヲ	カ	ニ	ヨ	ノ	*		
	7	⬆	'	7	GW	g	w	...	÷	7	7	ヲ	ヲ	ε	Σ		
	8	⬆	(8	HX	h	x	...	×	ノ	ク	ヲ	リ	Σ	Σ		
	9	⬆)	9	IY	i	y	...	±	ノ	ク	ヲ	リ	Σ	Σ		
	A	⬆	*	:	JZ	j	z	...	±	エ	コ	ノ	ノ	ε	7		
	B	⬆	+	:	KE	k	e	...	±	ノ	ク	ヲ	リ	Σ	Σ		
	C	⬆	,	<	L#	l	#	...	±	ノ	ク	ヲ	リ	Σ	Σ		
	D	⬆	—	=	MJ	m	j	...	±	ノ	ク	ヲ	リ	Σ	Σ		
	E	⬆	.	>	N^	n	^	...	±	ノ	ク	ヲ	リ	Σ	Σ		
	F	⬆	/	?	O_	o	_	...	±	ノ	ク	ヲ	リ	Σ	Σ		

5

(1-6) Character Generator RAM (CG RAM)

The character generator RAM (CG RAM) can store any kind of character pattern in 5 x 7 dots written by the user program to display user's original character pattern and icon data. The CG RAM can store 4 kind of character in 5 x 7 dots mode or 2 kind of character in 5 x 7 dots mode and icon data.

To display user's original character pattern stored in the CG RAM, the address data (00)_H - (03)_H should be written to the DD RAM as shown in Table 2-1 and 2-2.

Table 3. show the correspondence among the character pattern, CG RAM address and Data.

Table 3. Correspondence of CG RAM address, DD RAM character code and CG RAM character pattern(5 x 7 dots).

Character Code (DD RAM Data)	CG RAM Address	Character Pattern (CG RAM Data)
7 6 5 4 3 2 1 0 ←-----→ Upper bit Lower bit	4 3 2 1 0 ←-----→ Upper bit Lower bit	←-----→ 4 3 2 1 0 Upper bit Lower bit
0 0 0 0 * * 0 0	0 0	
0 0 0 0 * * 0 1	0 1	
0 0 0 0 * * 1 1	1 1	

Character Pattern Example(1)
←Cursor Position

Character Pattern Example(2)
←Cursor Position

* : Don't Care

- Notes :
- Character code bit 0, 1 correspond to the CG RAM address 3, 4(2bits:4 patterns).
 - CG RAM address 0 to 2 designate character pattern line position. The 8th line is the cursor position and the display is performed by logical OR with cursor. Therefore, in case of the cursor display, the 8th line should be "0". If there is "1" in the 8th line, the bit "1" is always displayed on the cursor position regardless of cursor existence.
 - Character pattern row position correspond to the CG RAM data bits 0 to 4 are shown above.
 - CG RAM character patterns are selected when character code bits 4 to 7 are all "0" and it is addressed by character code bits 0 and 1. Therefore, the address (00)_H, (04)_H, (08)_H and (0C)_H select the same character pattern as shown in Table 2-1, 2-2 and Table 3.
 - "1" for CG RAM data corresponds to display On and "0" to display Off.
 - CG RAM address (14)_H to (1F)_H are using for both of character pattern memory and

(1-7) Icon Display Function

The NJU6428/29 can display not only 5 x 7 bits character pattern but also maximum 60 icons. The icon can be displayed by writing bit "1" to each data bit 0 to 4 in the address (14)_H ~ (1F)_H of CG RAM.

The fixed character display code is not affected except CG RAM writing and display ON/OFF instruction.

The relation between CG RAM address and icon display position on the LCD is fixed even if the display shift is executed. The relation is shown below:

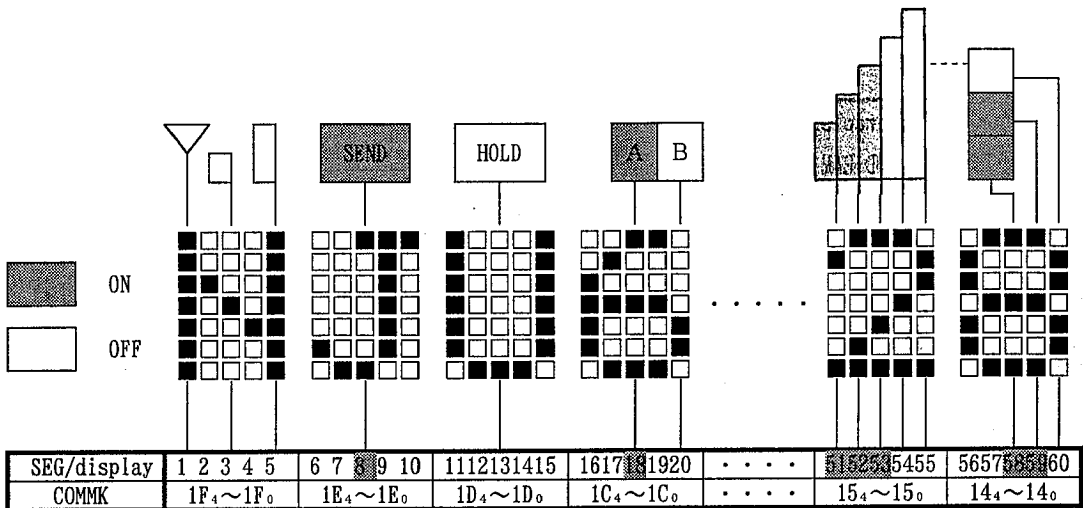

NOTE) The 1F₄ corresponds bit 4 of (1F)_H in CG RAM.

< CG RAM vs. SEG terminal
for icon display >

CG RAM address	data 43210	SEG terminal
14	00110	56~60
15	11100	51~55
16	46~50
17	41~45
18	36~40
19	31~35
1A	26~30
1B	21~25
1C	00100	16~20
1D	00000	11~15
1E	00100	6~10
1F	00000	1~5

Maximum Character Number and Icon Display Number in CG RAM

Icon Disp. Number	Max. Chara. Number	Note
No Use	4 Chara.	
40 Icons	3 Chara.	(03) _H , (07) _H , (0B) _H and (0F) _H can not use for Character Memory.
60 Icons	2 Chara.	(02) _H , (03) _H , (06) _H , (07) _H , (0A) _H , (0B) _H , (0E) _H and (0F) _H can not use for Character Memory.

NOTE) When the icon display function using, the system should be initialized by the software initialization because of the CG RAM does not initialize except the software initialization.

(1-8) Timing Generator

The timing generator generates a timing signals for the DD RAM, CG RAM, CG ROM and other internal circuits operation.

RAM read timing for the display and internal operation timing for MPU access are separately generated, so that they may not interfere with each other.

Therefore, when the data write to the DD RAM for example, there will be no undesirable influence, such as flickering, in areas other than the display area.

(1-9) LCD Driver

LCD driver consist of 17-common driver and 60-segment driver.

When the line number is selected by a program, the required common drivers output the common driving waveform and the other common drivers output non-selection waveform automatically.

The 60 bits of character pattern data are shifted in the shift-register and latched when the 60 bits shift performed completely. This latched data controls display driver to output LCD driving waveform.

(1-10) Cursor Blinking Control Circuit

This circuits controls cursor On/Off and the cursor position character blinks.

The cursor or blinks appear in the digit residing at the DD RAM address set in the address counter (AC).

When the address counter is $(08)_H$, a cursor position is shown as follows:

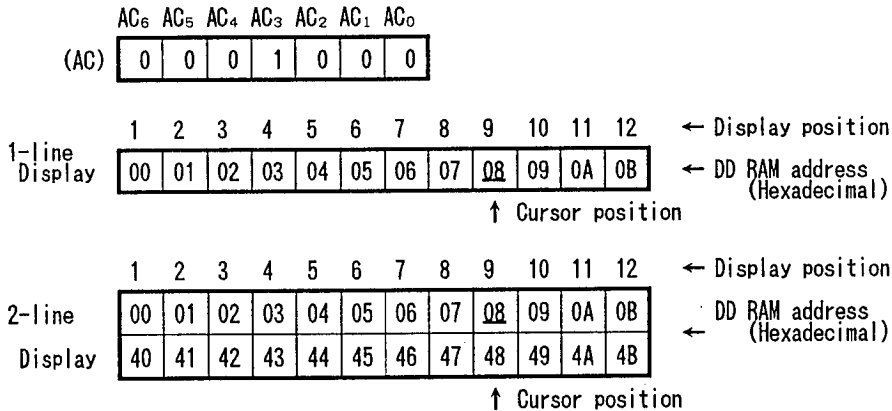

(Note) The cursor or blinks also appear when the address counter (AC) selects the CG RAM. But the displayed cursor and blink are meaningless.

If the AC storing the CG RAM address data, the cursor and blink are displayed in the meaningless position.

(2) Power on Initialization by internal circuits

(2-1) Initialization By Internal Reset Circuit

The NJU6428/29 is automatically initialized by internal power on initialization circuits when the power is turned on. In the internal power on initialization, following instructions are executed. During the Internal power on initialization, the busy flag (BF) is "1" and this status is kept 10 ms after V_{DD} rises to 2.4V.

Initialization flow is shown below:

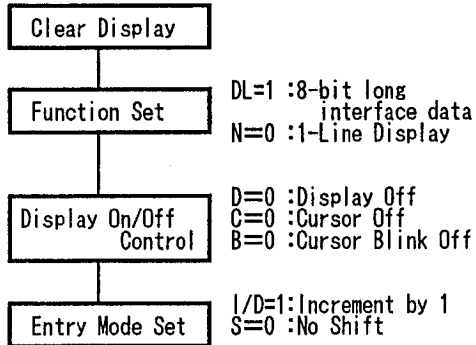

NOTE
If the condition of power supply rise time described in the Electrical Characteristics is not satisfied, the internal Power On Initialization Circuits will not operated and initialization will not performed.
In this case the initialization by MPU software is required.

(2-2) Initialization By Hardware

The NJU6428/29 incorporates $\overline{\text{RESET}}$ terminal to initialize the all system. When the "L" level input over 1.2ms to the $\overline{\text{RESET}}$ terminal, reset sequence is executed. In this time, busy signal output during 10ms after $\overline{\text{RESET}}$ terminal goes to "H".

• Reset Circuit

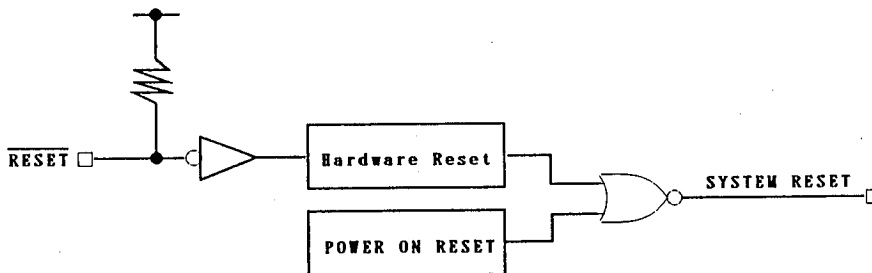

• Timing Chart

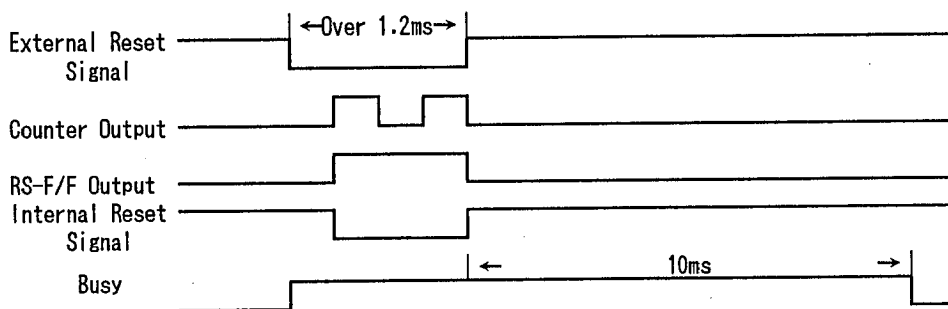

(3) Instructions

The NJU6428/29 incorporates two registers, an Instruction Register (IR) and a Data Register (DR).

These two registers store control information temporarily to allow interface between NJU6428/29 and MPU or peripheral ICs operating different cycles. The operation of NJU6428/29 is determined by this control signal from MPU. The control information includes register selection signals (RS), read/write signals (R/W) and data bus signals (DB_0 to DB_7).

Table 4. shows each instruction and its operating time.

Note 1) The execution time mentioned in Table 4. based on f_{cp} or $f_{osc}=80\text{kHz}$.

If the oscillation frequency is changed, the execution time is also changed.

Note 2) When the reset function is executed, 24-character 1-line is selected.

Table 4. Table of Instructions

INSTRUCTIONS	C O D E										DESCRIPTION	EXEC TIME
	RS	R/W	DB ₇	DB ₆	DB ₅	DB ₄	DB ₃	DB ₂	DB ₁	DB ₀		
Maker Testing	0	0	0	0	0	0	0	0	0	0	All "0" code is using for maker testing.	—
Clear Display	0	0	0	0	0	0	0	0	0	1	Display clear and sets DD RAM address 0 in AC.	1.63ms
Return Home	0	0	0	0	0	0	0	0	1	*	Sets DD RAM address 0 in AC and returns display being shifted to original position. DD RAM contents remain unchanged	125us
Entry Mode Set	0	0	0	0	0	0	0	1	I/D	S	Sets cursor move direction and specifies shift of display are performed in data read/write. I/D=1: Increment, I/D=0: Decrement S=1: Accompanies display shift	125us
Display On/Off Control	0	0	0	0	0	0	1	D	C	B	Sets of display On/Off(D), cursor On/Off(C) and blink of cursor position character(B).	125us
Cursor or Display Shift	0	0	0	0	0	1	S/C	R/L	*	*	Moves cursor and shifts display without changing DD RAM contents S/C=1 : Display shift S/C=0 : Cursor shift R/L=1 : Shift to the right R/L=0 : Shift to the left	188us
Function Set	0	0	0	0	1	DL	N	*	*	*	Sets interface data length(DL), number of display lines(N) and display character number. Character font is fixed 5 X 7. DL=1 : 8 bits , DL=0 : 4 bits N=1 : 2-line , N=0 : 1-line	125us
Set CG RAM Address	0	0	0	1	*	←← A _{CG} →→				Sets CG RAM address. After this instruction, the data is transferred to/from CG RAM.	125us	
Set DD RAM Address	0	0	1	←←			A _{DD}	→→			Sets DD RAM address. After this instruction, the data is transferred to/from DD RAM.	125us
Read Busy Flag & Address	0	1	BF	←←			AC	→→			Reads busy flag and AC contents. BF=1 : Internally operating BF=0 : Can accept instruction	0us
Write Data to CG & DD RAM	1	0	←← Write Data(DD RAM) →→			* * * ←←(CG RAM) →→					Writes data into DD or CG RAMs.	125us
Read Data from CG or DD RAM	1	1	←← Read Data(DD RAM) →→			* * * ←←(CG RAM) →→					Reads data from DD or CG RAMs.	188us
Explanation of Abbreviation	DD RAM : Display data RAM , CG RAM : Character generator RAM A _{CG} : CG RAM address , A _{DD} : DD RAM address, Corresponds to cursor address AC : Address counter used for both of DD and CG RAMs											

5

(3-1) Description of each instructions

(a) Maker Testing

	RS	R/W	DB ₇	DB ₆	DB ₅	DB ₄	DB ₃	DB ₂	DB ₁	DB ₀
Code	0	0	0	0	0	0	0	0	0	0

All "0" code in 4-bit length is using for device testing mode (only for maker). Therefore, please avoid all "0" input or no meaning Enable signal input at data "0". (Especially please pay attention the output condition of Enable signal when the power turns on.)

(b) Clear Display

	RS	R/W	DB ₇	DB ₆	DB ₅	DB ₄	DB ₃	DB ₂	DB ₁	DB ₀
Code	0	0	0	0	0	0	0	0	0	1

Clear display instruction is executed when the code "1" is written into DB₀. When this instruction is executed, the space code (20)_H is written into every DD RAM address, the DD RAM address 0 is set into the address counter and entry mode is set increment. If the cursor or blink are displayed, they are returned to the left end of the LCD (the left end of the 1st line in the 2-line display mode).

The S of entry mode does not change.

Note: The character pattern for character code (20)_H must be blank code in the user-defined character pattern(Custom font).

(c) Return Home

	RS	R/W	DB ₇	DB ₆	DB ₅	DB ₄	DB ₃	DB ₂	DB ₁	DB ₀	
Code	0	0	0	0	0	0	0	0	1	*	* = Don't care

Return home instruction is executed when the code "1" is written into DB₁. When this instruction is executed, the DD RAM address 0 is set into the address counter. Display is returned its original position if shifted, the cursor or blink are returned to the left end of the LCD (the left end of the 1st line in the 2-line display mode) if the cursor or blink are on the display.

The DD RAM contents do not change.

(d) Entry Mode Set

	RS	R/W	DB ₇	DB ₆	DB ₅	DB ₄	DB ₃	DB ₂	DB ₁	DB ₀
Code	0	0	0	0	0	0	0	1	I/D	S

Entry mode set instruction which sets the cursor moving direction and display shift On/Off, is executed when the code "1" is written into DB₂ and the codes of (I/D) and (S) are written into DB₁(I/D) and DB₀(S), as shown below.

(I/D) sets the address increment or decrement, and the (S) sets the entire display shift in the DD RAM writing.

I/D	F u n c t i o n
1	Address increment: The address of the DD RAM or CG RAM increment (+1) when the read/write, and the cursor or blink move to the right.
0	Address decrement: The address of the DD RAM or CG RAM decrement (-1) when the read/write, and the cursor or blink move to the left.
S	F u n c t i o n
1	Entire display shift. The shift direction is determined by I/D. : shift to the left at I/D=1 and shift to the right at the I/D=0. The shift is operated only for the character, so that it looks as if the cursor stands still and the display moves. The display does not shift when reading from the DD RAM and writing/reading into/from CG RAM.
0	The display does not shifting.

(e) Display On/Off Control

	RS	R/W	DB ₇	DB ₆	DB ₅	DB ₄	DB ₃	DB ₂	DB ₁	DB ₀
Code	0	0	0	0	0	0	1	D	C	B

Display On/Off control instruction which controls the whole display On/Off, the cursor On/Off and the cursor position character blink, is executed when the code "1" is written into DB₃ and the codes of (D), (C) and (B) are written into DB₂(D), DB₁(C) and DB₀(B), as shown below.

D	F u n c t i o n
1	Display On.
0	Display Off. In this mode, the display data remains in the DD RAM so that it is retrieved immediately on the display when the D change to 1.

C	F u n c t i o n
1	Cursor On. The cursor is displayed by 5 dots on the 8th line.
0	Cursor Off. Even if the display data write, the I/D etc does not change.

B	F u n c t i o n
1	The cursor position character is blinking. Blinking rate is 540ms at $f_{osc}=80kHz$ for 12-character 2-line. The cursor and the blink can be displayed simultaneously.
0	The character does not blink.

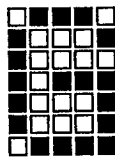
 ↑
Cursor

Character Font 5 x 7 dots

(1) Cursor display example

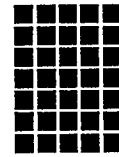
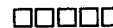
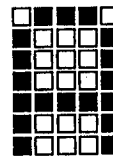

Alternating display

(2) Blink display example

(f) Cursor/Display Shift

	RS	R/W	DB ₇	DB ₆	DB ₅	DB ₄	DB ₃	DB ₂	DB ₁	DB ₀	
Code	0	0	0	0	0	1	S/C	R/L	*	*	* = Don't care

The Cursor/Display shift instruction shifts the cursor position or display to the right or left without writing or reading display data. This function is used to correct or search the display. In the 2-line display, the cursor moves to the 2nd line when it passes the 12th digit of the 1st line. Notice that the 1st and 2nd line displays will shift at the same time. When the displayed data is shifted repeatedly, each line moves only horizontally.

The 2nd line display does not shift into the 1st line position.

The contents of address counter(AC) does not change by operation of the display shift only.

This instruction is executed when the code "1" is written into DB₄ and the codes of (S/C) and (R/L) are written into DB₃(S/C) and DB₂(R/L), as shown below.

S/C	R/L	F u n c t i o n
0	0	Shifts the cursor position to the left ((AC) is decremented by 1)
0	1	Shifts the cursor position to the right ((AC) is incremented by 1)
1	0	Shifts the entire display to the left and the cursor follows it.
1	1	Shifts the entire display to the right and the cursor follows it.

(g) Function Set

	RS	R/W	DB ₇	DB ₆	DB ₅	DB ₄	DB ₃	DB ₂	DB ₁	DB ₀	
Code	0	0	0	0	1	DL	N	*	*	*	* = Don't care

Function set instruction which sets the interface data length and number of display lines, is executed when the code "1" is written into DB₅ and the codes of (DL) and (N) are written into DB₄(DL) and DB₃(N), as shown below (character font is fixed 5 x 7 dots).

(DL) sets the interface data length and (N) sets the number of display lines either the 1-line or 2-line.

NOTE

This function set instruction must be performed at the head of the program prior to all other existing instructions(except Busy flag/Address read). This function set instruction can not be executed afterwards unless the interface data length change.

DL	F u n c t i o n
1	Set the interface data length to 8 bits (DB ₇ to DB ₀)
0	Set the interface data length to 4 bits (DB ₇ to DB ₄) The data must be sent or received twice in this mode.

N	Display lines	Display Digit
0	1-line	24 Character
1	2-line	12 Character

(h) Set CG RAM Address

	RS	R/W	DB ₇	DB ₆	DB ₅	DB ₄	DB ₃	DB ₂	DB ₁	DB ₀	
Code	0	0	0	1	*	A	A	A	A	A	* = Don't care
	←Higher order bit					Lower order bit→					

Set CG RAM address set instruction is executed when the code "1" is written into DB₆ and the address is written into DB₅ to DB₀ as shown above.

The address data mentioned by binary code "AAAAA" is written into the address counter (AC) together with the CG RAM addressing condition. After this instruction execution, the data writing/reading is performed into/from the CG RAM.

(i) Set DD RAM Address

	RS	R/W	DB ₇	DB ₆	DB ₅	DB ₄	DB ₃	DB ₂	DB ₁	DB ₀
Code	0	0	1	A	A	A	A	A	A	A
	←Higher order bit					Lower order bit→				

Set DD RAM address instruction is executed when the code "1" is written into DB₇ and the address is written into DB₆ to DB₀ as shown above.

The address data mentioned by binary code "AAAAAAA" is written into the address counter (AC) together with the DD RAM addressing condition. After this instruction execution, the data writing/reading is performed into/from the DD RAM.

Note : In case of the 1-line display(N=0), the address data is (00)_H to (17)_H.

And the 2-line display(N=1), the [AAAAAAA] is (00)_H to (0B)_H for the 1st line AND (40)_H to (4B)_H for the 2nd line.

(j) Read Busy Flag & Address

	RS	R/W	DB ₇	DB ₆	DB ₅	DB ₄	DB ₃	DB ₂	DB ₁	DB ₀
Code	0	1	BF	A	A	A	A	A	A	A
	←Higher order bit					Lower order bit→				

This instruction reads out the internal status of the NJU6428/29. When this instruction is executed, the busy flag (BF) which indicate internal operation is read out from DB₇ and the address of the CG RAM or DD RAM is read out from DB₆ to DB₀ (the address for the CG RAM or DD RAM is determined by the previous instruction).

(BF)="1" indicates that internal operation is in progress. The next instruction is inhibited when (BF)="1". Check the (BF) status before the next write operation.

(k) Write Data to CG RAM or DD RAM

• Write Data to DD RAM

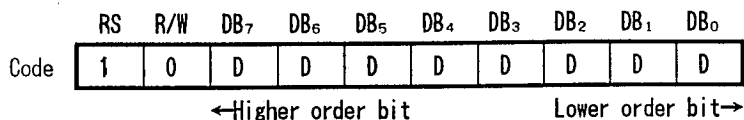

Write Data to DD RAM instruction is executed when the code "1" is written into (RS) and code "0" is written into (R/W).

By the execution of this instruction, the binary 8 bit data "DDDDDDDD" are written into the DD RAM. The selection of the DD RAM is determined by the previous instruction (DD RAM must be selected before). After this instruction execution, the address increment(+1) or decrement (-1) is performed automatically according to the entry mode set. And the display shift is also executed according to the previous entry mode set.

• Write Data to CG RAM

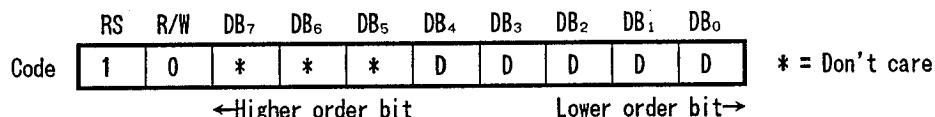

Write Data to CG RAM instruction is executed when the code "1" is written into (RS) and code "0" is written into (R/W).

By the execution of this instruction, the binary 5 bit data "DDDDD" are written into the CG RAM. The selection of the CG RAM is determined by the previous instruction (CG RAM must be selected before). After this instruction execution, the address increment(+1) or decrement (-1) is performed automatically according to the entry mode set. And the display shift is also executed according to the previous entry mode set.

(3-2) Initialization using the internal reset circuits

(a) 24-character 1-line display in 8-bit operation (Using internal reset circuits).

At the 24-character 1-line display, the Function set, Display On/Off Control and Entry Set Instruction must be executed before the data input, as shown below.

The DD RAM of the NJU6428/29 can store up to 24 characters, as explained before, therefore the advertising moving display is available when combined with the display shift operation.

Since the display shift operation changes only display position and the DD RAM contents remain unchanged, display data which are entered first can be output when the return home operation is performed.

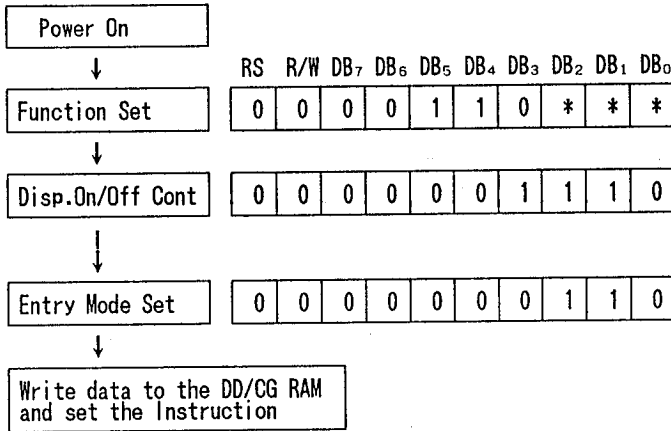

Initialized.
No display appears.

Set the 8-bit operation, 24-character 1-line display, 5 x 7 dots Font.

Turns on display and cursor. Entire display is in space mode set by the initialization.

Example for set address increment and cursor right shift when the data write to the DD RAM or CG RAM.

(b) 24-character 1-line in 4-bit operation (Using internal reset circuits).

In the 4-bit operation, the function set must be performed by the user programming.

When the power is turned on, 8-bit operation is selected automatically, therefore the first input is performed under 8-bit operation. In this operation, full instruction can not input because of terminals DB₀ to DB₃ are no connection. Therefore, same instruction must be rewritten on the RS, R/W and DB₇ to DB₄, as shown below. Since one operation is completed by the two accesses in the 4-bit operation mode, rewrite is required to set the instruction code in full.

16-character 2-line in 4-bit operation is shown as follows:

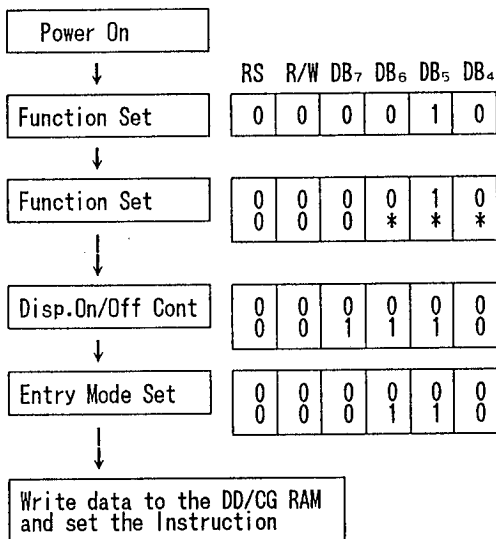

Initialized.
No display appears.

Set the 4-bit operation.
This step is executed in 8-bit mode set by the initialization.

Set the 4-bit operation 24-character 1-line display, 5 x 7 dots Font.
The 4-bit operation starts from this step.

Turn on display and cursor.
Entire display is in space mode set by the initialization.

Example for set address increment and cursor right shift when the data write to the DD RAM or CG RAM.

5

(c) 12-character 2-line in 8-bit operation (Using internal reset circuits).

In the 2-line display, the cursor moves automatically from the 1st to the 2nd line after the 12th character of the first line has been written. Therefore, if the display character is only 8 characters in the 1st line, the DD RAM address must be set by the user programming to change the cursor position to the 2nd line.

The 1st and 2nd line displays will shift at the same time.

When the displayed data is shifted repeatedly, each line moves only horizontally. The 2nd line display does not shift into the 1st line position.

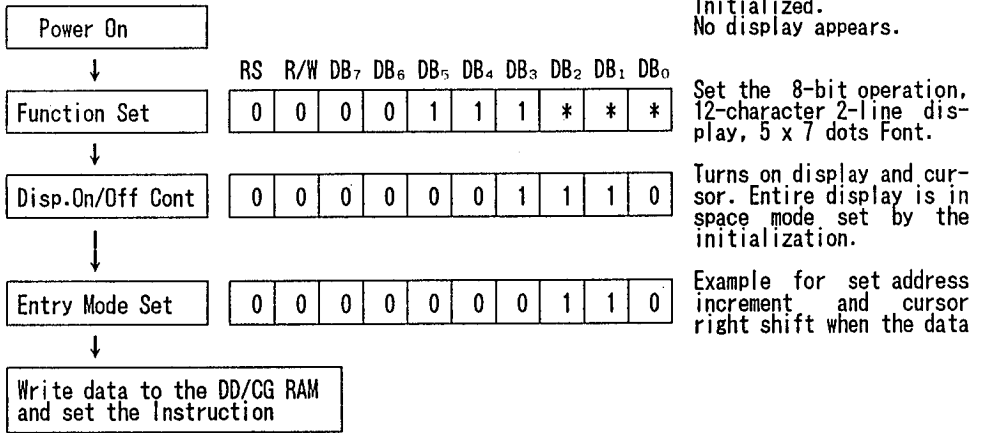

(3-3) Initialization by instruction

If the power supply conditions for the correct operation of the internal reset circuits are not met, the NJU6428/29 must be initialized by the instruction.

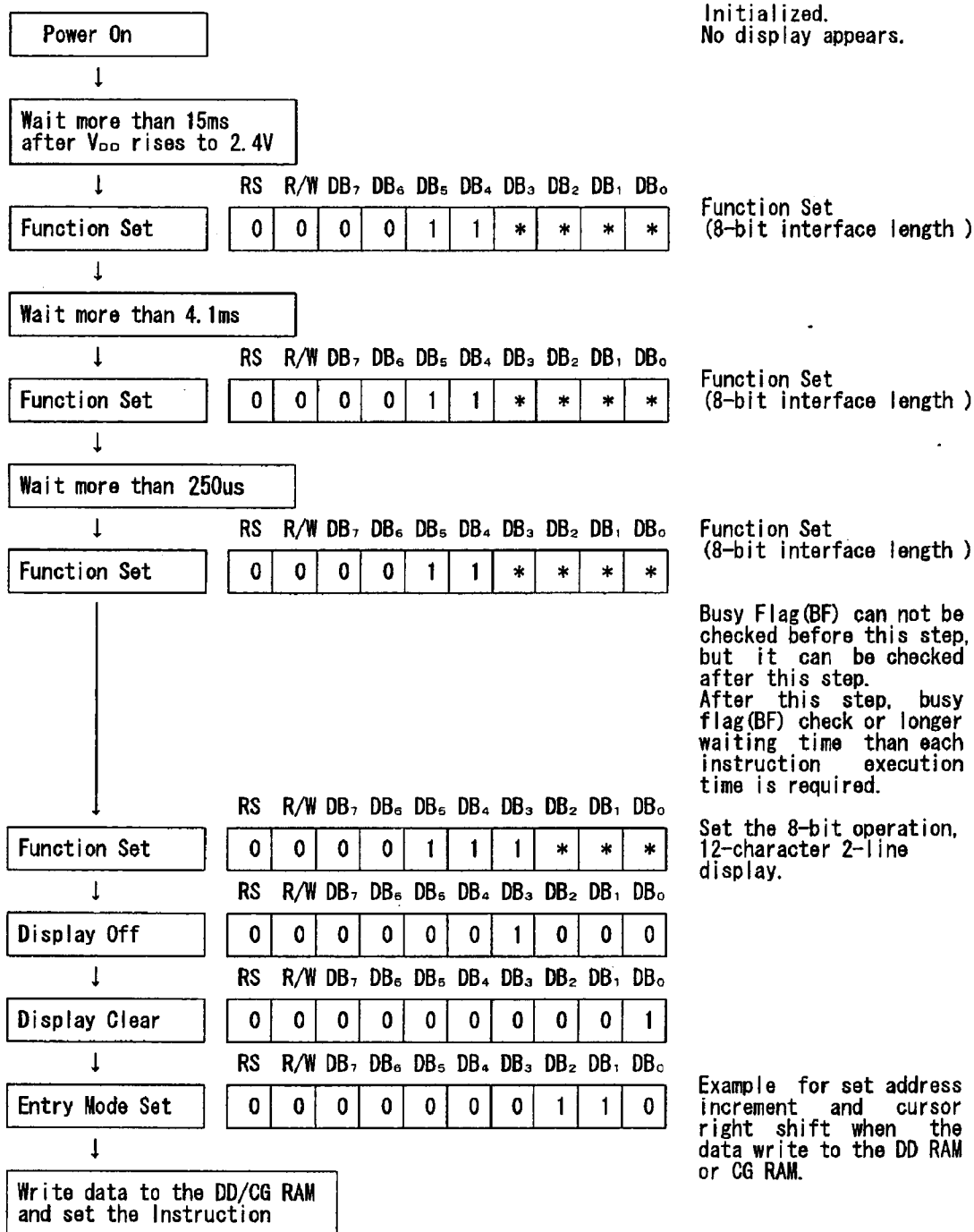
(a) Initialization by Instruction in 8-bit interface length.

(b) Initialization by Instruction in 4-bit interface length

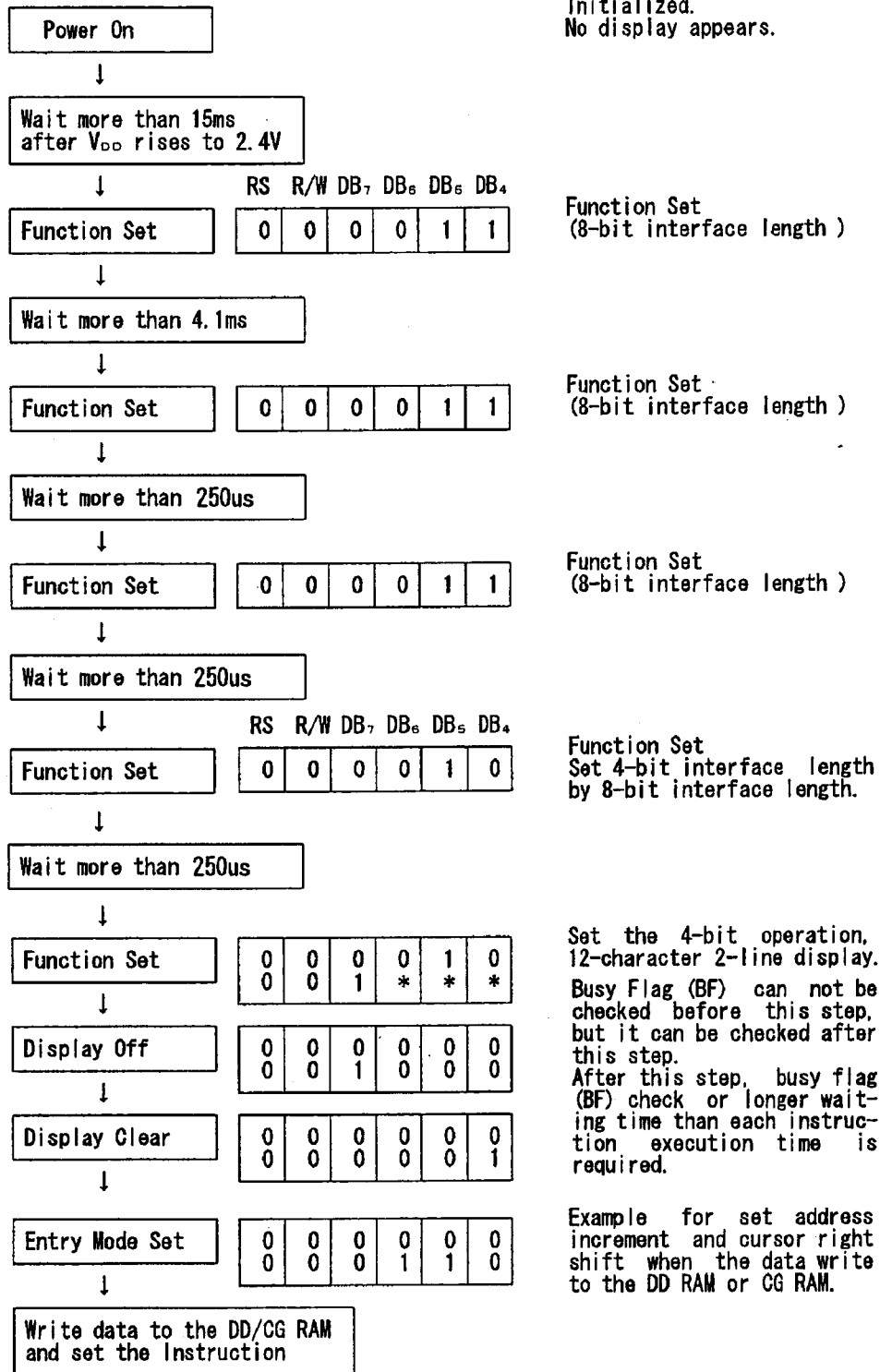

(4) LCD DISPLAY

(4-1) Power Supply for LCD Driving

NJU6428/29 incorporate voltage tripler to generate LCD driving high voltage and bleeder resistance. The voltage tripler generate about triple voltage from the V_{ci} input voltage (7.8V typ at $I_{out}=1mA$ and $V_{ci}=3V$) and bleeder resistance generate each LCD driving voltage. The bleeder resistance is set 1/5 bias suitable for 1/18 duty ratio and 1M Ω per resistance.

Furthermore, the bleeder resistance output the LCD Driving bias level through the voltage follower OP-AMP to get a enough display characteristics with low power consumption.

LCD Driving Voltage vs Duty Ratio

Power supply	Duty Ratio	1/18
	Bias	1/5
V_{5OUT}		V_{DD} to V_{LCD}

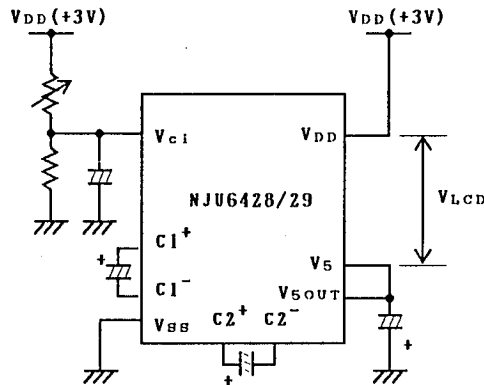

 (a) 1/5 Bias(1/18 Duty)
 (Voltage Tripler used example)

(4-2) Relation between oscillation frequency and LCD frame frequency.

As the NJU6428/29 incorporate oscillation capacitor and resistance for CR oscillation, 80kHz oscillation is available without any external components.

The LCD frame frequency example mentioned below is based on 80kHz oscillation.

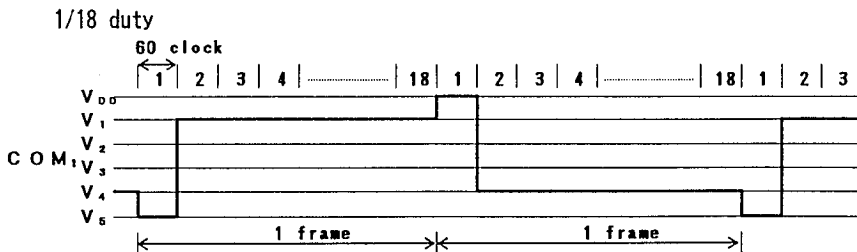
(1 clock = 12.5 μ s)



$$1 \text{ frame} = 12.5(\mu s) \times 60 \times 18 = 13.5(\text{ms})$$

$$\text{Frame frequency} = 1/13.5(\text{ms}) = 74.1(\text{Hz})$$

(5) Interface with MPU

NJU6428/29 can be interfaced with both of 4/8-bit MPU and the two-time 4-bit or one-time 8-bit data transfer is available.

(5-1) 4-bit MPU interface

When the interface length is 4-bit, the data transfer is performed by 4 lines connected to DB₄ to DB₇ (DB₀ to DB₃ are not used). The data transfer with the MPU is completed by the two-time 4-bit data transfer.

The data transfer is executed in the sequence of upper 4-bit (the data DB₄ to DB₇ at 8-bit length) and lower 4-bit (the data DB₀ to DB₃ at 8-bit length).

The busy flag check must be executed after two-time 4bit data transfer (1 instruction execution). In this case the data of busy flag and address counter are also output twice.

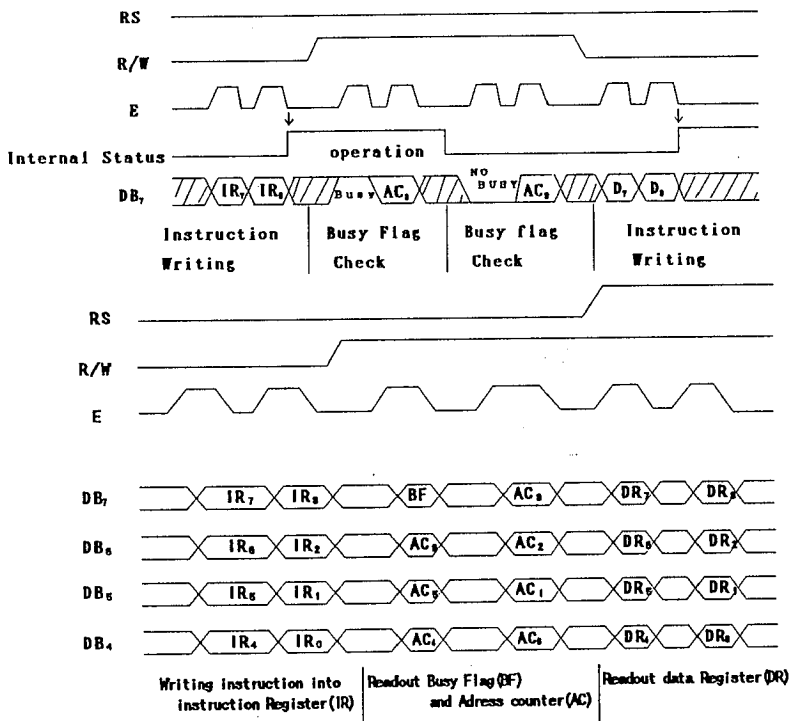

(5-2) 8-bit MPU interface

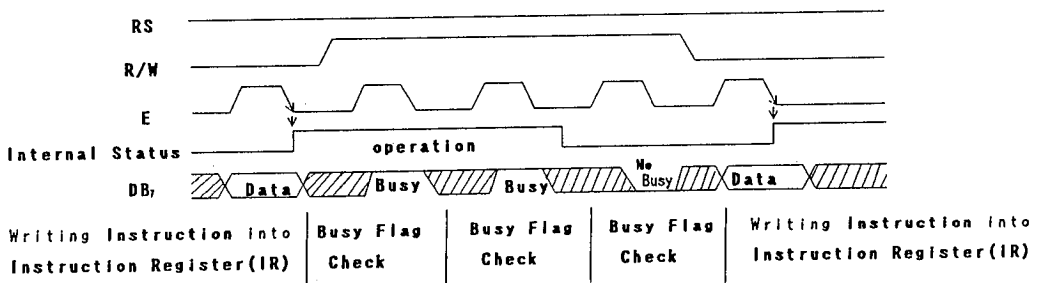

ABSOLUTE MAXIMUM RATINGS

(Ta=25°C)

PARAMETER	SYMBOL	RATINGS	UNIT
Supply Voltage (1)	V _{DD}	- 0.3 ~ + 7.0	V
Input Voltage	V _r	- 0.3 ~ V _{DD} +0.3	V
Operating Temperature	T _{opr}	- 30 ~ + 80	°C
Storage Temperature	T _{stg}	- 55 ~ + 125	°C

Note 1) If the LSI are used on condition above the absolute maximum ratings, the LSI may be destroyed. Using the LSI within electrical characteristics is strongly recommended for normal operation. Use beyond the electric characteristics conditions will cause malfunction and poor reliability.

Note 2) All voltage values are specified as V_{SS} = 0V

Note 3) The relation : V_{DD} ≥ V_{ci} > V_s ≥ V_{sOUT}, V_{SS}=0V must be maintained.

Turn on V_{DD} and V_{ci} at same time or turn on V_{DD} first then turn on V_{ci} must be required. If the turn on sequence does not meet above conditions, latch up will occur.

Note 4) Decoupling Capacitor(C_D) should be connected between V_{ci} and V_{SS} due to stabilized operation for the tripler.

ELECTRICAL CHARACTERISTICS

 (V_{DD}=3V±20%, Ta=-20 ~ +75°C)

PARAMETER	SYMBOL	CONDITIONS	MIN	TYP	MAX	UNIT	NOTE
Operating Voltage	V _{DD}		2.4	3.0	3.6	V	
Input Voltage	V _{IH}		0.8V _{DD}		V _{DD}	V	5
	V _{IL}				0.2V _{DD}	V	
Output Voltage	V _{OH}	-I _{OH} =0.205mA	2.0			V	6
	V _{OL}	I _{OL} =1.6mA			0.5	V	
Driver On-resist.(COM)	R _{COM}	±I _d =5uA(All com.term.)			20	kΩ	9
Driver On-resist.(SEG)	R _{SEG}	±I _d =5uA(All seg.term.)			30	kΩ	
Input Leakage Current	I _{LI}	V _{IN} =0 ~ V _{DD}	- 1		1	uA	7
Pull-up Resist Current	-I _P	V _{DD} =3V, RS, R/W, RESET, DB Terminals	10	25	50	uA	
Operating Current	I _{DD}	V _{DD} =3V, f _{OSC} =Internal freq		100	200	uA	8
Voltage Tripler	Output Volt.	V _{UP} V _{ci} =3V, I _{OUT} =1mA, Ta=25°C	- 4.6	- 4.8		V	
	Input Volt.	V _{ci}	*		V _{DD}	V	
	Conv. Effici	V _{ef} R _L =∞	95.0	99.9		%	
Bleeder resistance	R _B	V _{DD} -V _S =3V, (Per Resistance)		1		MΩ	
Oscillation Frequency	f _{OSC}	V _{DD} =3V, Ta=25°C	56	80	104	kHz	
LCD Driving Voltage	V _{LCD}	V _{sOUT} Terminal, V _{DD} =3V	V _{SS}		V _{DD} -13.5	V	10

* Min value is checking.

Note 5) Input/Output structure except LCD driver are shown below:

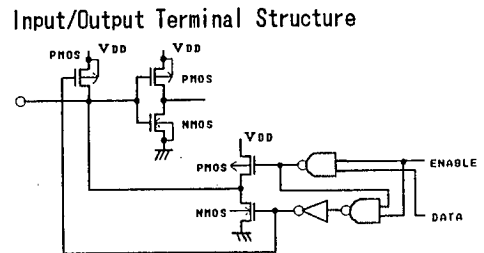
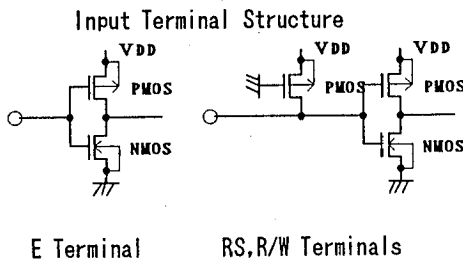

Note 6) Apply to the Output and Input/Output Terminal.

Note 7) Except pull-up resistance current and output driver current.

Note 8) Except Input/output current but including the current flow on bleeder resistance.

If the input level is medium, current consumption will increase due to the penetration current. Therefore, the input level must be fixed to "H" or "L".

Operating Current Measurement Circuit

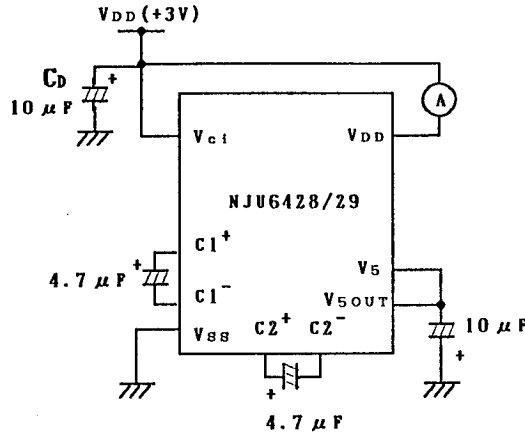

Note 9) R_{COM} and R_{SEG} are the resistance values between power supply terminals (V_{DD} , V_{SOUT}) and each common terminal (COM_1 to COM_{16} / $COMMK$), and supply voltage (V_{DD} , V_{SOUT}) and each segment terminal (SEG_1 to SEG_{60}) respectively, and measured when the current I_d is flown on every common and segment terminals at a same time.

Note 10) Apply to the output voltage from each COM and SEG are less than $\pm 0.15V$ against the LCD driving constant voltage (V_{DD} , V_{SOUT}) at no load condition.

Voltage Tripler Measurement Circuit

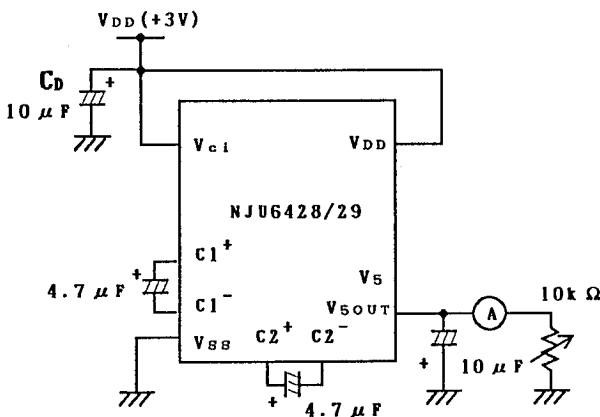

Internal Bleeder Resistance and Voltage Follower

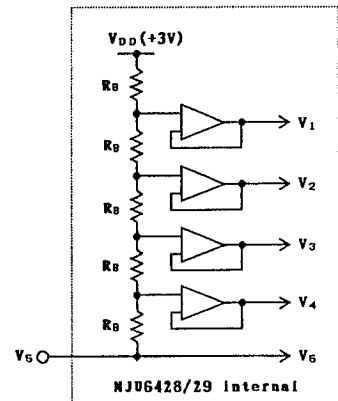

* Voltage Tripler Internal
Clock Frequency = 10kHz

- Bus timing characteristics ($V_{DD} = 3.0V \pm 20\%$, $V_{SS} = 0V$, $T_a = -20 \sim +75^\circ C$)

Write operation (Write from MPU to NJU6428/29)

PARAMETER	SYMBOL	MIN	MAX	CONDITION	UNIT
Enable Cycle Time	t_{CYCE}	1		fig.1	us
Enable Pulse Width "High" level	P_{WEH}	400			ns
Enable Rise Time, Fall Time	t_{Er} , t_{Ef}		20		
Set up Time RS, R/W, E	t_{AS}	40			
Address Hold Time	t_{AH}	10			
Data Set up Time	t_{DSW}	60			
Data Hold Time	t_H	10			

Timing Characteristics (Write operation)

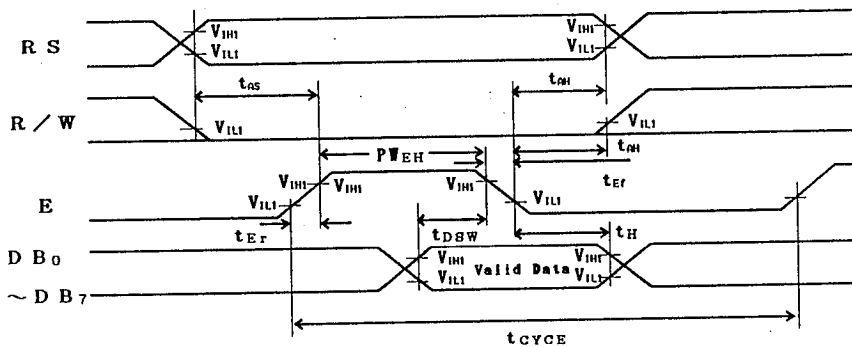

fig. 1

Read operation (Read from NJU6428/29 to MPU)

PARAMETER	SYMBOL	MIN	MAX	CONDITION	UNIT
Enable Cycle Time	t_{CYCE}	1		fig.2	us
Enable Pulse Width "High" level	P_{WEH}	600			ns
Enable Rise Time, Fall Time	t_{Er}, t_{Ef}		20		
Set up Time RS, R/W, E	t_{AS}	40			
Address Hold Time	t_{AH}	10			
Data Delay Time	t_{DDW}		600		
Data Hold Time	t_{DDH}	20			

Timing Characteristics (Read operation)

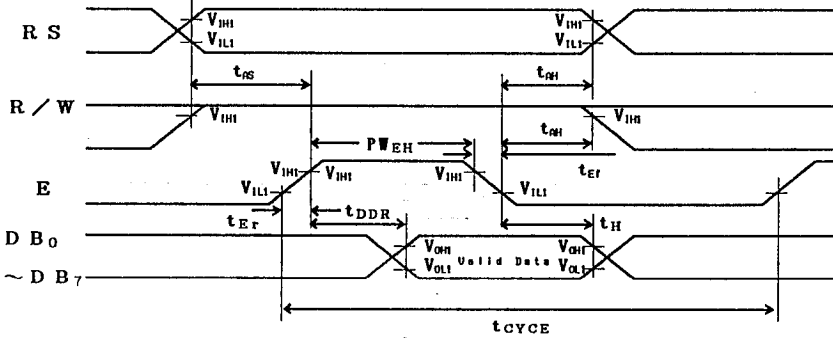
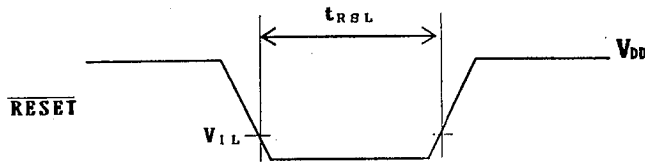

fig. 2

5

• The Input Condition when using the Hardware Reset Circuit

Input Timing



PARAMETER	SYMBOL	CONDITION	MIN	MAX	UNIT
Reset Input "L" Level Width	t_{RSL}	$f_{OSC}=80kHz$	1.2	-	ms

• Power Supply Condition when using the internal initialization circuit ($T_a = -20 \sim +75^\circ C$)

PARAMETER	SYMBOL	CONDITION	MIN	MAX	UNIT
Power Supply Rise Time	t_{RDD}		0.1	5	ms
Power Supply OFF Time	t_{OFF}		1		

Since the internal initialization circuits will not operate normally unless the above conditions are met, in such a case initialize by instruction.
(Refer to initialization by the instruction)

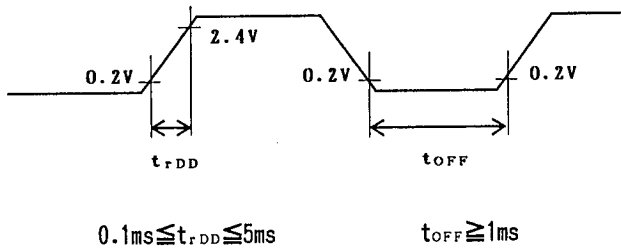

t_{OFF} specifies the power off time in a short period off or cyclical on/off.

LCD DRIVING WAVE FORM

1/18 Duty Driving

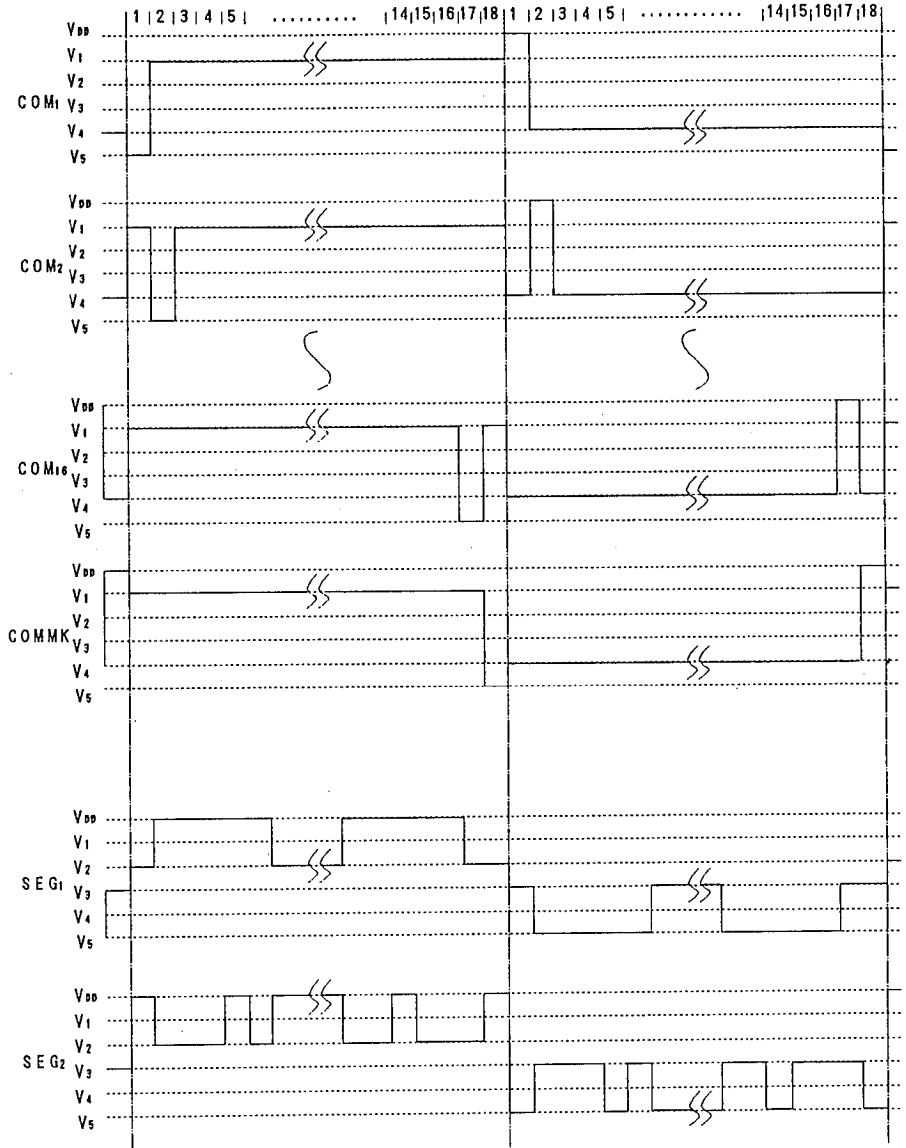
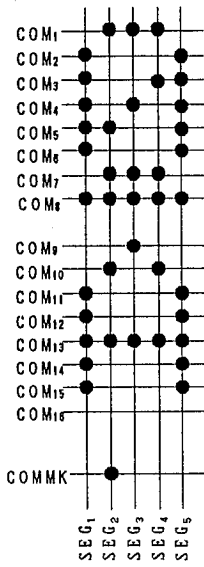

5

■ APPLICATION CIRCUITS (1)

(1) 24-character 1-line WITH iCON Display Example (NJU6428)

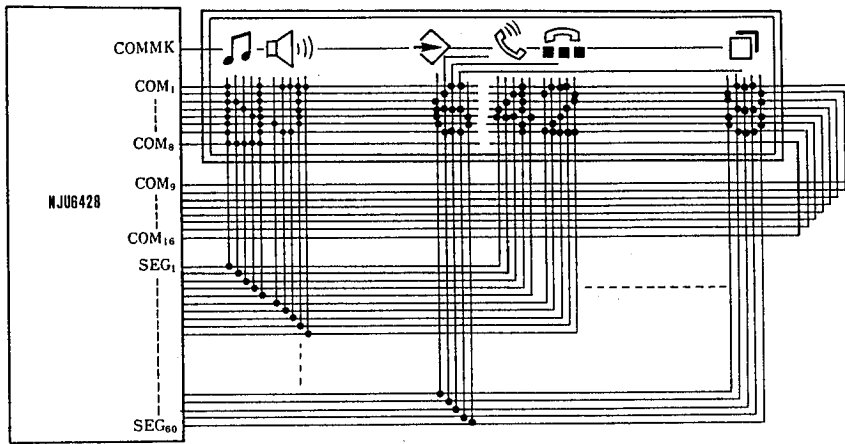

5

(2) 24-character 1-line WITH iCON Display Example (NJU6429)

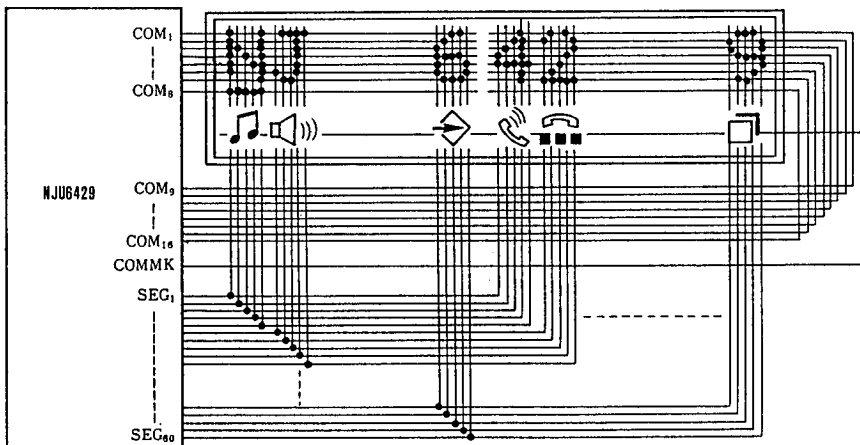

■ APPLICATION CIRCUITS (2)

(1) 12-character 2-line with Icon Display Example (NJU6428)

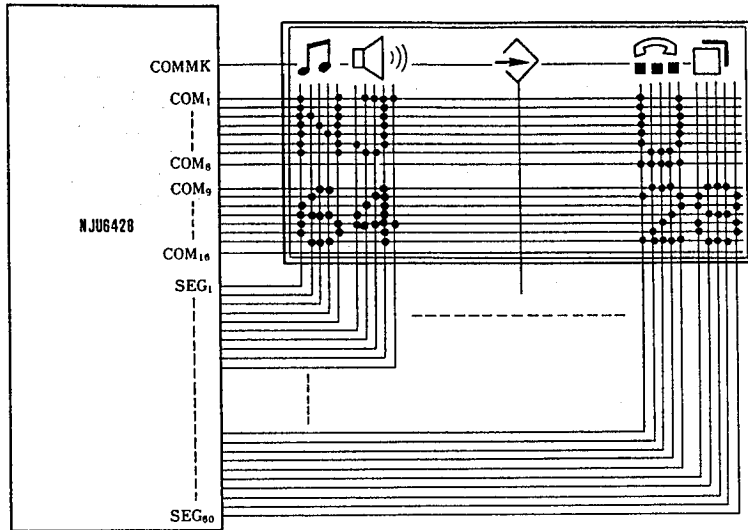

5

(2) 12-character 2-line with Icon Display Example (NJU6429)

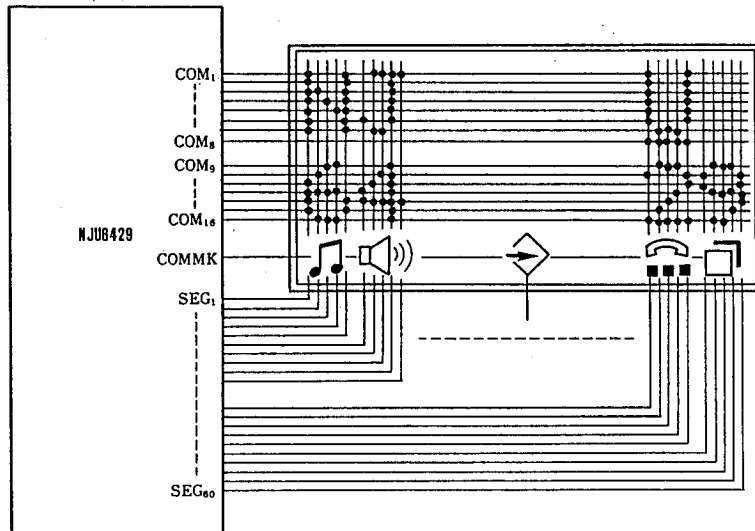

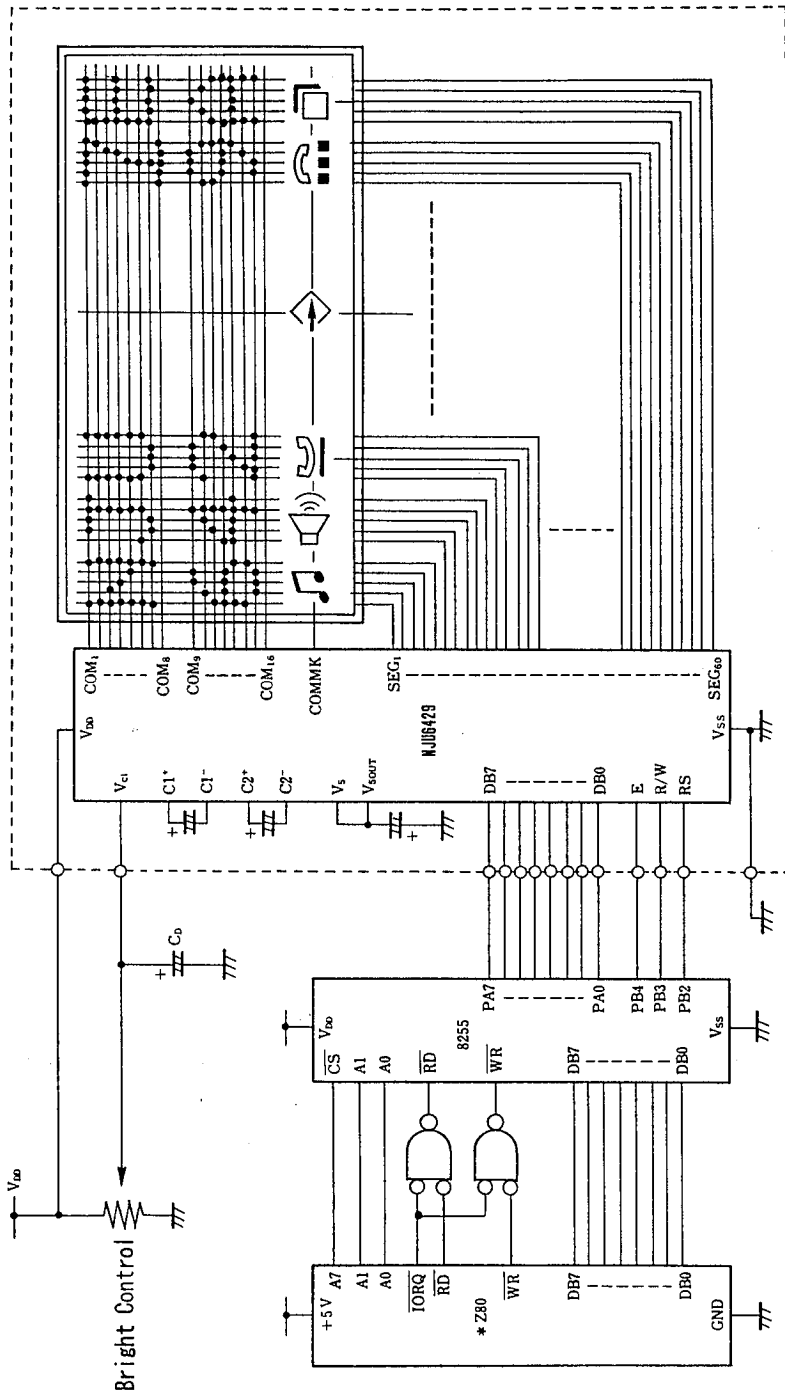

Z80[®] is trade mark of Zilog Inc.

(2) 8 bit MPU interface example (LCD driving voltage is generated by NJU6429)

MEMO

[CAUTION]

The specifications on this databook are only given for information, without any guarantee as regards either mistakes or omissions. The application circuits in this databook are described only to show representative usages of the product and not intended for the guarantee or permission of any right including the industrial rights.