

## PHS MULTI-FUNCTION GaAs MMIC

### ■GENERAL DESCRIPTION

NJG1701V is a GaAs multi-function MMIC composed of a power amplifier, a SPDT switch and a LNA for Japanese PHS or WLL application. The SSOP20 package is adopted, and this package helps downsizing of handsets.

NJG1701V is operated at low voltage, and includes a low current and low distortion PA, a low insertion loss antenna switch and a low noise and high gain LNA.

### ■PACKAGE OUTLINE

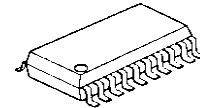

NJG1701V

### ■APPLICATION

- PHS, Digital cordless phone

### ■FEATURES

(Operating frequency  $f=1.9\text{GHz}$ )

Transmitting Mode Operation

- Drain Voltage (PA) 3.0V typ.
- Gain 32dB typ.
- Current Consumption 160mA typ. @ $P_{OUT}=20\text{dBm}$
- Gain Variable Range 33dB typ.

Receiving Mode Operation

- Drain Voltage (LNA) 3.0 typ.
- Gain 13dB typ.
- Current Consumption 2.8mA typ.
- NF 2.7dB typ.
- Control Voltage (SW) 2.7V typ.
- Package SSOP20 (Mount Size: 6.4x6.5x1.25mm)

### ■PIN CONFIGURATION

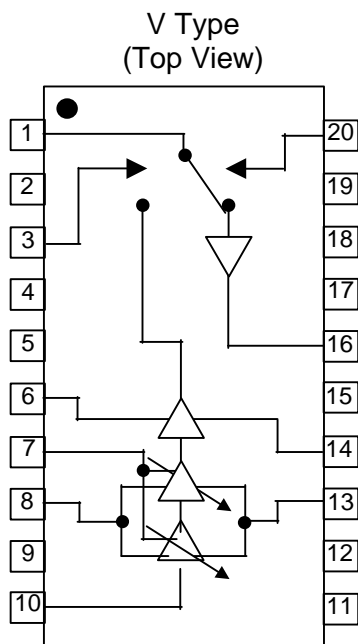

#### Pin Connection

1.ANT	11.GND
2.GND	12.GND
3.V <sub>SW2</sub>	13.V <sub>DD3</sub>
4.GND	14.V <sub>DD2</sub>
5.V <sub>DD1</sub>	15.GND
6.V <sub>GG1</sub>	16.LNAOUT
7.V <sub>CONT</sub>	17.GND
8.V <sub>GG2</sub>	18.EXTIND
9.GND	19.GND
10.PA <sub>IN</sub>	20.V <sub>SW1</sub>

# NJG1701V

## ■ABSOLUTE MAXIMUM RATINGS

( $Z_s=Z_l=50\Omega$ ,  $T_a=25^\circ\text{C}$ )

PARAMETER	SYMBOL	CONDITIONS	RATINGS	UNITS
Drain Voltage1	$V_{DD1}$		6.0	V
Drain Voltage2	$V_{DD2,3}$	$V_{GG1,2}=-0.9\text{V}$	6.0	V
Gate Voltage	$V_{GG1,2}$	$V_{DD2,3}=3.0\text{V}$	-4.0	V
Gain Control Voltage	$V_{cont}$	$V_{DD2,3}=3.0\text{V}$	-4.0	V
Control Voltage	$V_{SW1,2}$		6.0	V
Input Power1	ANT	$V_{DD1}=3.0\text{V}$ , $V_{SW1}=0\text{V}$ , $V_{SW2}=2.7\text{V}$	0	dBm
Input Power2	$PA_{in}$	$V_{DD2,3}=3.0\text{V}$ , $V_{GG1,2}=-0.9\text{V}$	3	dBm
Power Dissipation	$P_D$	With PCB board	800	mW
Operating Temp.	$T_{opr}$		-30~+85	$^\circ\text{C}$
Storage Temp.	$T_{stg}$		-40~+150	$^\circ\text{C}$

## ■ELECTRICAL CHARACTERISTICS 1 (TRANSMITTING MODE: $PA_{in}$ -ANT)

( $f=1.90\text{GHz}$ ,  $V_{SW1}=2.7\text{V}$ ,  $V_{SW2}=0\text{V}$ ,  $V_{CONT}=0\text{V}$ ,  $Z_s=Z_l=50\Omega$ ,  $V_{DD1}=0\text{V}$ ,  $T_a=25^\circ\text{C}$ )

PARAMETER	SYMBOL	CONDITIONS	MIN	TYP	MAX	UNITS
Operating frequency	freq	$V_{DD2,3}=3.0\text{V}$	1.89	1.90	1.92	GHz
Drain voltage	$V_{DD2,3}$	$V_{DD2,3}=3.0\text{V}$ , $I_{idle}=150\text{mA}$	2.9	3.0	5.2	V
Gate voltage	$V_{GG1,2}$	$V_{DD2,3}=3.0\text{V}$ , No RF Signal	-1.3	-0.9	-0.5	V
Idle current *1	$I_{idle}$	$V_{DD2,3}=3.0\text{V}$	145	150	155	mA
Operating current *1	$I_{DD2,3}$	$P_{out}=20\text{dBm}$ , $V_{DD2,3}=3.0\text{V}$	145	160	175	mA
Gate current *2	$I_{GG}$	$P_{out}=20\text{dBm}$ , $V_{DD2,3}=3.0\text{V}$	-50.0	-10.0	0.0	$\mu\text{A}$
Gain control terminal current	$I_{CONT}$	$-2.0 < V_{CONT} < 0.0\text{V}$	-5.0	-2.0	0.0	$\mu\text{A}$
Gain control voltage	$V_{CONT}$	$P_{out}=20\text{dBm}$ , $V_{DD2,3}=3.0\text{V}$	-2.0	0.0	0.0	V
Control voltage 1	$V_{SW1}$	$P_{out}=20\text{dBm}$ , $V_{DD2,3}=3.0\text{V}$	2.5	2.7	5.2	V
Control voltage 2	$V_{SW2}$	$P_{out}=20\text{dBm}$ , $V_{DD2,3}=3.0\text{V}$	-0.2	0.0	0.2	V
Control current	$I_{SW1}$	$V_{DD2,3}=3.0\text{V}$ , $I_{idle}=150\text{mA}$	-	4.0	12.0	$\mu\text{A}$
Small signal gain	Gain1	$V_{DD2,3}=3.0\text{V}$ , $I_{idle}=150\text{mA}$	29	32	35	dB
Gain flatness	$G_{flat1}$	$V_{DD2,3}=3.0\text{V}$ , $I_{idle}=150\text{mA}$	-	0.5	1.0	dB
Gain control range	$G_{CONT}$	$-2.0\text{V} < V_{CONT} < 0.0\text{V}$	29	33	37	dB
$P_{out}$ at 1dB gain compression point	$P_{-1dB}$	$V_{DD2,3}=3.0\text{V}$ , $I_{idle}=150\text{mA}$	20	22	-	dBm
Adjacent Channel Leakage Power 1	$P_{acp1}$	$P_{out}=20\text{dBm}$ , offset=600kHz, $I_{idle}=150\text{mA}$ $P_{in}=\pi/4$ QPSK, $V_{DD2,3}=3.0\text{V}$	-	-60	-55	dBc
Adjacent Channel Leakage Power 2	$P_{acp2}$	$P_{out}=20\text{dBm}$ , offset=900kHz, $I_{idle}=150\text{mA}$ , $P_{in}=\pi/4$ QPSK, $V_{DD2,3}=3.0\text{V}$	-	-65	-60	dBc

PARAMETER	SYMBOL	CONDITIONS	MIN	TYP	MAX	UNITS
Harmonics	$P_{hm}$	$P_{out}=20dBm, V_{DD2,3}=3.0V$ $I_{idle}=150mA$	-	-40	-30	dBc
PA <sub>in</sub> Port VSWR	VSWR1	$V_{DD2,3}=3.0V, I_{idle}=150mA$	-	1.7	2.2	
ANT-LNAOUT Isolation	$I_{SL}$	$V_{DD1}=0V, V_{SW1}=2.7V,$ $V_{SW2}=0V$	35	40	-	dB
ANT Port Load VSWR Tolerance	-	$P_{out}=20dBm, V_{DD2,3}=3.0V,$ $I_{idle}=150mA$	Parasitic Oscillation for Fundamental Signal Level $\leq -60dBc$			
Switching time	$T_{SW1}$	Load VSWR=4:1, All phase	-	15	-	nS

## ■ ELECTRICAL CHARACTERISTICS 2 (RECEIVING MODE; ANT - LNAOUT)

(f=1.90GHz,  $V_{SW1}=0V, V_{SW2}=2.7V, Z_s=Z_l=50\Omega, V_{DD2,3}=V_{GG1,2}=V_{CONT}=0V, T_a=25^\circ C$ )

PARAMETER	SYMBOL	CONDITIONS	MIN	TYP	MAX	UNITS
Operating frequency	freq	$V_{DD1}=3.0V$	1.89	1.90	1.92	GHz
Drain voltage	$V_{DD1}$		2.7	3.0	5.2	V
Operating current *3	$I_{DD1}$	$V_{DD1}=3.0V$	2	2.8	4.2	mA
Control voltage 1	$V_{SW1}$		-0.2	0.0	0.2	V
Control voltage 2	$V_{SW2}$		2.5	2.7	5.2	
Control current	$I_{SW2}$		-	4.0	12.0	$\mu A$
Small signal gain	Gain2	$V_{DD1}=3.0V$	12	13	16	dB
Gain flatness	$G_{flat2}$	$V_{DD1}=3.0V$	-	0.5	1.0	dB
Noise figure	NF	$V_{DD1}=3.0V$	-	2.7	3.3	dB
ANT Port VSWR	VSWR2	$V_{DD1}=3.0V$	-	1.7	2.2	
LNAOUT Port VSWR	VSWR3	$V_{DD1}=3.0V$	-	2.0	2.5	
Output 3 <sup>rd</sup> order intercept point	OIP3	$V_{DD1}=3.0V$	-10	0	-	dBm
Switching time	$T_{SW2}$		-	15	-	nS

\*1: Total current of  $V_{DD2}$  and  $V_{DD3}$  terminal.

\*2: Total current of  $V_{GG1}$  and  $V_{GG2}$  terminal.

\*3: Current of  $V_{DD1}$  terminal.

# NJG1701V

## ■ TYPICAL CHARACTERISTICS TRANSMITTING MODE

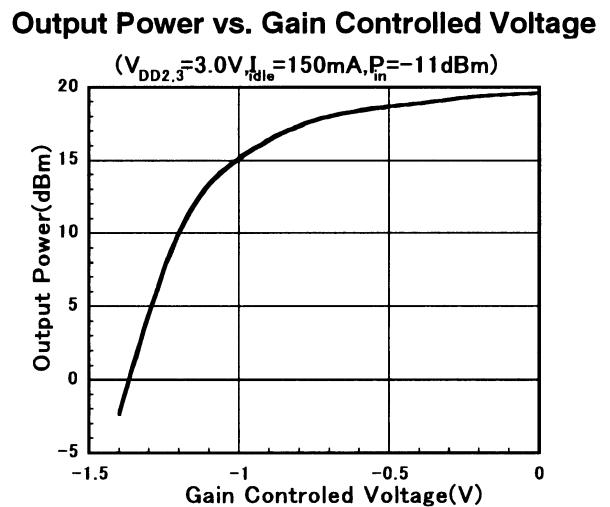
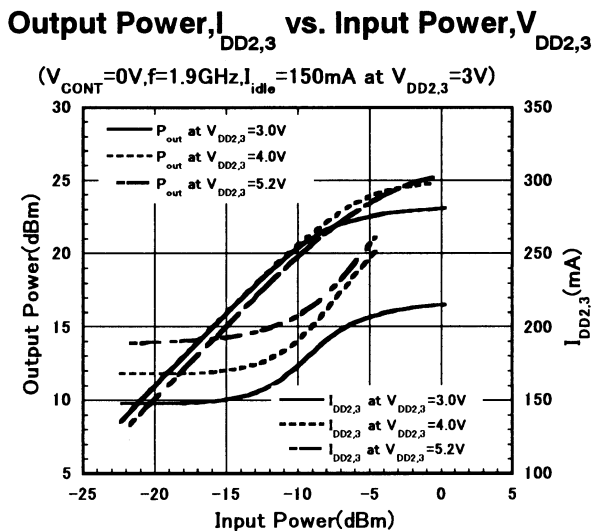
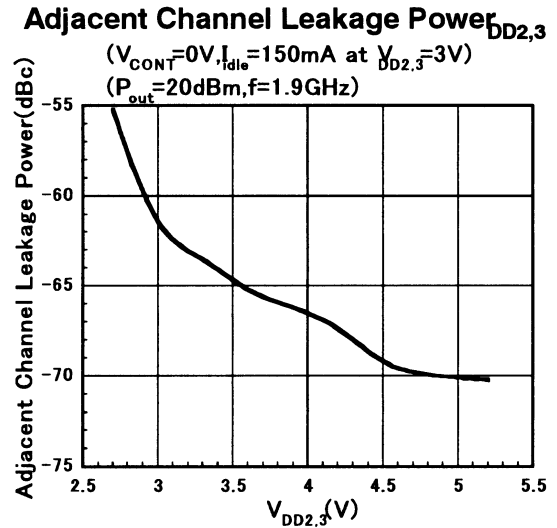
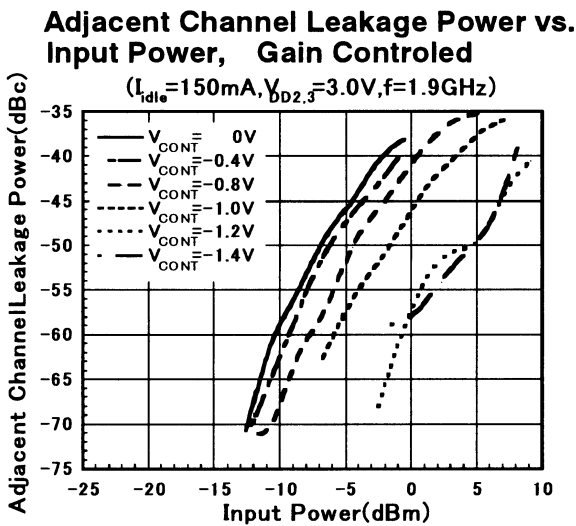
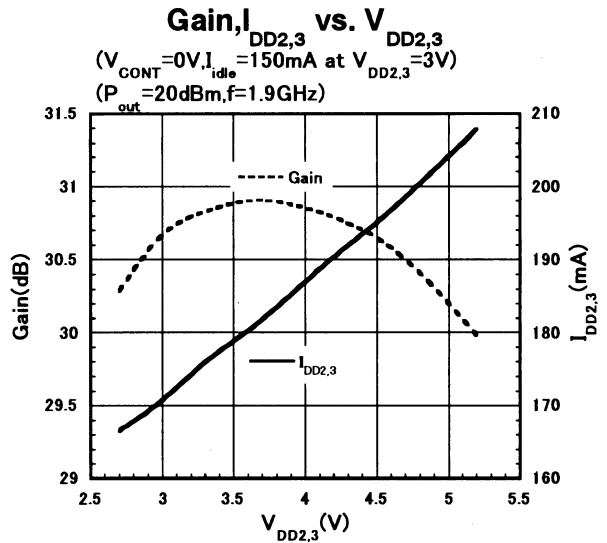
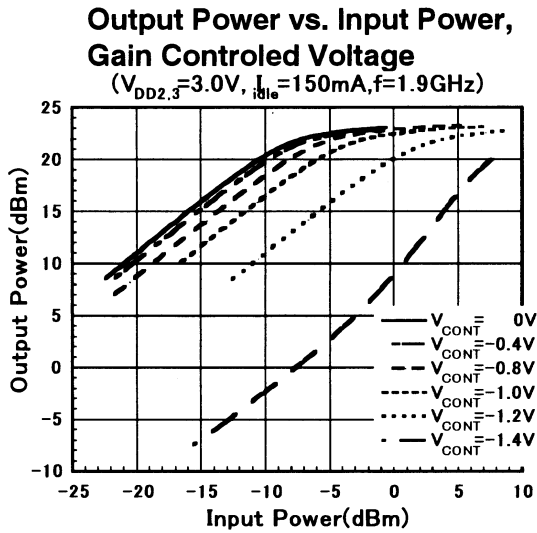

## ■ TYPICAL CHARACTERISTICS TRANSMITTING MODE

### Adjacent Channel Leakage Power Gain Controlled Voltage

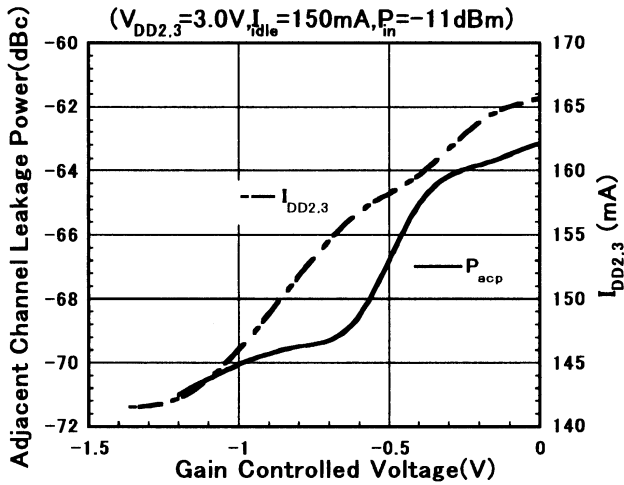

### Output Power vs. Input Power, Temperature

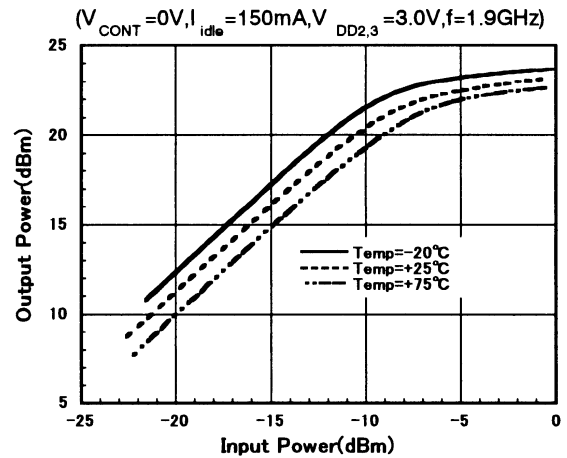

### $I_{DD2,3}$ Gain vs. Temperature

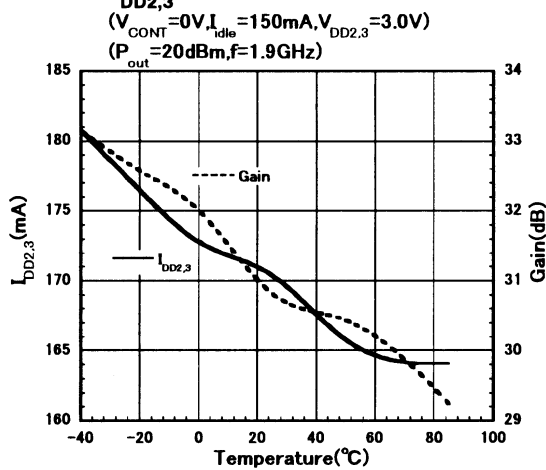

### $I_{DD2,3}$ vs. Input Power, Temperature

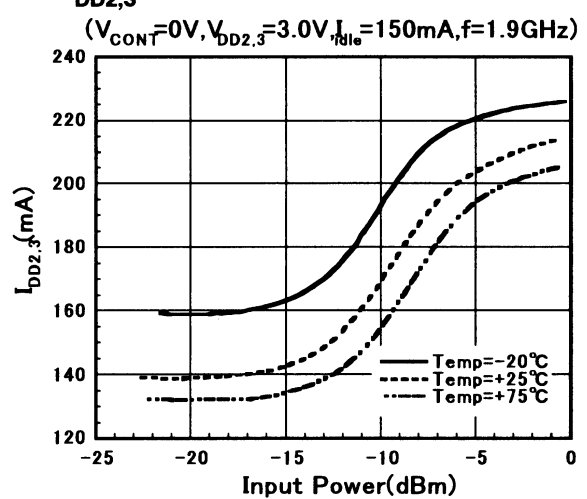

### Adjacent Channel Leakage Power vs. Temperature

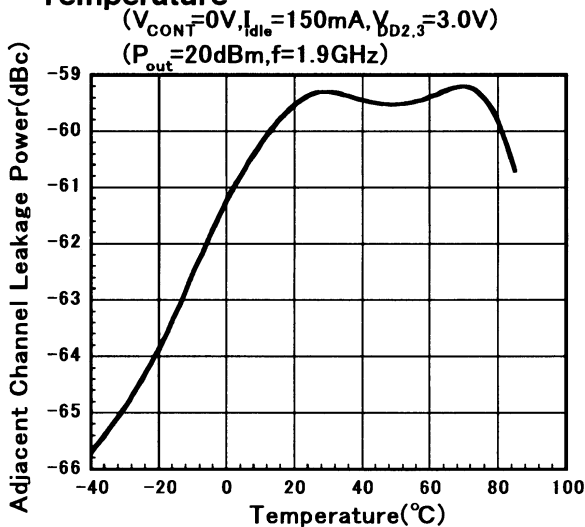

# NJG1701V

## ■ TYPICAL CHARACTERISTICS TRANSMITTING MODE

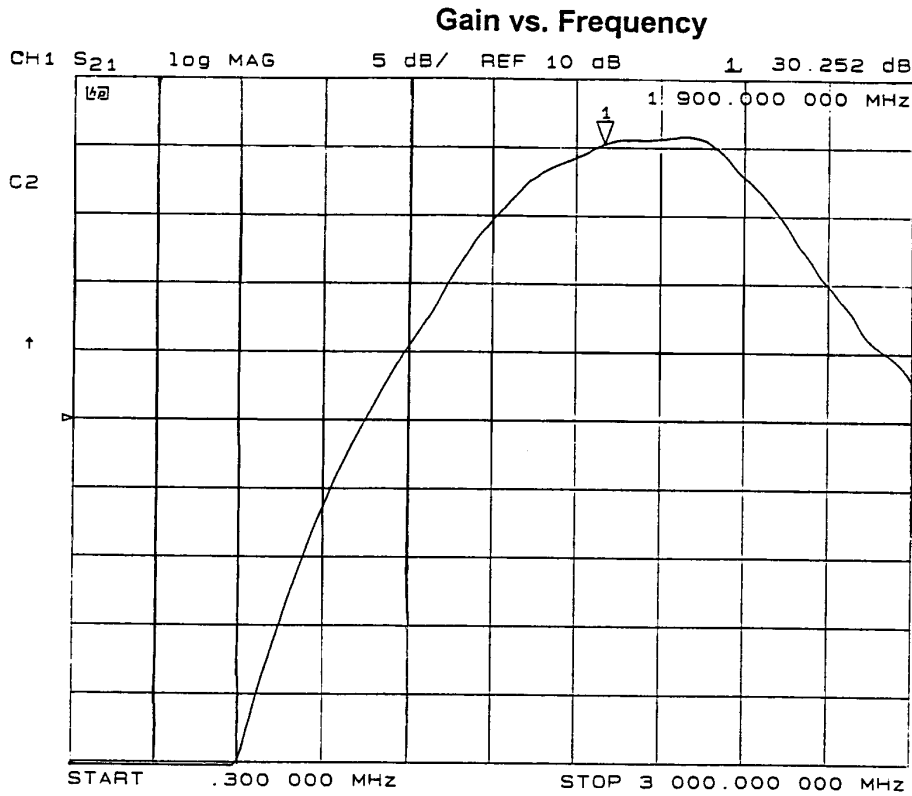

$V_{SW1}=2.7V$   
 $V_{SW2}=0V$   
 $V_{CONT}=0V$   
 $V_{DD1}=0V$   
 $V_{DD2,3}=3.0V$   
 $I_{idle}=150mA$

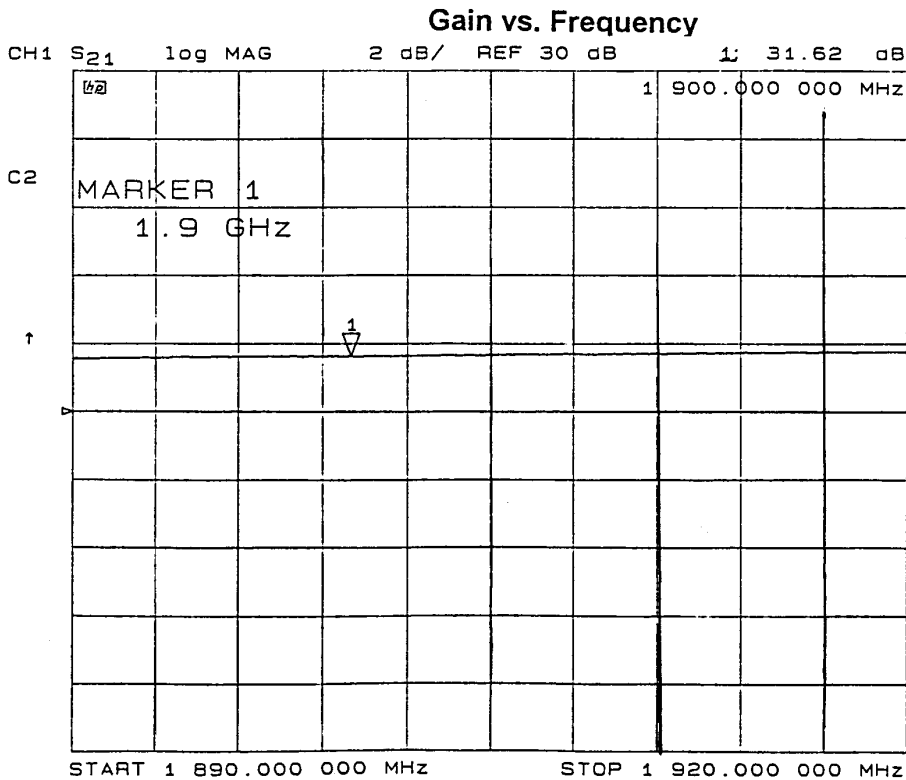

$V_{SW1}=2.7V$   
 $V_{SW2}=0V$   
 $V_{CONT}=0V$   
 $V_{DD1}=0V$   
 $V_{DD2,3}=3.0V$   
 $I_{idle}=150mA$

## ■ TYPICAL CHARACTERISTICS

## TRANSMITTING MODE

### Return loss vs. Frequency

CH1 S<sub>11</sub> log MAG 5 dB/ REF 0 dB 1 -14.106 dB  
 CH2 S<sub>22</sub> log MAG 5 dB/ REF 0 dB 1 -12.684 dB

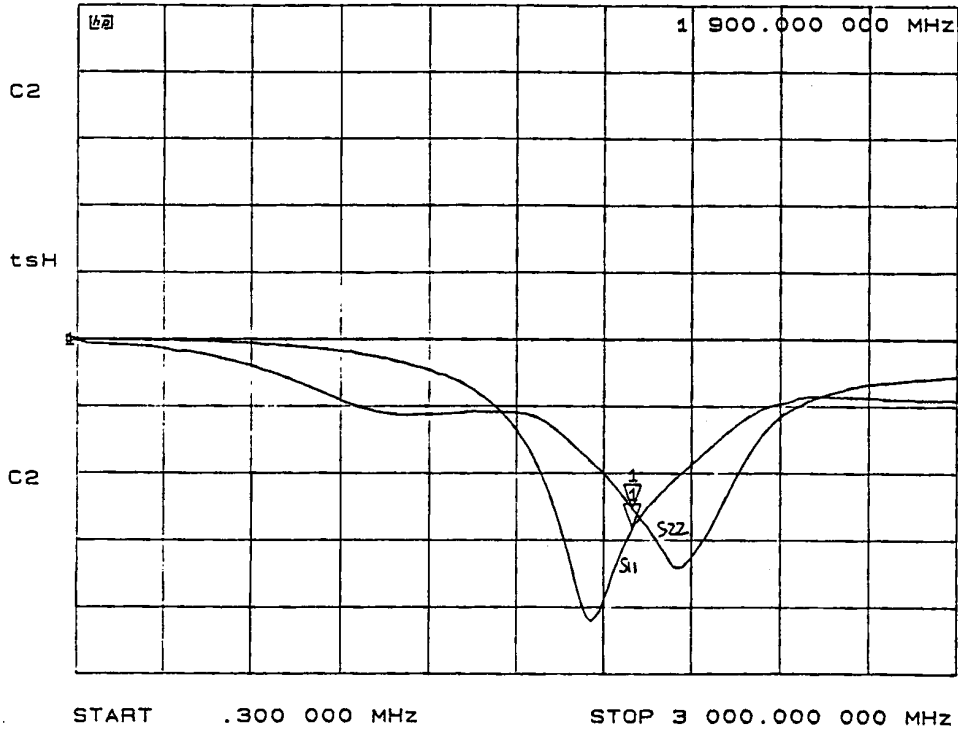

V<sub>SW1</sub>=2.7V  
 V<sub>SW2</sub>=0V  
 V<sub>CONT</sub>=0V  
 V<sub>DD1</sub>=0V  
 V<sub>DD2,3</sub>=3.0V  
 I<sub>idle</sub>=150mA

### Adjacent Channel Leakage Power Spectrum

ATTEN 20dB  
 RL 10.0dBm 10dB/

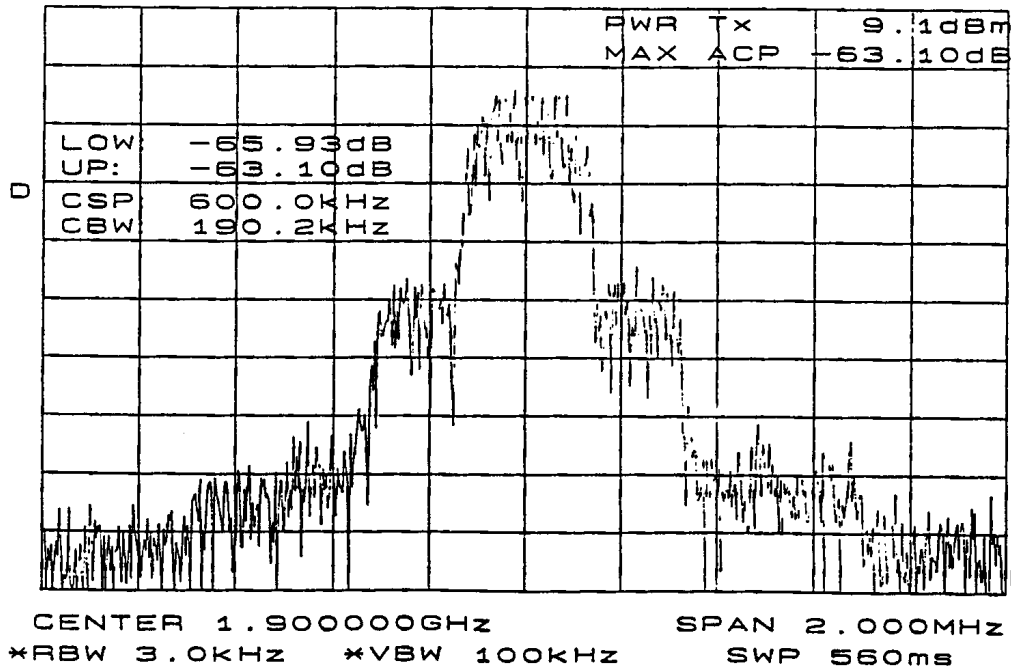

V<sub>SW1</sub>=2.7V  
 V<sub>SW2</sub>=0V  
 V<sub>CONT</sub>=0V  
 V<sub>DD1</sub>=0V  
 V<sub>DD2,3</sub>=3.0V  
 I<sub>idle</sub>=150mA  
 P<sub>out</sub>=20dBm





## ■ TYPICAL CHARACTERISTICS RECEIVING MODE

### Noise Figure vs. Frequency

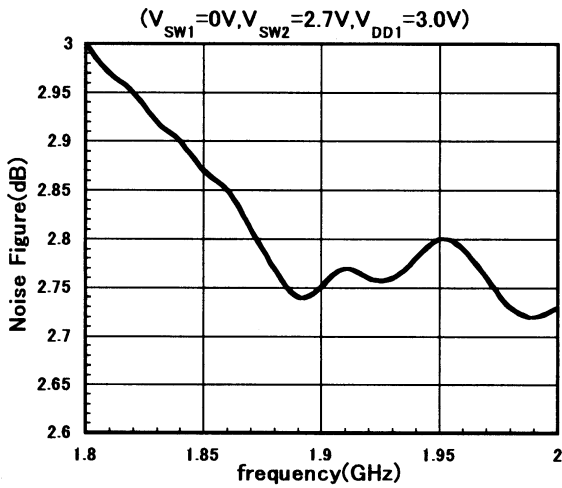

### $I_{DD1}$ , Gain vs Temperature

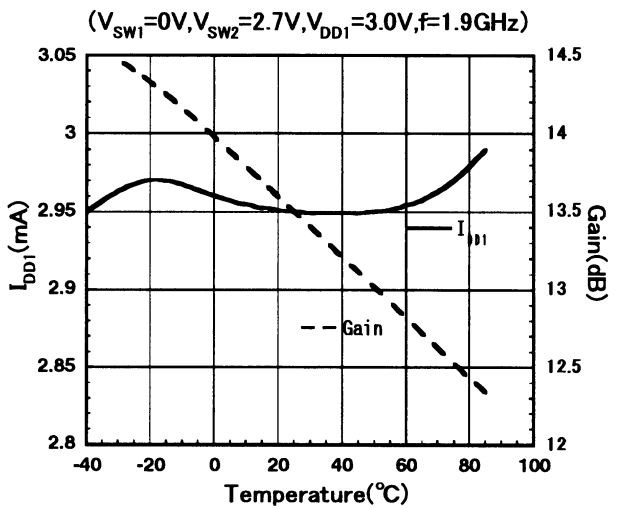

### $I_{DD1}$ , Gain vs Temperature

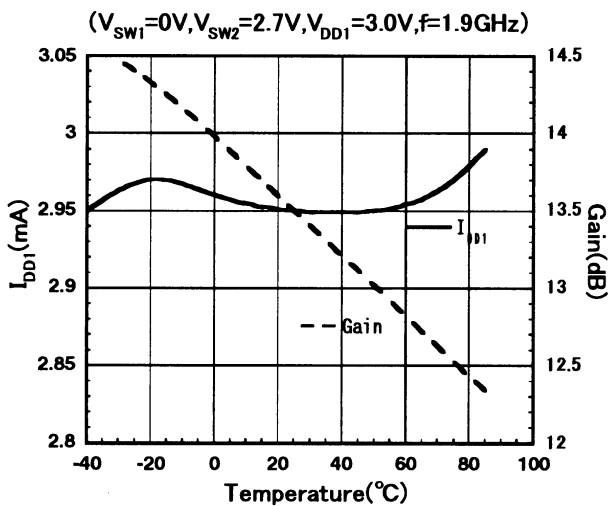

### Noise Figure vs. Temperature

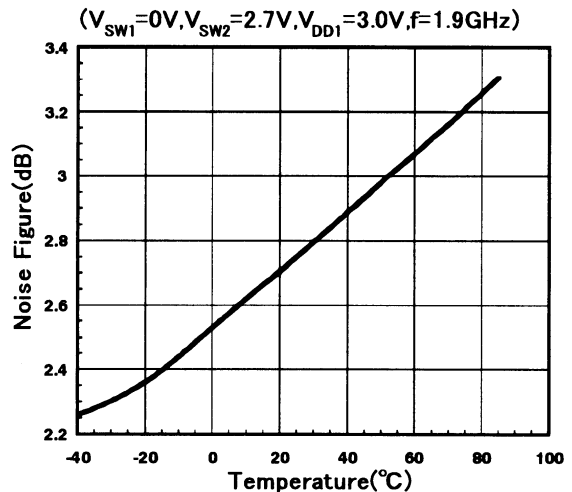

# NJG1701V

## ■ TYPICAL CHARACTERISTICS RECEIVING MODE

### Gain vs. Frequency

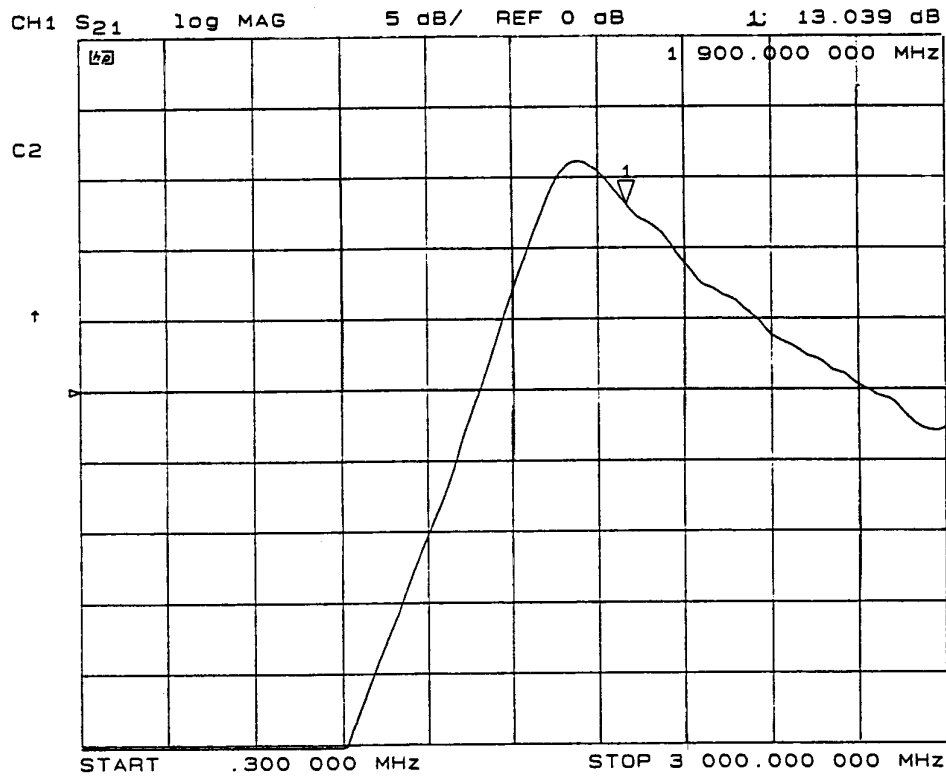

V<sub>SW1</sub>=0V  
V<sub>SW2</sub>=2.7V  
V<sub>DD1</sub>=3.0V  
V<sub>DD2,3</sub>=0V

### Return loss vs. Frequency

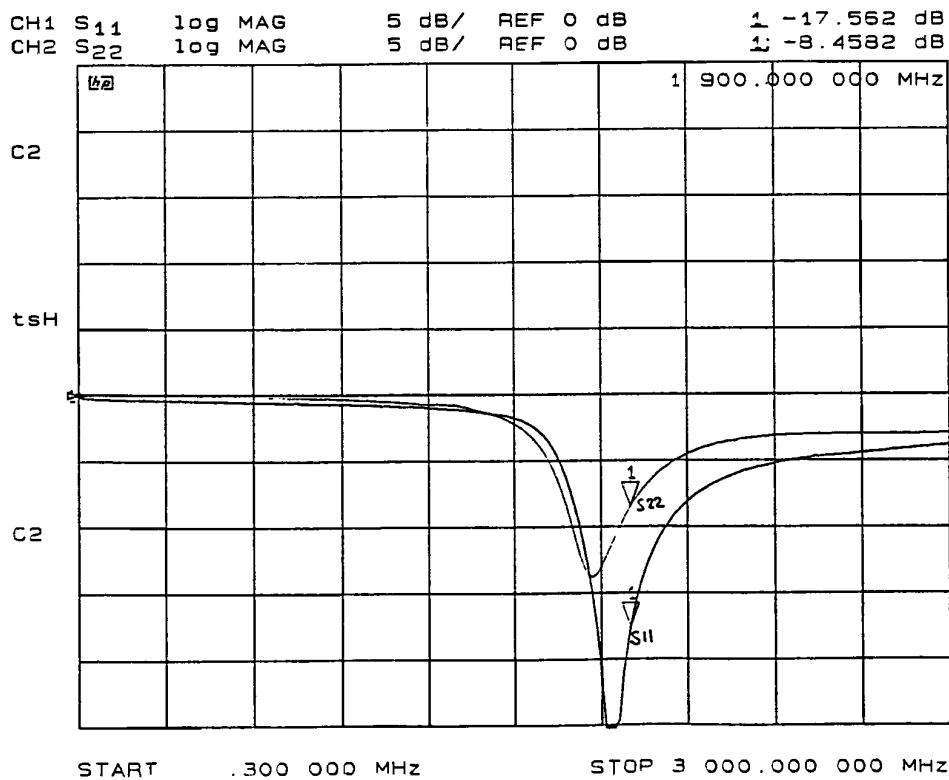

V<sub>SW1</sub>=0V  
V<sub>SW2</sub>=2.7V  
V<sub>DD1</sub>=3.0V  
V<sub>DD2,3</sub>=0V

## ■ TYPICAL CHARACTERISTICS

### TRANSMITTING MODE

Scattering parameters

$V_{SW1}=2.7V$ ,  $V_{SW2}=0V$ ,  $V_{CONT}=0V$ ,  $V_{DD2,3}=3.0V$ ,  $I_{idle}=150mA$

Freq [GHz]	S11		S21		S12		S22	
	mag [U]	ang [deg]	mag [U]	ang [deg]	mag [U]	ang [deg]	mag [U]	ang [deg]
0.10	0.984	-25.5	0.0014	-115.8	0.0002	179.8	0.962	-6.2
0.20	0.981	-49.5	0.0030	-44.1	0.0002	-75.8	0.954	-13.0
0.30	0.976	-75.2	0.0070	-127.1	0.0002	-46.6	0.931	-18.9
0.40	0.965	-99.5	0.0200	-135.3	0.0003	-159.3	0.908	-25.1
0.50	0.960	-124.4	0.0810	-179.6	0.0004	-167.4	0.858	-30.5
0.60	0.939	-148.7	0.2281	140.0	0.0007	175.0	0.806	-37.4
0.70	0.925	-174.3	0.5201	101.0	0.0010	149.8	0.744	-40.7
0.80	0.901	161.5	1.0599	61.5	0.0015	130.7	0.675	-45.7
0.90	0.871	136.2	1.9032	23.2	0.0019	108.2	0.618	-45.1
1.00	0.836	111.1	3.1884	-15.8	0.0023	85.2	0.578	-45.9
1.10	0.789	86.0	4.8575	-52.9	0.0028	66.7	0.569	-43.1
1.20	0.731	59.2	7.1517	-89.4	0.0032	45.7	0.568	-45.6
1.30	0.664	32.8	9.8763	-123.7	0.0034	28.9	0.576	-47.1
1.40	0.575	4.4	15.1324	-159.4	0.0038	12.3	0.579	-51.5
1.50	0.458	-24.2	20.2683	161.7	0.0041	-6.7	0.571	-57.3
1.60	0.291	-54.0	26.9543	119.7	0.0039	-28.2	0.513	-68.0
1.70	0.141	-76.4	31.9275	78.3	0.0034	-43.7	0.425	-73.8
1.80	0.060	6.2	36.4196	37.6	0.0030	-62.4	0.318	-73.5
1.89	0.153	10.7	39.8900	2.2	0.0026	-63.1	0.254	-67.9
1.90	0.165	8.9	40.2071	-1.8	0.0025	-63.9	0.246	-67.1
1.91	0.175	6.7	40.5122	-5.7	0.0024	-68.3	0.238	-66.1
1.92	0.187	4.9	40.9092	-9.8	0.0024	-68.0	0.231	-64.9
2.00	0.263	-4.4	43.9007	-40.9	0.0023	-64.0	0.185	-54.7
2.10	0.339	-26.2	48.4188	-82.2	0.0023	-65.5	0.142	-30.4
2.20	0.465	-44.1	50.0754	-128.9	0.0027	-70.3	0.196	13.3
2.30	0.577	-72.8	44.1354	-178.6	0.0030	-85.2	0.375	20.5
2.40	0.619	-100.2	32.6524	136.9	0.0027	-98.9	0.535	8.3
2.50	0.614	-126.2	22.5856	100.2	0.0026	-107.9	0.610	-2.2
2.60	0.593	-147.4	15.6441	70.2	0.0021	-122.9	0.670	-10.7
2.70	0.577	-166.4	11.2877	44.3	0.0020	-113.7	0.690	-15.9
2.80	0.569	174.5	8.2112	20.5	0.0017	-118.4	0.720	-20.9
2.90	0.548	156.9	6.2537	-1.0	0.0023	-114.8	0.724	-24.0
3.00	0.550	136.9	4.7160	-22.3	0.0019	-146.3	0.744	-29.2

# NJG1701V

## ■ TYPICAL CHARACTERISTICS

### RECEIVING MODE

Scattering parameters

$V_{SW1}=0V$ ,  $V_{SW2}=2.7V$ ,  $V_{DD1}=3.0V$

Freq [GHz]	S11		S21		S12		S22	
	mag [U]	ang [deg]	mag [U]	ang [deg]	mag [U]	ang [deg]	mag [U]	ang [deg]
0.10	0.949	-24.5	0.0007	-22.3	0.0001	-13.8	1.005	0.8
0.20	0.937	-47.2	0.0005	-94.2	0.0000	38.9	1.006	1.2
0.30	0.931	-71.7	0.0007	42.4	0.0003	49.0	1.001	2.6
0.40	0.924	-94.6	0.0012	56.9	0.0002	157.5	1.006	3.3
0.50	0.925	-118.2	0.0032	-12.0	0.0002	118.5	1.001	4.6
0.60	0.909	-141.3	0.0048	4.8	0.0002	42.3	0.994	4.3
0.70	0.903	-165.9	0.0122	-43.4	0.0001	51.9	0.988	6.1
0.80	0.896	171.2	0.0268	-74.1	0.0002	27.7	0.979	6.0
0.90	0.886	146.7	0.0507	-101.9	0.0003	-8.5	0.970	7.4
1.00	0.878	122.6	0.0945	-129.9	0.0008	-27.8	0.961	7.6
1.10	0.867	98.2	0.1660	-155.6	0.0012	-49.7	0.949	9.1
1.20	0.851	72.1	0.3007	177.2	0.0021	-71.0	0.932	8.2
1.30	0.841	45.4	0.5265	149.1	0.0035	-99.1	0.915	7.9
1.40	0.823	16.7	1.0462	119.6	0.0055	-119.6	0.880	4.5
1.50	0.795	-15.1	2.0399	81.6	0.0087	-151.5	0.813	0.3
1.60	0.699	-56.4	4.2567	28.6	0.0098	175.6	0.638	-9.5
1.70	0.442	-106.2	6.4879	-41.7	0.0104	158.5	0.339	-12.7
1.80	0.096	-154.7	6.2827	-111.1	0.0134	151.3	0.210	50.8
1.89	0.100	1.8	5.0324	-159.6	0.0184	133.0	0.363	76.3
1.90	0.119	-3.0	4.8886	-164.3	0.0190	130.5	0.381	77.2
1.91	0.140	-6.0	4.7393	-168.9	0.0198	128.9	0.399	78.0
1.92	0.160	-8.3	4.6134	-173.7	0.0200	126.9	0.415	78.6
2.00	0.272	-29.6	3.6972	154.5	0.0239	107.3	0.523	80.8
2.10	0.383	-62.5	2.8789	120.2	0.0275	83.8	0.614	81.7
2.20	0.460	-87.8	2.2786	90.7	0.0301	63.0	0.675	81.0
2.30	0.508	-113.9	1.8558	64.5	0.0322	43.6	0.712	83.0
2.40	0.532	-138.1	1.5508	40.2	0.0345	26.4	0.726	84.1
2.50	0.555	-162.4	1.3178	18.0	0.0365	9.2	0.736	88.3
2.60	0.566	174.6	1.1358	-4.1	0.0379	-7.0	0.733	90.1
2.70	0.575	152.2	0.9882	-24.6	0.0397	-22.0	0.744	95.7
2.80	0.587	129.6	0.8661	-45.3	0.0413	-38.1	0.737	99.0
2.90	0.584	106.3	0.7524	-64.4	0.0423	-53.3	0.756	105.4
3.00	0.609	84.3	0.6545	-83.0	0.0433	-67.8	0.754	110.5

## ■BLOCK DIAGRAM

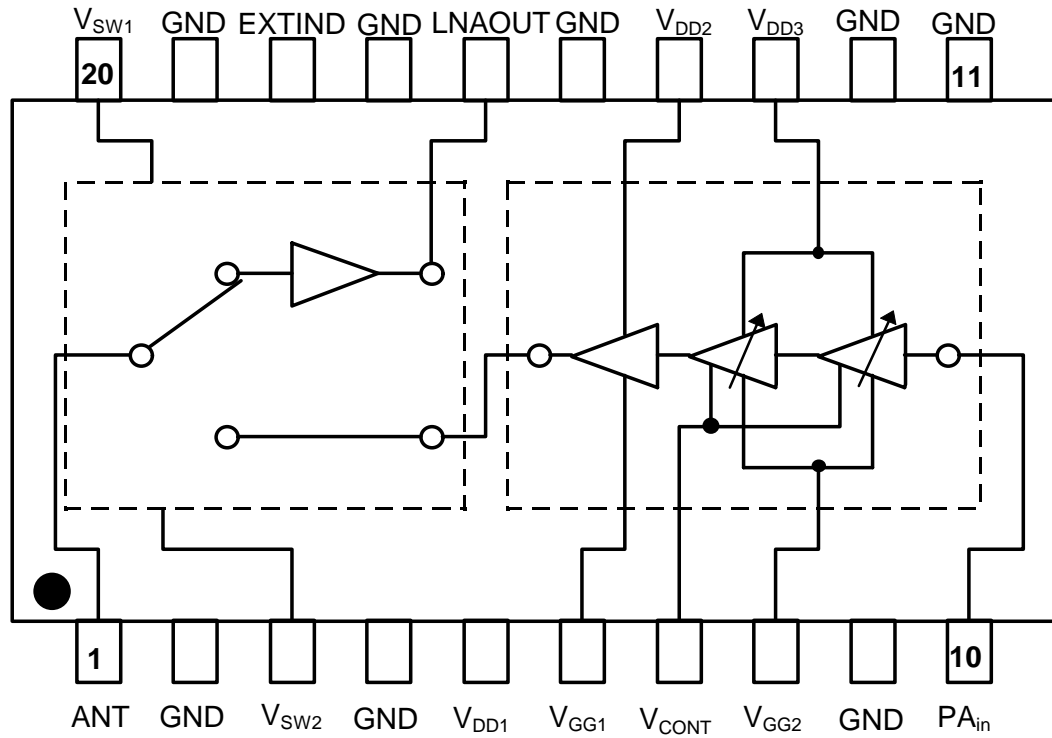

# NJG1701V

## APPLICATION CIRCUIT

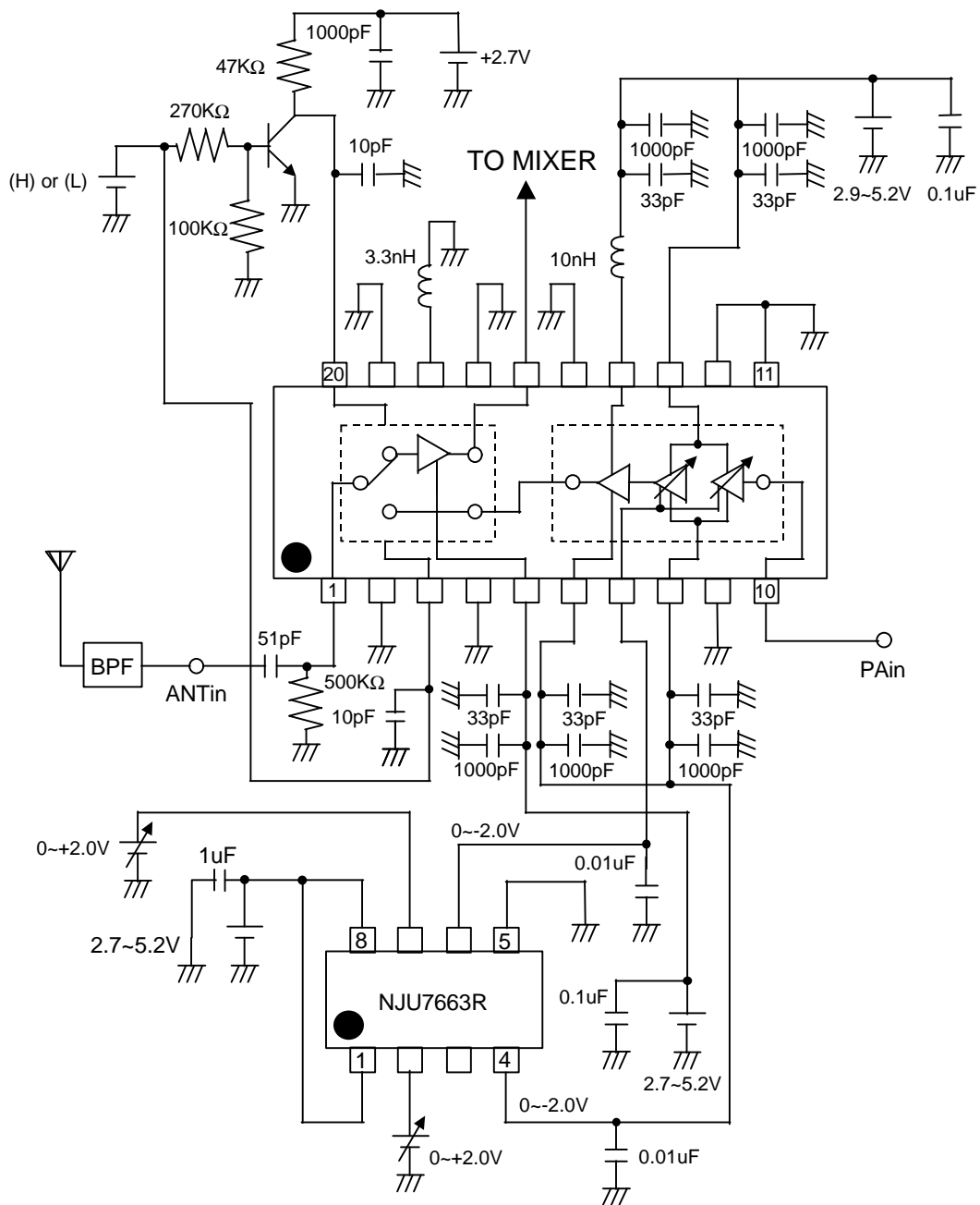

The reflow method is recommended to mount this device on PCB board.

## RECOMMENDED PCB DESIGN

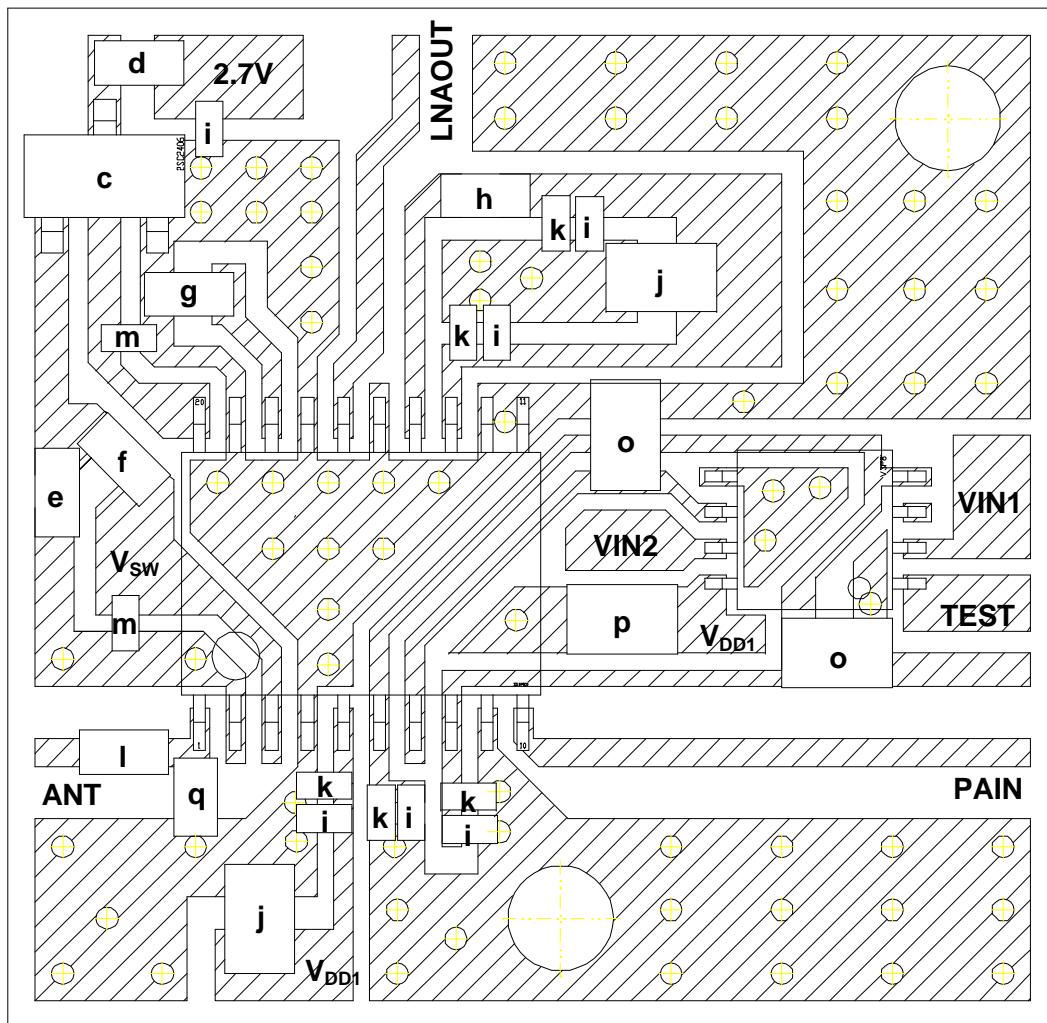

PCB SIZE 18.5 x 19mm

PCB: FR4 t=0.2mm

STRIP LINE WIDTH=0.4mm ( $Z_0=50\Omega$ )

Table 1 Parts list

Part ID	Constant	Comment	Part ID	Constant	Comment
a	NJG1701V		l	1000pF	MURATA(GRM36)
b	NJU7663R		j	0.1uF	MURATA(GRM40)
c	2SC4713K		k	33pF	MURATA(GRM36)
d	47K $\Omega$	TAMA Electronics(CRG16G)	l	51pF	MURATA(GRM36)
e	100K $\Omega$	TAMA Electronics(CRG16G)	m	10pF	MURATA(GRM36)
f	270K $\Omega$	TAMA Electronics(CRG16G)	o	0.01uF	MURATA(GRM40)
g	3.3nH	TAIYO-YUDEN(HK1608)	p	1uF	MURATA(GRM40)
h	10nH	TAIYO-YUDEN(HK1608)	q	500K $\Omega$	TAMA Electronics(CRG16G)

Note: The following list shows pin number and parts that should be connected as close as possible.  
 #5 pin to k&i, #6 pin to k&l, #8 pin to k&l, #13 pin to k&i

# NJG1701V

## ■PACKAGE OUTLINE (SSOP20)

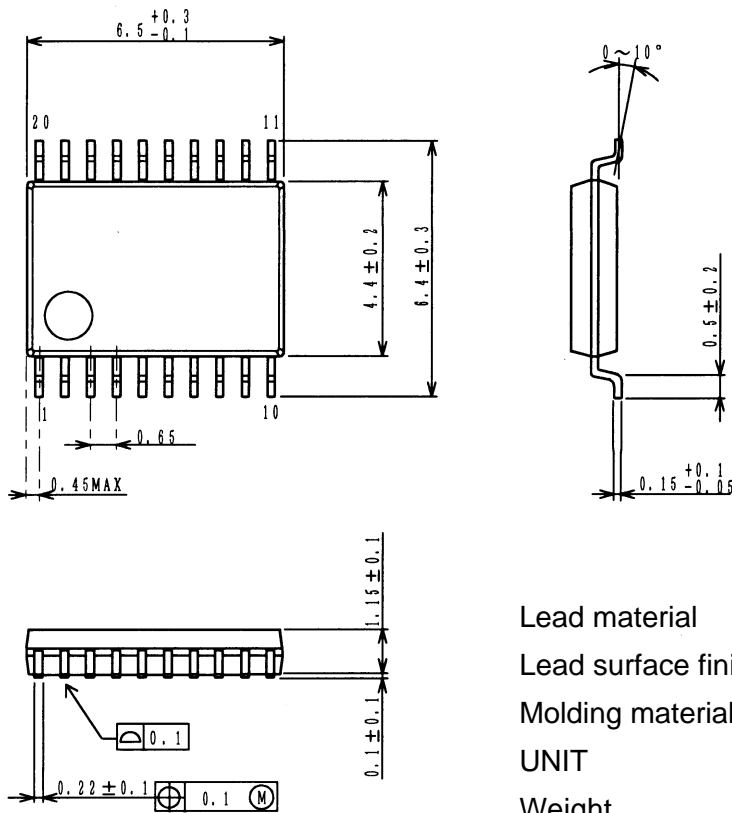

Lead material	: Copper
Lead surface finish	: Solder plating
Molding material	: Epoxy resin
UNIT	: mm
Weight	: 85mg

### Cautions on using this product

- This product contains Gallium-Arsenide (GaAs) which is a harmful material.
- Do NOT eat or put into mouth.
  - Do NOT dispose in fire or break up this product.
  - Do NOT chemically make gas or powder with this product.
  - To waste this product, please obey the relating law of your country.

### [CAUTION]

The specifications on this databook are only given for information, without any guarantee as regards either mistakes or omissions. The application circuits in this databook are described only to show representative usages of the product and not intended for the guarantee or permission of any right including the industrial rights.

This product may be damaged with electric static discharge (ESD) or spike voltage. Please handle with care to avoid these damages.



SUNSTAR 商斯达实业集团是集研发、生产、工程、销售、代理经销、技术咨询、信息服务等为一体的高科技企业，是专业高科技电子产品生产厂家，是具有 10 多年历史的专业电子元器件供应商，是中国最早和最大的仓储式连锁规模经营大型综合电子零部件代理分销商之一，是一家专业代理和分销世界各大品牌 IC 芯片和电子元器件的连锁经营综合性国际公司，专业经营进口、国产名厂名牌电子元件，型号、种类齐全。在香港、北京、深圳、上海、西安、成都等全国主要电子市场设有直属分公司和产品展示展销窗口门市部专卖店及代理分销商，已在全国范围内建成强大统一的供货和代理分销网络。我们专业代理经销、开发生产电子元器件、集成电路、传感器、微波光电元器件、工控机/DOC/DOM 电子盘、专用电路、单片机开发、MCU/DSP/ARM/FPGA 软件硬件、二极管、三极管、模块等，是您可靠的一站式现货配套供应商、方案提供商、部件功能模块开发配套商。商斯达实业公司拥有庞大的资料库，有数位毕业于著名高校——有中国电子工业摇篮之称的西安电子科技大学（西军电）并长期从事国防尖端科技研究的高级工程师为您精挑细选、量身订做各种高科技电子元器件，并解决各种技术问题。

微波光电部专业代理经销高频、微波、光纤、光电元器件、组件、部件、模块、整机；电磁兼容元器件、材料、设备；微波 CAD、EDA 软件、开发测试仿真工具；微波、光纤仪器仪表。欢迎国外高科技微波、光纤厂商将优秀产品介绍到中国、共同开拓市场。长期大量现货专业批发高频、微波、卫星、光纤、电视、CATV 器件：晶振、VCO、连接器、PIN 开关、变容二极管、开关二极管、低噪晶体管、功率电阻及电容、放大器、功率管、MMIC、混频器、耦合器、功分器、振荡器、合成器、衰减器、滤波器、隔离器、环行器、移相器、调制解调器；光电子器件和组件：红外发射管、红外接收管、光电开关、光敏管、发光二极管和发光二极管组件、半导体激光二极管和激光器组件、光电探测器和光接收组件、光发射接收模块、光纤激光器和光放大器、光调制器、光开关、DWDM 用光发射和接收器件、用户接入系统光收发器件与模块、光纤连接器、光纤跳线/尾纤、光衰减器、光纤适配器、光隔离器、光耦合器、光环行器、光复用器/转换器；无线收发芯片和模组、蓝牙芯片和模组。

更多产品请看本公司产品专用销售网站：

商斯达中国传感器科技信息网：<http://www.sensor-ic.com/>

商斯达工控安防网：<http://www.pc-ps.net/>

商斯达电子元器件网：<http://www.sunstare.com/>

商斯达微波光电产品网：[HTTP://www.rfoe.net/](http://www.rfoe.net/)

商斯达消费电子产品网：<http://www.icasic.com/>

商斯达实业科技产品网：<http://www.sunstars.cn/> 微波元器件销售热线：

地址：深圳市福田区福华路福庆街鸿图大厦 1602 室

电话：0755-82884100 83397033 83396822 83398585

传真：0755-83376182 (0) 13823648918 MSN: SUNS8888@hotmail.com

邮编：518033 E-mail:[szss20@163.com](mailto:szss20@163.com) QQ: 195847376

深圳赛格展销部：深圳华强北路赛格电子市场 2583 号 电话：0755-83665529 25059422

技术支持：0755-83394033 13501568376

欢迎索取免费详细资料、设计指南和光盘；产品凡多，未能尽录，欢迎来电查询。

北京分公司：北京海淀区知春路 132 号中发电子大厦 3097 号

TEL: 010-81159046 82615020 13501189838 FAX: 010-62543996

上海分公司：上海市北京东路 668 号上海赛格电子市场 D125 号

TEL: 021-28311762 56703037 13701955389 FAX: 021-56703037

西安分公司：西安高新开发区 20 所(中国电子科技集团导航技术研究所)

西安劳动南路 88 号电子商城二楼 D23 号

TEL: 029-81022619 13072977981 FAX:029-88789382