



# NJG1704V

## ■ABSOLUTE MAXIMUM RATINGS

( $T_a=+25^{\circ}\text{C}$ ,  $Z_s=Z_i=50\Omega$ )

PARAMETER	SYMBOL	CONDITIONS	RATINGS	UNITS
LNA Voltage	$V_{LNA}$		5.0	V
MIXER Voltage	$V_{MIX}$		5.0	V
LOCAL Amplifier Voltage	$V_{LO}$		5.0	V
Input Power 1	$P_{LNAIN}$	$V_{LNA}=V_{MIX}=V_{LO}=2.7V$	+15	dBm
Input Power 2	$P_{LOIN}$	$V_{LNA}=V_{MIX}=V_{LO}=2.7V$	+10	dBm
Power Dissipation	$P_D$		320	mW
Operating Temperature	$T_{opr}$		-40~+85	$^{\circ}\text{C}$
Storage Temperature	$T_{std}$		-55~+125	$^{\circ}\text{C}$

## ■ELECTRICAL CHARACTERISTICS

COMMON CONDITIONS:  $T_a=+25^{\circ}\text{C}$ ,  $V_{LNA}=V_{MIX}=V_{LO}=2.7V$ ,  $f_{RF}=820\text{MHz}$ ,  $f_{LO}=690\text{MHz}$ ,  $P_{RF}=-50\text{dBm}$ ,  $P_{LO}=-10\text{dBm}$ ,  $Z_s=Z_i=50\Omega$ , Application Circuit,  $f_{LO}=690\text{MHz}$

PARAMETER	SYMBOL	CONDITIONS	MIN	TYP	MAX	UNITS
Operating Frequency	Freq		800	820	900	MHz
LNA Voltage	$V_{LNA}$		2.5	2.7	4.5	V
MIXER Voltage	$V_{MIX}$		2.5	2.7	4.5	V
LOCAL Amplifier Voltage	$V_{LO}$		2.5	2.7	4.5	V
LNA Current	$I_{LNA}$	$P_{RF}, P_{LO}=\text{OFF}$	-	3.0	4.5	mA
MIXER Current	$I_{MIX}$	$P_{RF}, P_{LO}=\text{OFF}$	-	5.0	6.7	mA
LOCAL Amplifier Current	$I_{LO}$	$P_{RF}, P_{LO}=\text{OFF}$	-	1.0	2.0	mA
Total Current	$I_{AL}$	$P_{RF}, P_{LO}=\text{OFF}$	-	9.0	13.2	mA
Conversion Gain	$G_c$		25.0	28.0	-	dB
Gain Flatness	$G_{flat}$	30MHz bandwidth in $f_{RF}=810\sim 885\text{MHz}$	-	1.5	-	dB
Noise Figure	NF		-	1.7	2.0	dB
1dB Gain Compression Output Power	P-1dB		-1.0	+2.5	-	dBm
Input 3rd Intercept Point	IIP3	$f_{RF}=820.0+820.1\text{MHz}$	-19.0	-14.0	-	dBm
Image Suppression Level	IMR		-	-22.0	-18.0	dBc
RF IN VSWR	$VSWR_i$		-	2.0	3.0	

## ■ ELECTRICAL CHARACTERISTICS (LNA)

COMMON CONDITIONS:  $T_a=+25^{\circ}\text{C}$ ,  $V_{\text{LNA}}=2.7\text{V}$ ,  $V_{\text{MIX}}=V_{\text{LO}}=0\text{V}$ ,  $f_{\text{RF}}=820\text{MHz}$ ,  $Z_s=Z_i=50\Omega$   
 Application Circuit,  $f_{\text{LO}}=690\text{MHz}$

PARAMETER	SYMBOL	CONDITIONS	MIN	TYP	MAX	UNITS
Small Signal Gain	Gain		-	16.0	-	dB
Noise Figure	NF		-	1.4	-	dB
Input 3'rd Intercept Point	IIP3	$f_{\text{RF}}=820.0+820.1\text{MHz}$	-	-3.0	-	dBm
RF IN VSWR	$\text{VSWR}_i$		-	2.0	-	
RF OUT VSWR	$\text{VSWR}_o$		-	2.0	-	

## ■ ELECTRICAL CHARACTERISTICS (MIXER)

COMMON CONDITIONS:  $T_a=+25^{\circ}\text{C}$ ,  $V_{\text{LNA}}=0\text{V}$ ,  $V_{\text{MIX}}=V_{\text{LO}}=2.7\text{V}$ ,  $f_{\text{RF}}=820\text{MHz}$ ,  $f_{\text{LO}}=690\text{MHz}$ ,  
 $P_{\text{RF}}=-30\text{dBm}$ ,  $P_{\text{LO}}=-10\text{dBm}$ ,  $Z_s=Z_i=50\Omega$  Application Circuit,  $f_{\text{LO}}=690\text{MHz}$

PARAMETER	SYMBOL	CONDITIONS	MIN	TYP	MAX	UNITS
Conversion Gain	$G_c$		-	12.0	-	dB
Noise Figure	NF		-	5.0	-	dB
Input 3'rd Intercept Point	IIP3	$f_{\text{RF}}=820.0+820.1\text{MHz}$	-	+2.0	-	dBm

## ■TERMINAL INFORMATION

No.	SYMBOL	DESCRIPTIONS
1	LNAIN	RF input terminal of LNA. The RF signal is input through external matching circuit.
2	LNACAP	Terminal for the bypass capacitor of LNA. The bypass capacitor C1 shown in application circuit, should be connected to this terminal as close as possible.
3	GND	Ground terminal(0V)
4	IFOUT	IF signal output terminal. The IF signal is output though external matching circuit's connected to this terminal. Please connect inductance L8 and power supply as application circuit since it is also the terminal of Mixer power supply.
5	VLO	Power supply terminal for local amplifier. Please connect R1 and L10 to this terminal shown in the application circuit as close as possible.
6	LOIN	Local signal input terminal of local amplifier. The local signal input to Local Amplifier through external matching circuit.
7	GND	Ground terminal(0V)
8	MIXIN	RF signal input terminal of Mixer. The RF signal from LNA is sent to Mixer through matching circuit.
9	GND	Ground terminal(0V)
10	LNAOUT	Signal output terminal of LNA. The RF signal from LNA is output through external matching circuit connected to this terminal. Please connect inductance L4 and power supply shown in application circuit, since it is also the terminal of LNA power supply.

### CAUTION

- 1) Ground terminal (No.3, 7, 9) should be connected to the ground plane as short as possible.

## ■ TYPICAL CHARACTERISTICS (LNA+MIXER, $f_{LO}=690\text{MHz}$ )

### Conversion Gain , Noise Figure vs. RF Frequency

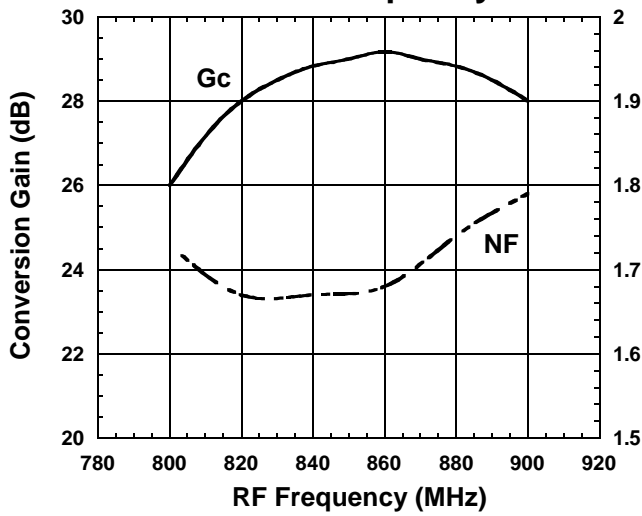

Condition  
 $f_{IF}=130\text{MHz}$   
 $P_{RF}=-46\text{dBm}$   
 $P_{LO}=-10\text{dBm}$   
 $V_{LNA}=V_{MIX}=V_{LO}=2.7\text{V}$

### Conversion Gain , Noise Figure vs. LO Power

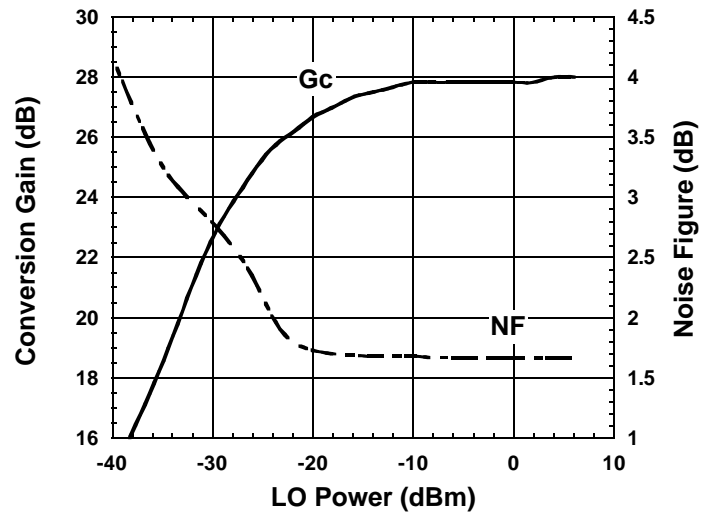

Condition  
 $f_{IF}=130\text{MHz}$   
 $f_{RF}=820\text{MHz}$ ,  $P_{RF}=-46\text{dBm}$   
 $f_{LO}=690\text{MHz}$   
 $V_{LNA}=V_{MIX}=V_{LO}=2.7\text{V}$

### Output-IP3 , Input-IP3 vs. LO Power

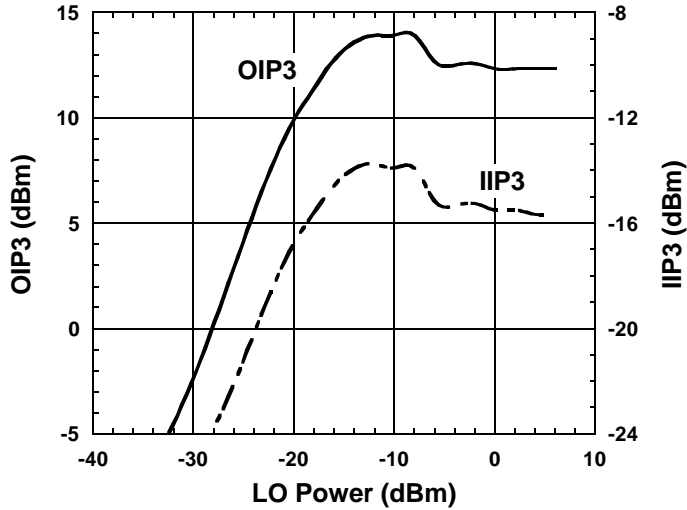

Condition  
 $f_{IF}=130\text{MHz}$   
 $f_{RF1}=820.0\text{MHz}$ ,  $P_{RF}=-42\text{dBm}$   
 $f_{RF2}=820.1\text{MHz}$   
 $f_{LO}=690\text{MHz}$   
 $V_{LNA}=V_{MIX}=V_{LO}=2.7\text{V}$

$$OIP3 = \frac{3IF-IM3}{2}$$

$$IIP3 = \frac{3IF-IM3}{2} - G_c$$

@  $P_{RF}=-42\text{dBm}$

# NJG1704V

## ■ TYPICAL CHARACTERISTICS (LNA+MIXER, $f_{LO}=690\text{MHz}$ )

### RF IN IMPEDANCE

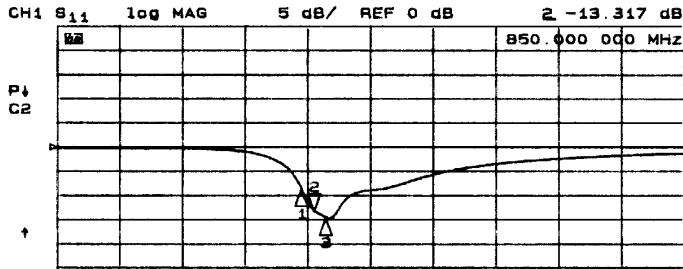

C2 MARKER 2  
850 MHz

START 50.000 000 MHz STOP 2 000.000 000 MHz

Condition  
 $V_{LNA}=2.7\text{V}$   
 $V_{MIX}=V_{LO}=2.7\text{V}$   
 Marker1: 810MHz  
 Marker2: 850MHz  
 Marker3: 885MHz

### LOCAL IN IMPEDANCE

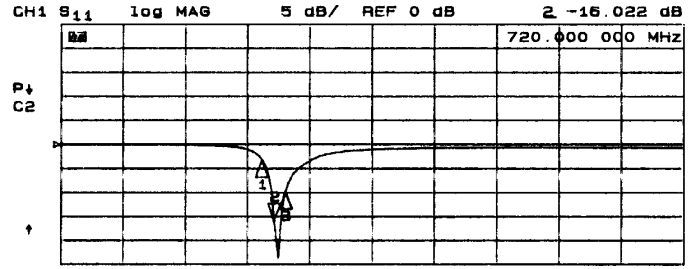

C2 MARKER 2  
720 MHz

START 50.000 000 MHz STOP 2 000.000 000 MHz

Condition  
 $V_{LNA}=2.7\text{V}$   
 $V_{MIX}=V_{LO}=2.7\text{V}$   
 Marker1: 680MHz  
 Marker2: 720MHz  
 Marker3: 755MHz

### IF OUT IMPEDANCE

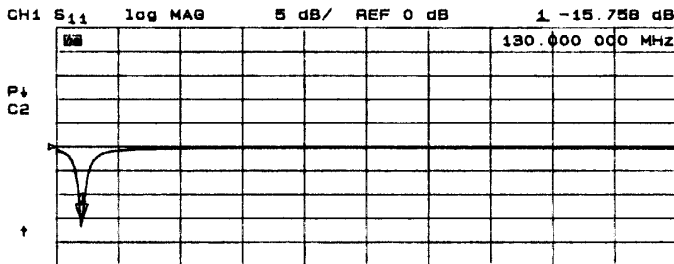

C2 MARKER 1  
130 MHz

START 50.000 000 MHz STOP 2 000.000 000 MHz

Condition  
 $V_{LNA}=2.7\text{V}$   
 $V_{MIX}=V_{LO}=2.7\text{V}$

## ■ TYPICAL CHARACTERISTICS (LNA+MIXER, $f_{LO}=690\text{MHz}$ )

### Conversion Gain , Noise Figure vs. $V_{LNA}, V_{MIX}, V_{LO}$

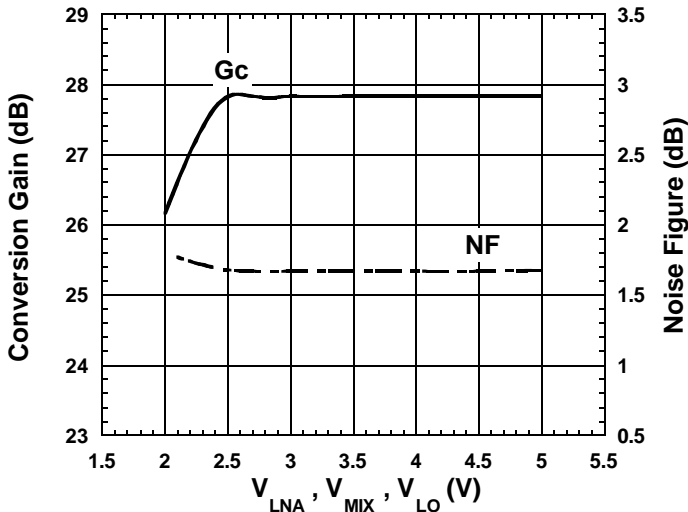

Condition  
 $f_{IF}=130\text{MHz}$   
 $f_{RF}=820\text{MHz}, P_{RF}=-46\text{dBm}$   
 $f_{LO}=690\text{MHz}, P_{LO}=-10\text{dBm}$

### Output-IP3 , Input-IP3 vs. $V_{LNA}, V_{MIX}, V_{LO}$

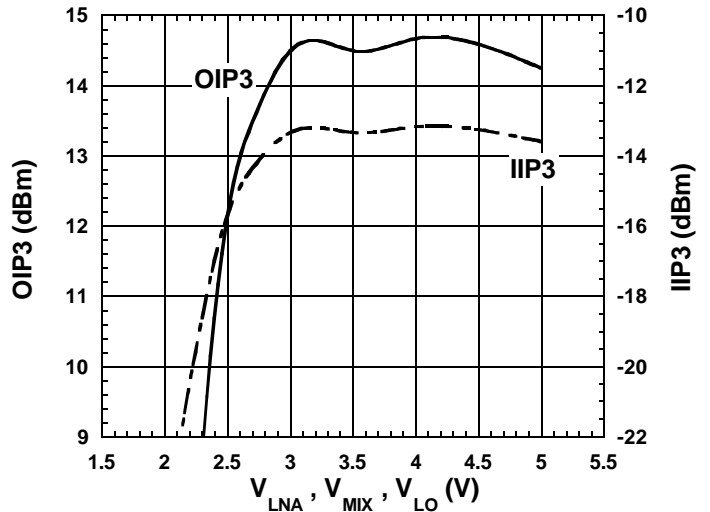

Condition  
 $f_{IF}=130\text{MHz}$   
 $f_{RF1}=820.0\text{MHz}, P_{RF}=-42\text{dBm}$   
 $f_{RF2}=820.1\text{MHz}$   
 $f_{LO}=690\text{MHz}, P_{LO}=-10\text{dBm}$

$$OIP3 = \frac{3IF - IM3}{2}$$

$$IIP3 = \frac{3IF - IM3}{2} - G_c$$

@  $P_{RF}=-42\text{dBm}$

### IF , IM3 vs. RF Power

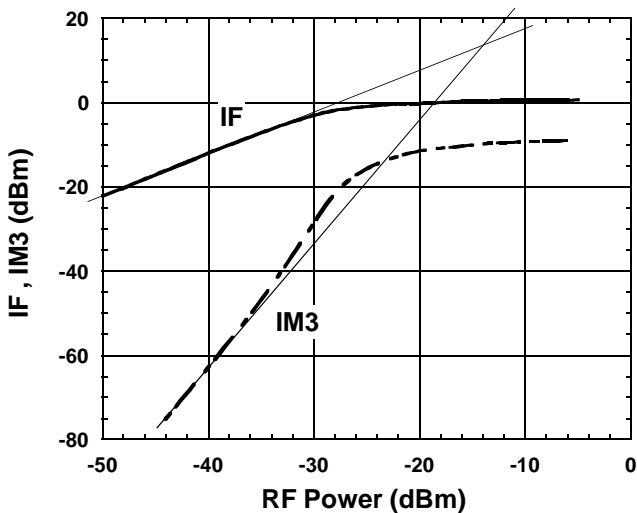

Condition  
 $f_{IF}=130\text{MHz}$   
 $f_{RF1}=820.0\text{MHz}$   
 $f_{RF2}=820.1\text{MHz}$   
 $f_{LO}=690\text{MHz}, P_{LO}=-10\text{dBm}$   
 $V_{LNA}=V_{MIX}=V_{LO}=2.7\text{V}$

### IF vs. RF Power

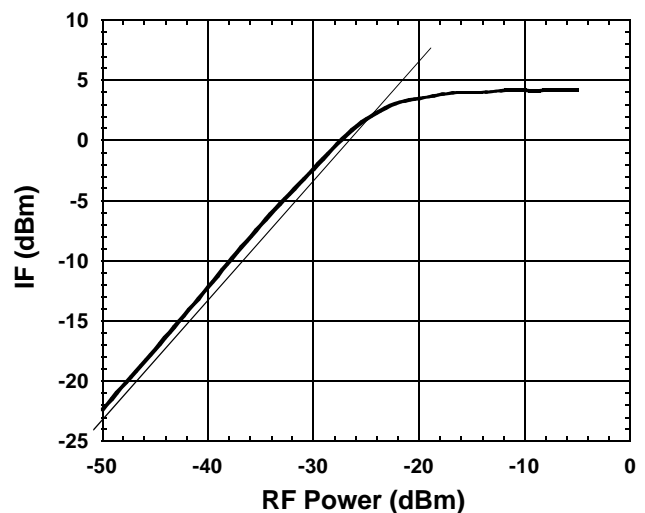

Condition  
 $f_{IF}=130\text{MHz}$   
 $f_{RF}=820\text{MHz}$   
 $f_{LO}=690\text{MHz}, P_{LO}=-10\text{dBm}$   
 $V_{LNA}=V_{MIX}=V_{LO}=2.7\text{V}$

# NJG1704V

## ■ TYPICAL CHARACTERISTICS (LNA+MIXER, $f_{LO}=690\text{MHz}$ )

### Conversion Gain , Noise Figure vs. Temperature

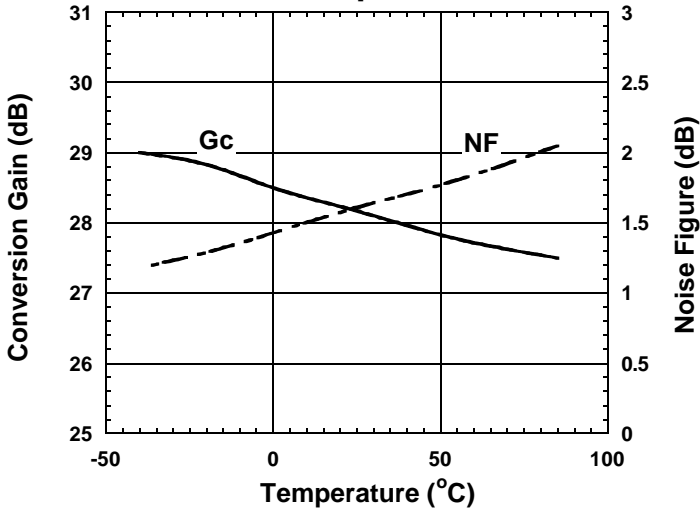

Condition  
 $f_{IF}=130\text{MHz}$   
 $f_{RF}=820\text{MHz}$ ,  $P_{RF}=-46\text{dBm}$   
 $f_{LO}=690\text{MHz}$ ,  $P_{LO}=-10\text{dBm}$   
 $V_{LNA}=V_{MIX}=V_{LO}=2.7\text{V}$

### Output-IP3 , Input-IP3 vs. Temperature

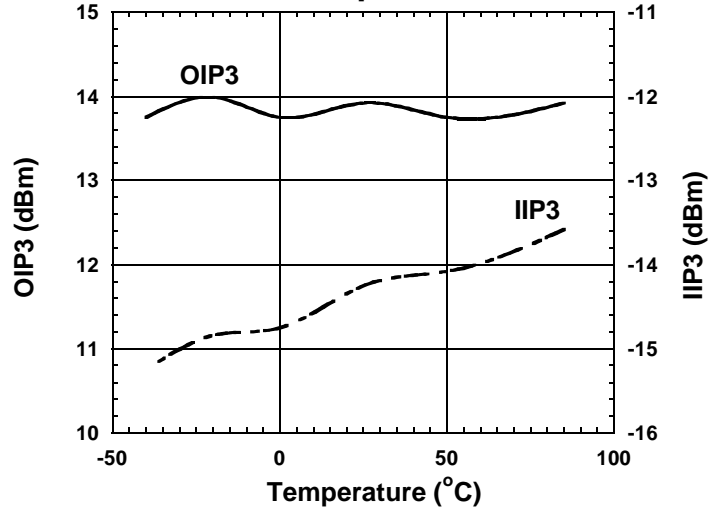

Condition  
 $f_{IF}=130\text{MHz}$   
 $f_{RF1}=820.0\text{MHz}$ ,  $P_{RF}=-42\text{dBm}$   
 $f_{RF2}=820.1\text{MHz}$   
 $f_{LO}=690\text{MHz}$   
 $V_{LNA}=V_{MIX}=V_{LO}=2.7\text{V}$

$$OIP3 = \frac{3IF-IM3}{2}$$

$$IIP3 = \frac{3IF-IM3}{2} - G_c$$

@  $P_{RF}=-42\text{dBm}$

### $I_{LNA}$ , $I_{MIX}$ , $I_{LO}$ vs. Temperature

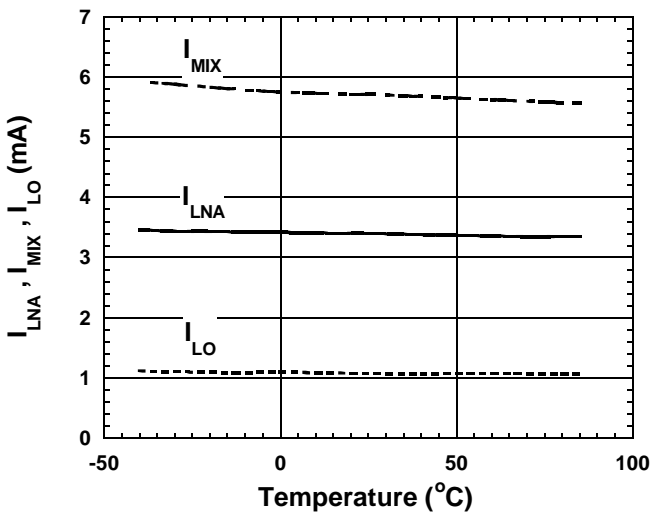

Condition  
 $P_{RF}=\text{OFF}$   
 $P_{LO}=\text{OFF}$   
 $V_{LNA}=V_{MIX}=V_{LO}=2.7\text{V}$



## ■ TYPICAL CHARACTERISTICS (LNA+MIXER, $f_{LO}=690\text{MHz}$ )

### RF IN - LOCAL IN ISOLATION (RF IN-LOCAL IN)

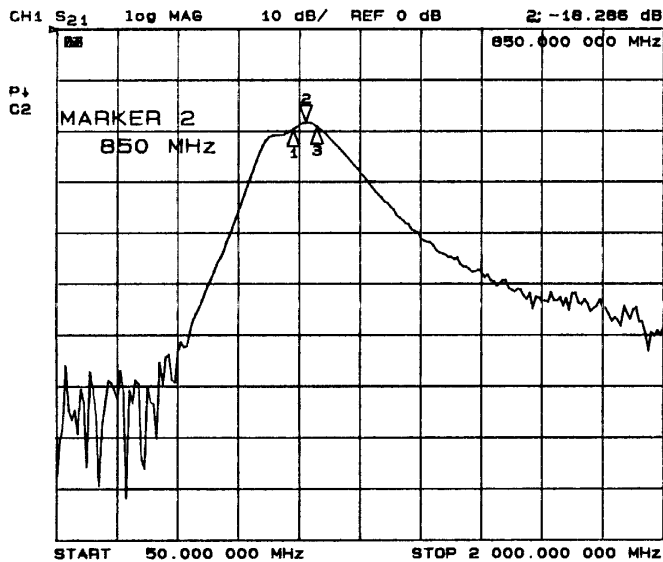

Condition  
 $V_{LNA}=2.7\text{V}$  Marker1: 810MHz  
 $V_{MIX}=V_{LO}=2.7\text{V}$  Marker2: 850MHz  
 Port1: RF IN Marker3: 885MHz  
 Port2: LOCAL IN

### RF OUT - MIXER IN ISOLATION (RF OUT-MIXER IN)

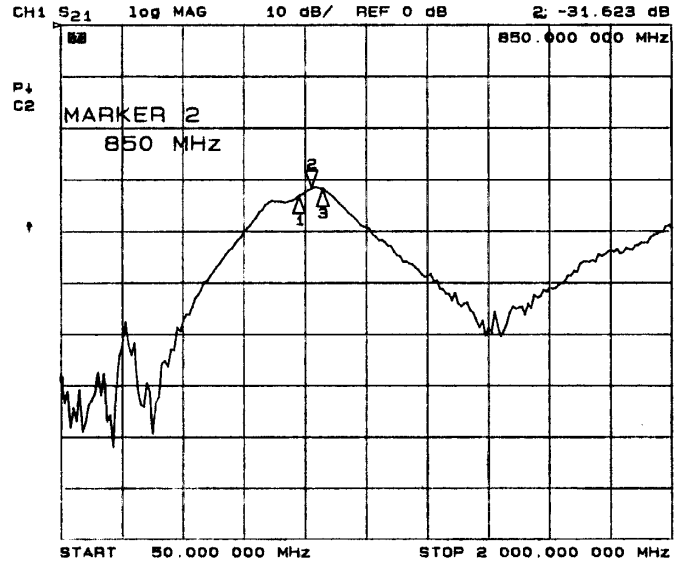

Condition  
 $V_{LNA}=2.7\text{V}$  Marker1: 810MHz  
 $V_{MIX}=V_{LO}=2.7\text{V}$  Marker2: 850MHz  
 Port1: RF OUT Marker3: 885MHz  
 Port2: MIXER IN

## ■ TYPICAL CHARACTERISTICS (LNA+MIXER $f_{LO}=1016.7\text{MHz}$ )

### Conversion Gain , Noise Figure vs. RF Frequency

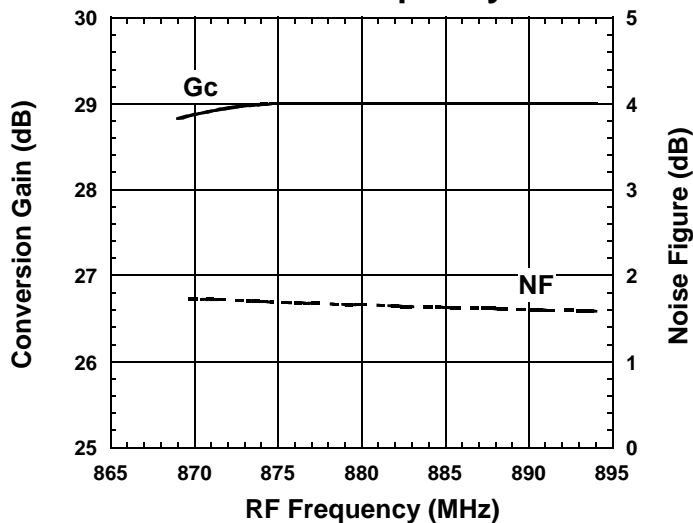

Condition  
 $f_{IF}=135.2\text{MHz}$   
 $P_{RF}=-50\text{dBm}$   
 $P_{LO}=-8\text{dBm}$   
 $V_{LNA}=V_{MIX}=V_{LO}=3.0\text{V}$   
 Upper LOCAL

### IF , IM3 vs. RF Power

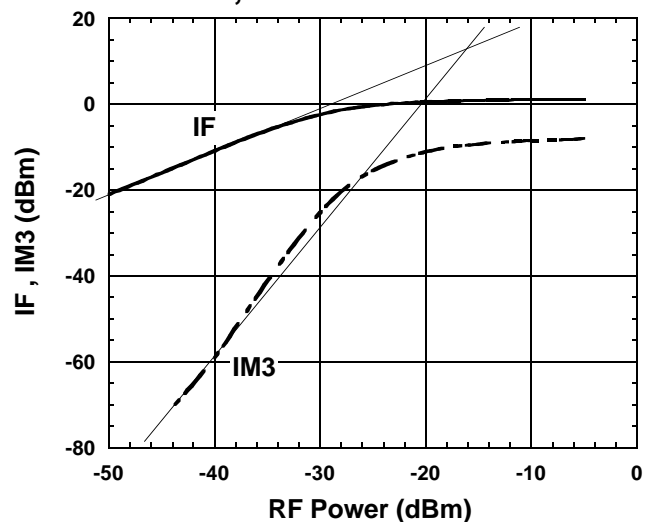

Condition  
 $f_{IF}=135.2\text{MHz}$   
 $f_{RF1}=881.5\text{MHz}$   
 $f_{RF2}=881.6\text{MHz}$   
 $f_{LO}=1016.7\text{MHz}, P_{LO}=-8\text{dBm}$   
 $V_{LNA}=V_{MIX}=V_{LO}=3.0\text{V}$

# NJG1704V

## TYPICAL CHARACTERISTICS (LNA)

### SMALL SIGNAL GAIN (S21)

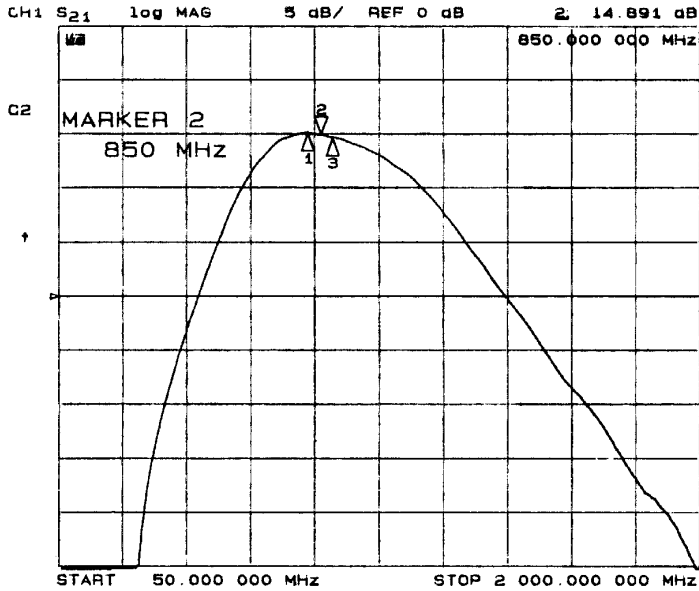

Condition  
 $V_{LNA}=2.7V$   
 $V_{MIX}=V_{LO}=0V$

Marker1:810MHz  
 Marker2:850MHz  
 Marker3:885MHz

### RF IN RETURN LOSS (S11)

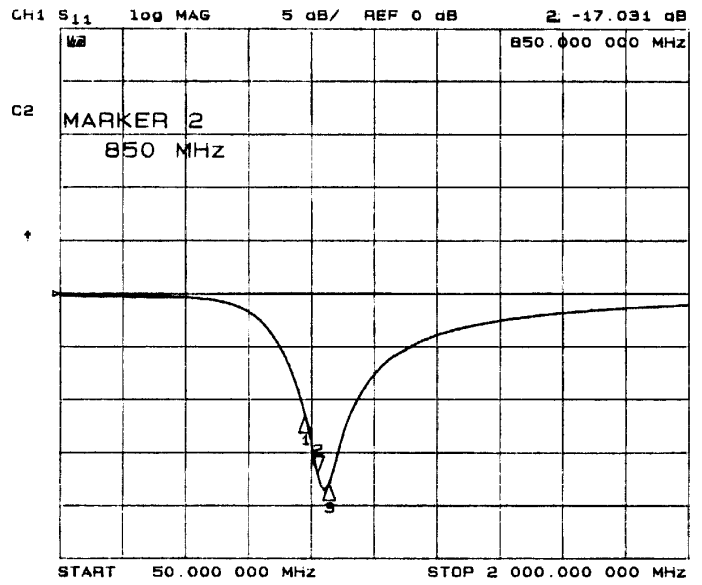

Condition  
 $V_{LNA}=2.7V$   
 $V_{MIX}=V_{LO}=0V$

Marker1:810MHz  
 Marker2:850MHz  
 Marker3:885MHz

### RF OUT RETURN LOSS (S22)

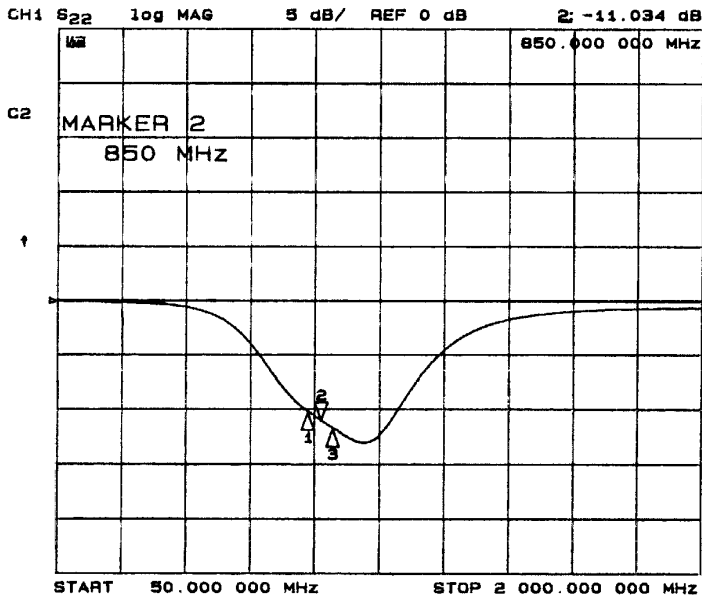

Condition  
 $V_{LNA}=2.7V$   
 $V_{MIX}=V_{LO}=0V$

Marker1:810MHz  
 Marker2:850MHz  
 Marker3:885MHz

### ISOLATION (S12)

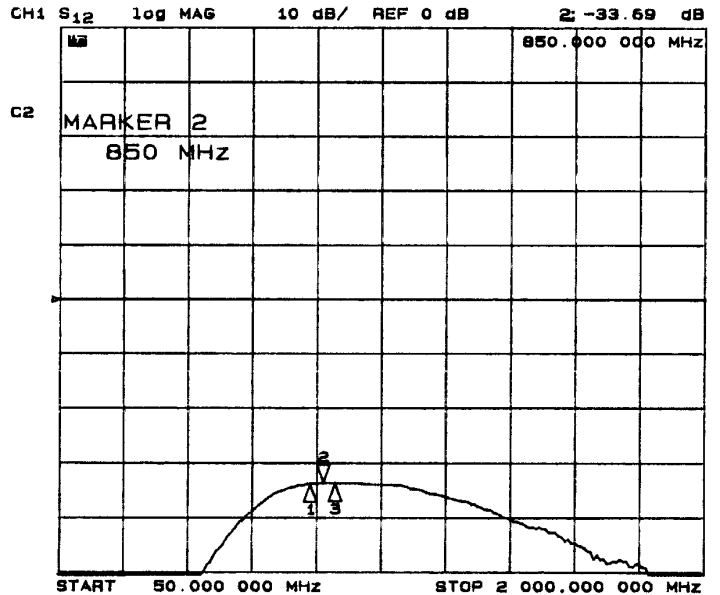

Condition  
 $V_{LNA}=2.7V$   
 $V_{MIX}=V_{LO}=0V$

Marker1:810MHz  
 Marker2:850MHz  
 Marker3:885MHz

## ■ TYPICAL CHARACTERISTICS (LNA)

### Noise Figure vs. RF Frequency

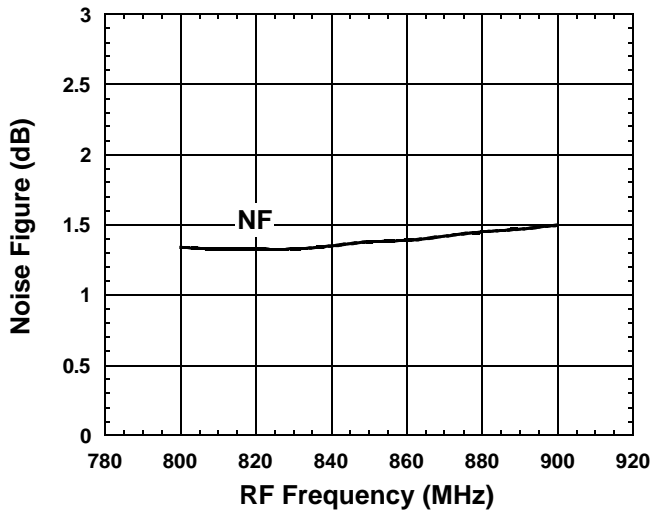

Condition  
 $V_{LNA}=2.7V$   
 $V_{MIX}=V_{LO}=0V$

### Pout, IM3 vs. RF Power

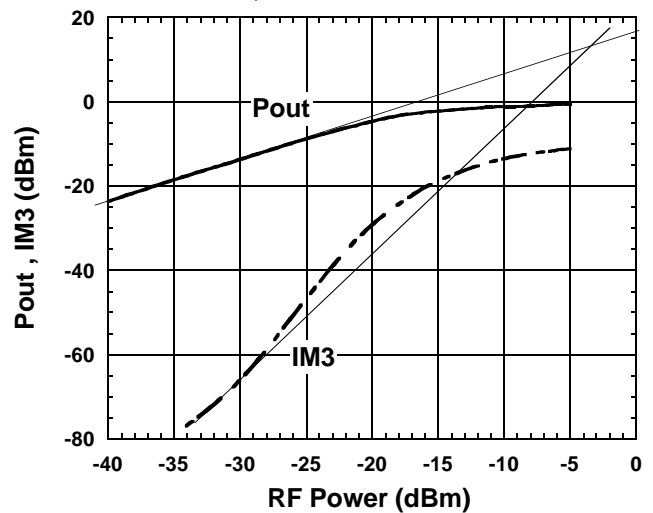

Condition  
 $f_{RF}=820.0+820.1MHz$   
 $V_{LNA}=2.7V$   
 $V_{MIX}=V_{LO}=0V$

## ■ TYPICAL CHARACTERISTICS (MIXER)

### Conversion Gain, Noise Figure vs. RF Frequency

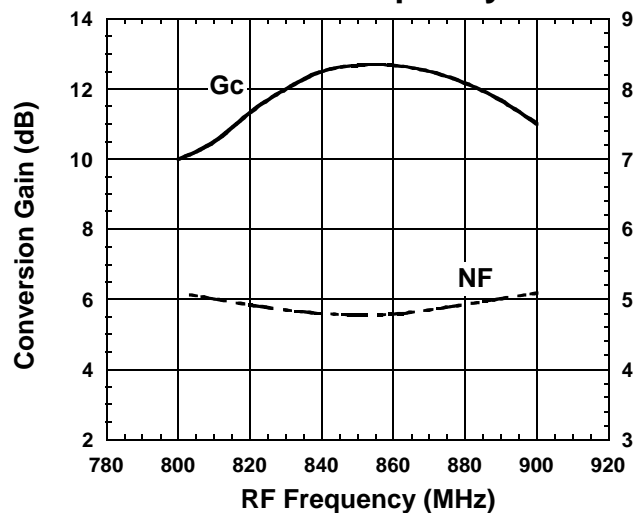

Condition  
 $f_{IF}=130MHz$   
 $P_{RF}=-30dBm$   
 $P_{LO}=-10dBm$   
 $V_{LNA}=0V$   
 $V_{MIX}=V_{LO}=2.7V$

### IF, IM3 vs. RF Power

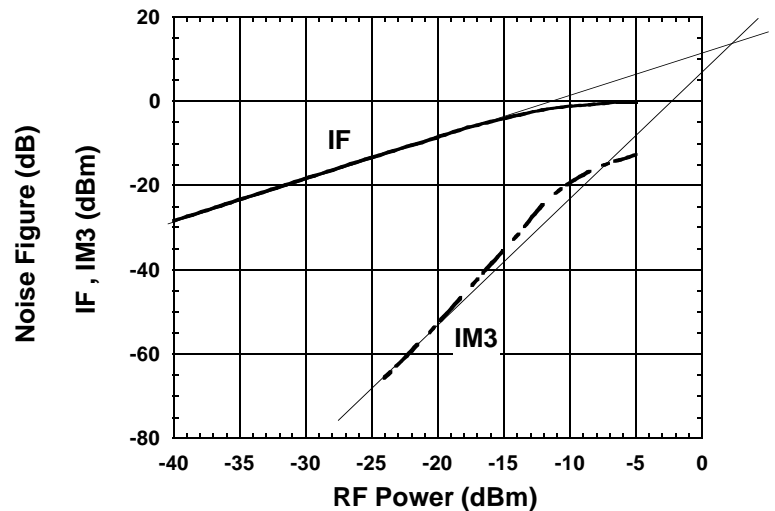

Condition  
 $f_{IF}=130MHz$   
 $f_{RF}=820MHz, P_{RF}=-30dBm$   
 $f_{LO}=690MHz$   
 $V_{LNA}=0V$   
 $V_{MIX}=V_{LO}=2.7V$

# NJG1704V

## ■ TYPICAL CHARACTERISTICS (MIXER, $f_{LO}=690\text{MHz}$ )

### MIXER IN IMPEDANCE

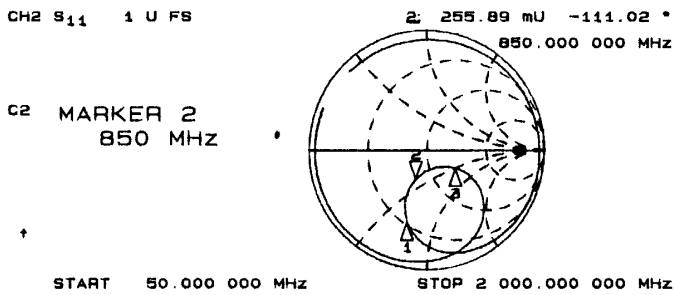
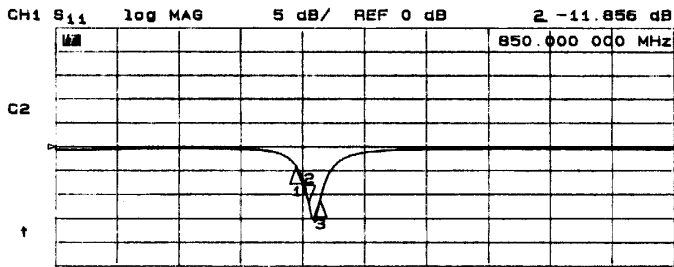

Condition  
 $V_{LNA}=0\text{V}$   
 $V_{MIX}=V_{LO}=2.7\text{V}$   
 Marker1:810MHz  
 Marker2:850MHz  
 Marker3:885MHz

### LOCAL IN IMPEDANCE

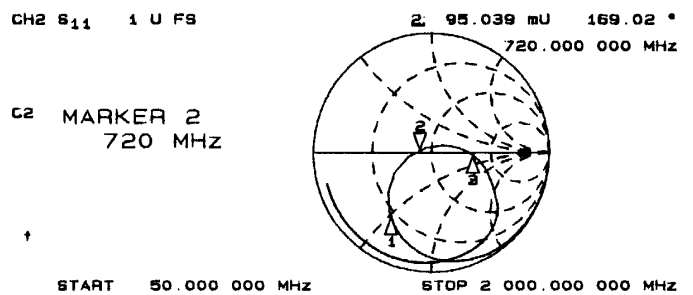
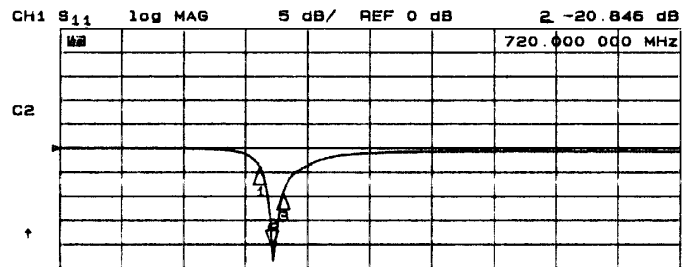

Condition  
 $V_{LNA}=0\text{V}$   
 $V_{MIX}=V_{LO}=2.7\text{V}$   
 Marker1:680MHz  
 Marker2:720MHz  
 Marker3:755MHz

### IF OUT IMPEDANCE

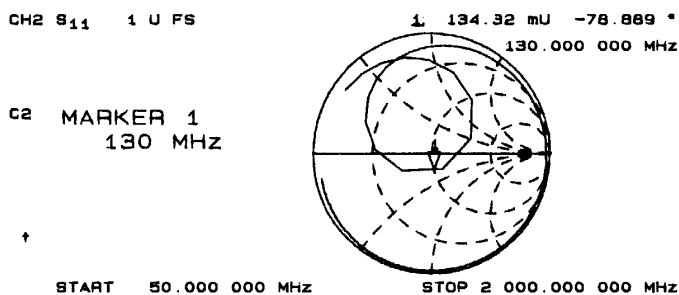
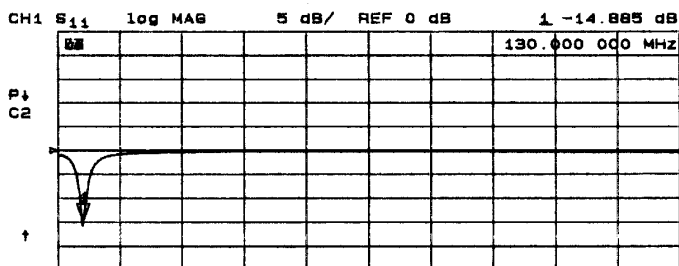

Condition  
 $V_{LNA}=0\text{V}$   
 $V_{MIX}=V_{LO}=2.7\text{V}$

## APPLICATION CIRCUIT

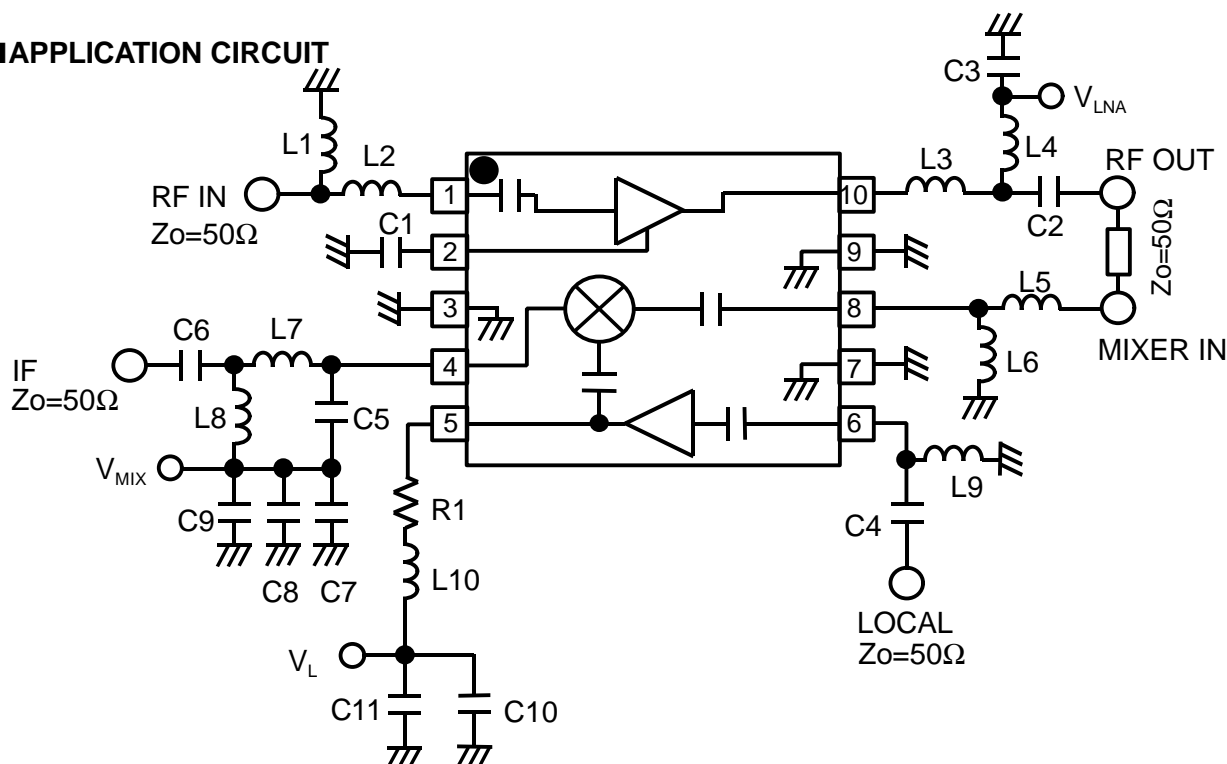

### PARTS LIST

PART ID	800MHz band			COMMENT
	Lower LOCAL	Upper LOCAL	Upper LOCAL	
	$f_{LO}=690\text{MHz}$ $f_{IF}=130\text{MHz}$	$f_{LO}=950\text{MHz}$ $f_{IF}=130\text{MHz}$	$f_{LO}=1016.7\text{MHz}$ $f_{IF}=135.2\text{MHz}$	
L1	12nH	12nH	12nH	TAIYO-YUDEN (HK1608)
L2	15nH	15nH	15nH	TAIYO-YUDEN (HK1608)
L3	27nH	27nH	27nH	TAIYO-YUDEN (HK1005)
L4	12nH	12nH	12nH	TAIYO-YUDEN (HK1005)
L5	33nH	33nH	27nH	TAIYO-YUDEN (HK1005)
L6	22nH	22nH	22nH	TAIYO-YUDEN (HK1005)
L7	100nH	100nH	100nH	TAIYO-YUDEN (HK1608)
L8	56nH	56nH	47nH	TAIYO-YUDEN (HK1608)
L9	22nH	15nH	12nH	TAIYO-YUDEN (HK1005)
L10	33nH	33nH	22nH	TAIYO-YUDEN (HK1005)
C1	24pF	24pF	24pF	MURATA (GRM36)
C2	4pF	4pF	4pF	MURATA (GRM36)
C3	1000pF	1000pF	1000pF	MURATA (GRM36)
C4	1pF	1pF	1pF	MURATA (GRM36)
C5	9pF	9pF	9pF	MURATA (GRM36)
C6	1000pF	1000pF	1000pF	MURATA (GRM36)
C7	10pF	10pF	10pF	MURATA (GRM36)
C8	100pF	100pF	100pF	MURATA (GRM36)
C9	1000pF	1000pF	1000pF	MURATA (GRM36)
C10	100pF	100pF	100pF	MURATA (GRM36)
C11	1000pF	1000pF	1000pF	MURATA (GRM36)
R1	22Ω	22Ω	22Ω	TAMA Electronics (CRG16G)

\* L1 and L2 are possible to use swaller chip, but NF will be worce.

# NJG1704V

## RECOMMENDED PCB DESIGN

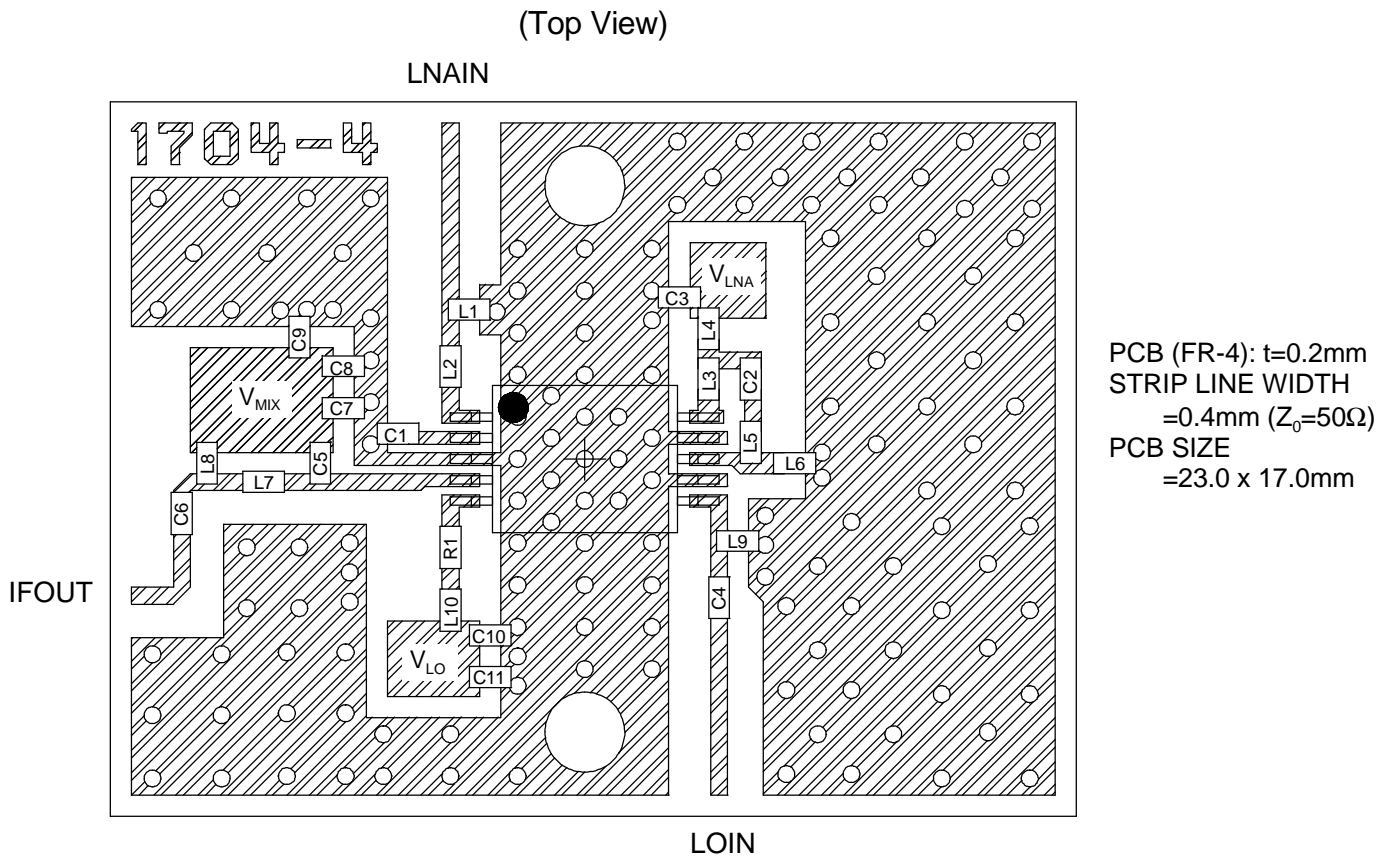

Caution on using devices.

- [ 1 ] Please place R1 close to the V<sub>Lo</sub> terminal (5th pin), and L10 to the R1.
- [ 2 ] Please place C1 close to the LNACAP terminal (2nd pin)
- [ 3 ] Please place C3 close to L4.
- [ 4 ] Please place C5 close to C7, C8, and C9.
- [ 5 ] Please place L10 close to C10, C11.

## MEASURING BLOCK DIAGRAM

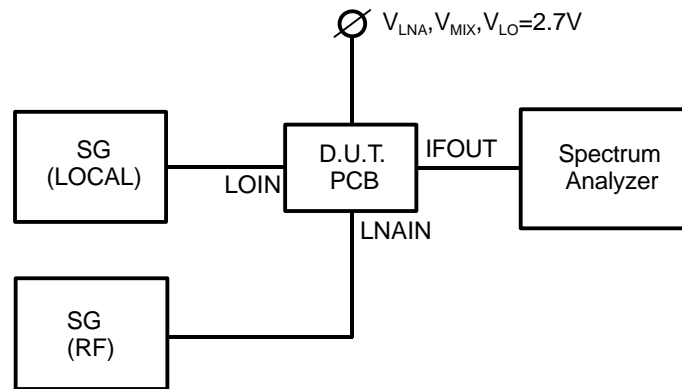

Conversion Gain Measurement Block Diagram

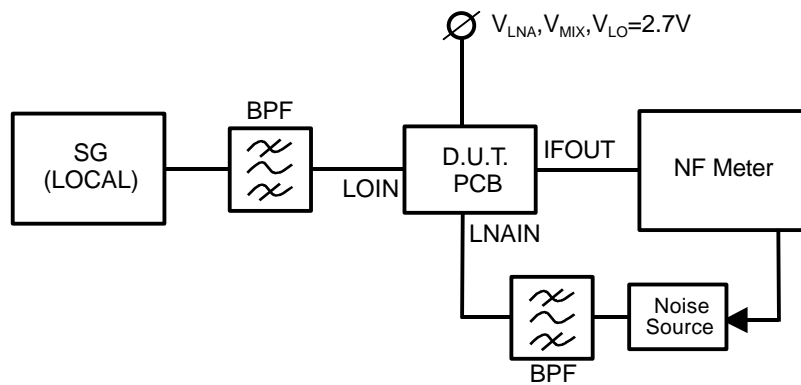

Noise Figure Measurement Block Diagram

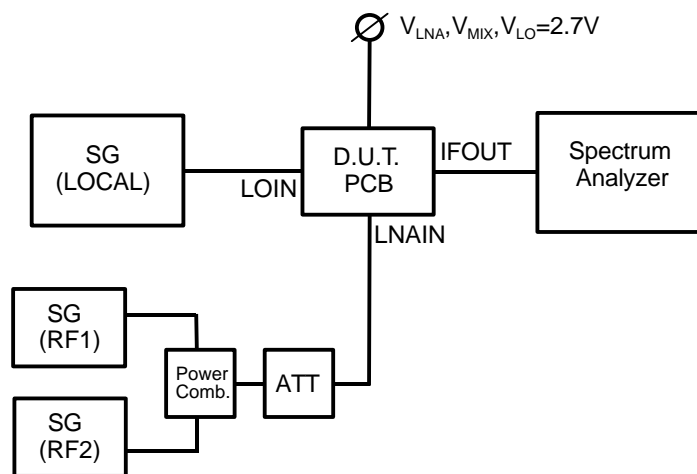

IF, IM3, IM5 Measurement Block Diagram

# NJG1704V

## PACKAGE OUTLINE (SSOP10)

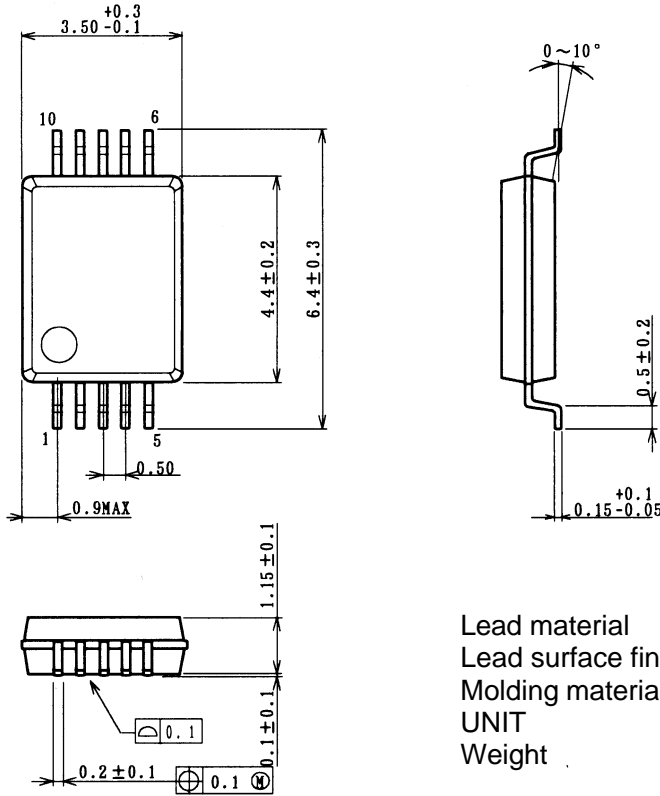

Lead material	: Copper
Lead surface finish	: Solder plating
Molding material	: Epoxy resin
UNIT	: mm
Weight	: 41mg

### Cautions on using this product

This product contains Gallium-Arsenide (GaAs) which is a harmful material.

- Do NOT eat or put into mouth.
- Do NOT dispose in fire or break up this product.
- Do NOT chemically make gas or powder with this product.
- To waste this product, please obey the relating law of your country.

### [CAUTION]

The specifications on this databook are only given for information, without any guarantee as regards either mistakes or omissions. The application circuits in this databook are described only to show representative usages of the product and not intended for the guarantee or permission of any right including the industrial rights.

This product may be damaged with electric static discharge (ESD) or spike voltage. Please handle with care to avoid these damages.



SUNSTAR 商斯达实业集团是集研发、生产、工程、销售、代理经销、技术咨询、信息服务等为一体的高科技企业，是专业高科技电子产品生产厂家，是具有 10 多年历史的专业电子元器件供应商，是中国最早和最大的仓储式连锁规模经营大型综合电子零部件代理分销商之一，是一家专业代理和分销世界各大品牌 IC 芯片和电子元器件的连锁经营综合性国际公司，专业经营进口、国产名厂名牌电子元件，型号、种类齐全。在香港、北京、深圳、上海、西安、成都等全国主要电子市场设有直属分公司和产品展示展销窗口门市部专卖店及代理分销商，已在全国范围内建成强大统一的供货和代理分销网络。我们专业代理经销、开发生产电子元器件、集成电路、传感器、微波光电元器件、工控机/DOC/DOM 电子盘、专用电路、单片机开发、MCU/DSP/ARM/FPGA 软件硬件、二极管、三极管、模块等，是您可靠的一站式现货配套供应商、方案提供商、部件功能模块开发配套商。商斯达实业公司拥有庞大的资料库，有数位毕业于著名高校——有中国电子工业摇篮之称的西安电子科技大学（西军电）并长期从事国防尖端科技研究的高级工程师为您精挑细选、量身订做各种高科技电子元器件，并解决各种技术问题。

微波光电部专业代理经销高频、微波、光纤、光电元器件、组件、部件、模块、整机；电磁兼容元器件、材料、设备；微波 CAD、EDA 软件、开发测试仿真工具；微波、光纤仪器仪表。欢迎国外高科技微波、光纤厂商将优秀产品介绍到中国、共同开拓市场。长期大量现货专业批发高频、微波、卫星、光纤、电视、CATV 器件：晶振、VCO、连接器、PIN 开关、变容二极管、开关二极管、低噪晶体管、功率电阻及电容、放大器、功率管、MMIC、混频器、耦合器、功分器、振荡器、合成器、衰减器、滤波器、隔离器、环行器、移相器、调制解调器；光电子元件和组件：红外发射管、红外接收管、光电开关、光敏管、发光二极管和发光二极管组件、半导体激光二极管和激光器组件、光电探测器和光接收组件、光发射接收模块、光纤激光器和光放大器、光调制器、光开关、DWDM 用光发射和接收器件、用户接入系统光收发器件与模块、光纤连接器、光纤跳线/尾纤、光衰减器、光纤适配器、光隔离器、光耦合器、光环行器、光复用器/转换器；无线收发芯片和模组、蓝牙芯片和模组。

更多产品请看本公司产品专用销售网站：

商斯达中国传感器科技信息网：<http://www.sensor-ic.com/>

商斯达工控安防网：<http://www.pc-ps.net/>

商斯达电子元器件网：<http://www.sunstare.com/>

商斯达微波光电产品网：[HTTP://www.rfoe.net/](http://www.rfoe.net/)

商斯达消费电子产品网：<http://www.icasic.com/>

商斯达实业科技产品网：<http://www.sunstars.cn/> 微波元器件销售热线：

地址：深圳市福田区福华路福庆街鸿图大厦 1602 室

电话：0755-82884100 83397033 83396822 83398585

传真：0755-83376182 (0) 13823648918 MSN: SUNS8888@hotmail.com

邮编：518033 E-mail:[szss20@163.com](mailto:szss20@163.com) QQ: 195847376

深圳赛格展销部：深圳华强北路赛格电子市场 2583 号 电话：0755-83665529 25059422

技术支持：0755-83394033 13501568376

欢迎索取免费详细资料、设计指南和光盘；产品凡多，未能尽录，欢迎来电查询。

北京分公司：北京海淀区知春路 132 号中发电子大厦 3097 号

TEL: 010-81159046 82615020 13501189838 FAX: 010-62543996

上海分公司：上海市北京东路 668 号上海赛格电子市场 D125 号

TEL: 021-28311762 56703037 13701955389 FAX: 021-56703037

西安分公司：西安高新开发区 20 所(中国电子科技集团导航技术研究所)

西安劳动南路 88 号电子商城二楼 D23 号

TEL: 029-81022619 13072977981 FAX:029-88789382