

# DATA SHEET

## **BLF545** UHF push-pull power MOS transistor

Product specification

October 1992

# UHF push-pull power MOS transistor

# BLF545

## FEATURES

- High power gain
- Easy power control
- Good thermal stability
- Gold metallization ensures excellent reliability
- Designed for broadband operation.

## DESCRIPTION

Silicon N-channel enhancement mode vertical D-MOS push-pull transistor designed for communications transmitter applications in the UHF frequency range.

The transistor is encapsulated in a 4-lead, SOT268 balanced flange envelope, with two ceramic caps. The mounting flange provides the common source connection for the transistors.

## PIN CONFIGURATION

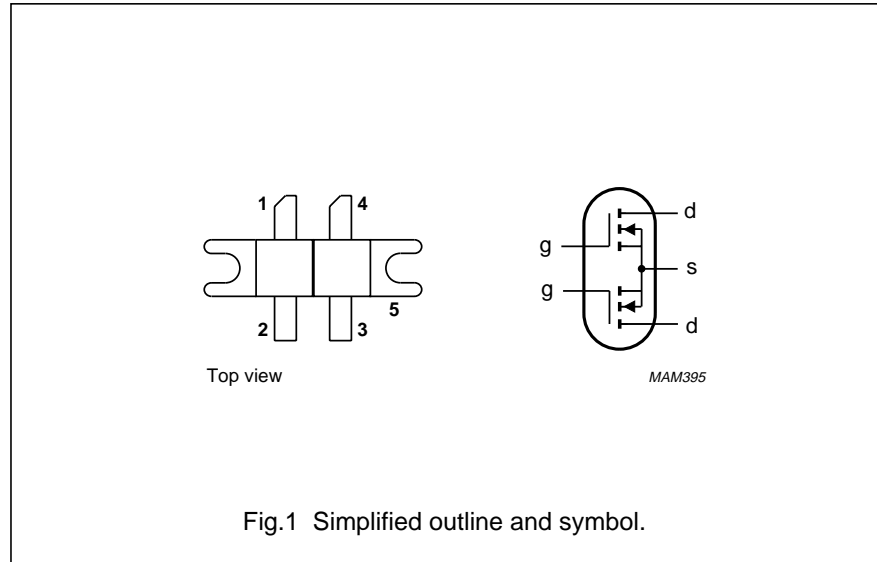

## CAUTION

The device is supplied in an antistatic package. The gate-source input must be protected against static charge during transport and handling.

## PINNING - SOT268

PIN	DESCRIPTION
1	drain 1
2	gate 1
3	gate 2
4	drain 2
5	source

## WARNING

**Product and environmental safety - toxic materials**

This product contains beryllium oxide. The product is entirely safe provided that the BeO discs are not damaged. All persons who handle, use or dispose of this product should be aware of its nature and of the necessary safety precautions. After use, dispose of as chemical or special waste according to the regulations applying at the location of the user. It must never be thrown out with the general or domestic waste.

## QUICK REFERENCE DATA

RF performance at  $T_h = 25\text{ }^\circ\text{C}$  in a push-pull common source circuit.

MODE OF OPERATION	f (MHz)	$V_{DS}$ (V)	$P_L$ (W)	$G_p$ (dB)	$\eta_D$ (%)
CW, class-B	500	28	40	> 11	> 50

# UHF push-pull power MOS transistor

BLF545

## LIMITING VALUES

In accordance with the Absolute Maximum System (IEC 134).

Per transistor section unless otherwise specified.

SYMBOL	PARAMETER	CONDITIONS	MIN.	MAX.	UNIT
$V_{DS}$	drain-source voltage		–	65	V
$\pm V_{GS}$	gate-source voltage		–	20	V
$I_D$	DC drain current		–	3.5	A
$P_{tot}$	total power dissipation	up to $T_{mb} = 25\text{ }^\circ\text{C}$ ; total device; both sections equally loaded	–	92	W
$T_{stg}$	storage temperature		–65	150	$^\circ\text{C}$
$T_j$	junction temperature		–	200	$^\circ\text{C}$

## THERMAL RESISTANCE

SYMBOL	PARAMETER	CONDITIONS	THERMAL RESISTANCE
$R_{th\ j-mb}$	thermal resistance from junction to mounting base	total device; both sections equally loaded	1.9 K/W
$R_{th\ mb-h}$	thermal resistance from mounting base to heatsink	total device; both sections equally loaded	0.25 K/W

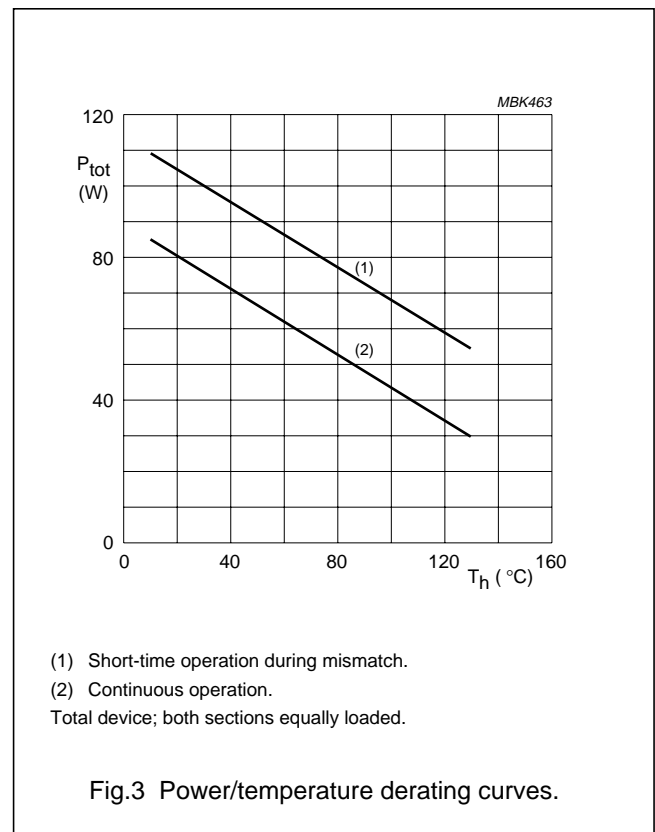
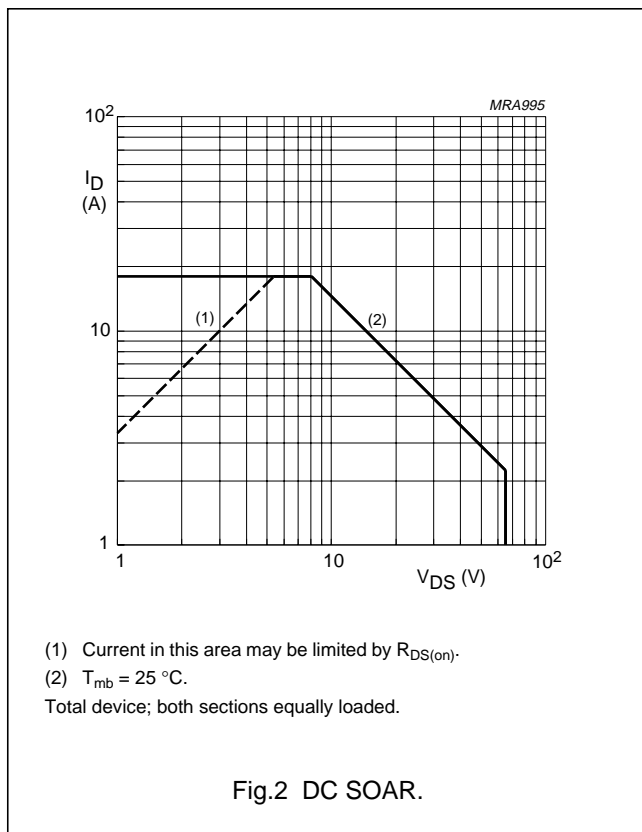

UHF push-pull power MOS transistor

BLF545

**CHARACTERISTICS (per section)**

$T_j = 25\text{ }^\circ\text{C}$  unless otherwise specified.

SYMBOL	PARAMETER	CONDITIONS	MIN.	TYP.	MAX.	UNIT
$V_{(BR)DSS}$	drain-source breakdown voltage	$V_{GS} = 0; I_D = 10\text{ mA}$	65	–	–	V
$I_{DSS}$	drain-source leakage current	$V_{GS} = 0; V_{DS} = 28\text{ V}$	–	–	1	mA
$I_{GSS}$	gate-source leakage current	$\pm V_{GS} = 20\text{ V}; V_{DS} = 0$	–	–	1	$\mu\text{A}$
$V_{GS(th)}$	gate-source threshold voltage	$I_D = 40\text{ mA}; V_{DS} = 10\text{ V}$	1	–	4	V
$g_{fs}$	forward transconductance	$I_D = 1.2\text{ A}; V_{DS} = 10\text{ V}$	600	900	–	mS
$R_{DS(on)}$	drain-source on-state resistance	$I_D = 1.2\text{ A}; V_{GS} = 10\text{ V}$	–	0.85	1.25	$\Omega$
$I_{DSX}$	on-state drain current	$V_{GS} = 15\text{ V}; V_{DS} = 10\text{ V}$	–	4.8	–	A
$C_{is}$	input capacitance	$V_{GS} = 0; V_{DS} = 28\text{ V}; f = 1\text{ MHz}$	–	32	–	pF
$C_{os}$	output capacitance	$V_{GS} = 0; V_{DS} = 28\text{ V}; f = 1\text{ MHz}$	–	24	–	pF
$C_{rs}$	feedback capacitance	$V_{GS} = 0; V_{DS} = 28\text{ V}; f = 1\text{ MHz}$	–	6.4	–	pF

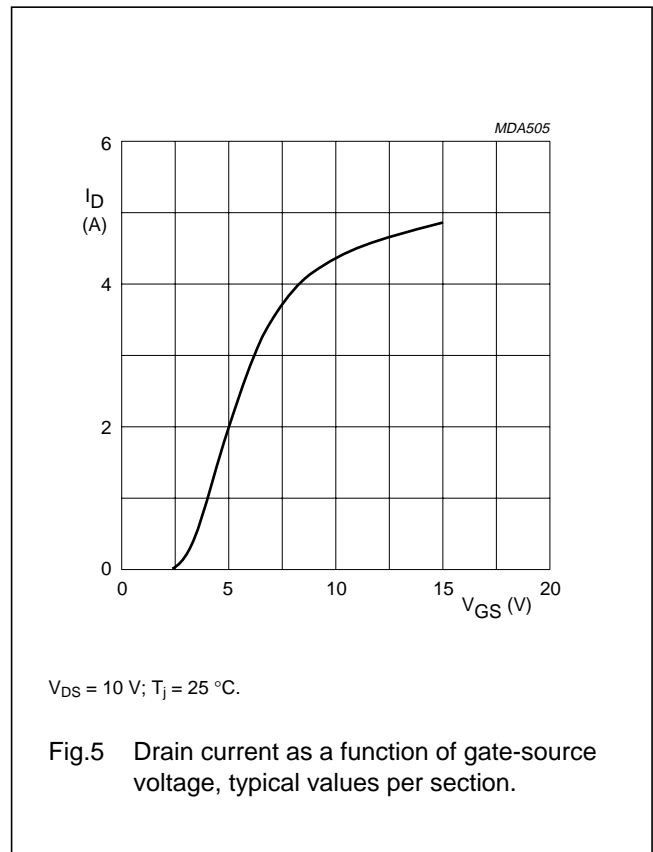
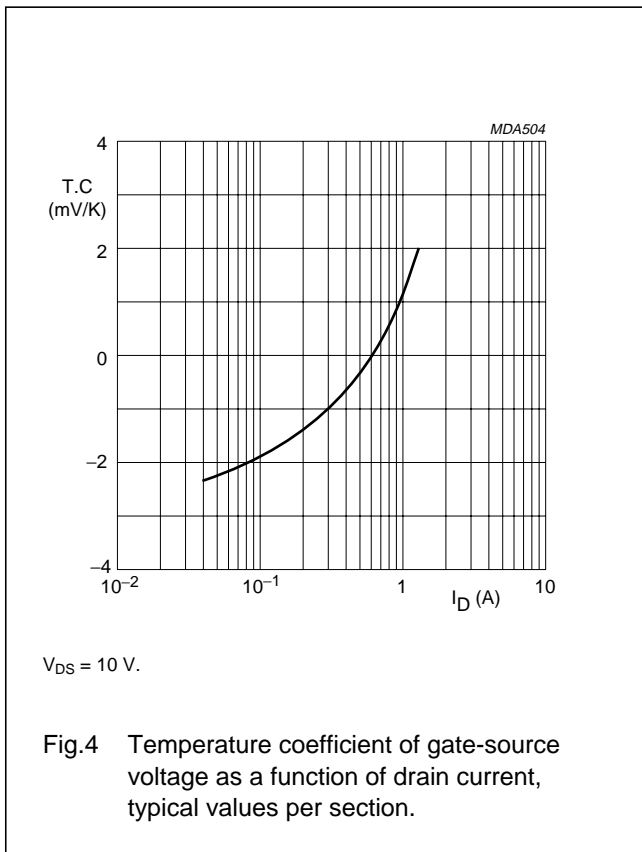

UHF push-pull power MOS transistor

BLF545

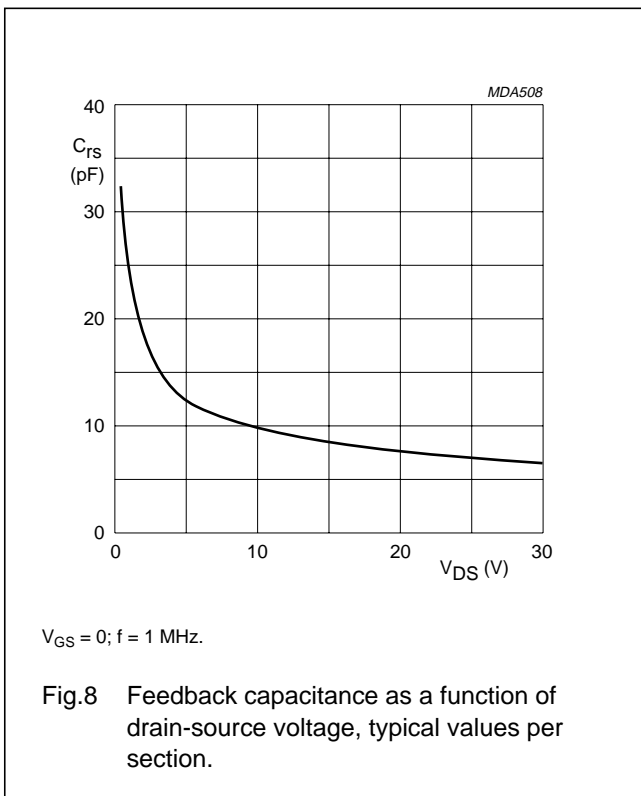
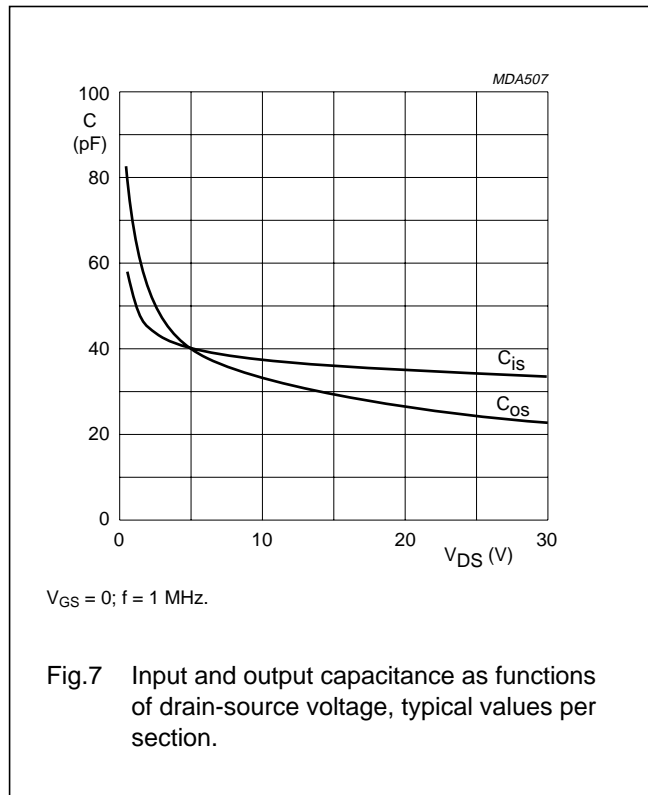
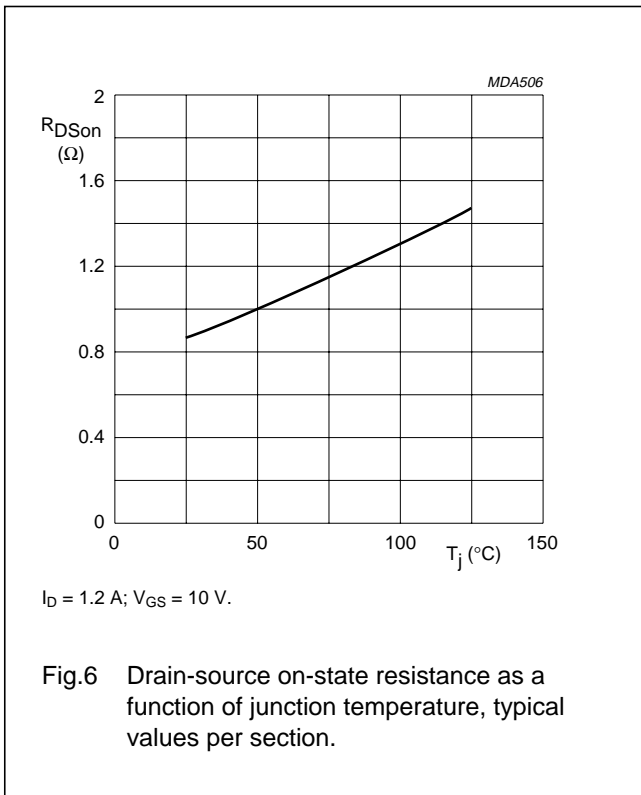

# UHF push-pull power MOS transistor

BLF545

## APPLICATION INFORMATION FOR CLASS-B OPERATION

$T_h = 25\text{ }^\circ\text{C}$ ;  $R_{th\ mb-h} = 0.25\text{ K/W}$ , unless otherwise specified.

RF performance in a common source, class-B, push-pull circuit.

MODE OF OPERATION	f (MHz)	V <sub>DS</sub> (V)	I <sub>DQ</sub> (mA)	P <sub>L</sub> (W)	G <sub>p</sub> (dB)	η <sub>D</sub> (%)
CW, class-B	500	28	2 × 40	40	> 11 typ. 13	> 50 typ. 60

### Ruggedness in class-B operation

The BLF545 is capable of withstanding a full load mismatch corresponding to VSWR = 50 through all phases under the following conditions:

V<sub>DS</sub> = 28 V; f = 500 MHz at rated output power.

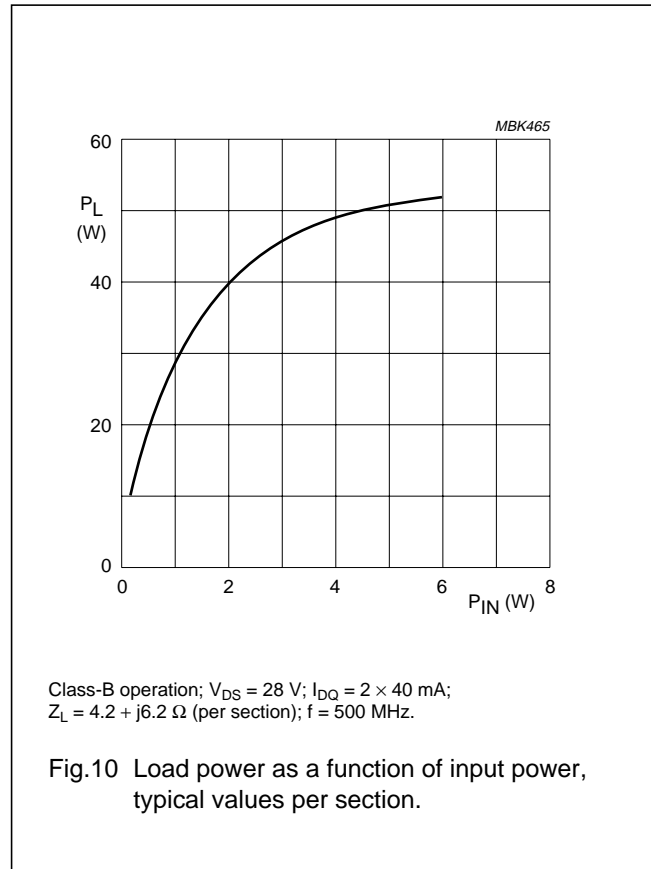
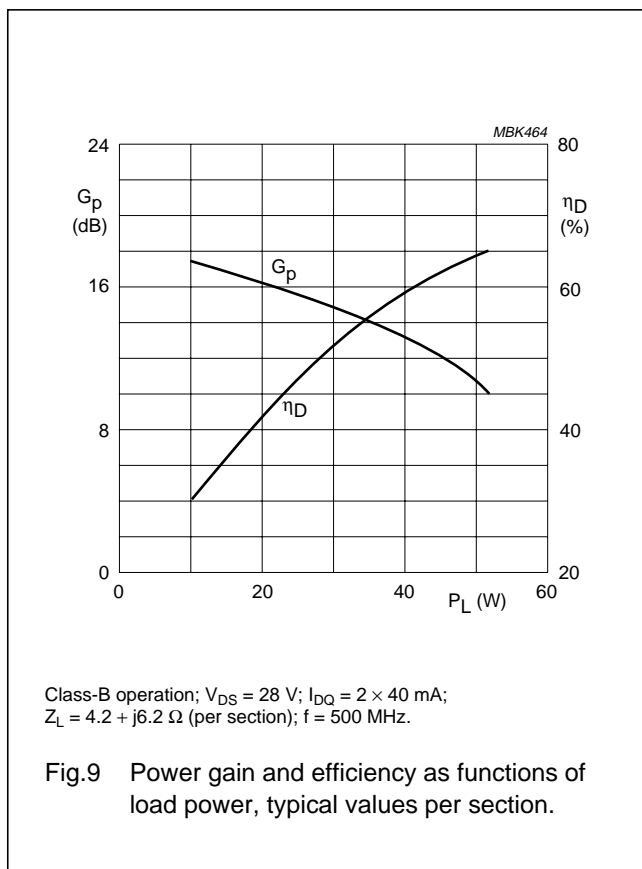

UHF push-pull power MOS transistor

BLF545

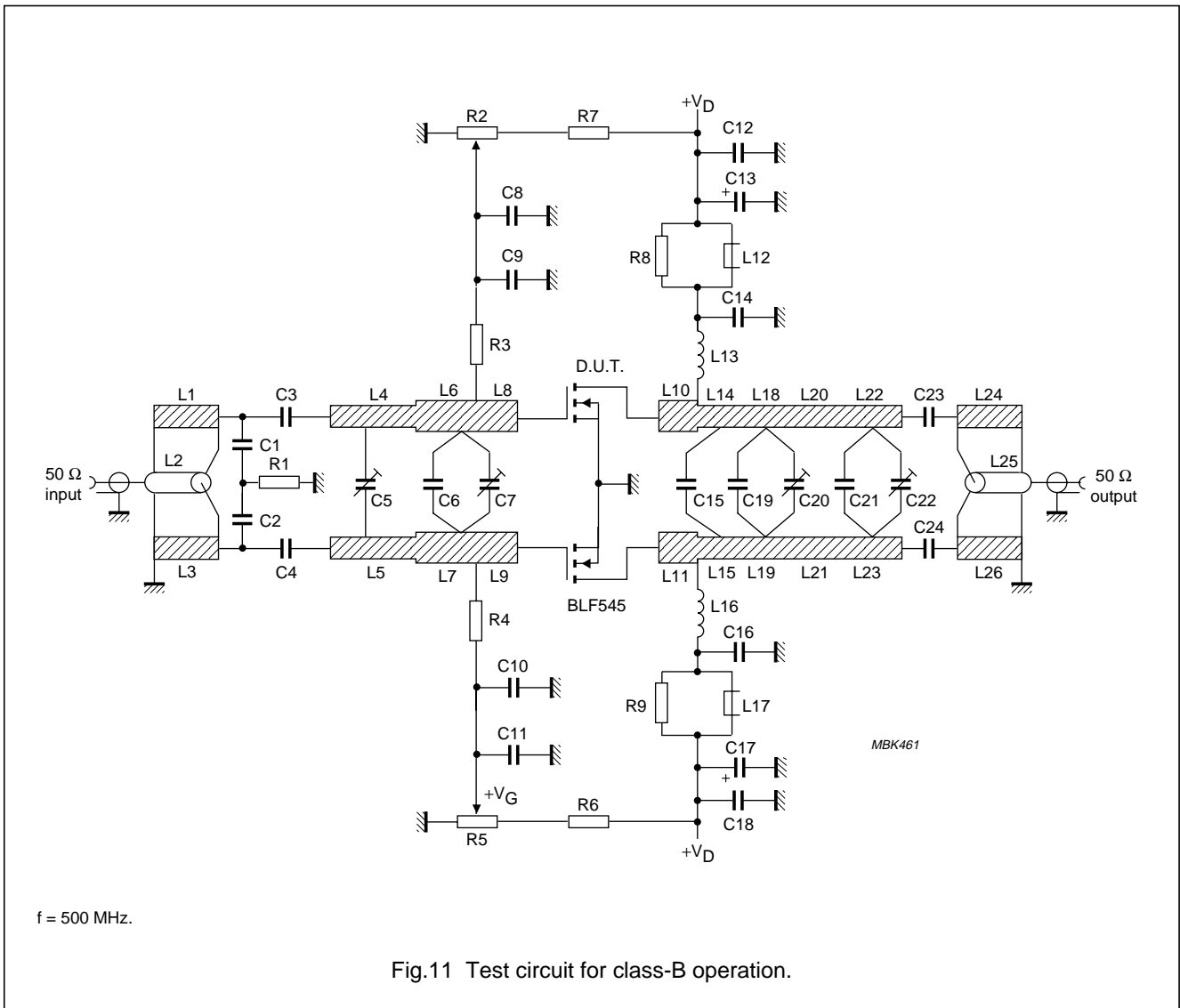

f = 500 MHz.

Fig.11 Test circuit for class-B operation.

## UHF push-pull power MOS transistor

BLF545

## List of components (class-B test circuit)

COMPONENT	DESCRIPTION	VALUE	DIMENSIONS	CATALOGUE NO.
C1, C2	multilayer ceramic chip capacitor (note 1)	5.1 pF		
C3, C4	multilayer ceramic chip capacitor (note 1)	16 pF		
C5, C7, C20, C22	film dielectric trimmer	1.8 to 10 pF		2222 809 05002
C6	multilayer ceramic chip capacitor (note 1)	22 pF		
C8, C11, C12, C18	multilayer ceramic chip capacitor	100 nF		2222 852 47104
C9, C10, C14, C16	multilayer ceramic chip capacitor (note 1)	390 pF		
C13, C17	electrolytic capacitor	10 $\mu$ F, 63 V		
C15	multilayer ceramic chip capacitor (note 1)	18 pF		
C19	multilayer ceramic chip capacitor (note 1)	13 pF		
C21	multilayer ceramic chip capacitor (note 1)	6.2 pF		
C23, C24	multilayer ceramic chip capacitor (note 1)	10 pF		
L1, L3, L24, L26	stripline (note 2)	50 $\Omega$	56 $\times$ 2.4 mm	
L2, L25	semi-rigid cable (note 3)	50 $\Omega$	ext. dia. 2.2 mm ext. conductor length 56 mm	
L4, L5	stripline (note 2)	56 $\Omega$	13.4 $\times$ 2 mm	
L6, L7	stripline (notes 2 and 4)	56 $\Omega$	9.6 $\times$ 2 mm	
L8, L9	stripline (note 2)	42 $\Omega$	9 $\times$ 3 mm	
L10, L11	stripline (note 2)	42 $\Omega$	6 $\times$ 3 mm	
L12, L17	grade 3B Ferroxcube RF choke			4312 020 36642
L13, L16	4 turns enamelled 1.2 mm copper wire	62 nH	length 7.6 mm int. dia. 5 mm leads 2 $\times$ 5 mm	
L14, L15	stripline (note 2)	56 $\Omega$	8 $\times$ 2 mm	
L18, L19	stripline (note 2)	56 $\Omega$	13 $\times$ 2 mm	
L20, L21	stripline (note 2)	56 $\Omega$	18 $\times$ 2 mm	
L22, L23	stripline (note 2)	56 $\Omega$	14 $\times$ 2 mm	
R1	0.4 W metal film resistor	5.11 $\Omega$		2322 151 75118
R2, R5	10 turns cermet potentiometer	50 k $\Omega$		
R3, R4	0.4 W metal film resistor	10 k $\Omega$		2322 151 71003
R6, R7	0.4 W metal film resistor	205 k $\Omega$		2322 151 72054
R8, R9	1 W metal film resistor	10 $\Omega$		2322 151 71009

## Notes

1. American Technical Ceramics (ATC) capacitor, type 100B or other capacitor of the same quality.



UHF push-pull power MOS transistor

BLF545

2. The striplines are on a double copper-clad printed circuit board, with glass microfibre reinforced PTFE ( $\epsilon_r = 2.2$ ); thickness  $\frac{1}{32}$  inch.
3. Semi-rigid cables L2 and L25 are soldered on to striplines L1 and L26.
4. Striplines L6 and L7 are used in series with a  $42 \Omega$  stripline ( $11 \times 3$  mm).

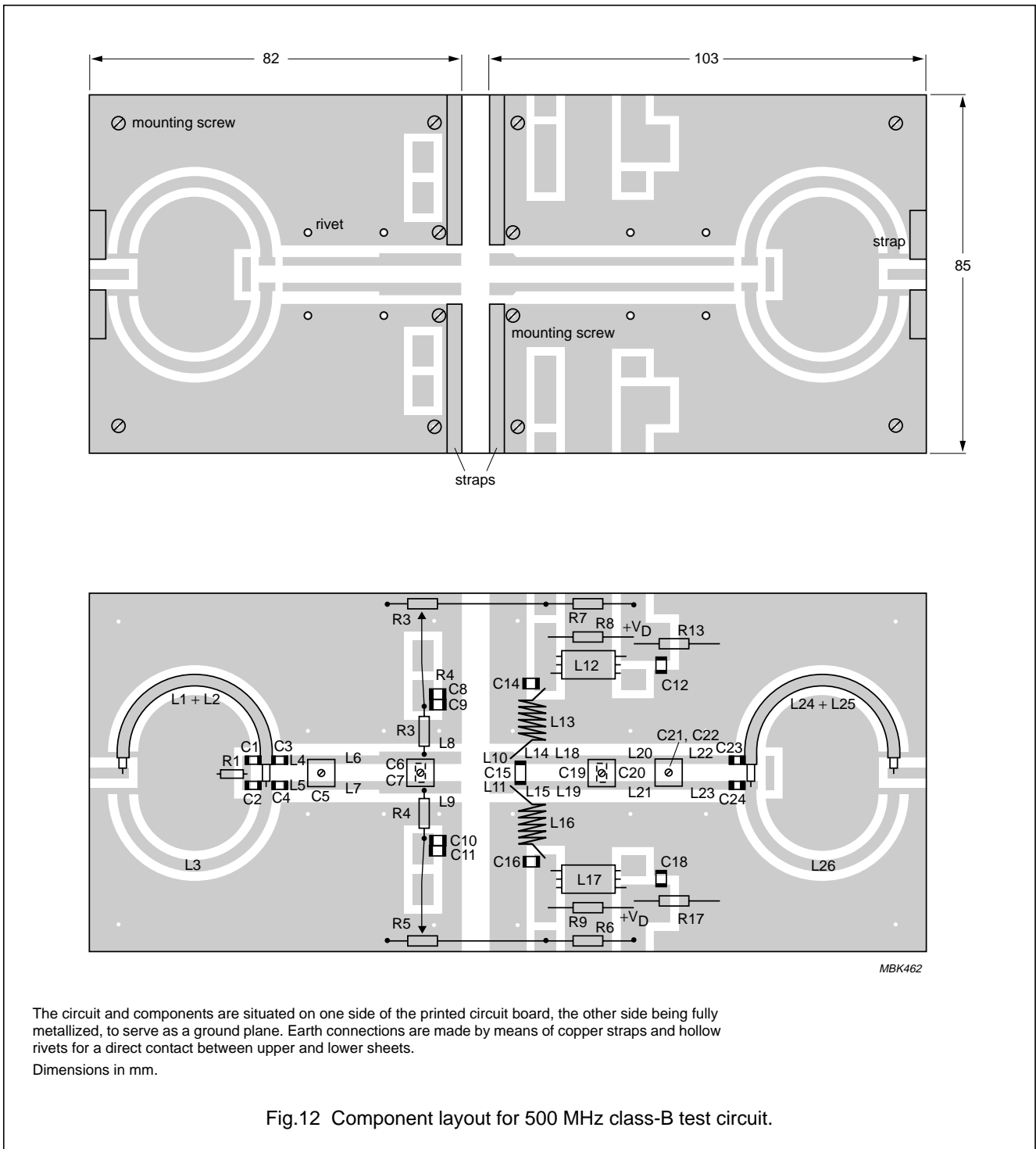

UHF push-pull power MOS transistor

BLF545

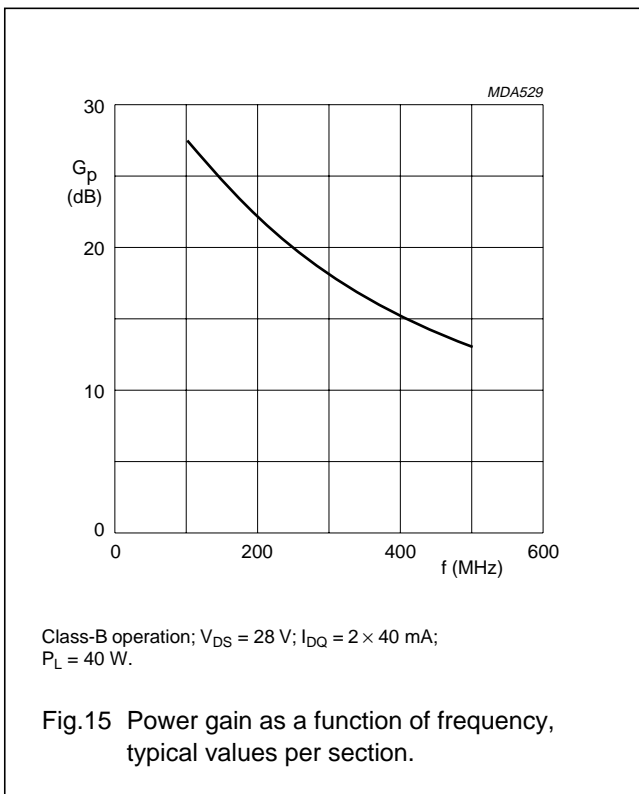
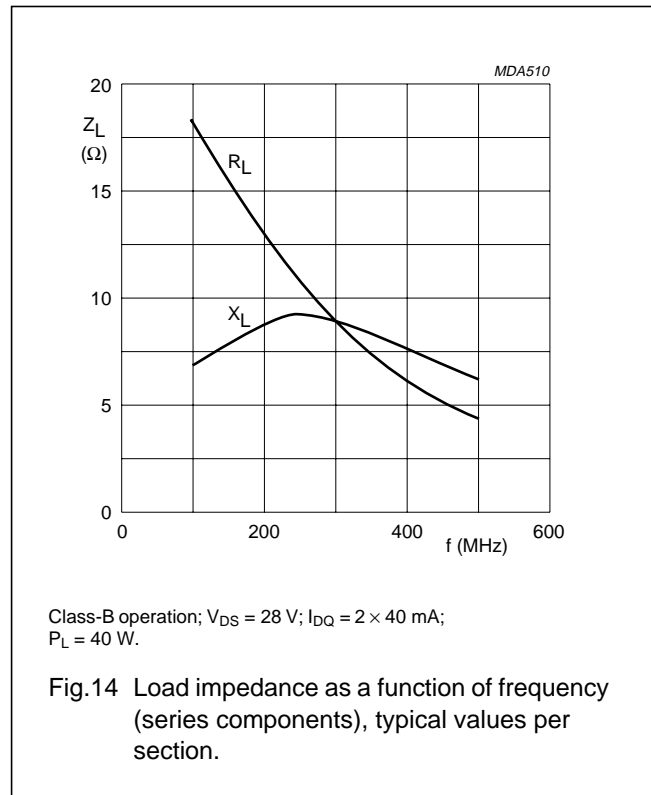
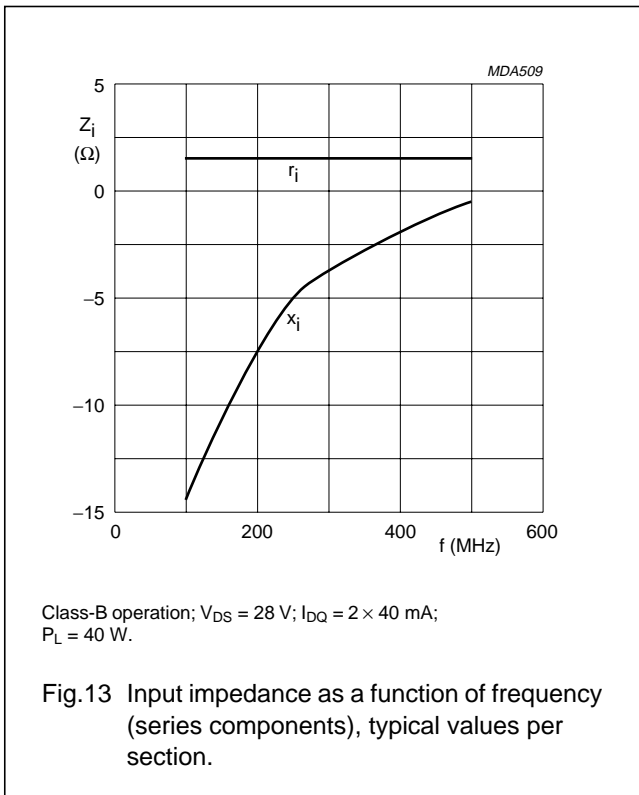

# UHF push-pull power MOS transistor

BLF545

## PACKAGE OUTLINE

Flanged double-ended ceramic package; 2 mounting holes; 4 leads

SOT268A

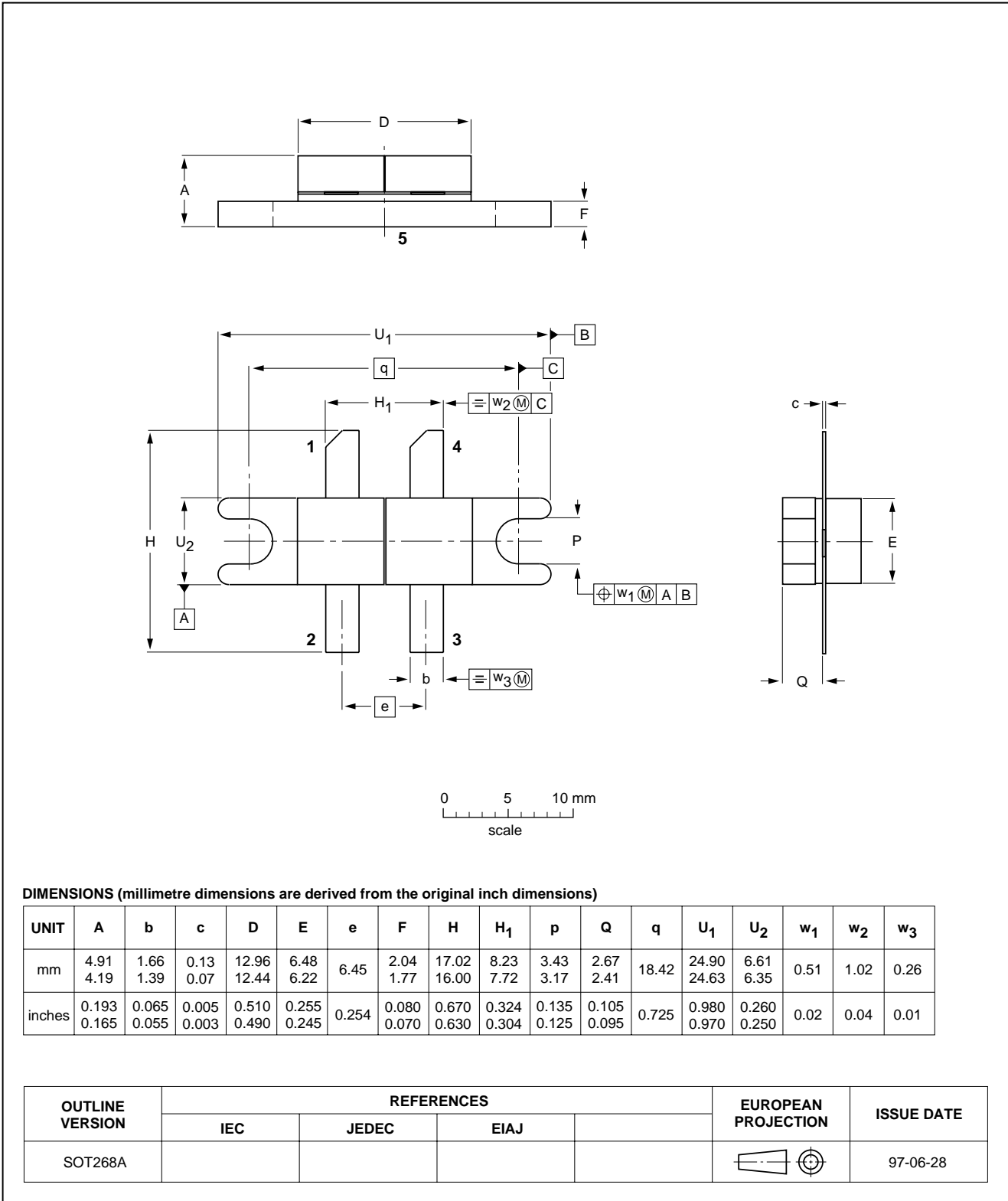

## UHF push-pull power MOS transistor

BLF545

**DEFINITIONS**

<b>Data Sheet Status</b>	
Objective specification	This data sheet contains target or goal specifications for product development.
Preliminary specification	This data sheet contains preliminary data; supplementary data may be published later.
Product specification	This data sheet contains final product specifications.
<b>Limiting values</b>	
Limiting values given are in accordance with the Absolute Maximum Rating System (IEC 134). Stress above one or more of the limiting values may cause permanent damage to the device. These are stress ratings only and operation of the device at these or at any other conditions above those given in the Characteristics sections of the specification is not implied. Exposure to limiting values for extended periods may affect device reliability.	
<b>Application information</b>	
Where application information is given, it is advisory and does not form part of the specification.	

**LIFE SUPPORT APPLICATIONS**

These products are not designed for use in life support appliances, devices, or systems where malfunction of these products can reasonably be expected to result in personal injury. Philips customers using or selling these products for use in such applications do so at their own risk and agree to fully indemnify Philips for any damages resulting from such improper use or sale.

SUNSTAR 商斯达实业集团是集研发、生产、工程、销售、代理经销、技术咨询、信息服务等为一体的高科技企业，是专业高科技电子产品生产厂家，是具有 10 多年历史的专业电子元器件供应商，是中国最早和最大的仓储式连锁规模经营大型综合电子零部件代理分销商之一，是一家专业代理和分销世界各大品牌 IC 芯片和电子元器件的连锁经营综合性国际公司，专业经营进口、国产名厂名牌电子元件，型号、种类齐全。在香港、北京、深圳、上海、西安、成都等全国主要电子市场设有直属分公司和产品展示展销窗口门市部专卖店及代理分销商，已在全国范围内建成强大统一的供货和代理分销网络。我们专业代理经销、开发生产电子元器件、集成电路、传感器、微波光电元器件、工控机/DOC/DOM 电子盘、专用电路、单片机开发、MCU/DSP/ARM/FPGA 软件硬件、二极管、三极管、模块等，是您可靠的一站式现货配套供应商、方案提供商、部件功能模块开发配套商。商斯达实业公司拥有庞大的资料库，有数位毕业于著名高校——有中国电子工业摇篮之称的西安电子科技大学（西军电）并长期从事国防尖端科技研究的高级工程师为您精挑细选、量身订做各种高科技电子元器件，并解决各种技术问题。

微波光电部专业代理经销高频、微波、光纤、光电元器件、组件、部件、模块、整机；电磁兼容元器件、材料、设备；微波 CAD、EDA 软件、开发测试仿真工具；微波、光纤仪器仪表。欢迎国外高科技微波、光纤厂商将优秀产品介绍到中国、共同开拓市场。长期大量现货专业批发高频、微波、卫星、光纤、电视、CATV 器件：晶振、VCO、连接器、PIN 开关、变容二极管、开关二极管、低噪晶体管、功率电阻及电容、放大器、功率管、MMIC、混频器、耦合器、功分器、振荡器、合成器、衰减器、滤波器、隔离器、环行器、移相器、调制解调器；光电子元件和组件：红外发射管、红外接收管、光电开关、光敏管、发光二极管和发光二极管组件、半导体激光二极管和激光器组件、光电探测器和光接收组件、光发射接收模块、光纤激光器和光放大器、光调制器、光开关、DWDM 用光发射和接收器件、用户接入系统光收发器件与模块、光纤连接器、光纤跳线/尾纤、光衰减器、光纤适配器、光隔离器、光耦合器、光环行器、光复用器/转换器；无线收发芯片和模组、蓝牙芯片和模组。

更多产品请看本公司产品专用销售网站：

商斯达中国传感器科技信息网：<http://www.sensor-ic.com/>

商斯达工控安防网：<http://www.pc-ps.net/>

商斯达电子元器件网：<http://www.sunstare.com/>

商斯达微波光电产品网：[HTTP://www.rfoe.net/](http://www.rfoe.net/)

商斯达消费电子产品网：<http://www.icasic.com/>

商斯达实业科技产品网：<http://www.sunstars.cn/> 微波元器件销售热线：

地址：深圳市福田区福华路福庆街鸿图大厦 1602 室

电话：0755-82884100 83397033 83396822 83398585

传真：0755-83376182 (0) 13823648918 MSN: SUNS8888@hotmail.com

邮编：518033 E-mail:[szss20@163.com](mailto:szss20@163.com) QQ: 195847376

深圳赛格展销部：深圳华强北路赛格电子市场 2583 号 电话：0755-83665529 25059422

技术支持：0755-83394033 13501568376

欢迎索取免费详细资料、设计指南和光盘；产品凡多，未能尽录，欢迎来电查询。

北京分公司：北京海淀区知春路 132 号中发电子大厦 3097 号

TEL: 010-81159046 82615020 13501189838 FAX: 010-62543996

上海分公司：上海市北京东路 668 号上海赛格电子市场 D125 号

TEL: 021-28311762 56703037 13701955389 FAX: 021-56703037

西安分公司：西安高新开发区 20 所(中国电子科技集团导航技术研究所)

西安劳动南路 88 号电子商城二楼 D23 号

TEL: 029-81022619 13072977981 FAX:029-88789382