

DATA SHEET

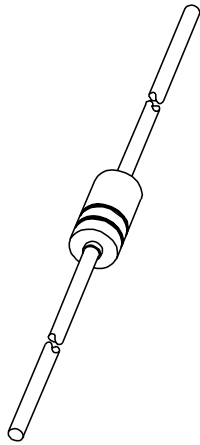

KTY84-1 series **Silicon temperature sensors**

Product specification
Supersedes data of 1996 Dec 06
File under Discrete Semiconductors, SC17

1998 Apr 09

Silicon temperature sensors

KTY84-1 series

DESCRIPTION

The temperature sensors in the KTY84-1 series have a positive temperature coefficient of resistance and are suitable for use in measurement and control systems over a temperature range of -40 to +300 °C. The sensors are encapsulated in the SOD68 (DO-34) leaded package.

Tolerances of 0.5% or other special selections are available on request.

MARKING

TYPE NUMBER	MARKING BAND COLOUR
KTY84-130	yellow
KTY84-150	grey
KTY84-151	black
KTY84-152	blue

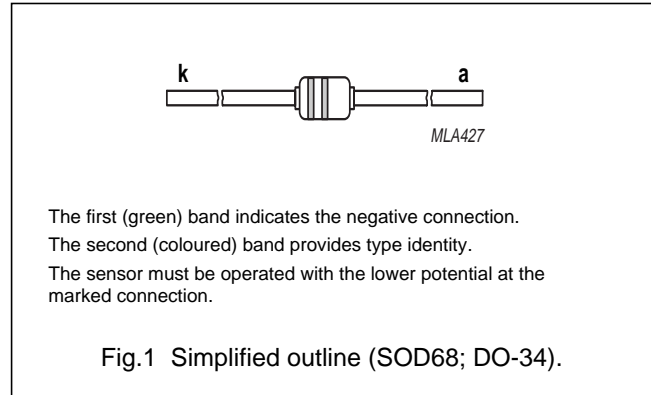

QUICK REFERENCE DATA

SYMBOL	PARAMETER	CONDITIONS	MIN.	MAX.	UNIT
R ₁₀₀	sensor resistance	T _{amb} = 100 °C; I _{cont} = 2 mA			
	KTY84-130		970	1030	Ω
	KTY84-150		950	1050	Ω
	KTY84-151		950	1000	Ω
	KTY84-152		1000	1050	Ω
T _{amb}	ambient operating temperature		-40	+300	°C

LIMITING VALUES

In accordance with the Absolute Maximum Rating System (IEC 134).

SYMBOL	PARAMETER	CONDITIONS	MIN.	MAX.	UNIT
I _{cont}	continuous sensor current	in free air; T _{amb} = 25 °C; note 1	-	10	mA
		in free air; T _{amb} = 300 °C	-	2	mA
T _{amb}	ambient operating temperature		-40	+300	°C
T _{stg}	storage temperature		-55	+300	°C

Note

- For temperatures greater than 200 °C, a sensor current of I_{cont} = 2 mA must be used.

Silicon temperature sensors

KTY84-1 series

CHARACTERISTICS

$T_{amb} = 100\text{ }^{\circ}\text{C}$, in liquid, unless otherwise specified.

SYMBOL	PARAMETER	CONDITIONS	MIN.	TYP.	MAX.	UNIT
R_{100}	sensor resistance	$I_{cont} = 2\text{ mA}$				
	KTY84-130		970	–	1030	Ω
	KTY84-150		950	–	1050	Ω
	KTY84-151		950	–	1000	Ω
	KTY84-152	1000	–	1050	Ω	
TC	temperature coefficient		–	0.61	–	%/K
R_{250}/R_{100}	resistance ratio	$T_{amb} = 250\text{ }^{\circ}\text{C}$ and $100\text{ }^{\circ}\text{C}$	2.111	2.166	2.221	
R_{25}/R_{100}	resistance ratio	$T_{amb} = 25\text{ }^{\circ}\text{C}$ and $100\text{ }^{\circ}\text{C}$	0.595	0.603	0.611	
τ	thermal time constant; note 1	in still air	–	20	–	s
		in still liquid; note 2	–	1	–	s
		in flowing liquid; note 2	–	0.5	–	s
	rated temperature range		–40	–	+300	$^{\circ}\text{C}$

Notes

- The thermal time constant is the time taken for the sensor to reach 63.2% of the total temperature difference. For example, if a sensor with a temperature of $25\text{ }^{\circ}\text{C}$ is moved to an environment with an ambient temperature of $100\text{ }^{\circ}\text{C}$, the time for the sensor to reach a temperature of $72.4\text{ }^{\circ}\text{C}$ is the thermal time constant.
- Inert liquid, e.g. FC43 manufactured by the 3M company.

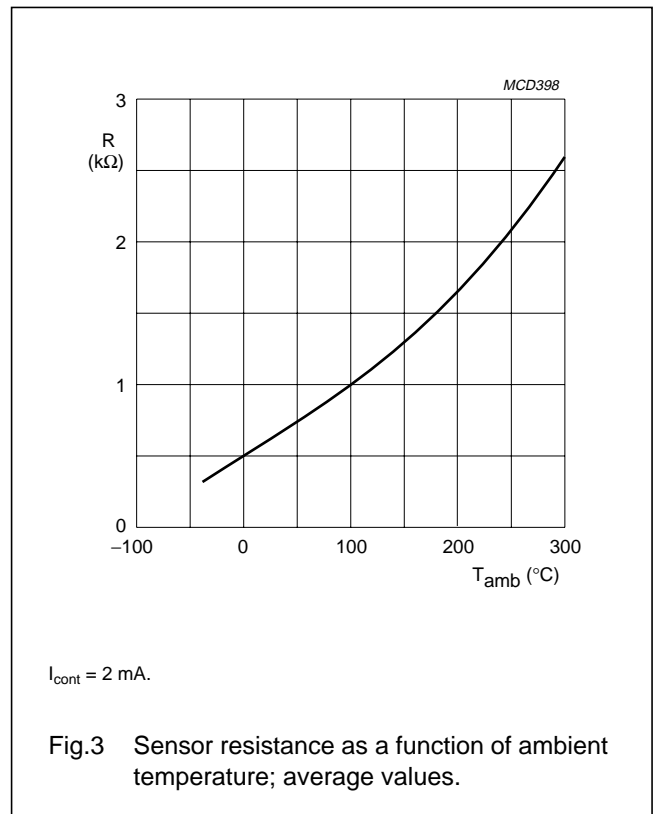
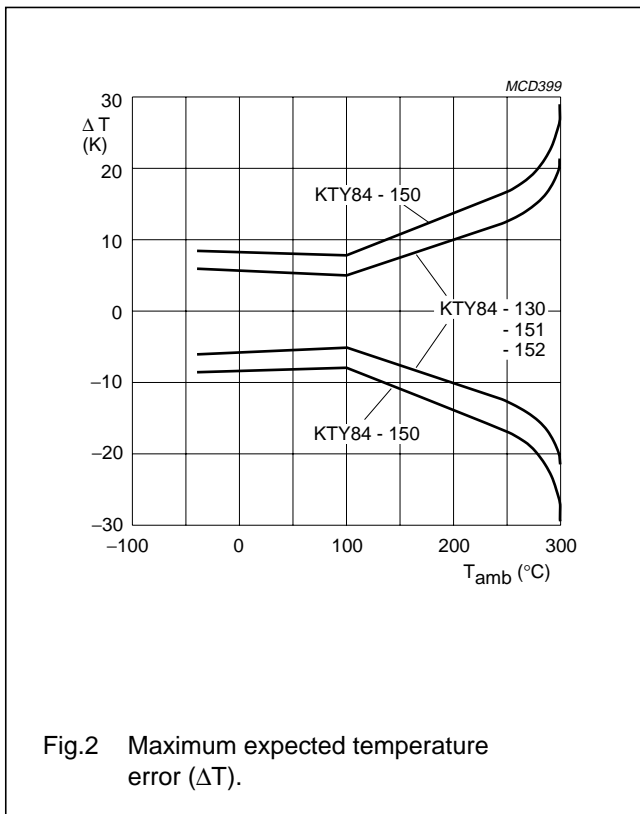

Silicon temperature sensors

KTY84-1 series

Table 1 Ambient temperature, corresponding resistance, temperature coefficient and maximum expected temperature error for KTY84-130 and KTY84-150 $I_{\text{cont}} = 2 \text{ mA}$.

AMBIENT TEMPERATURE		TEMP. COEFF. (%/K)	KTY84-130				KTY84-150				
(°C)	(°F)		RESISTANCE (Ω)			TEMP. ERROR (K)	RESISTANCE (Ω)			TEMP. ERROR (K)	
			MIN.	TYP.	MAX.		MIN.	TYP.	MAX.		
-40	-40	0.84	340	359	379	±6.48	332	359	386	±8.85	
-30	-22	0.83	370	391	411	±6.36	362	391	419	±8.76	
-20	-4	0.82	403	424	446	±6.26	394	424	455	±8.7	
-10	14	0.80	437	460	483	±6.16	428	460	492	±8.65	
0	32	0.79	474	498	522	±6.07	464	498	532	±8.61	
10	50	0.77	514	538	563	±5.98	503	538	574	±8.58	
20	68	0.75	555	581	607	±5.89	544	581	618	±8.55	
25	77	0.74	577	603	629	±5.84	565	603	641	±8.54	
30	86	0.73	599	626	652	±5.79	587	626	665	±8.53	
40	104	0.71	645	672	700	±5.69	632	672	713	±8.5	
50	122	0.70	694	722	750	±5.59	679	722	764	±8.46	
60	140	0.68	744	773	801	±5.47	729	773	817	±8.42	
70	158	0.66	797	826	855	±5.34	781	826	872	±8.37	
80	176	0.64	852	882	912	±5.21	835	882	929	±8.31	
90	194	0.63	910	940	970	±5.06	891	940	989	±8.25	
100	212	0.61	970	1000	1030	±4.9	950	1000	1050	±8.17	
110	230	0.60	1029	1062	1096	±5.31	1007	1062	1117	±8.66	
120	248	0.58	1089	1127	1164	±5.73	1067	1127	1187	±9.17	
130	266	0.57	1152	1194	1235	±6.17	1128	1194	1259	±9.69	
140	284	0.55	1216	1262	1309	±6.63	1191	1262	1334	±10.24	
150	302	0.54	1282	1334	1385	±7.1	1256	1334	1412	±10.8	
160	320	0.53	1350	1407	1463	±7.59	1322	1407	1492	±11.37	
170	338	0.52	1420	1482	1544	±8.1	1391	1482	1574	±11.96	
180	356	0.51	1492	1560	1628	±8.62	1461	1560	1659	±12.58	
190	374	0.49	1566	1640	1714	±9.15	1533	1640	1747	±13.2	
200	392	0.48	1641	1722	1803	±9.71	1607	1722	1837	±13.85	
210	410	0.47	1719	1807	1894	±10.28	1683	1807	1931	±14.51	
220	428	0.46	1798	1893	1988	±10.87	1760	1893	2026	±15.19	
230	446	0.45	1879	1982	2085	±11.47	1839	1982	2125	±15.88	
240	464	0.44	1962	2073	2184	±12.09	1920	2073	2226	±16.59	
250	482	0.44	2046	2166	2286	±12.73	2003	2166	2329	±17.32	
260	500	0.42	2132	2261	2390	±13.44	2087	2261	2436	±18.15	
270	518	0.41	2219	2357	2496	±14.44	2172	2357	2543	±19.36	
280	536	0.38	2304	2452	2600	±15.94	2255	2452	2650	±21.21	
290	554	0.34	2384	2542	2700	±18.26	2333	2542	2751	±24.14	
300	572	0.29	2456	2624	2791	±22.12	2404	2624	2844	±29.05	

Silicon temperature sensors

KTY84-1 series

Table 2 Ambient temperature, corresponding resistance, temperature coefficient and maximum expected temperature error for KTY84-151 and KTY84-152 $I_{\text{cont}} = 2 \text{ mA}$.

AMBIENT TEMPERATURE		TEMP. COEFF. (%/K)	KTY84-151				KTY84-152				
(°C)	(°F)		RESISTANCE (Ω)			TEMP. ERROR (K)	RESISTANCE (Ω)			TEMP. ERROR (K)	
			MIN.	TYP.	MAX.		MIN.	TYP.	MAX.		
-40	-40	0.84	332	350	368	±5.97	350	368	386	±5.82	
-30	-22	0.83	362	381	399	±5.84	381	400	419	±5.69	
-20	-4	0.82	394	414	433	±5.72	415	435	455	±5.57	
-10	14	0.80	428	449	469	±5.62	451	472	492	±5.46	
0	32	0.79	464	486	507	±5.51	489	511	532	±5.35	
10	50	0.77	503	525	547	±5.41	530	552	574	±5.25	
20	68	0.75	544	566	589	±5.31	573	595	618	±5.14	
25	77	0.74	565	588	611	±5.25	595	618	641	±5.08	
30	86	0.73	587	610	633	±5.2	618	641	665	±5.03	
40	104	0.71	632	656	679	±5.08	665	689	713	±4.91	
50	122	0.70	679	704	728	±4.96	715	740	764	±4.78	
60	140	0.68	729	754	778	±4.83	767	792	817	±4.64	
70	158	0.66	781	806	831	±4.68	822	847	872	±4.5	
80	176	0.64	835	860	885	±4.53	879	904	929	±4.34	
90	194	0.63	891	916	942	±4.37	938	963	989	±4.17	
100	212	0.61	950	975	1000	±4.19	1000	1025	1050	±3.99	
110	230	0.60	1007	1036	1064	±4.58	1060	1089	1117	±4.37	
120	248	0.58	1067	1099	1131	±4.99	1123	1155	1187	±4.77	
130	266	0.57	1128	1164	1199	±5.41	1187	1223	1259	±5.19	
140	284	0.55	1191	1231	1271	±5.84	1254	1294	1334	±5.62	
150	302	0.54	1256	1300	1345	±6.3	1322	1367	1412	±6.07	
160	320	0.53	1322	1372	1421	±6.77	1392	1442	1492	±6.53	
170	338	0.52	1391	1445	1500	±7.25	1464	1519	1574	±7.01	
180	356	0.51	1461	1521	1581	±7.75	1538	1599	1659	±7.51	
190	374	0.49	1533	1599	1664	±8.27	1614	1681	1747	±8.02	
200	392	0.48	1607	1679	1751	±8.81	1692	1765	1837	±8.55	
210	410	0.47	1683	1761	1839	±9.36	1772	1852	1931	±9.09	
220	428	0.46	1760	1846	1931	±9.93	1854	1940	2026	±9.66	
230	446	0.45	1839	1932	2024	±10.51	1937	2031	2125	±10.23	
240	464	0.44	1920	2021	2121	±11.11	2022	2125	2226	±10.83	
250	482	0.44	2003	2112	2220	±11.73	2110	2220	2329	±11.44	
260	500	0.42	2087	2205	2321	±12.42	2198	2318	2436	±12.12	
270	518	0.41	2172	2298	2424	±13.37	2288	2416	2543	±13.06	
280	536	0.38	2257	2391	2525	±14.79	2376	2513	2650	±14.46	
290	554	0.34	2335	2479	2622	±16.98	2459	2606	2751	±16.61	
300	572	0.29	2406	2558	2710	±20.61	2533	2689	2844	±20.18	

Silicon temperature sensors

KTY84-1 series

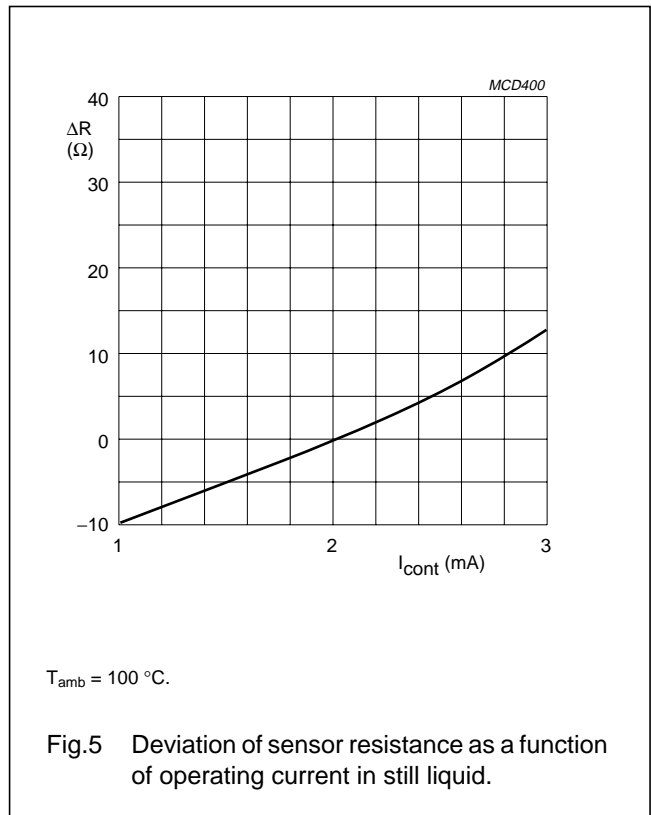
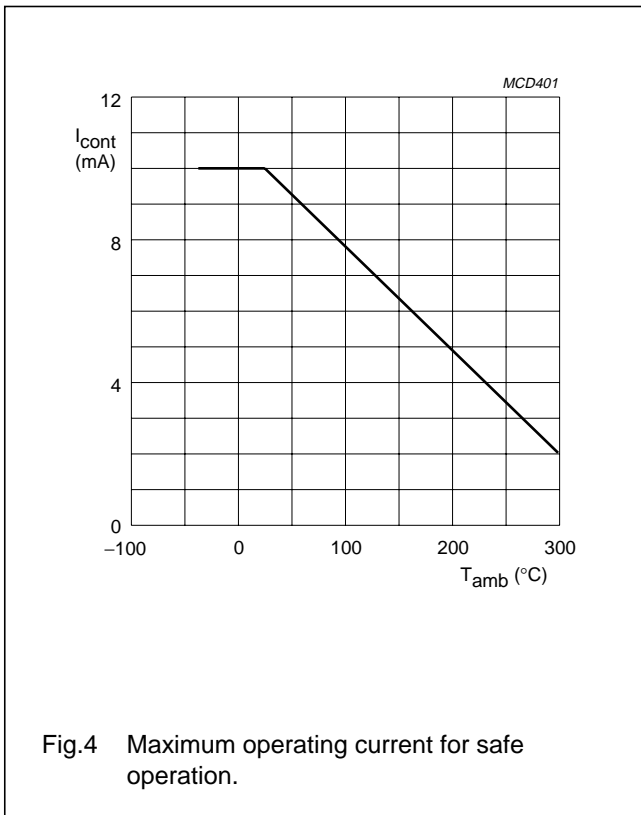

Silicon temperature sensors

KTY84-1 series

PACKAGE OUTLINE

Hermetically sealed glass package; axial leaded; 2 leads

SOD68

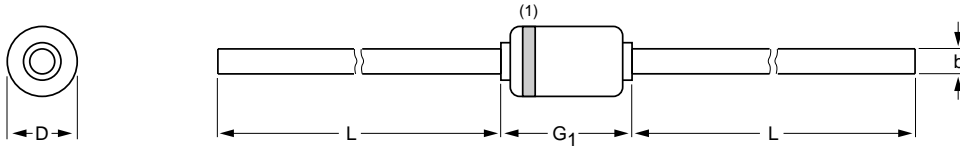

DIMENSIONS (mm are the original dimensions)

UNIT	b max.	D max.	G ₁ max.	L min.
mm	0.55	1.6	3.04	25.4

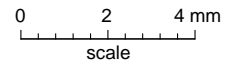

Note

1. The marking band indicates the cathode.

OUTLINE VERSION	REFERENCES				EUROPEAN PROJECTION	ISSUE DATE
	IEC	JEDEC	EIAJ			
SOD68		DO-34				97-06-09

Silicon temperature sensors

KTY84-1 series

DEFINITIONS

Data Sheet Status	
Objective specification	This data sheet contains target or goal specifications for product development.
Preliminary specification	This data sheet contains preliminary data; supplementary data may be published later.
Product specification	This data sheet contains final product specifications.
Limiting values	
Limiting values given are in accordance with the Absolute Maximum Rating System (IEC 134). Stress above one or more of the limiting values may cause permanent damage to the device. These are stress ratings only and operation of the device at these or at any other conditions above those given in the Characteristics sections of the specification is not implied. Exposure to limiting values for extended periods may affect device reliability.	
Application information	
Where application information is given, it is advisory and does not form part of the specification.	

LIFE SUPPORT APPLICATIONS

These products are not designed for use in life support appliances, devices, or systems where malfunction of these products can reasonably be expected to result in personal injury. Philips customers using or selling these products for use in such applications do so at their own risk and agree to fully indemnify Philips for any damages resulting from such improper use or sale.

Silicon temperature sensors

KTY84-1 series

NOTES

Silicon temperature sensors

KTY84-1 series

NOTES

Silicon temperature sensors

KTY84-1 series

NOTES

Philips Semiconductors – a worldwide company

Argentina: see South America

Australia: 34 Waterloo Road, NORTH RYDE, NSW 2113, Tel. +61 2 9805 4455, Fax. +61 2 9805 4466

Austria: Computerstr. 6, A-1101 WIEN, P.O. Box 213, Tel. +43 160 1010, Fax. +43 160 101 1210

Belarus: Hotel Minsk Business Center, Bld. 3, r. 1211, Volodarski Str. 6, 220050 MINSK, Tel. +375 172 200 733, Fax. +375 172 200 773

Belgium: see The Netherlands

Brazil: see South America

Bulgaria: Philips Bulgaria Ltd., Energoproject, 15th floor, 51 James Bourchier Blvd., 1407 SOFIA, Tel. +359 2 689 211, Fax. +359 2 689 102

Canada: PHILIPS SEMICONDUCTORS/COMPONENTS, Tel. +1 800 234 7381

China/Hong Kong: 501 Hong Kong Industrial Technology Centre, 72 Tat Chee Avenue, Kowloon Tong, HONG KONG, Tel. +852 2319 7888, Fax. +852 2319 7700

Colombia: see South America

Czech Republic: see Austria

Denmark: Prags Boulevard 80, PB 1919, DK-2300 COPENHAGEN S, Tel. +45 32 88 2636, Fax. +45 31 57 0044

Finland: Sinikalliontie 3, FIN-02630 ESPOO, Tel. +358 9 615800, Fax. +358 9 61580920

France: 51 Rue Carnot, BP317, 92156 SURESNES Cedex, Tel. +33 1 40 99 6161, Fax. +33 1 40 99 6427

Germany: Hammerbrookstraße 69, D-20097 HAMBURG, Tel. +49 40 23 53 60, Fax. +49 40 23 536 300

Greece: No. 15, 25th March Street, GR 17778 TAVROS/ATHENS, Tel. +30 1 4894 339/239, Fax. +30 1 4814 240

Hungary: see Austria

India: Philips INDIA Ltd, Band Box Building, 2nd floor, 254-D, Dr. Annie Besant Road, Worli, MUMBAI 400 025, Tel. +91 22 493 8541, Fax. +91 22 493 0966

Indonesia: PT Philips Development Corporation, Semiconductors Division, Gedung Philips, Jl. Buncit Raya Kav.99-100, JAKARTA 12510, Tel. +62 21 794 0040 ext. 2501, Fax. +62 21 794 0080

Ireland: Newstead, Clonskeagh, DUBLIN 14, Tel. +353 1 7640 000, Fax. +353 1 7640 200

Israel: RAPAC Electronics, 7 Kehilat Saloniki St, PO Box 18053, TEL AVIV 61180, Tel. +972 3 645 0444, Fax. +972 3 649 1007

Italy: PHILIPS SEMICONDUCTORS, Piazza IV Novembre 3, 20124 MILANO, Tel. +39 2 6752 2531, Fax. +39 2 6752 2557

Japan: Philips Bldg 13-37, Kohnan 2-chome, Minato-ku, TOKYO 108, Tel. +81 3 3740 5130, Fax. +81 3 3740 5077

Korea: Philips House, 260-199 Itaewon-dong, Yongsan-ku, SEOUL, Tel. +82 2 709 1412, Fax. +82 2 709 1415

Malaysia: No. 76 Jalan Universiti, 46200 PETALING JAYA, SELANGOR, Tel. +60 3 750 5214, Fax. +60 3 757 4880

Mexico: 5900 Gateway East, Suite 200, EL PASO, TEXAS 79905, Tel. +9-5 800 234 7381

Middle East: see Italy

Netherlands: Postbus 90050, 5600 PB EINDHOVEN, Bldg. VB, Tel. +31 40 27 82785, Fax. +31 40 27 88399

New Zealand: 2 Wagener Place, C.P.O. Box 1041, AUCKLAND, Tel. +64 9 849 4160, Fax. +64 9 849 7811

Norway: Box 1, Manglerud 0612, OSLO, Tel. +47 22 74 8000, Fax. +47 22 74 8341

Pakistan: see Singapore

Philippines: Philips Semiconductors Philippines Inc., 106 Valero St. Salcedo Village, P.O. Box 2108 MCC, MAKATI, Metro MANILA, Tel. +63 2 816 6380, Fax. +63 2 817 3474

Poland: Ul. Lukiska 10, PL 04-123 WARSZAWA, Tel. +48 22 612 2831, Fax. +48 22 612 2327

Portugal: see Spain

Romania: see Italy

Russia: Philips Russia, Ul. Usatcheva 35A, 119048 MOSCOW, Tel. +7 095 755 6918, Fax. +7 095 755 6919

Singapore: Lorong 1, Toa Payoh, SINGAPORE 319762, Tel. +65 350 2538, Fax. +65 251 6500

Slovakia: see Austria

Slovenia: see Italy

South Africa: S.A. PHILIPS Pty Ltd., 195-215 Main Road Martindale, 2092 JOHANNESBURG, P.O. Box 7430 Johannesburg 2000, Tel. +27 11 470 5911, Fax. +27 11 470 5494

South America: Al. Vicente Pinzon, 173, 6th floor, 04547-130 SÃO PAULO, SP, Brazil, Tel. +55 11 821 2333, Fax. +55 11 821 2382

Spain: Balmes 22, 08007 BARCELONA, Tel. +34 3 301 6312, Fax. +34 3 301 4107

Sweden: Kottbygatan 7, Akalla, S-16485 STOCKHOLM, Tel. +46 8 5985 2000, Fax. +46 8 5985 2745

Switzerland: Allmendstrasse 140, CH-8027 ZÜRICH, Tel. +41 1 488 2741 Fax. +41 1 488 3263

Taiwan: Philips Semiconductors, 6F, No. 96, Chien Kuo N. Rd., Sec. 1, TAIPEI, Taiwan Tel. +886 2 2134 2865, Fax. +886 2 2134 2874

Thailand: PHILIPS ELECTRONICS (THAILAND) Ltd., 209/2 Sanpavuth-Bangna Road Prakanong, BANGKOK 10260, Tel. +66 2 745 4090, Fax. +66 2 398 0793

Turkey: Talatpasa Cad. No. 5, 80640 GÜLTEPE/ISTANBUL, Tel. +90 212 279 2770, Fax. +90 212 282 6707

Ukraine: PHILIPS UKRAINE, 4 Patrice Lumumba str., Building B, Floor 7, 252042 KIEV, Tel. +380 44 264 2776, Fax. +380 44 268 0461

United Kingdom: Philips Semiconductors Ltd., 276 Bath Road, Hayes, MIDDLESEX UB3 5BX, Tel. +44 181 730 5000, Fax. +44 181 754 8421

United States: 811 East Arques Avenue, SUNNYVALE, CA 94088-3409, Tel. +1 800 234 7381

Uruguay: see South America

Vietnam: see Singapore

Yugoslavia: PHILIPS, Trg N. Pasica 5/v, 11000 BEOGRAD, Tel. +381 11 625 344, Fax. +381 11 635 777

For all other countries apply to: Philips Semiconductors, International Marketing & Sales Communications, Building BE-p, P.O. Box 218, 5600 MD EINDHOVEN, The Netherlands, Fax. +31 40 27 24825

Internet: <http://www.semiconductors.philips.com>

© Philips Electronics N.V. 1998

SCA59

All rights are reserved. Reproduction in whole or in part is prohibited without the prior written consent of the copyright owner.

The information presented in this document does not form part of any quotation or contract, is believed to be accurate and reliable and may be changed without notice. No liability will be accepted by the publisher for any consequence of its use. Publication thereof does not convey nor imply any license under patent- or other industrial or intellectual property rights.

Printed in The Netherlands

115106/00/03/pp12

Date of release: 1998 Apr 09

Document order number: 9397 750 03635

Let's make things better.

**Philips
Semiconductors**



PHILIPS

SUNSTAR 商斯达实业集团是集研发、生产、工程、销售、代理经销、技术咨询、信息服务等为一体的高科技企业，是专业高科技电子产品生产厂家，是具有 10 多年历史的专业电子元器件供应商，是中国最早和最大的仓储式连锁规模经营大型综合电子零部件代理分销商之一，是一家专业代理和分销世界各大品牌 IC 芯片和电子元器件的连锁经营综合性国际公司，专业经营进口、国产名厂名牌电子元件，型号、种类齐全。在香港、北京、深圳、上海、西安、成都等全国主要电子市场设有直属分公司和产品展示展销窗口门市部专卖店及代理分销商，已在全国范围内建成强大统一的供货和代理分销网络。我们专业代理经销、开发生产电子元器件、集成电路、传感器、微波光电元器件、工控机/DOC/DOM 电子盘、专用电路、单片机开发、MCU/DSP/ARM/FPGA 软件硬件、二极管、三极管、模块等，是您可靠的一站式现货配套供应商、方案提供商、部件功能模块开发配套商。商斯达实业公司拥有庞大的资料库，有数位毕业于著名高校——有中国电子工业摇篮之称的西安电子科技大学（西军电）并长期从事国防尖端科技研究的高级工程师为您精挑细选、量身订做各种高科技电子元器件，并解决各种技术问题。

微波光电部专业代理经销高频、微波、光纤、光电元器件、组件、部件、模块、整机；电磁兼容元器件、材料、设备；微波 CAD、EDA 软件、开发测试仿真工具；微波、光纤仪器仪表。欢迎国外高科技微波、光纤厂商将优秀产品介绍到中国、共同开拓市场。长期大量现货专业批发高频、微波、卫星、光纤、电视、CATV 器件：晶振、VCO、连接器、PIN 开关、变容二极管、开关二极管、低噪晶体管、功率电阻及电容、放大器、功率管、MMIC、混频器、耦合器、功分器、振荡器、合成器、衰减器、滤波器、隔离器、环行器、移相器、调制解调器；光电子元件和组件：红外发射管、红外接收管、光电开关、光敏管、发光二极管和发光二极管组件、半导体激光二极管和激光器组件、光电探测器和光接收组件、光发射接收模块、光纤激光器和光放大器、光调制器、光开关、DWDM 用光发射和接收器件、用户接入系统光收发器件与模块、光纤连接器、光纤跳线/尾纤、光衰减器、光纤适配器、光隔离器、光耦合器、光环行器、光复用器/转换器；无线收发芯片和模组、蓝牙芯片和模组。

更多产品请看本公司产品专用销售网站：

商斯达中国传感器科技信息网：<http://www.sensor-ic.com/>

商斯达工控安防网：<http://www.pc-ps.net/>

商斯达电子元器件网：<http://www.sunstare.com/>

商斯达微波光电产品网：[HTTP://www.rfoe.net/](http://www.rfoe.net/)

商斯达消费电子产品网：[//www.icasic.com/](http://www.icasic.com/)

商斯达实业科技产品网：[//www.sunstars.cn/](http://www.sunstars.cn/) 微波元器件销售热线：

地址：深圳市福田区福华路福庆街鸿图大厦 1602 室

电话：0755-82884100 83397033 83396822 83398585

传真：0755-83376182 (0) 13823648918 MSN: SUNS8888@hotmail.com

邮编：518033 E-mail:szss20@163.com QQ: 195847376

深圳赛格展销部：深圳华强北路赛格电子市场 2583 号 电话：0755-83665529 25059422

技术支持：0755-83394033 13501568376

欢迎索取免费详细资料、设计指南和光盘；产品凡多，未能尽录，欢迎来电查询。

北京分公司：北京海淀区知春路 132 号中发电子大厦 3097 号

TEL: 010-81159046 82615020 13501189838 FAX: 010-62543996

上海分公司：上海市北京东路 668 号上海赛格电子市场 D125 号

TEL: 021-28311762 56703037 13701955389 FAX: 021-56703037

西安分公司：西安高新开发区 20 所(中国电子科技集团导航技术研究所)

西安劳动南路 88 号电子商城二楼 D23 号

TEL: 029-81022619 13072977981 FAX:029-88789382