

To all our customers

---

## **Regarding the change of names mentioned in the document, such as Hitachi Electric and Hitachi XX, to Renesas Technology Corp.**

---

The semiconductor operations of Mitsubishi Electric and Hitachi were transferred to Renesas Technology Corporation on April 1st 2003. These operations include microcomputer, logic, analog and discrete devices, and memory chips other than DRAMs (flash memory, SRAMs etc.) Accordingly, although Hitachi, Hitachi, Ltd., Hitachi Semiconductors, and other Hitachi brand names are mentioned in the document, these names have in fact all been changed to Renesas Technology Corp. Thank you for your understanding. Except for our corporate trademark, logo and corporate statement, no changes whatsoever have been made to the contents of the document, and these changes do not constitute any alteration to the contents of the document itself.

Renesas Technology Home Page: <http://www.renesas.com>

Renesas Technology Corp.  
Customer Support Dept.  
April 1, 2003

## Cautions

Keep safety first in your circuit designs!

1. Renesas Technology Corporation puts the maximum effort into making semiconductor products better and more reliable, but there is always the possibility that trouble may occur with them. Trouble with semiconductors may lead to personal injury, fire or property damage.  
Remember to give due consideration to safety when making your circuit designs, with appropriate measures such as (i) placement of substitutive, auxiliary circuits, (ii) use of nonflammable material or (iii) prevention against any malfunction or mishap.

Notes regarding these materials

1. These materials are intended as a reference to assist our customers in the selection of the Renesas Technology Corporation product best suited to the customer's application; they do not convey any license under any intellectual property rights, or any other rights, belonging to Renesas Technology Corporation or a third party.
2. Renesas Technology Corporation assumes no responsibility for any damage, or infringement of any third-party's rights, originating in the use of any product data, diagrams, charts, programs, algorithms, or circuit application examples contained in these materials.
3. All information contained in these materials, including product data, diagrams, charts, programs and algorithms represents information on products at the time of publication of these materials, and are subject to change by Renesas Technology Corporation without notice due to product improvements or other reasons. It is therefore recommended that customers contact Renesas Technology Corporation or an authorized Renesas Technology Corporation product distributor for the latest product information before purchasing a product listed herein.  
The information described here may contain technical inaccuracies or typographical errors. Renesas Technology Corporation assumes no responsibility for any damage, liability, or other loss rising from these inaccuracies or errors.  
Please also pay attention to information published by Renesas Technology Corporation by various means, including the Renesas Technology Corporation Semiconductor home page (<http://www.renesas.com>).
4. When using any or all of the information contained in these materials, including product data, diagrams, charts, programs, and algorithms, please be sure to evaluate all information as a total system before making a final decision on the applicability of the information and products. Renesas Technology Corporation assumes no responsibility for any damage, liability or other loss resulting from the information contained herein.
5. Renesas Technology Corporation semiconductors are not designed or manufactured for use in a device or system that is used under circumstances in which human life is potentially at stake. Please contact Renesas Technology Corporation or an authorized Renesas Technology Corporation product distributor when considering the use of a product contained herein for any specific purposes, such as apparatus or systems for transportation, vehicular, medical, aerospace, nuclear, or undersea repeater use.
6. The prior written approval of Renesas Technology Corporation is necessary to reprint or reproduce in whole or in part these materials.
7. If these products or technologies are subject to the Japanese export control restrictions, they must be exported under a license from the Japanese government and cannot be imported into a country other than the approved destination.  
Any diversion or reexport contrary to the export control laws and regulations of Japan and/or the country of destination is prohibited.
8. Please contact Renesas Technology Corporation for further details on these materials or the products contained therein.

Hitachi 16-Bit Single-Chip Microcomputer

**H8S/2600 Series,  
H8S/2000 Series**

Programming Manual

**RENESAS**

ADE-602-083B

Rev. 3.0

7/14/2000

Hitachi, Ltd.

## Cautions

1. Hitachi neither warrants nor grants licenses of any rights of Hitachi's or any third party's patent, copyright, trademark, or other intellectual property rights for information contained in this document. Hitachi bears no responsibility for problems that may arise with third party's rights, including intellectual property rights, in connection with use of the information contained in this document.
2. Products and product specifications may be subject to change without notice. Confirm that you have received the latest product standards or specifications before final design, purchase or use.
3. Hitachi makes every attempt to ensure that its products are of high quality and reliability. However, contact Hitachi's sales office before using the product in an application that demands especially high quality and reliability or where its failure or malfunction may directly threaten human life or cause risk of bodily injury, such as aerospace, aeronautics, nuclear power, combustion control, transportation, traffic, safety equipment or medical equipment for life support.
4. Design your application so that the product is used within the ranges guaranteed by Hitachi particularly for maximum rating, operating supply voltage range, heat radiation characteristics, installation conditions and other characteristics. Hitachi bears no responsibility for failure or damage when used beyond the guaranteed ranges. Even within the guaranteed ranges, consider normally foreseeable failure rates or failure modes in semiconductor devices and employ systemic measures such as fail-safes, so that the equipment incorporating Hitachi product does not cause bodily injury, fire or other consequential damage due to operation of the Hitachi product.
5. This product is not designed to be radiation resistant.
6. No one is permitted to reproduce or duplicate, in any form, the whole or part of this document without written approval from Hitachi.
7. Contact Hitachi's sales office for any questions regarding this document or Hitachi semiconductor products.

# Preface

The H8S/2600 Series and the H8S/2000 Series are built around an H8S/2000 CPU core.

The H8S/2600 and H8S/2000 CPUs have the same internal 32-bit architecture. Both CPUs execute basic instructions in one state, have sixteen 16-bit registers, and have a concise, optimized instruction set. They can address a 16-Mbyte linear address space. Programs coded in the high-level language C can be compiled to high-speed executable code.

For easy migration, the instruction set is upward-compatible with the H8/300H, H8/300, and H8/300L Series at the object-code level.

The H8S/2600 CPU is upward-compatible with the H8S/2000 CPU at the object-code level, and supports sum of products instructions.

This manual gives details of the H8S/2600 and H8S/2000 instructions and can be used with all microcontrollers in the H8S/2600 Series and the H8S/2000 Series.

For hardware details, refer to the relevant microcontroller hardware manuals.



# Main Revisions and Additions in this Edition

<b>Page</b>	<b>Item</b>	<b>Revisions (See Manual for Details)</b>
—	All	Notes on TAS Instruction added Only register ER0, ER1, ER4, or ER5 should be used when using the TAS instruction.





# Contents

Section 1	CPU .....	1
1.1	Overview .....	1
1.1.1	Features .....	1
1.1.2	Differences between H8S/2600 CPU and H8S/2000 CPU.....	2
1.1.3	Differences from H8/300 CPU.....	3
1.1.4	Differences from H8/300H CPU.....	4
1.2	CPU Operating Modes .....	5
1.3	Address Space .....	10
1.4	Register Configuration .....	11
1.4.1	Overview .....	11
1.4.2	General Registers .....	12
1.4.3	Control Registers.....	13
1.4.4	Initial Register Values.....	15
1.5	Data Formats .....	16
1.5.1	General Register Data Formats .....	16
1.5.2	Memory Data Formats .....	18
1.6	Instruction Set .....	19
1.6.1	Overview .....	19
1.6.2	Instructions and Addressing Modes .....	20
1.6.3	Table of Instructions Classified by Function.....	22
1.6.4	Basic Instruction Formats.....	32
1.7	Addressing Modes and Effective Address Calculation .....	33
Section 2	Instruction Descriptions.....	41
2.1	Tables and Symbols.....	41
2.1.1	Assembly-Language Format .....	42
2.1.2	Operation.....	43
2.1.3	Condition Code .....	44
2.1.4	Instruction Format.....	44
2.1.5	Register Specification .....	45
2.1.6	Bit Data Access in Bit Manipulation Instructions.....	46
2.2	Instruction Descriptions .....	47
2.2.1 (1)	ADD (B).....	48
2.2.1 (2)	ADD (W).....	49
2.2.1 (3)	ADD (L).....	50
2.2.2	ADDS .....	51
2.2.3	ADDX .....	52
2.2.4 (1)	AND (B).....	53
2.2.4 (2)	AND (W).....	54

2.2.4 (3)	AND (L)	55
2.2.5 (1)	ANDC	56
2.2.5 (2)	ANDC	57
2.2.6	BAND	58
2.2.7	Bcc	60
2.2.8	BCLR	62
2.2.9	BIAND	64
2.2.10	BILD	66
2.2.11	BIOR	68
2.2.12	BIST	70
2.2.13	BIXOR	72
2.2.14	BLD	74
2.2.15	BNOT	76
2.2.16	BOR	78
2.2.17	BSET	80
2.2.18	BSR	82
2.2.19	BST	84
2.2.20	BTST	86
2.2.21	BXOR	88
2.2.22	CLRMAC	90
2.2.23 (1)	CMP (B)	91
2.2.23 (2)	CMP (W)	92
2.2.23 (3)	CMP (L)	93
2.2.24	DAA	94
2.2.25	DAS	96
2.2.26 (1)	DEC (B)	98
2.2.26 (2)	DEC (W)	99
2.2.26 (3)	DEC (L)	100
2.2.27 (1)	DIVXS (B)	101
2.2.27 (2)	DIVXS (W)	103
2.2.28 (1)	DIVXU (B)	105
2.2.28 (2)	DIVXU (W)	107
2.2.29 (1)	EEPMOV (B)	109
2.2.29 (2)	EEPMOV (W)	110
2.2.30 (1)	EXTS (W)	112
2.2.30 (2)	EXTS (L)	113
2.2.31 (1)	EXTU (W)	114
2.2.31 (2)	EXTU (L)	115
2.2.32 (1)	INC (B)	116
2.2.32 (2)	INC (W)	117
2.2.32 (3)	INC (L)	118
2.2.33	JMP	119
2.2.34	JSR	120

2.2.35 (1) LDC (B).....	122
2.2.35 (2) LDC (B).....	123
2.2.35 (3) LDC (W).....	124
2.2.35 (4) LDC (W).....	126
2.2.36 LDM.....	128
2.2.37 LDMAC.....	130
2.2.38 MAC.....	131
2.2.39 (1) MOV (B).....	134
2.2.39 (2) MOV (W).....	135
2.2.39 (3) MOV (L).....	136
2.2.39 (4) MOV (B).....	137
2.2.39 (5) MOV (W).....	139
2.2.39 (6) MOV (L).....	141
2.2.39 (7) MOV (B).....	143
2.2.39 (8) MOV (W).....	145
2.2.39 (9) MOV (L).....	147
2.2.40 MOVFPE.....	149
2.2.41 MOVTPPE.....	150
2.2.42 (1) MULXS (B).....	151
2.2.42 (2) MULXS (W).....	152
2.2.43 (1) MULXU (B).....	153
2.2.43 (2) MULXU (W).....	154
2.2.44 (1) NEG (B).....	155
2.2.44 (2) NEG (W).....	156
2.2.44 (3) NEG (L).....	157
2.2.45 NOP.....	158
2.2.46 (1) NOT (B).....	159
2.2.46 (2) NOT (W).....	160
2.2.46 (3) NOT (L).....	161
2.2.47 (1) OR (B).....	162
2.2.47 (2) OR (W).....	163
2.2.47 (3) OR (L).....	164
2.2.48 (1) ORC.....	165
2.2.48 (2) ORC.....	166
2.2.49 (1) POP (W).....	167
2.2.49 (2) POP (L).....	168
2.2.50 (1) PUSH (W).....	169
2.2.50 (2) PUSH (L).....	170
2.2.51 (1) ROTL (B).....	171
2.2.51 (2) ROTL (B).....	172
2.2.51 (3) ROTL (W).....	173
2.2.51 (4) ROTL (W).....	174
2.2.51 (5) ROTL (L).....	175

2.2.51 (6) ROTL (L) .....	176
2.2.52 (1) ROTR (B) .....	177
2.2.52 (2) ROTR (B) .....	178
2.2.52 (3) ROTR (W) .....	179
2.2.52 (4) ROTR (W) .....	180
2.2.52 (5) ROTR (L) .....	181
2.2.52 (6) ROTR (L) .....	182
2.2.53 (1) ROTXL (B) .....	183
2.2.53 (2) ROTXL (B) .....	184
2.2.53 (3) ROTXL (W) .....	185
2.2.53 (4) ROTXL (W) .....	186
2.2.53 (5) ROTXL (L) .....	187
2.2.53 (6) ROTXL (L) .....	188
2.2.54 (1) ROTXR (B) .....	189
2.2.54 (2) ROTXR (B) .....	190
2.2.54 (3) ROTXR (W) .....	191
2.2.54 (4) ROTXR (W) .....	192
2.2.54 (5) ROTXR (L) .....	193
2.2.54 (6) ROTXR (L) .....	194
2.2.55 RTE .....	195
2.2.56 RTS .....	197
2.2.57 (1) SHAL (B) .....	198
2.2.57 (2) SHAL (B) .....	199
2.2.57 (3) SHAL (W) .....	200
2.2.57 (4) SHAL (W) .....	201
2.2.57 (5) SHAL (L) .....	202
2.2.57 (6) SHAL (L) .....	203
2.2.58 (1) SHAR (B) .....	204
2.2.58 (2) SHAR (B) .....	205
2.2.58 (3) SHAR (W) .....	206
2.2.58 (4) SHAR (W) .....	207
2.2.58 (5) SHAR (L) .....	208
2.2.58 (6) SHAR (L) .....	209
2.2.59 (1) SHLL (B) .....	210
2.2.59 (2) SHLL (B) .....	211
2.2.59 (3) SHLL (W) .....	212
2.2.59 (4) SHLL (W) .....	213
2.2.59 (5) SHLL (L) .....	214
2.2.59 (6) SHLL (L) .....	215
2.2.60 (1) SHLR (B) .....	216
2.2.60 (2) SHLR (B) .....	217
2.2.60 (3) SHLR (W) .....	218
2.2.60 (4) SHLR (W) .....	219

2.2.60 (5) SHLR (L).....	220
2.2.60 (6) SHLR (L).....	221
2.2.61 SLEEP .....	222
2.2.62 (1) STC (B) .....	223
2.2.62 (2) STC (B) .....	224
2.2.62 (3) STC (W) .....	225
2.2.62 (4) STC (W) .....	227
2.2.63 STM.....	229
2.2.64 STMAC .....	231
2.2.65 (1) SUB (B).....	233
2.2.65 (2) SUB (W).....	235
2.2.65 (3) SUB (L) .....	236
2.2.66 SUBS .....	237
2.2.67 SUBX .....	238
2.2.68 TAS .....	239
2.2.69 TRAPA.....	240
2.2.70 (1) XOR (B) .....	242
2.2.70 (2) XOR (W) .....	243
2.2.70 (3) XOR (L) .....	244
2.2.71 (1) XORC.....	245
2.2.71 (2) XORC.....	246
2.3 Instruction Set .....	247
2.4 Instruction Code .....	263
2.5 Operation Code Map .....	274
2.6 Number of States Required for Instruction Execution .....	278
2.7 Bus States During Instruction Execution.....	290
2.8 Condition Code Modification.....	304
<b>Section 3 Processing States .....</b>	<b>309</b>
3.1 Overview .....	309
3.2 Reset State .....	310
3.3 Exception-Handling State.....	311
3.3.1 Types of Exception Handling and Their Priority .....	311
3.3.2 Reset Exception Handling .....	312
3.3.3 Trace.....	312
3.3.4 Interrupt Exception Handling and Trap Instruction Exception Handling.....	312
3.4 Program Execution State .....	313
3.5 Bus-Released State .....	314
3.6 Power-Down State.....	314
3.6.1 Sleep Mode.....	314
3.6.2 Software Standby Mode .....	314
3.6.3 Hardware Standby Mode.....	314

Section 4	Basic Timing	315
4.1	Overview	315
4.2	On-Chip Memory (ROM, RAM)	315
4.3	On-Chip Supporting Module Access Timing	317
4.4	External Address Space Access Timing	318

# Section 1 CPU

## 1.1 Overview

The H8S/2600 CPU and the H8S/2000 CPU are high-speed central processing units with a common an internal 32-bit architecture. Each CPU is upward-compatible with the H8/300 and H8/300H CPUs. The H8S/2600 CPU and H8S/2000 CPU have sixteen 16-bit general registers, can address a 4-Gbyte linear address space, and are ideal for realtime control.

### 1.1.1 Features

The H8S/2600 CPU and H8S/2000 CPU have the following features.

- Upward-compatible with H8/300 and H8/300H CPUs
  - Can execute H8/300 and H8/300H object programs
- General-register architecture
  - Sixteen 16-bit general registers (also usable as sixteen 8-bit registers or eight 32-bit registers)
- Sixty-nine basic instructions (H8S/2000 CPU has sixty-five)
  - 8/16/32-bit arithmetic and logic instructions
  - Multiply and divide instructions
  - Powerful bit-manipulation instructions
  - Multiply-and-accumulate instruction (H8S/2600 CPU only)
- Eight addressing modes
  - Register direct [Rn]
  - Register indirect [@ERn]
  - Register indirect with displacement [@(d:16,ERn) or @(d:32,ERn)]
  - Register indirect with post-increment or pre-decrement [@ERn+ or @-ERn]
  - Absolute address [@aa:8, @aa:16, @aa:24, or @aa:32]
  - Immediate [#xx:8, #xx:16, or #xx:32]
  - Program-counter relative [@(d:8,PC) or @(d:16,PC)]
  - Memory indirect [@@aa:8]
- 4-Gbyte address space
  - Program: 16 Mbytes
  - Data: 4 Gbytes

- High-speed operation
  - All frequently-used instructions execute in one or two states
  - Maximum clock frequency: 20 MHz
  - 8/16/32-bit register-register add/subtract: 50 ns
  - $8 \times 8$ -bit register-register multiply: 150 ns (H8S/2000 CPU: 600 ns)
  - $16 \div 8$ -bit register-register divide: 600 ns
  - $16 \times 16$ -bit register-register multiply: 200 ns (H8S/2000 CPU: 1000 ns)
  - $32 \div 16$ -bit register-register divide: 1000 ns
- Two CPU operating modes
  - Normal mode
  - Advanced mode
- Power-down modes
  - Transition to power-down state by SLEEP instruction
  - CPU clock speed selection

### 1.1.2 Differences between H8S/2600 CPU and H8S/2000 CPU

Differences between the H8S/2600 CPU and the H8S/2000 CPU are as follows.

- Register configuration
  - The MAC register is supported only by the H8S/2600 CPU.  
For details, see section 1.4, Register Configuration.
- Basic instructions
  - The MAC, CLRMAC, LDMAC, and STMAC instructions are supported only by the H8S/2600 CPU.  
For details, see section 1.6, Instruction Set, and Section 2, Instruction Descriptions.
- Number of states required for execution
  - The number of states required for execution of the MULXU and MULXS instructions.  
For details, see section 2.6, Number of States Required for Execution.

In addition, there may be differences in address spaces, EXR register functions, power-down states, and so on. For details, refer to the relevant microcontroller hardware manual.



### 1.1.3 Differences from H8/300 CPU

In comparison with the H8/300 CPU, the H8S/2600 CPU and H8S/2000 CPU have the following enhancements.

- More general registers and control registers
  - Eight 16-bit registers, one 8-bit and two 32-bit control registers have been added.
- Expanded address space
  - Normal mode supports the same 64-kbyte address space as the H8/300 CPU.
  - Advanced mode supports a maximum 4-Gbyte address space.
- Enhanced addressing
  - The addressing modes have been enhanced to make effective use of the 4-Gbyte address space.
- Enhanced instructions
  - Addressing modes of bit-manipulation instructions have been enhanced.
  - Signed multiply and divide instructions have been added.
  - A multiply-and-accumulate instruction has been added. (H8S/2600CPU only)
  - Two-bit shift and rotate instructions have been added.
  - Instructions for saving and restoring multiple registers have been added.
  - A test and set instruction has been added.
- Higher speed
  - Basic instructions execute twice as fast.

### 1.1.4 Differences from H8/300H CPU

In comparison with the H8/300H CPU, the H8S/2600 CPU and H8S/2000 CPU have the following enhancements.

- Additional control register
  - One 8-bit and two 32-bit control registers have been added.
- Expanded address space
  - Advanced mode supports a maximum 4-Gbyte data address space.
- Enhanced instructions
  - Addressing modes of bit-manipulation instructions have been enhanced.
  - A multiply-and-accumulate instruction has been added (H8S/2600 CPU only).
  - Two-bit shift and rotate instructions have been added.
  - Instructions for saving and restoring multiple registers have been added.
  - A test and set instruction has been added.
- Higher speed
  - Basic instructions execute twice as fast.

## 1.2 CPU Operating Modes

Like the H8/300H CPU, the H8S/2600 CPU has two operating modes: normal and advanced. Normal mode supports a maximum 64-kbyte address space. Advanced mode supports a maximum 4-Gbyte total address space, of which up to 16 Mbytes can be used for program code and up to 4 Gbytes for data. The mode is selected with the mode pins of the microcontroller. For further information, refer to the relevant microcontroller hardware manual.

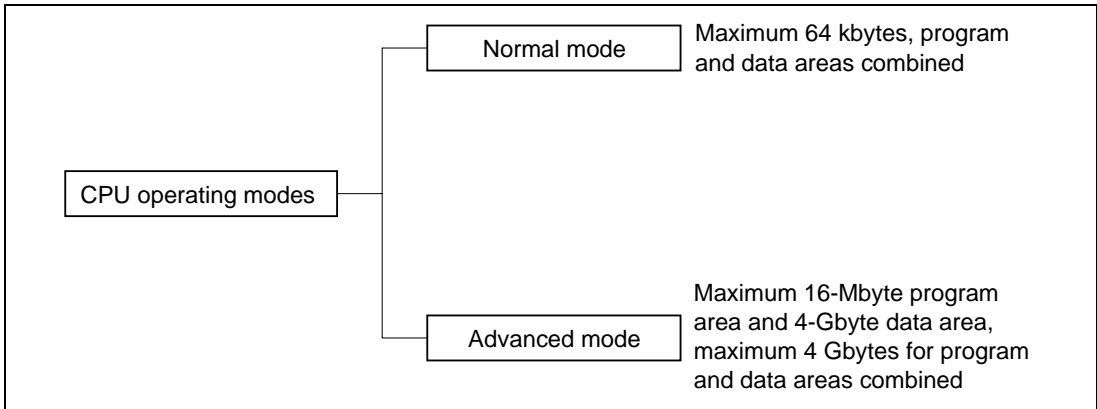

**Figure 1.1 CPU Operating Modes**

### (1) Normal Mode

The exception vector table and stack have the same structure as in the H8/300 CPU.

**Address Space:** A maximum address space of 64 kbytes can be accessed, as in the H8/300 CPU.

**Extended Registers (En):** The extended registers (E0 to E7) can be used as 16-bit registers, or as the upper 16-bit segments of 32-bit registers. When En is used as a 16-bit register it can contain any value, even when the corresponding general register (R0 to R7) is used as an address register. If the general register is referenced in the register indirect addressing mode with pre-decrement (@-Rn) or post-increment (@Rn+) and a carry or borrow occurs, however, the value in the corresponding extended register will be affected.

**Instruction Set:** All additional instructions and addressing modes not found in the H8/300 CPU can be used. Only the lower 16 bits of effective addresses (EA) are valid.

**Exception Vector Table and Memory Indirect Branch Addresses:** In normal mode the top area starting at H'0000 is allocated to the exception vector table. One branch address is stored per 16 bits (figure 1.2). The exception vector table differs depending on the microcontroller. Refer to the relevant microcontroller hardware manual for further information.

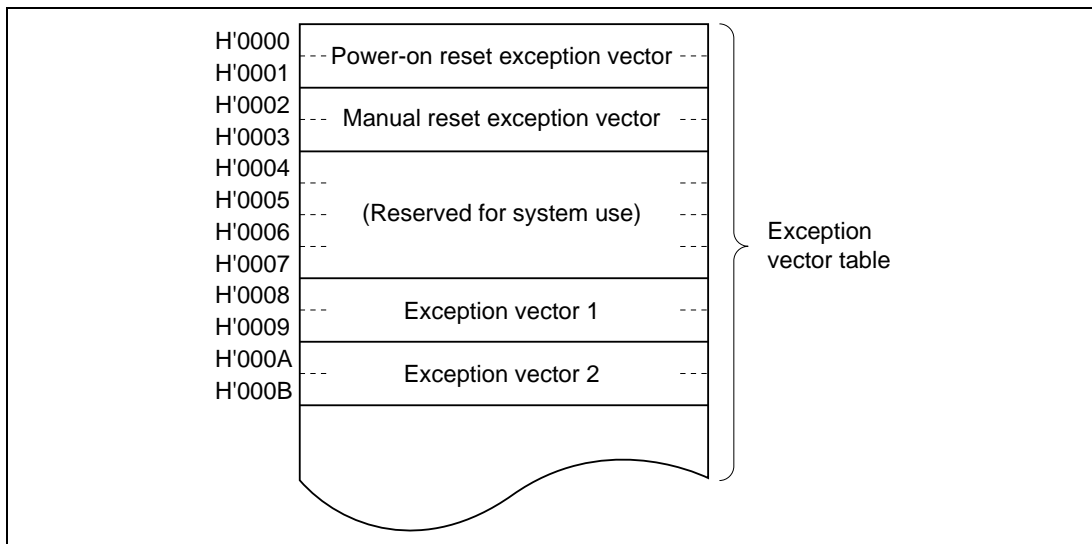

**Figure 1.2 Exception Vector Table (Normal Mode)**

The memory indirect addressing mode (@@aa:8) employed in the JMP and JSR instructions uses an 8-bit absolute address included in the instruction code to specify a memory operand that contains a branch address. In normal mode the operand is a 16-bit word operand, providing a 16-bit branch address. Branch addresses can be stored in the top area from H'0000 to H'00FF. Note that this area is also used for the exception vector table.

**Stack Structure:** When the program counter (PC) is pushed onto the stack in a subroutine call, and the PC, condition-code register (CCR), and extended control register (EXR) are pushed onto the stack in exception handling, they are stored as shown in figure 1.3. When EXR is invalid, it is not pushed onto the stack. For details, see the relevant hardware manual.

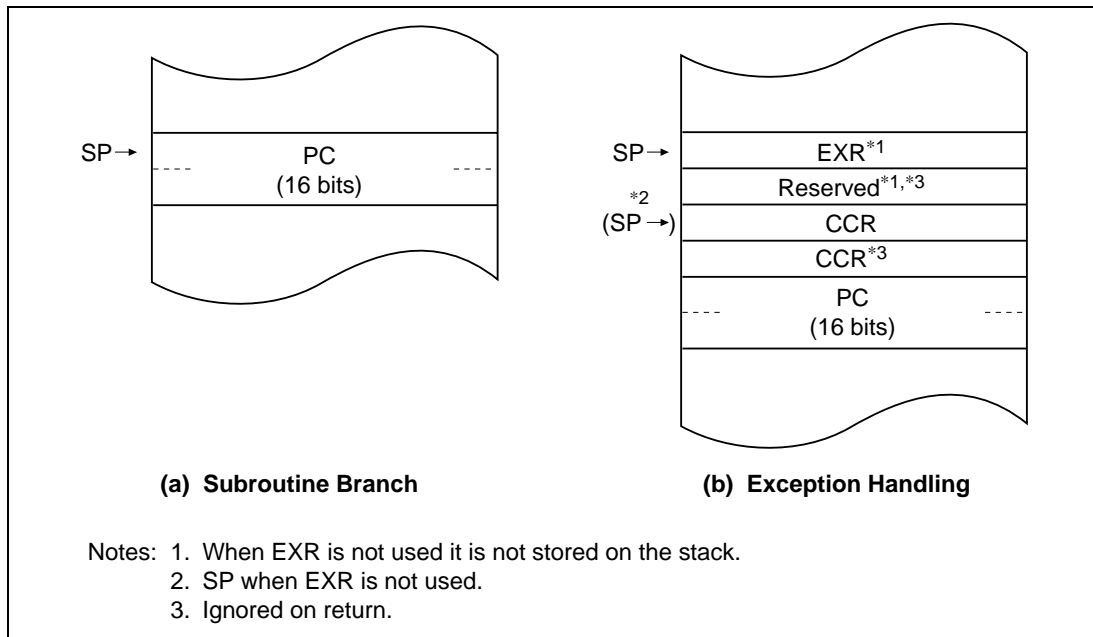

**Figure 1.3 Stack Structure in Normal Mode**

## (2) Advanced Mode

In advanced mode the data address space is larger than for the H8/300H CPU.

**Address Space:** The 4-Gbyte maximum address space provides linear access to a maximum 16 Mbytes of program code and maximum 4 Gbytes of data.

**Extended Registers (En):** The extended registers (E0 to E7) can be used as 16-bit registers, or as the upper 16-bit segments of 32-bit registers or address registers.

**Instruction Set:** All instructions and addressing modes can be used.

**Exception Vector Table and Memory Indirect Branch Addresses:** In advanced mode the top area starting at H'00000000 is allocated to the exception vector table in units of 32 bits. In each 32 bits, the upper 8 bits are ignored and a branch address is stored in the lower 24 bits (figure 1.4). The exception vector table differs depending on the microcontroller. Refer to the relevant microcontroller hardware manual for further information.

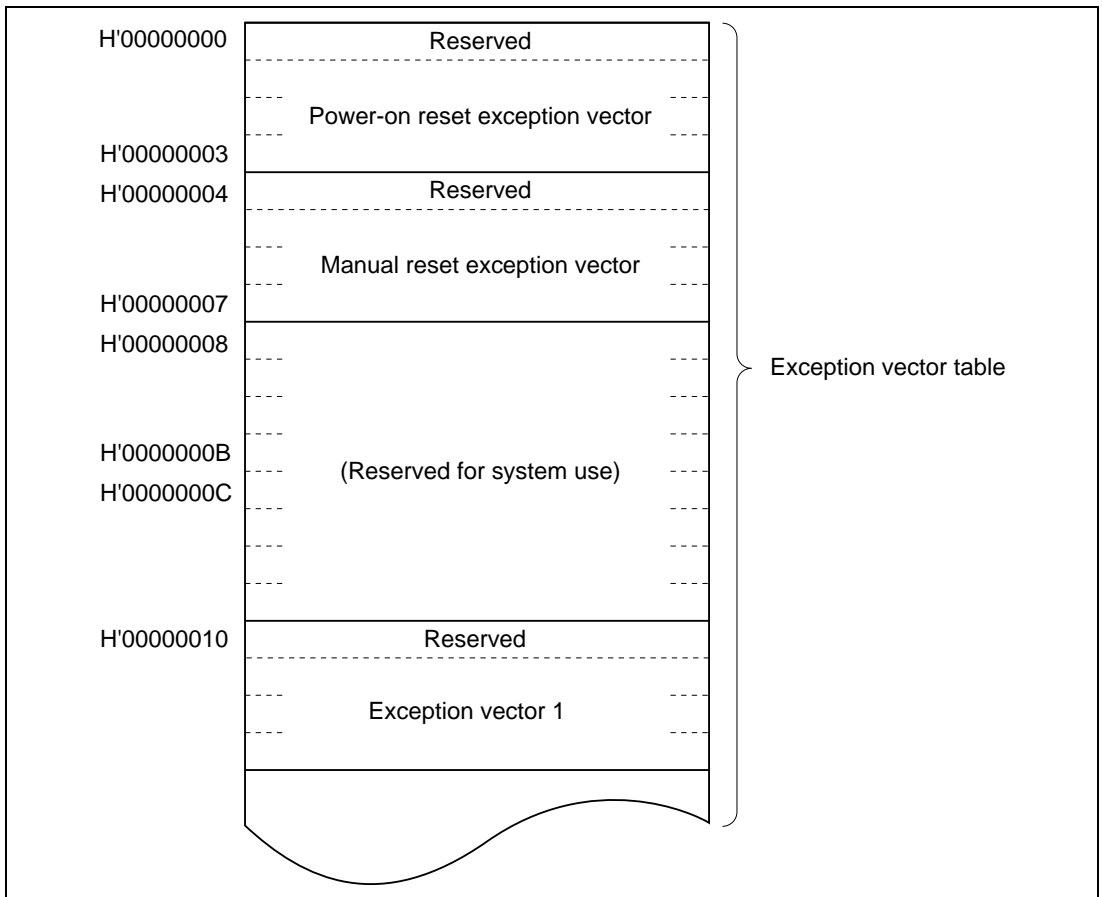

**Figure 1.4 Exception Vector Table (Advanced Mode)**

The memory indirect addressing mode (@@aa:8) employed in the JMP and JSR instructions uses an 8-bit absolute address included in the instruction code to specify a memory operand that contains a branch address. In advanced mode the operand is a 32-bit longword operand, providing a 32-bit branch address. The upper 8 bits of these 32 bits are a reserved area that is regarded as H'00. Branch addresses can be stored in the top area from H'00000000 to H'000000FF. Note that this area is also used for the exception vector table.

**Stack Structure:** In advanced mode, when the program counter (PC) is pushed onto the stack in a subroutine call, and the PC, condition-code register (CCR), and extended control register (EXR) are pushed onto the stack in exception handling, they are stored as shown in figure 1.5. When EXR is invalid, it is not pushed onto the stack. For details, see the relevant hardware manual.

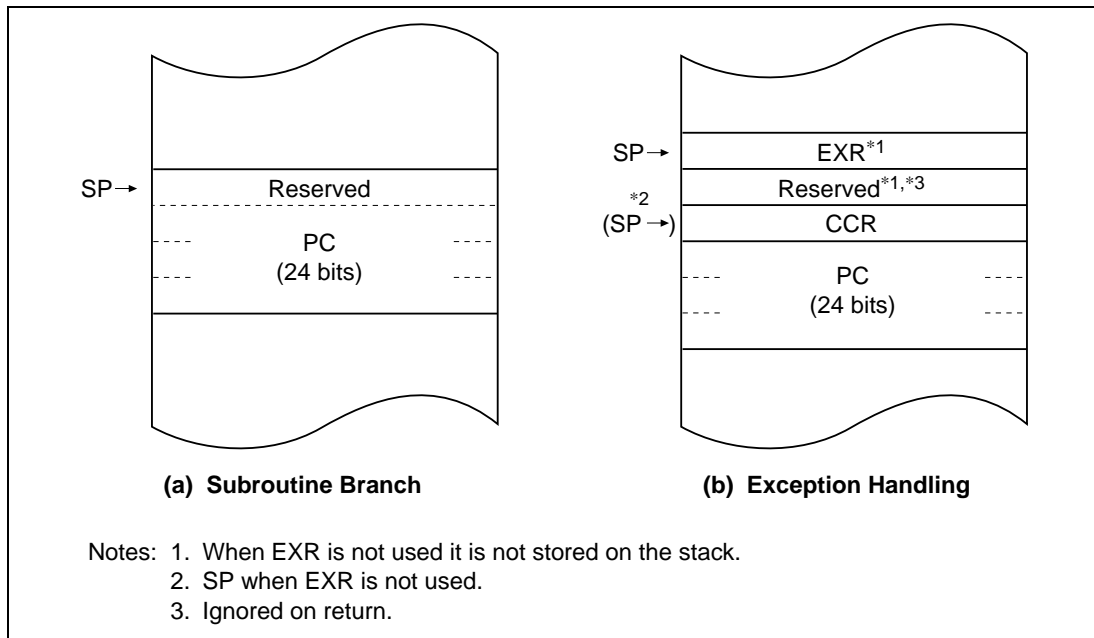

**Figure 1.5 Stack Structure in Advanced Mode**

## 1.3 Address Space

Figure 1.6 shows a memory map of the H8S/2600 CPU. The H8S/2600 CPU provides linear access to a maximum 64-kbyte address space in normal mode, and a maximum 4-Gbyte address space in advanced mode. The address space differs depending on the operating mode. For details, refer to the relevant microcontroller hardware manual.

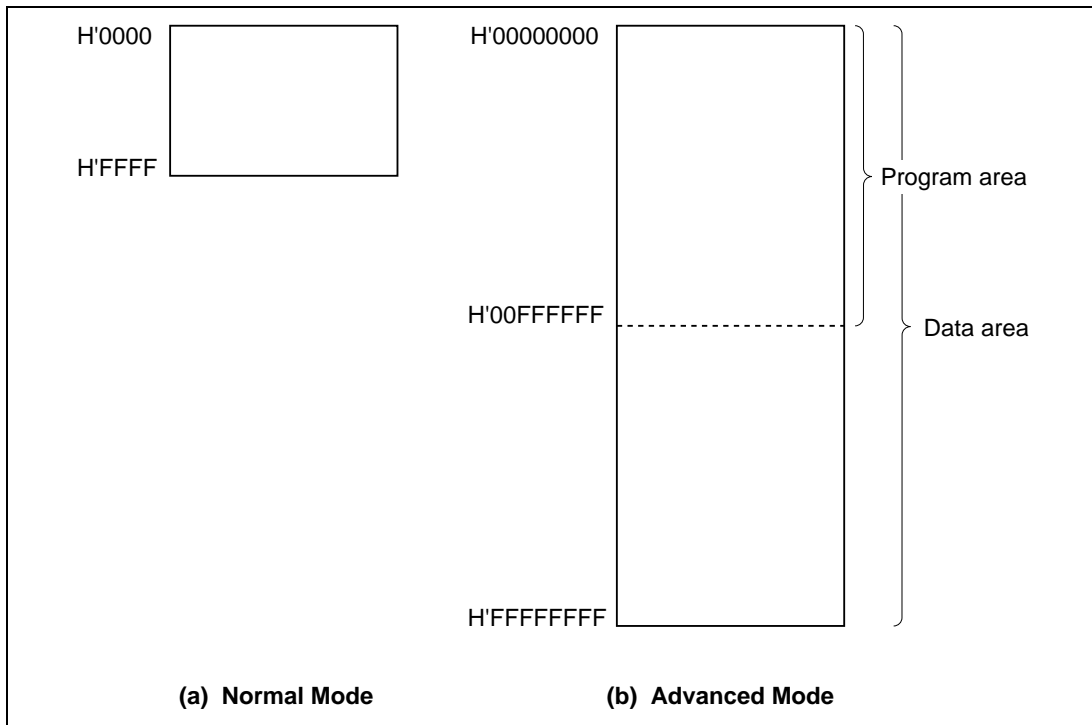

Figure 1.6 Memory Map



# 1.4 Register Configuration

## 1.4.1 Overview

The CPUs have the internal registers shown in figure 1.7. There are two types of registers: general registers and control registers. The H8S/2000 CPU does not support the MAC register.

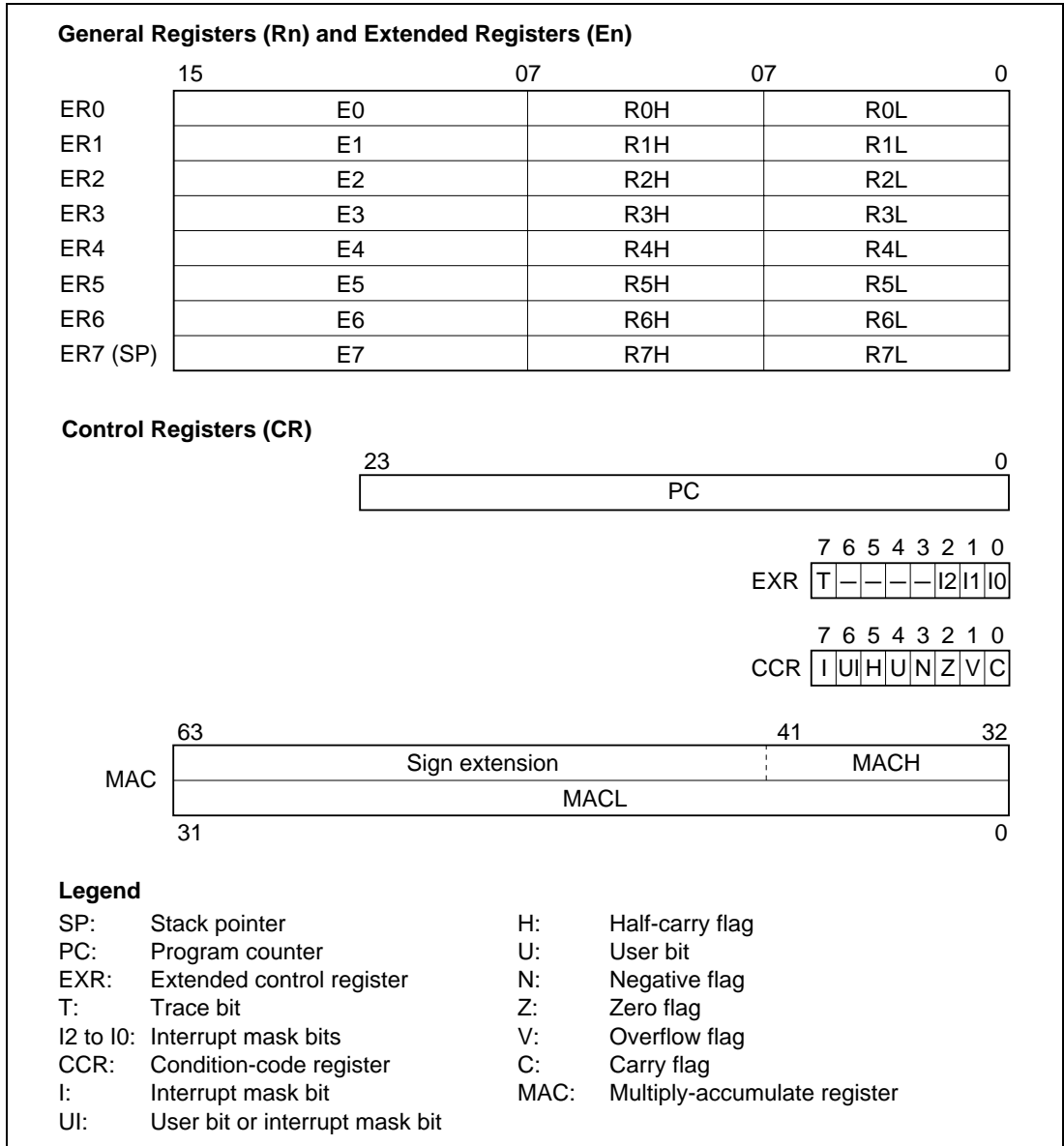

Figure 1.7 CPU Registers

## 1.4.2 General Registers

The CPUs have eight 32-bit general registers. These general registers are all functionally alike and can be used as both address registers and data registers. When a general register is used as a data register, it can be accessed as a 32-bit, 16-bit, or 8-bit register. When the general registers are used as 32-bit registers or address registers, they are designated by the letters ER (ER0 to ER7).

The ER registers divide into 16-bit general registers designated by the letters E (E0 to E7) and R (R0 to R7). These registers are functionally equivalent, providing a maximum sixteen 16-bit registers. The E registers (E0 to E7) are also referred to as extended registers.

The R registers divide into 8-bit general registers designated by the letters RH (R0H to R7H) and RL (R0L to R7L). These registers are functionally equivalent, providing a maximum sixteen 8-bit registers.

Figure 1.8 illustrates the usage of the general registers. The usage of each register can be selected independently.

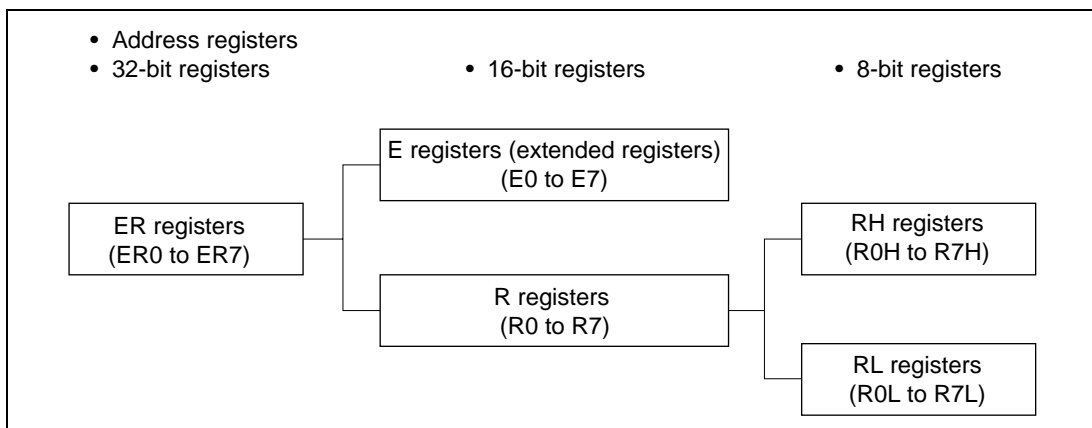

**Figure 1.8 Usage of General Registers**

General register ER7 has the function of stack pointer (SP) in addition to its general-register function, and is used implicitly in exception handling and subroutine calls. Figure 1.9 shows the stack.

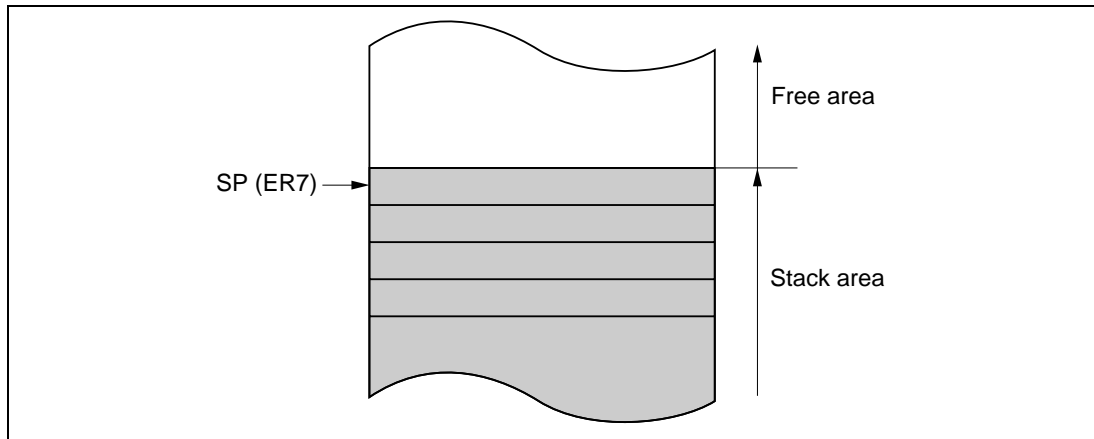

**Figure 1.9 Stack**

### 1.4.3 Control Registers

The control registers are the 24-bit program counter (PC), 8-bit extended control register (EXR), 8-bit condition-code register (CCR), and 64-bit multiply-accumulate register (MAC: H8S/2600 CPU only).

#### (1) Program Counter (PC)

This 24-bit counter indicates the address of the next instruction the CPU will execute. The length of all CPU instructions is 16 bits (one word) or a multiple of 16 bits, so the least significant PC bit is ignored. When an instruction is fetched, the least significant PC bit is regarded as 0.

#### (2) Extended Control Register (EXR)

This 8-bit register contains the trace bit (T) and three interrupt mask bits (I2 to I0).

**Bit 7—Trace Bit (T):** Selects trace mode. When this bit is cleared to 0, instructions are executed in sequence. When this bit is set to 1, a trace exception is generated each time an instruction is executed.

**Bits 6 to 3—Reserved:** These bits are reserved, always read as 1.

**Bits 2 to 0—Interrupt Mask Bits (I2 to I0):** These bits designate the interrupt mask level (0 to 7). For details refer to the relevant microcontroller hardware manual.

Operations can be performed on the EXR bits by the LDC, STC, ANDC, ORC, and XORC instructions. All interrupts, including NMI, are disabled for three states after one of these instructions is executed, except for STC.

### (3) Condition-Code Register (CCR)

This 8-bit register contains internal CPU status information, including an interrupt mask bit (I) and half-carry (H), negative (N), zero (Z), overflow (V), and carry (C) flags.

**Bit 7—Interrupt Mask Bit (I):** Masks interrupts other than NMI when set to 1. (NMI is accepted regardless of the I bit setting.) The I bit is set to 1 by hardware at the start of an exception-handling sequence.

**Bit 6—User Bit or Interrupt Mask Bit (UI):** Can be written and read by software using the LDC, STC, ANDC, ORC, and XORC instructions. This bit can also be used as an interrupt mask bit. For details refer to the relevant microcontroller hardware manual.

**Bit 5—Half-Carry Flag (H):** When the ADD.B, ADDX.B, SUB.B, SUBX.B, CMP.B, or NEG.B instruction is executed, this flag is set to 1 if there is a carry or borrow at bit 3, and cleared to 0 otherwise. When the ADD.W, SUB.W, CMP.W, or NEG.W instruction is executed, the H flag is set to 1 if there is a carry or borrow at bit 11, and cleared to 0 otherwise. When the ADD.L, SUB.L, CMP.L, or NEG.L instruction is executed, the H flag is set to 1 if there is a carry or borrow at bit 27, and cleared to 0 otherwise.

**Bit 4—User Bit (U):** Can be written and read by software using the LDC, STC, ANDC, ORC, and XORC instructions.

**Bit 3—Negative Flag (N):** Stores the value of the most significant bit (sign bit) of data.

**Bit 2—Zero Flag (Z):** Set to 1 to indicate zero data, and cleared to 0 to indicate non-zero data.

**Bit 1—Overflow Flag (V):** Set to 1 when an arithmetic overflow occurs, and cleared to 0 at other times.

**Bit 0—Carry Flag (C):** Set to 1 when a carry occurs, and cleared to 0 otherwise. Used by:

- Add instructions, to indicate a carry
- Subtract instructions, to indicate a borrow
- Shift and rotate instructions, to store the value shifted out of the end bit

The carry flag is also used as a bit accumulator by bit manipulation instructions.

Some instructions leave some or all of the flag bits unchanged. For the action of each instruction on the flag bits, refer to the detailed descriptions of the instructions starting in section 2.2.1.

Operations can be performed on the CCR bits by the LDC, STC, ANDC, ORC, and XORC instructions. The N, Z, V, and C flags are used as branching conditions for conditional branch (Bcc) instructions.

#### **(4) Multiply-Accumulate Register (MAC)**

The MAC register is supported only by the H8S/2600 CPU. This 64-bit register stores the results of multiply-and-accumulate operations. It consists of two 32-bit registers denoted MACH and MACL. The lower 10 bits of MACH are valid; the upper bits are a sign extension.

#### **1.4.4 Initial Register Values**

Reset exception handling loads the CPU's program counter (PC) from the vector table, clears the trace bit in EXR to 0, and sets the interrupt mask bits in CCR and EXR to 1. The other CCR bits and the general registers are not initialized. In particular, the stack pointer (ER7) is not initialized. The stack pointer should therefore be initialized by an MOV.L instruction executed immediately after a reset.

## 1.5 Data Formats

The CPUs can process 1-bit, 4-bit (BCD), 8-bit (byte), 16-bit (word), and 32-bit (longword) data. Bit-manipulation instructions operate on 1-bit data by accessing bit  $n$  ( $n = 0, 1, 2, \dots, 7$ ) of byte operand data. The DAA and DAS decimal-adjust instructions treat byte data as two digits of 4-bit BCD data.

### 1.5.1 General Register Data Formats

Figure 1.10 shows the data formats in general registers.

Data Type	Register Number	Data Format
1-bit data	RnH	
1-bit data	RnL	
4-bit BCD data	RnH	
4-bit BCD data	RnL	
Byte data	RnH	
Byte data	RnL	

Figure 1.10 General Register Data Formats

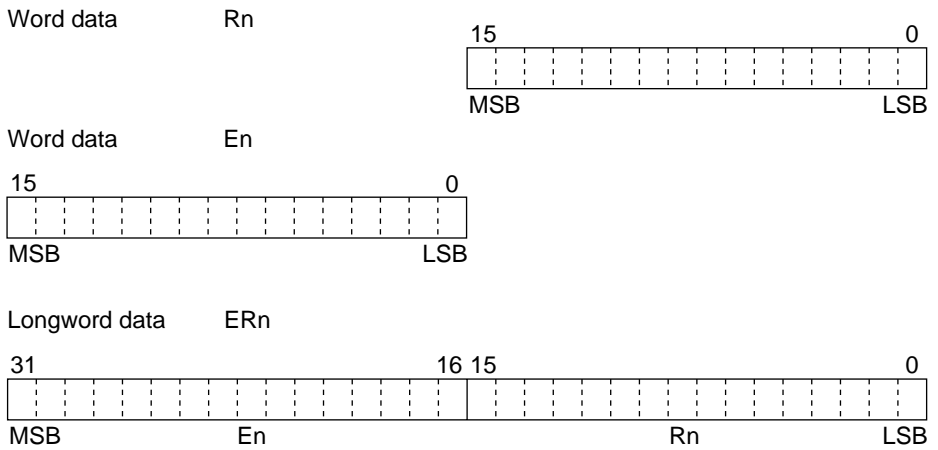

**Legend**

- ERn: General register ER
- En: General register E
- Rn: General register R
- RnH: General register RH
- RnL: General register RL
- MSB: Most significant bit
- LSB: Least significant bit

**Figure 1.10 General Register Data Formats (cont)**

## 1.5.2 Memory Data Formats

Figure 1.11 shows the data formats in memory. The CPU can access word data and longword data in memory, but word or longword data must begin at an even address. If an attempt is made to access word or longword data at an odd address, no address error occurs but the least significant bit of the address is regarded as 0, so the access starts at the preceding address. This also applies to instruction fetches.

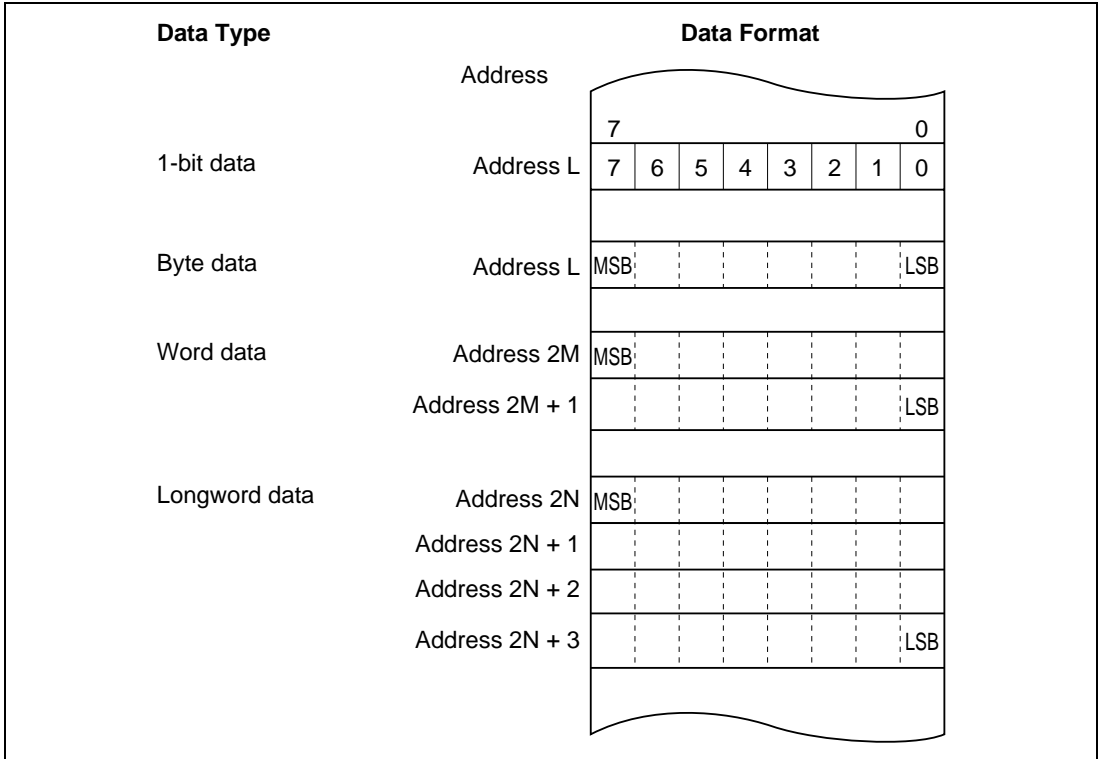

**Figure 1.11 Memory Data Formats**

When the stack pointer (ER7) is used as an address register to access the stack, the operand size should be word size or longword size.



## 1.6 Instruction Set

### 1.6.1 Overview

The H8S/2600 CPU has 69 types of instructions, while the H8S/2000 CPU has 65 types. The instructions are classified by function as shown in table 1.1. For a detailed description of each instruction, see section 2.2, Instruction Descriptions.

**Table 1.1 Instruction Classification**

Function	Instructions	Size	Types
Data transfer	MOV	BWL	5
	POP* <sup>2</sup> , PUSH* <sup>2</sup>	WL	
	LDM, STM	L	
	MOVFPE, MOVTPE	B	
Arithmetic operations	ADD, SUB, CMP, NEG	BWL	19
	ADDX, SUBX, DAA, DAS	B	
	INC, DEC	BWL	
	ADDS, SUBS	L	
	MULXU, DIVXU, MULXS, DIVXS	BW	
	EXTU, EXTS	WL	
	TAS* <sup>4</sup>	B	
	MAC, LDMAC, STMAC, CLRMAC* <sup>1</sup>	—	
Logic operations	AND, OR, XOR, NOT	BWL	4
Shift	SHAL, SHAR, SHLL, SHLR, ROTL, ROTR, ROTXL, ROTXR	BWL	8
Bit manipulation	BSET, BCLR, BNOT, BTST, BLD, BILD, BST, BIST, BAND, BIAND, BOR, BIOR, BXOR, BIXOR	B	14
Branch	Bcc* <sup>3</sup> , JMP, BSR, JSR, RTS	—	5
System control	TRAPA, RTE, SLEEP, LDC, STC, ANDC, ORC, XORC, NOP	—	9
Block data transfer	EEMOV	—	1

H8S/2600 CPU: Total 69 types      H8S/2000 CPU: Total 65 types

Notes: B—byte size; W—word size; L—longword size.

1. The MAC, LDMAC, STMAC, and CLRMAC instructions are supported only by the H8S/2600 CPU.
2. POP.W Rn and PUSH.W Rn are identical to MOV.W @SP+, Rn and MOV.W Rn, @-SP. POP.L ERn and PUSH.L ERn are identical to MOV.L @SP+, ERn and MOV.L ERn, @-SP.
3. Bcc is the generic designation of a conditional branch instruction.
4. Only register ER0, ER1, ER4, or ER5 should be used when using the TAS instruction.

## 1.6.2 Instructions and Addressing Modes

Table 1.2 indicates the combinations of instructions and addressing modes that the H8S/2600 CPU and H8S/2000 CPU can use.

**Table 1.2 Combinations of Instructions and Addressing Modes**

Function	Instruction	Addressing Modes														
		#xx	Rn	@ERn	@(d:16,ERn)	@(d:32,ERn)	@-ERn/@ERn+	@aa:8	@aa:16	@aa:24	@aa:32	@(d:8,PC)	@(d:16,PC)	@aa:8	—	
Data transfer	MOV	BWL	BWL	BWL	BWL	BWL	BWL	B	BWL	—	BWL	—	—	—	—	—
	POP, PUSH	—	—	—	—	—	—	—	—	—	—	—	—	—	—	WL
Arithmetic operations	LDM, STM	—	—	—	—	—	—	—	—	—	—	—	—	—	—	L
	MOVEPE, MOVTP	—	—	—	—	—	—	—	B	—	—	—	—	—	—	—
	ADD, CMP	BWL	BWL	—	—	—	—	—	—	—	—	—	—	—	—	—
	SUB	WL	BWL	—	—	—	—	—	—	—	—	—	—	—	—	—
	ADDD, SUBX	B	B	—	—	—	—	—	—	—	—	—	—	—	—	—
	ADDS, SUBS	—	L	—	—	—	—	—	—	—	—	—	—	—	—	—
	INC, DEC	—	BWL	—	—	—	—	—	—	—	—	—	—	—	—	—
	DAA, DAS	—	B	—	—	—	—	—	—	—	—	—	—	—	—	—
	MULXU, DIVXU	—	BW	—	—	—	—	—	—	—	—	—	—	—	—	—
	MULXS, DIVXS	—	BW	—	—	—	—	—	—	—	—	—	—	—	—	—
	NEG	—	BWL	—	—	—	—	—	—	—	—	—	—	—	—	—
	EXTU, EXT	—	WL	—	—	—	—	—	—	—	—	—	—	—	—	—
TAS <sup>*2</sup>	—	—	—	B	—	—	—	—	—	—	—	—	—	—	—	
MAC <sup>*1</sup>	—	—	—	—	—	—	—	—	—	—	—	—	—	—	—	
CLRMAC <sup>*1</sup>	—	—	—	—	—	—	—	—	—	—	—	—	—	—	—	
LDMAC <sup>*1</sup> , STMAC <sup>*1</sup>	—	L	—	—	—	—	—	—	—	—	—	—	—	—	—	



### 1.6.3 Table of Instructions Classified by Function

Table 1.3 summarizes the instructions in each functional category. The notation used in table 1.3 is defined next.

#### Operation Notation

Rd	General register (destination)*
Rs	General register (source)*
Rn	General register*
ERn	General register (32-bit register)
MAC	Multiply-accumulate register (32-bit register)
(EAd)	Destination operand
(EAs)	Source operand
EXR	Extended control register
CCR	Condition-code register
N	N (negative) flag in CCR
Z	Z (zero) flag in CCR
V	V (overflow) flag in CCR
C	C (carry) flag in CCR
PC	Program counter
SP	Stack pointer
#IMM	Immediate data
disp	Displacement
+	Addition
−	Subtraction
×	Multiplication
÷	Division
^	Logical AND
∨	Logical OR
⊕	Logical exclusive OR
→	Move
¬	Logical not (logical complement)
:8/:16/:24/:32	8-, 16-, 24-, or 32-bit length

Note: \* General registers include 8-bit registers (R0H to R7H, R0L to R7L), 16-bit registers (R0 to R7, E0 to E7), and 32-bit registers (ER0 to ER7).

**Table 1.3 Instructions Classified by Function**

<b>Type</b>	<b>Instruction</b>	<b>Size<sup>*1</sup></b>	<b>Function</b>
Data transfer	MOV	B/W/L	(EAs) → Rd, Rs → (EAd) Moves data between two general registers or between a general register and memory, or moves immediate data to a general register.
	MOVFP	B	(EAs) → Rd Moves external memory contents (addressed by @aa:16) to a general register in synchronization with an E clock.
	MOVTP	B	Rs → (EAs) Moves general register contents to an external memory location (addressed by @aa:16) in synchronization with an E clock.
	POP	W/L	@SP+ → Rn Pops a register from the stack. POP.W Rn is identical to MOV.W @SP+, Rn. POP.L ERn is identical to MOV.L @SP+, ERn.
	PUSH	W/L	Rn → @-SP Pushes a register onto the stack. PUSH.W Rn is identical to MOV.W Rn, @-SP. PUSH.L ERn is identical to MOV.L ERn, @-SP.
	LDM	L	@SP+ → Rn (register list) Pops two or more general registers from the stack.
	STM	L	Rn (register list) → @-SP Pushes two or more general registers onto the stack.

Type	Instruction	Size* <sup>1</sup>	Function
Arithmetic operations	ADD	B/W/L	$Rd \pm Rs \rightarrow Rd$ , $Rd \pm \#IMM \rightarrow Rd$
	SUB		Performs addition or subtraction on data in two general registers, or on immediate data and data in a general register. (Immediate byte data cannot be subtracted from byte data in a general register. Use the SUBX or ADD instruction.)
	ADDX	B	$Rd \pm Rs \pm C \rightarrow Rd$ , $Rd \pm \#IMM \pm C \rightarrow Rd$
	SUBX		Performs addition or subtraction with carry or borrow on byte data in two general registers, or on immediate data and data in a general register.
	INC	B/W/L	$Rd \pm 1 \rightarrow Rd$ , $Rd \pm 2 \rightarrow Rd$
	DEC		Increments or decrements a general register by 1 or 2. (Byte operands can be incremented or decremented by 1 only.)
	ADDS	L	$Rd \pm 1 \rightarrow Rd$ , $Rd \pm 2 \rightarrow Rd$ , $Rd \pm 4 \rightarrow Rd$
	SUBS		Adds or subtracts the value 1, 2, or 4 to or from data in a 32-bit register.
	DAA	B	Rd decimal adjust $\rightarrow$ Rd
	DAS		Decimal-adjusts an addition or subtraction result in a general register by referring to the CCR to produce 4-bit BCD data.
	MULXU	B/W	$Rd \times Rs \rightarrow Rd$ Performs unsigned multiplication on data in two general registers: either 8 bits $\times$ 8 bits $\rightarrow$ 16 bits or 16 bits $\times$ 16 bits $\rightarrow$ 32 bits.
	MULXS	B/W	$Rd \times Rs \rightarrow Rd$ Performs signed multiplication on data in two general registers: either 8 bits $\times$ 8 bits $\rightarrow$ 16 bits or 16 bits $\times$ 16 bits $\rightarrow$ 32 bits.
	DIVXU	B/W	$Rd \div Rs \rightarrow Rd$ Performs unsigned division on data in two general registers: either 16 bits $\div$ 8 bits $\rightarrow$ 8-bit quotient and 8-bit remainder or 32 bits $\div$ 16 bits $\rightarrow$ 16-bit quotient and 16-bit remainder.
	DIVXS	B/W	$Rd \div Rs \rightarrow Rd$ Performs signed division on data in two general registers: either 16 bits $\div$ 8 bits $\rightarrow$ 8-bit quotient and 8-bit remainder or 32 bits $\div$ 16 bits $\rightarrow$ 16-bit quotient and 16-bit remainder.

Type	Instruction	Size* <sup>1</sup>	Function
Arithmetic operations	CMP	B/W/L	Rd – Rs, Rd – #IMM Compares data in a general register with data in another general register or with immediate data, and sets CCR bits according to the result.
	NEG	B/W/L	0 – Rd → Rd Takes the two's complement (arithmetic complement) of data in a general register.
	EXTU	W/L	Rd (zero extension) → Rd Extends the lower 8 bits of a 16-bit register to word size, or the lower 16 bits of a 32-bit register to longword size, by padding with zeros on the left.
	EXTS	W/L	Rd (sign extension) → Rd Extends the lower 8 bits of a 16-bit register to word size, or the lower 16 bits of a 32-bit register to longword size, by extending the sign bit.
	TAS	B	@ERd – 0, 1 → (<bit 7> of @ERd)* <sup>2</sup> Tests memory contents, and sets the most significant bit (bit 7) to 1.
	MAC	—	(EAs) × (EAd) + MAC → MAC Performs signed multiplication on memory contents and adds the result to the multiply-accumulate register. The following operations can be performed: 16 bits × 16 bits + 32 bits → 32 bits, saturating 16 bits × 16 bits + 42 bits → 42 bits, non-saturating Supported by H8S/2600 CPU only.
	CLRMAC	—	0 → MAC Clears the multiply-accumulate register to zero. Supported by H8S/2600 CPU only.
	LDMAC STMAC	L	Rs → MAC, MAC → Rd Transfers data between a general register and the multiply-accumulate register. Supported by H8S/2600 CPU only.

Type	Instruction	Size* <sup>1</sup>	Function
Logic operations	AND	B/W/L	$Rd \wedge Rs \rightarrow Rd$ , $Rd \wedge \#IMM \rightarrow Rd$ Performs a logical AND operation on a general register and another general register or immediate data.
	OR	B/W/L	$Rd \vee Rs \rightarrow Rd$ , $Rd \vee \#IMM \rightarrow Rd$ Performs a logical OR operation on a general register and another general register or immediate data.
	XOR	B/W/L	$Rd \oplus Rs \rightarrow Rd$ , $Rd \oplus \#IMM \rightarrow Rd$ Performs a logical exclusive OR operation on a general register and another general register or immediate data.
	NOT	B/W/L	$\neg (Rd) \rightarrow (Rd)$ Takes the one's complement of general register contents.
Shift operations	SHAL SHAR	B/W/L	$Rd \text{ (shift)} \rightarrow Rd$ Performs an arithmetic shift on general register contents. 1-bit or 2-bit shift is possible.
	SHLL SHLR	B/W/L	$Rd \text{ (shift)} \rightarrow Rd$ Performs a logical shift on general register contents. 1-bit or 2-bit shift is possible.
	ROTL ROTR	B/W/L	$Rd \text{ (rotate)} \rightarrow Rd$ Rotates general register contents. 1-bit or 2-bit rotation is possible.
	ROTXL ROTXR	B/W/L	$Rd \text{ (rotate)} \rightarrow Rd$ Rotates general register contents through the carry bit. 1-bit or 2-bit rotation is possible.



Type	Instruction	Size* <sup>1</sup>	Function
Bit-manipulation instructions	BSET	B	$1 \rightarrow (\text{<bit-No.> of <EAd>})$ Sets a specified bit in a general register or memory operand to 1. The bit number is specified by 3-bit immediate data or the lower three bits of a general register.
	BCLR	B	$0 \rightarrow (\text{<bit-No.> of <EAd>})$ Clears a specified bit in a general register or memory operand to 0. The bit number is specified by 3-bit immediate data or the lower three bits of a general register.
	BNOT	B	$\neg (\text{<bit-No.> of <EAd>}) \rightarrow (\text{<bit-No.> of <EAd>})$ Inverts a specified bit in a general register or memory operand. The bit number is specified by 3-bit immediate data or the lower three bits of a general register.
	BTST	B	$\neg (\text{<bit-No.> of <EAd>}) \rightarrow Z$ Tests a specified bit in a general register or memory operand and sets or clears the Z flag accordingly. The bit number is specified by 3-bit immediate data or the lower three bits of a general register.
	BAND	B	$C \wedge (\text{<bit-No.> of <EAd>}) \rightarrow C$ ANDs the carry flag with a specified bit in a general register or memory operand and stores the result in the carry flag.
	BIAND	B	$C \wedge \neg (\text{<bit-No.> of <EAd>}) \rightarrow C$ ANDs the carry flag with the inverse of a specified bit in a general register or memory operand and stores the result in the carry flag. The bit number is specified by 3-bit immediate data.
	BOR	B	$C \vee (\text{<bit-No.> of <EAd>}) \rightarrow C$ ORs the carry flag with a specified bit in a general register or memory operand and stores the result in the carry flag.
	BIOR	B	$C \vee \neg (\text{<bit-No.> of <EAd>}) \rightarrow C$ ORs the carry flag with the inverse of a specified bit in a general register or memory operand and stores the result in the carry flag. The bit number is specified by 3-bit immediate data.

Type	Instruction	Size* <sup>1</sup>	Function
Bit-manipulation instructions	BXOR	B	$C \oplus (\text{<bit-No.> of <EAd>}) \rightarrow C$ Exclusive-ORs the carry flag with a specified bit in a general register or memory operand and stores the result in the carry flag.
	BIXOR	B	$C \oplus \neg (\text{<bit-No.> of <EAd>}) \rightarrow C$ Exclusive-ORs the carry flag with the inverse of a specified bit in a general register or memory operand and stores the result in the carry flag. The bit number is specified by 3-bit immediate data.
	BLD	B	$(\text{<bit-No.> of <EAd>}) \rightarrow C$ Transfers a specified bit in a general register or memory operand to the carry flag.
	BILD	B	$\neg (\text{<bit-No.> of <EAd>}) \rightarrow C$ Transfers the inverse of a specified bit in a general register or memory operand to the carry flag. The bit number is specified by 3-bit immediate data.
	BST	B	$C \rightarrow (\text{<bit-No.> of <EAd>})$ Transfers the carry flag value to a specified bit in a general register or memory operand.
	BIST	B	$\neg C \rightarrow (\text{<bit-No.> of <EAd>})$ Transfers the inverse of the carry flag value to a specified bit in a general register or memory operand. The bit number is specified by 3-bit immediate data.

Type	Instruction	Size* <sup>1</sup>	Function																																																			
Branch instructions	Bcc	—	Branches to a specified address if a specified condition is true. The branching conditions are listed below.																																																			
			<table border="1"> <thead> <tr> <th>Mnemonic</th> <th>Description</th> <th>Condition</th> </tr> </thead> <tbody> <tr> <td>BRA(BT)</td> <td>Always (true)</td> <td>Always</td> </tr> <tr> <td>BRN(BF)</td> <td>Never (false)</td> <td>Never</td> </tr> <tr> <td>BHI</td> <td>High</td> <td><math>C \vee Z = 0</math></td> </tr> <tr> <td>BLS</td> <td>Low or same</td> <td><math>C \vee Z = 1</math></td> </tr> <tr> <td>BCC(BHS)</td> <td>Carry clear (high or same)</td> <td><math>C = 0</math></td> </tr> <tr> <td>BCS(BLO)</td> <td>Carry set (low)</td> <td><math>C = 1</math></td> </tr> <tr> <td>BNE</td> <td>Not equal</td> <td><math>Z = 0</math></td> </tr> <tr> <td>BEQ</td> <td>Equal</td> <td><math>Z = 1</math></td> </tr> <tr> <td>BVC</td> <td>Overflow clear</td> <td><math>V = 0</math></td> </tr> <tr> <td>BVS</td> <td>Overflow set</td> <td><math>V = 1</math></td> </tr> <tr> <td>BPL</td> <td>Plus</td> <td><math>N = 0</math></td> </tr> <tr> <td>BMI</td> <td>Minus</td> <td><math>N = 1</math></td> </tr> <tr> <td>BGE</td> <td>Greater or equal</td> <td><math>N \oplus V = 0</math></td> </tr> <tr> <td>BLT</td> <td>Less than</td> <td><math>N \oplus V = 1</math></td> </tr> <tr> <td>BGT</td> <td>Greater than</td> <td><math>Z \vee (N \oplus V) = 0</math></td> </tr> <tr> <td>BLE</td> <td>Less or equal</td> <td><math>Z \vee (N \oplus V) = 1</math></td> </tr> </tbody> </table>	Mnemonic	Description	Condition	BRA(BT)	Always (true)	Always	BRN(BF)	Never (false)	Never	BHI	High	$C \vee Z = 0$	BLS	Low or same	$C \vee Z = 1$	BCC(BHS)	Carry clear (high or same)	$C = 0$	BCS(BLO)	Carry set (low)	$C = 1$	BNE	Not equal	$Z = 0$	BEQ	Equal	$Z = 1$	BVC	Overflow clear	$V = 0$	BVS	Overflow set	$V = 1$	BPL	Plus	$N = 0$	BMI	Minus	$N = 1$	BGE	Greater or equal	$N \oplus V = 0$	BLT	Less than	$N \oplus V = 1$	BGT	Greater than	$Z \vee (N \oplus V) = 0$	BLE	Less or equal	$Z \vee (N \oplus V) = 1$
			Mnemonic	Description	Condition																																																	
			BRA(BT)	Always (true)	Always																																																	
			BRN(BF)	Never (false)	Never																																																	
			BHI	High	$C \vee Z = 0$																																																	
			BLS	Low or same	$C \vee Z = 1$																																																	
			BCC(BHS)	Carry clear (high or same)	$C = 0$																																																	
			BCS(BLO)	Carry set (low)	$C = 1$																																																	
			BNE	Not equal	$Z = 0$																																																	
			BEQ	Equal	$Z = 1$																																																	
			BVC	Overflow clear	$V = 0$																																																	
			BVS	Overflow set	$V = 1$																																																	
			BPL	Plus	$N = 0$																																																	
			BMI	Minus	$N = 1$																																																	
			BGE	Greater or equal	$N \oplus V = 0$																																																	
			BLT	Less than	$N \oplus V = 1$																																																	
			BGT	Greater than	$Z \vee (N \oplus V) = 0$																																																	
			BLE	Less or equal	$Z \vee (N \oplus V) = 1$																																																	
			JMP	—	Branches unconditionally to a specified address.																																																	
BSR	—	Branches to a subroutine at a specified address.																																																				
JSR	—	Branches to a subroutine at a specified address.																																																				
RTS	—	Returns from a subroutine																																																				

Type	Instruction	Size* <sup>1</sup>	Function
System control instructions	TRAPA	—	Starts trap-instruction exception handling.
	RTE	—	Returns from an exception-handling routine.
	SLEEP	—	Causes a transition to a power-down state.
	LDC	B/W	(EAs) → CCR, (EAs) → EXR Moves the source operand contents or immediate data to CCR or EXR. Although CCR and EXR are 8-bit registers, word-size transfers are performed between them and memory. The upper 8 bits are valid.
	STC	B/W	CCR → (EAd), EXR → (EAd) Transfers CCR or EXR contents to a general register or memory. Although CCR and EXR are 8-bit registers, word-size transfers are performed between them and memory. The upper 8 bits are valid.
	ANDC	B	CCR ∧ #IMM → CCR, EXR ∧ #IMM → EXR Logically ANDs the CCR or EXR contents with immediate data.
	ORC	B	CCR ∨ #IMM → CCR, EXR ∨ #IMM → EXR Logically ORs the CCR or EXR contents with immediate data.
	XORC	B	CCR ⊕ #IMM → CCR, EXR ⊕ #IMM → EXR Logically exclusive-ORs the CCR or EXR contents with immediate data.
NOP	—	PC + 2 → PC Only increments the program counter.	

Type	Instruction	Size* <sup>1</sup>	Function
Block data transfer instruction	EEPMOV.B	—	if R4L $\neq$ 0 then Repeat @ER5+ $\rightarrow$ @ER6+ R4L - 1 $\rightarrow$ R4L Until R4L = 0 else next;
	EEPMOV.W	—	if R4 $\neq$ 0 then Repeat @ER5+ $\rightarrow$ @ER6+ R4 - 1 $\rightarrow$ R4 Until R4 = 0 else next;
			Transfers a data block according to parameters set in general registers R4L or R4, ER5, and ER6.  R4L or R4: size of block (bytes) ER5: starting source address ER6: starting destination address  Execution of the next instruction begins as soon as the transfer is completed.

Notes: 1. Size refers to the operand size.

B: Byte

W: Word

L: Longword

2. Only register ER0, ER1, ER4, or ER5 should be used when using the TAS instruction.

## 1.6.4 Basic Instruction Formats

The H8S/2600 or H8S/2000 instructions consist of 2-byte (1-word) units. An instruction consists of an operation field (op field), a register field (r field), an effective address extension (EA field), and a condition field (cc).

**Operation Field:** Indicates the function of the instruction, the addressing mode, and the operation to be carried out on the operand. The operation field always includes the first four bits of the instruction. Some instructions have two operation fields.

**Register Field:** Specifies a general register. Address registers are specified by 3 bits, data registers by 3 bits or 4 bits. Some instructions have two register fields. Some have no register field.

**Effective Address Extension:** Eight, 16, or 32 bits specifying immediate data, an absolute address, or a displacement.

**Condition Field:** Specifies the branching condition of Bcc instructions.

Figure 1.12 shows examples of instruction formats.

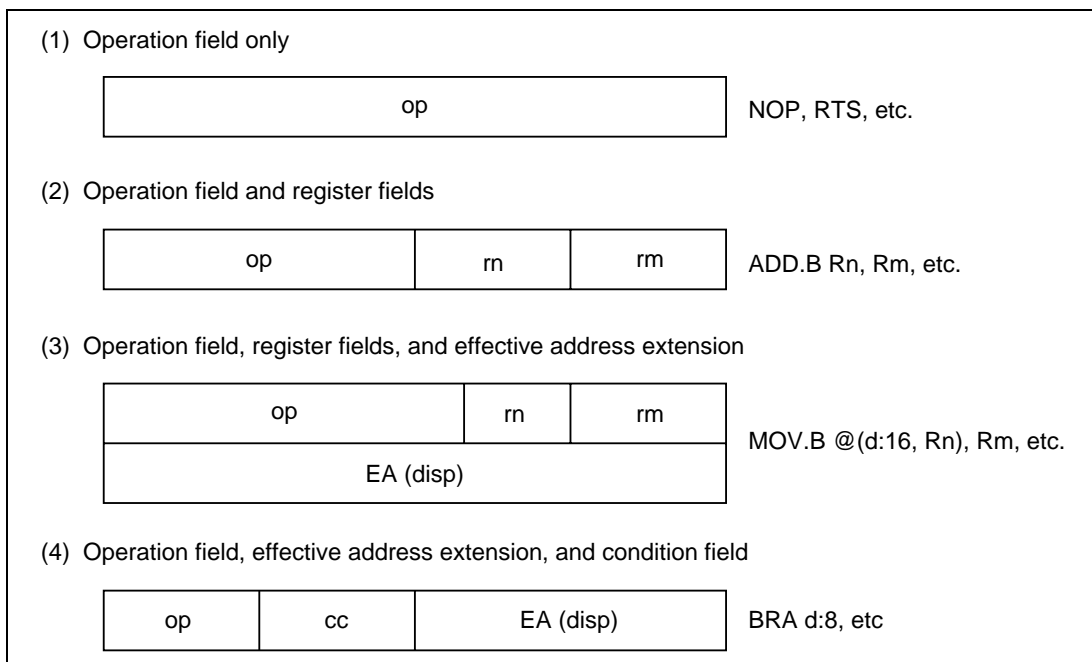

**Figure 1.12 Instruction Formats**

## 1.7 Addressing Modes and Effective Address Calculation

### (1) Addressing Modes

The CPUs support the eight addressing modes listed in table 1.4. Each instruction uses a subset of these addressing modes. Arithmetic and logic instructions can use the register direct and immediate modes. Data transfer instructions can use all addressing modes except program-counter relative and memory indirect. Bit manipulation instructions use register direct, register indirect, or absolute addressing mode to specify an operand, and register direct (BSET, BCLR, BNOT, and BTST instructions) or immediate (3-bit) addressing mode to specify a bit number in the operand.

**Table 1.4 Addressing Modes**

No.	Addressing Mode	Symbol
1	Register direct	Rn
2	Register indirect	@ERn
3	Register indirect with displacement	@(d:16,ERn)/@(d:32,ERn)
4	Register indirect with post-increment	@ERn+
	Register indirect with pre-decrement	@-ERn
5	Absolute address	@aa:8/@aa:16/@aa:24/@aa:32
6	Immediate	#xx:8/#xx:16/#xx:32
7	Program-counter relative	@(d:8,PC)/@(d:16,PC)
8	Memory indirect	@@aa:8

**1. Register Direct—Rn:** The register field of the instruction specifies an 8-, 16-, or 32-bit general register containing the operand. R0H to R7H and R0L to R7L can be specified as 8-bit registers. R0 to R7 and E0 to E7 can be specified as 16-bit registers. ER0 to ER7 can be specified as 32-bit registers.

**2. Register Indirect—@ERn:** The register field of the instruction code specifies an address register (ERn) which contains the address of the operand in memory. If the address is a program instruction address, the lower 24 bits are valid and the upper 8 bits are all assumed to be 0 (H'00).

**3. Register Indirect with Displacement—@(d:16, ERn) or @(d:32, ERn):** A 16-bit or 32-bit displacement contained in the instruction is added to an address register (ERn) specified by the register field of the instruction, and the sum gives the address of a memory operand. A 16-bit displacement is sign-extended when added.

#### 4. Register Indirect with Post-Increment or Pre-Decrement—@ERn+ or @-ERn:

- Register indirect with post-increment—@ERn+

The register field of the instruction code specifies an address register (ERn) which contains the address of a memory operand. After the operand is accessed, 1, 2, or 4 is added to the address register contents and the sum is stored in the address register. The value added is 1 for byte access, 2 for word access, or 4 for longword access. For word or longword access, the register value should be even.

- Register indirect with pre-decrement—@-ERn

The value 1, 2, or 4 is subtracted from an address register (ERn) specified by the register field in the instruction code, and the result becomes the address of a memory operand. The result is also stored in the address register. The value subtracted is 1 for byte access, 2 for word access, or 4 for longword access. For word or longword access, the register value should be even.

**5. Absolute Address—@aa:8, @aa:16, @aa:24, or @aa:32:** The instruction code contains the absolute address of a memory operand. The absolute address may be 8 bits long (@aa:8), 16 bits long (@aa:16), 24 bits long (@aa:24), or 32 bits long (@aa:32).

To access data, the absolute address should be 8 bits (@aa:8), 16 bits (@aa:16), or 32 bits (@aa:32) long. For an 8-bit absolute address, the upper 24 bits are all assumed to be 1 (H'FFFFFF). For a 16-bit absolute address the upper 16 bits are a sign extension. A 32-bit absolute address can access the entire address space.

A 24-bit absolute address (@aa:24) indicates the address of a program instruction. The upper 8 bits are all assumed to be 0 (H'00).

Table 1.5 indicates the accessible absolute address ranges.

**Table 1.5 Absolute Address Access Ranges**

<b>Absolute Address</b>		<b>Normal Mode</b>	<b>Advanced Mode</b>
Data address	8 bits (@aa:8)	H'FF00 to H'FFFF	H'FFFFFFF00 to H'FFFFFFF
	16 bits (@aa:16)	H'0000 to H'FFFF	H'00000000 to H'00007FFF, H'FFFF8000 to H'FFFFFFF
	32 bits (@aa:32)		H'00000000 to H'FFFFFFF
Program instruction address	24 bits (@aa:24)		H'00000000 to H'00FFFFFF

For further details on the accessible range, refer to the relevant microcontroller hardware manual.



**6. Immediate**—**#xx:8, #xx:16, or #xx:32**: The instruction contains 8-bit (#xx:8), 16-bit (#xx:16), or 32-bit (#xx:32) immediate data as an operand.

The ADDS, SUBS, INC, and DEC instructions contain immediate data implicitly. Some bit manipulation instructions contain 3-bit immediate data in the instruction code, specifying a bit number. The TRAPA instruction contains 2-bit immediate data in its instruction code, specifying a vector address.

**7. Program-Counter Relative**—**@(d:8, PC) or @(d:16, PC)**: This mode is used in the Bcc and BSR instructions. An 8-bit or 16-bit displacement contained in the instruction is sign-extended and added to the 24-bit PC contents to generate a branch address. Only the lower 24 bits of this branch address are valid; the upper 8 bits are all assumed to be 0 (H'00). The PC value to which the displacement is added is the address of the first byte of the next instruction, so the possible branching range is -126 to +128 bytes (-63 to +64 words) or -32766 to +32768 bytes (-16383 to +16384 words) from the branch instruction. The resulting value should be an even number.

**8. Memory Indirect**—**@@aa:8**: This mode can be used by the JMP and JSR instructions. The second byte of the instruction specifies a memory operand by an 8-bit absolute address. This memory operand contains a branch address. The upper bits of the absolute address are all assumed to be 0, so the address range is 0 to 255 (H'0000 to H'00FF in normal mode, H'00000000 to H'000000FF in advanced mode). In normal mode the memory operand is a word operand and the branch address is 16 bits long. In advanced mode the memory operand is a longword operand, the first byte of which is assumed to be all 0 (H'00).

Note that the first part of the address range is also the exception vector area. For further details refer to the relevant microcontroller hardware manual.

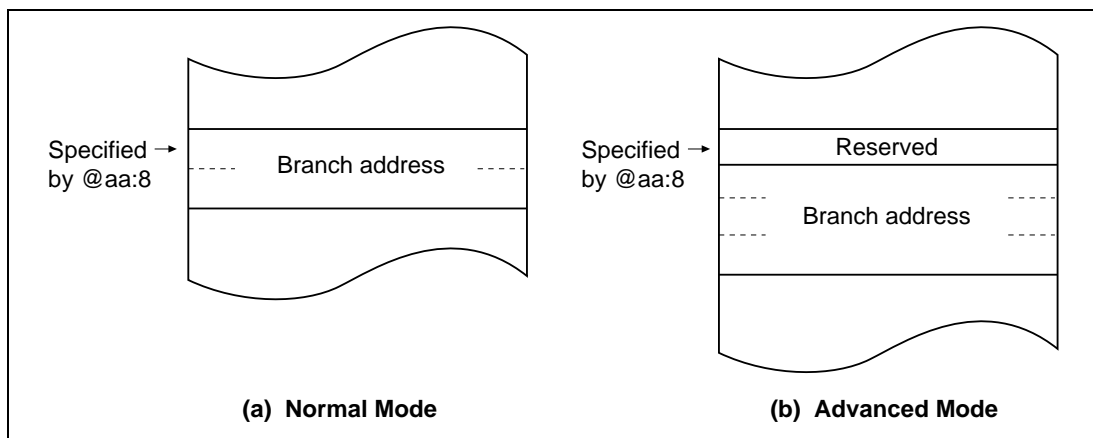

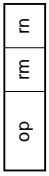

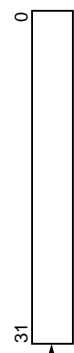
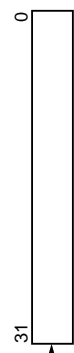

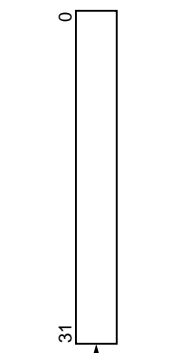
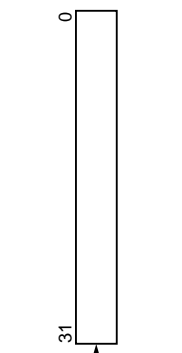

**Figure 1.13 Branch Address Specification in Memory Indirect Mode**





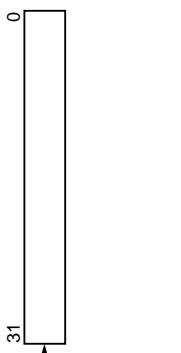
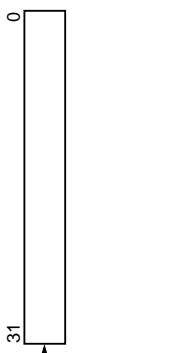

If an odd address is specified in word or longword memory access, or as a branch address, the least significant bit is regarded as 0, causing data to be accessed or an instruction code to be fetched at the address preceding the specified address. (For further information, see section 1.5.2, Memory Data Formats.)

## **(2) Effective Address Calculation**

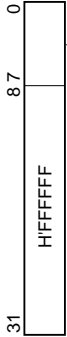
Table 1.6 indicates how effective addresses are calculated in each addressing mode. In normal mode the upper 8 bits of the effective address are ignored in order to generate a 16-bit address.

**Table 1.6 Effective Address Calculation**

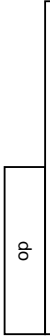
No.	Addressing Mode and Instruction Format	Effective Address Calculation	Effective Address (EA)								
1	Register direct (Rn) 		Operand is general register contents.								
2	Register indirect (@ERn) 										
3	Register indirect with displacement @(d:16, ERn) or @(d:32, ERn) 										
4	Register indirect with post-increment or pre-decrement • Register indirect with post-increment @ERn+  • Register indirect with pre-decrement @--ERn 	 <table border="1" data-bbox="981 630 1089 869"> <thead> <tr> <th>Operand Size</th> <th>Value added</th> </tr> </thead> <tbody> <tr> <td>Byte</td> <td>1</td> </tr> <tr> <td>Word</td> <td>2</td> </tr> <tr> <td>Longword</td> <td>4</td> </tr> </tbody> </table>	Operand Size	Value added	Byte	1	Word	2	Longword	4	
Operand Size	Value added										
Byte	1										
Word	2										
Longword	4										

No.	Addressing Mode and Instruction Format	Effective Address Calculation	Effective Address (EA)
5	Absolute address @aa:8 		
	@aa:16 		
	@aa:24 		
	@aa:32 		
6	Immediate #xx:8/#xx:16/#xx:32 		Operand is immediate data.

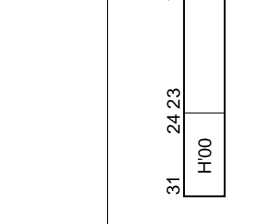
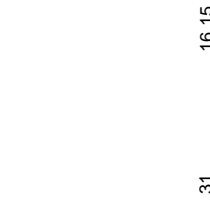
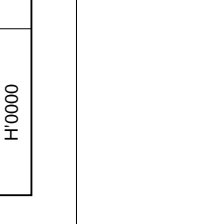
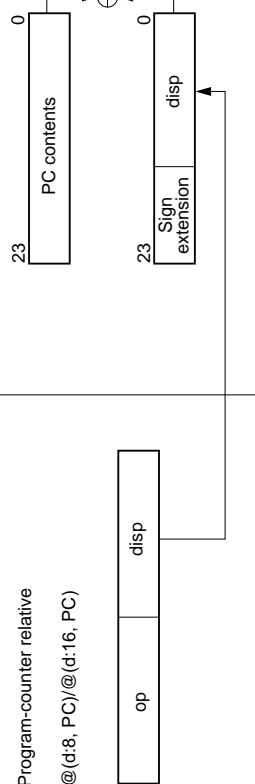
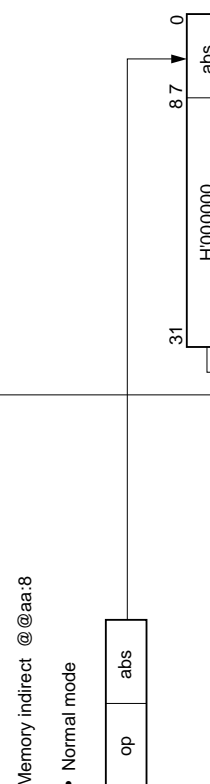
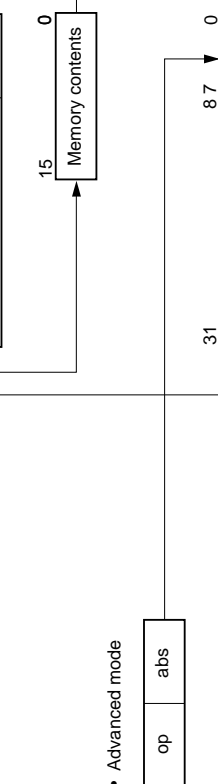
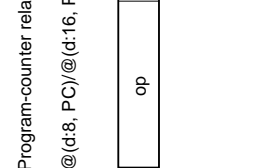
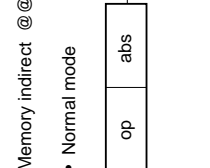
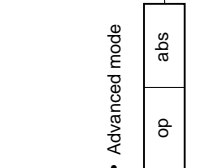
No.	Addressing Mode and Instruction Format	Effective Address Calculation	Effective Address (EA)
7	<p>Program-counter relative @ (d:8, PC) / @ (d:16, PC)</p> 		
8	<p>Memory indirect @aa:8</p> <ul style="list-style-type: none"> <li>• Normal mode</li> </ul> 		
	<ul style="list-style-type: none"> <li>• Advanced mode</li> </ul> 		



# Section 2 Instruction Descriptions

## 2.1 Tables and Symbols

This section explains how to read the tables in section 2.2, describing each instruction. Note that the descriptions of some instructions extend over more than one page.

[1] <b>Mnemonic (Full Name)</b>	[2] <b>Type</b>
[3] <b>Operation</b>	[6] <b>Condition Code</b>
[4] <b>Assembly-Language Format</b>	
[5] <b>Operand Size</b>	
[7] <b>Description</b>	
[8] <b>Available Registers</b>	
[9] <b>Operand Format and Number of States Required for Execution</b>	
[10] <b>Notes</b>	

- [1] **Mnemonic (Full Name):** Gives the full and mnemonic names of the instruction.
- [2] **Type:** Indicates the type of instruction.
- [3] **Operation:** Describes the instruction in symbolic notation. (See section 2.1.2, Operation.)
- [4] **Assembly-Language Format:** Indicates the assembly-language format of the instruction. (See section 2.1.1, Assembler Format.)
- [5] **Operand Size:** Indicates the available operand sizes.
- [6] **Condition Code:** Indicates the effect of instruction execution on the flag bits in the CCR. (See section 2.1.3, Condition Code.)
- [7] **Description:** Describes the operation of the instruction in detail.
- [8] **Available Registers:** Indicates which registers can be specified in the register field of the instruction.
- [9] **Operand Format and Number of States Required for Execution:** Shows the addressing modes and instruction format together with the number of states required for execution.
- [10] **Notes:** Gives notes concerning execution of the instruction.

## 2.1.1 Assembly-Language Format

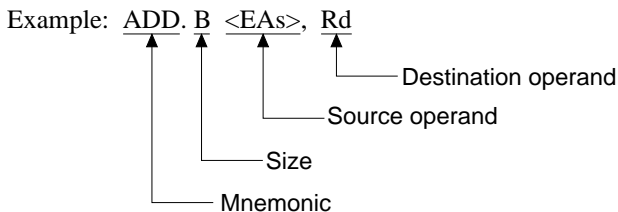

The operand size is byte (B), word (W), or longword (L). Some instructions are restricted to a limited set of operand sizes.

The symbol <EA> indicates that two or more addressing modes can be used. The H8S/2600 CPU supports the eight addressing modes listed next. Effective address calculation is described in section 1.7, Addressing Modes and Effective Address Calculation.

Symbol	Addressing Mode
Rn	Register direct
@ERn	Register indirect
@(d:16, ERn)/@(d:32, ERn)	Register indirect with displacement (16-bit or 32-bit)
@ERn+/@-ERn	Register indirect with post-increment or pre-decrement
@aa:8/@aa:16/@aa:24/@aa:32	Absolute address (8-bit, 16-bit, 24-bit, or 32-bit)
#xx:8/#xx:16/#xx:32	Immediate (8-bit, 16-bit, or 32-bit)
@(d:8, PC)/@(d:16, PC)	Program-counter relative (8-bit or 16-bit)
@@aa:8	Memory indirect

The suffixes :8, :16, :24, and :32 may be omitted. In particular, if the :8, :16, :24, or :32 designation is omitted in an absolute address or displacement, the assembler will optimize the length according to the value range. For details, refer to the H8S, H8/300 Series cross assembler user's manual.

Note: “:2” and “:3” in “#xx (:2)” and “#xx (:3)” indicate the specifiable bit length. Do not include (:2) or (:3) in the assembler notation.

Example: TRAPA #3



## 2.1.2 Operation

The symbols used in the operation descriptions are defined as follows.

Rd	General register (destination)*
Rs	General register (source)*
Rn	General register*
ERn	General register (32-bit register)
MAC	Multiply-accumulate register (32-bit register)
(EAd)	Destination operand
(EAs)	Source operand
EXR	Extended control register
CCR	Condition-code register
N	N (negative) flag in CCR
Z	Z (zero) flag in CCR
V	V (overflow) flag in CCR
C	C (carry) flag in CCR
PC	Program counter
SP	Stack pointer
#IMM	Immediate data
disp	Displacement
+	Add
−	Subtract
×	Multiply
÷	Divide
^	Logical AND
∨	Logical OR
⊕	Logical exclusive OR
→	Transfer from the operand on the left to the operand on the right, or transition from the state on the left to the state on the right
¬	Logical NOT (logical complement)
( ) < >	Contents of effective address of the operand
:8/:16/ :24/:32	8-, 16-, 24-, or 32-bit length

Note: \*General registers include 8-bit registers (R0H to R7H and R0L to R7L), 16-bit registers (R0 to R7 and E0 to E7), and 32-bit registers (ER0 to ER7).

### 2.1.3 Condition Code

The symbols used in the condition-code description are defined as follows.

Symbol	Meaning
↕	Changes according to the result of instruction execution
*	Undetermined (no guaranteed value)
0	Always cleared to 0
1	Always set to 1
—	Not affected by execution of the instruction
Δ	Varies depending on conditions; see the notes

For details on changes of the condition code, see section 2.8, Condition Code Modification.

### 2.1.4 Instruction Format

The symbols used in the instruction format descriptions are listed below.

Symbol	Meaning
IMM	Immediate data (2, 3, 8, 16, or 32 bits)
abs	Absolute address (8, 16, 24, or 32 bits)
disp	Displacement (8, 16, or 32 bits)
rs, rd, rn	Register field (4 bits). The symbols rs, rd, and rn correspond to operand symbols Rs, Rd, and Rn.
ers, erd, ern	Register field (3 bits). The symbols ers, erd, and ern correspond to operand symbols ERs, ERd, and ERn.

## 2.1.5 Register Specification

**Address Register Specification:** When a general register is used as an address register [ $@ERn$ ,  $@(d:16, ERn)$ ,  $@(d:32, ERn)$ ,  $@ERn+$ , or  $@-ERn$ ], the register is specified by a 3-bit register field (ers or erd).

**Data Register Specification:** A general register can be used as a 32-bit, 16-bit, or 8-bit data register.

When used as a 32-bit register, it is specified by a 3-bit register field (ers, erd, or ern).

When used as a 16-bit register, it is specified by a 4-bit register field (rs, rd, or rn). The lower 3 bits specify the register number. The upper bit is set to 1 to specify an extended register (En) or cleared to 0 to specify a general register (Rn).

When used as an 8-bit register, it is specified by a 4-bit register field (rs, rd, or rn). The lower 3 bits specify the register number. The upper bit is set to 1 to specify a low register (RnL) or cleared to 0 to specify a high register (RnH). This is shown next.

Address Register 32-Bit Register		16-Bit Register		8-Bit Register	
Register Field	General Register	Register Field	General Register	Register Field	General Register
000	ER0	0000	R0	0000	R0H
001	ER1	0001	R1	0001	R1H
.	.	.	.	.	.
.	.	.	.	.	.
111	ER7	0111	R7	0111	R7H
		1000	E0	1000	R0L
		1001	E1	1001	R1L
		.	.	.	.
		.	.	.	.
		1111	E7	1111	R7L

## 2.1.6 Bit Data Access in Bit Manipulation Instructions

Bit data is accessed as the n-th bit ( $n = 0, 1, 2, 3, \dots, 7$ ) of a byte operand in a general register or memory. The bit number is given by 3-bit immediate data, or by the lower 3 bits of a general register value.

Example 1: To set bit 3 in R2H to 1

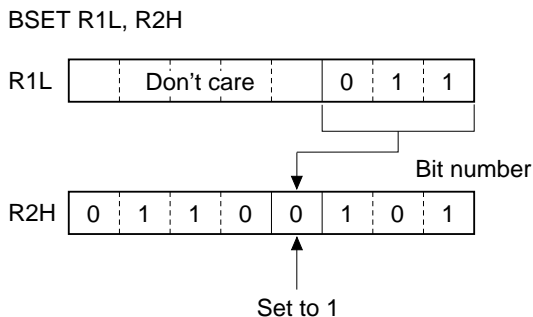

Example 2: To load bit 5 at address H'FFFF02 into the bit accumulator

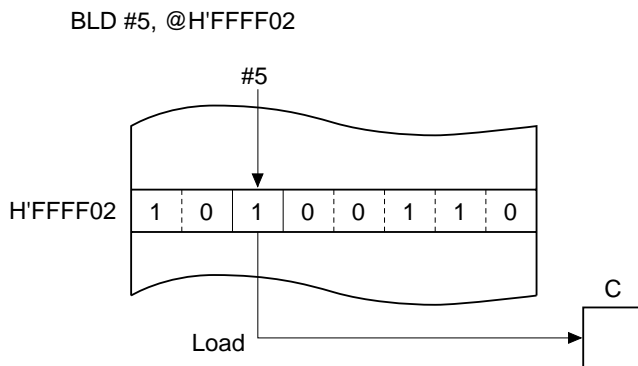

The operand size and addressing mode are as indicated for register or memory operand data.

## 2.2 Instruction Descriptions

The instructions are described starting in section 2.2.1.

## 2.2.1 (1) ADD (B)

### ADD (ADD Binary)

### Add Binary

#### Operation

Rd + (EAs) → Rd

#### Condition Code

I	UI	H	U	N	Z	V	C
—	—	↕	—	↕	↕	↕	↕

#### Assembly-Language Format

ADD.B <EAs>, Rd

- H: Set to 1 if there is a carry at bit 3; otherwise cleared to 0.
- N: Set to 1 if the result is negative; otherwise cleared to 0.
- Z: Set to 1 if the result is zero; otherwise cleared to 0.
- V: Set to 1 if an overflow occurs; otherwise cleared to 0.
- C: Set to 1 if there is a carry at bit 7; otherwise cleared to 0.

#### Operand Size

Byte

#### Description

This instruction adds the source operand to the contents of an 8-bit register Rd (destination operand) and stores the result in the 8-bit register Rd.

#### Available Registers

Rd: R0L to R7L, R0H to R7H

Rs: R0L to R7L, R0H to R7H

#### Operand Format and Number of States Required for Execution

Addressing Mode	Mnemonic	Operands	Instruction Format				No. of States
			1st byte	2nd byte	3rd byte	4th byte	
Immediate	ADD.B	#xx:8, Rd	8	rd	IMM		1
Register direct	ADD.B	Rs, Rd	0	8	rs	rd	1

#### Notes

## 2.2.1 (2) ADD (W)

### ADD (ADD Binary)

### Add Binary

#### Operation

Rd + (EAs) → Rd

#### Condition Code

I	UI	H	U	N	Z	V	C
—	—	↕	—	↕	↕	↕	↕

#### Assembly-Language Format

ADD.W <EAs>, Rd

#### Operand Size

Word

- H: Set to 1 if there is a carry at bit 11; otherwise cleared to 0.
- N: Set to 1 if the result is negative; otherwise cleared to 0.
- Z: Set to 1 if the result is zero; otherwise cleared to 0.
- V: Set to 1 if an overflow occurs; otherwise cleared to 0.
- C: Set to 1 if there is a carry at bit 15; otherwise cleared to 0.

#### Description

This instruction adds the source operand to the contents of a 16-bit register Rd (destination operand) and stores the result in the 16-bit register Rd.

#### Available Registers

Rd: R0 to R7, E0 to E7

Rs: R0 to R7, E0 to E7

#### Operand Format and Number of States Required for Execution

Addressing Mode	Mnemonic	Operands	Instruction Format				No. of States	
			1st byte	2nd byte	3rd byte	4th byte		
Immediate	ADD.W	#xx:16, Rd	7	9	1	rd	IMM	2
Register direct	ADD.W	Rs, Rd	0	9	rs	rd		1

#### Notes

## 2.2.1 (3) ADD (L)

### ADD (ADD Binary)

### Add Binary

#### Operation

ERd + (EAs) → ERd

#### Condition Code

I	UI	H	U	N	Z	V	C
—	—	↕	—	↕	↕	↕	↕

#### Assembly-Language Format

ADD.L <EAs>, ERd

#### Operand Size

Longword

- H: Set to 1 if there is a carry at bit 27; otherwise cleared to 0.
- N: Set to 1 if the result is negative; otherwise cleared to 0.
- Z: Set to 1 if the result is zero; otherwise cleared to 0.
- V: Set to 1 if an overflow occurs; otherwise cleared to 0.
- C: Set to 1 if there is a carry at bit 31; otherwise cleared to 0.

#### Description

This instruction adds the source operand to the contents of a 32-bit register ERd (destination operand) and stores the result in the 32-bit register ERd.

#### Available Registers

ERd: ER0 to ER7

ERs: ER0 to ER7

#### Operand Format and Number of States Required for Execution

Addressing Mode	Mnemonic	Operands	Instruction Format						No. of States	
			1st byte		2nd byte		3rd byte	4th byte		5th byte
Immediate	ADD.L	#xx:32, ERd	7	A	1	0:erd	IMM			3
Register direct	ADD.L	ERs, ERd	0	A	1:ers	0:erd				1

#### Notes



## 2.2.2 ADDS

### ADDS (ADD with Sign extension)

### Add Binary Address Data

#### Operation

Rd + 1 → ERd

Rd + 2 → ERd

Rd + 4 → ERd

#### Condition Code

I	UI	H	U	N	Z	V	C
—	—	—	—	—	—	—	—

#### Assembly-Language Format

ADDS #1, ERd

ADDS #2, ERd

ADDS #4, ERd

H: Previous value remains unchanged.

N: Previous value remains unchanged.

Z: Previous value remains unchanged.

V: Previous value remains unchanged.

C: Previous value remains unchanged.

#### Operand Size

Longword

#### Description

This instruction adds the immediate value 1, 2, or 4 to the contents of a 32-bit register ERd (destination operand). Unlike the ADD instruction, it does not affect the condition code flags.

#### Available Registers

ERd: ER0 to ER7

#### Operand Format and Number of States Required for Execution

Addressing Mode	Mnemonic	Operands	Instruction Format				No. of States
			1st byte	2nd byte	3rd byte	4th byte	
Register direct	ADDS	#1, ERd	0 B	0:0:erd			1
Register direct	ADDS	#2, ERd	0 B	8:0:erd			1
Register direct	ADDS	#4, ERd	0 B	9:0:erd			1

#### Notes

## 2.2.3 ADDX

### ADDX (ADD with eXtend carry)

Add with Carry

#### Operation

$Rd + (EAs) + C \rightarrow Rd$

#### Condition Code

I	UI	H	U	N	Z	V	C
—	—	↕	—	↕	↕	↕	↕

#### Assembly-Language Format

ADDX <EAs>, Rd

#### Operand Size

Byte

- H: Set to 1 if there is a carry at bit 3; otherwise cleared to 0.
- N: Set to 1 if the result is negative; otherwise cleared to 0.
- Z: Set to 1 if the result is zero; otherwise cleared to 0.
- V: Set to 1 if an overflow occurs; otherwise cleared to 0.
- C: Set to 1 if there is a carry at bit 7; otherwise cleared to 0.

#### Description

This instruction adds the source operand and carry flag to the contents of an 8-bit register Rd (destination operand) and stores the result in the 8-bit register Rd.

#### Available Registers

Rd: R0L to R7L, R0H to R7H

Rs: R0L to R7L, R0H to R7H

#### Operand Format and Number of States Required for Execution

Addressing Mode	Mnemonic	Operands	Instruction Format				No. of States
			1st byte	2nd byte	3rd byte	4th byte	
Immediate	ADDX	#xx:8, Rd	9	rd	IMM		1
Register direct	ADDX	Rs, Rd	0	E	rs	rd	1

#### Notes

## 2.2.4 (1) AND (B)

### AND (AND logical)

### Logical AND

#### Operation

Rd  $\wedge$  (EAs)  $\rightarrow$  Rd

#### Condition Code

I	UI	H	U	N	Z	V	C
—	—	—	—	↕	↕	0	—

#### Assembly-Language Format

AND .B <EAs>, Rd

- H: Previous value remains unchanged.  
N: Set to 1 if the result is negative; otherwise cleared to 0.  
Z: Set to 1 if the result is zero; otherwise cleared to 0.  
V: Always cleared to 0.  
C: Previous value remains unchanged.

#### Operand Size

Byte

#### Description

This instruction ANDs the source operand with the contents of an 8-bit register Rd (destination operand) and stores the result in the 8-bit register Rd.

#### Available Registers

Rd: R0L to R7L, R0H to R7H

Rs: R0L to R7L, R0H to R7H

#### Operand Format and Number of States Required for Execution

Addressing Mode	Mnemonic	Operands	Instruction Format				No. of States
			1st byte	2nd byte	3rd byte	4th byte	
Immediate	AND.B	#xx:8, Rd	E	rd	IMM		1
Register direct	AND.B	Rs, Rd	1	6	rs	rd	1

#### Notes

## 2.2.4 (2) AND (W)

### AND (AND logical)

### Logical AND

#### Operation

$Rd \wedge (EAs) \rightarrow Rd$

#### Condition Code

I	UI	H	U	N	Z	V	C
—	—	—	—	↑	↓	0	—

#### Assembly-Language Format

AND.W <EAs>, Rd

- H: Previous value remains unchanged.
- N: Set to 1 if the result is negative; otherwise cleared to 0.
- Z: Set to 1 if the result is zero; otherwise cleared to 0.
- V: Always cleared to 0.
- C: Previous value remains unchanged.

#### Operand Size

Word

#### Description

This instruction ANDs the source operand with the contents of a 16-bit register Rd (destination operand) and stores the result in the 16-bit register Rd.

#### Available Registers

Rd: R0 to R7, E0 to E7

Rs: R0 to R7, E0 to E7

#### Operand Format and Number of States Required for Execution

Addressing Mode	Mnemonic	Operands	Instruction Format				No. of States	
			1st byte	2nd byte	3rd byte	4th byte		
Immediate	AND.W	#xx:16, Rd	7	9	6	rd	IMM	2
Register direct	AND.W	Rs, Rd	6	6	rs	rd		1

#### Notes

## 2.2.4 (3) AND (L)

### AND (AND logical)

### Logical AND

#### Operation

ERd  $\wedge$  (EAs)  $\rightarrow$  ERd

#### Condition Code

I	UI	H	U	N	Z	V	C
—	—	—	—	↕	↕	0	—

#### Assembly-Language Format

AND .L <EAs>, ERd

- H: Previous value remains unchanged.  
 N: Set to 1 if the result is negative; otherwise cleared to 0.  
 Z: Set to 1 if the result is zero; otherwise cleared to 0.  
 V: Always cleared to 0.  
 C: Previous value remains unchanged.

#### Operand Size

Longword

#### Description

This instruction ANDs the source operand with the contents of a 32-bit register ERd (destination operand) and stores the result in the 32-bit register ERd.

#### Available Registers

ERd: ER0 to ER7

ERs: ER0 to ER7

#### Operand Format and Number of States Required for Execution

Addressing Mode	Mnemonic	Operands	Instruction Format						No. of States	
			1st byte	2nd byte	3rd byte	4th byte	5th byte	6th byte		
Immediate	AND.L	#xx:32, ERd	7	A	6	0:erd	IMM			3
Register direct	AND.L	ERs, ERd	0	1	F	0	6	6	0:ers:0:erd	2

#### Notes

## 2.2.5 (1) ANDC

### ANDC (AND Control register)

### Logical AND with CCR

#### Operation

CCR  $\wedge$  #IMM  $\rightarrow$  CCR

#### Condition Code

I	UI	H	U	N	Z	V	C
↕	↕	↕	↕	↕	↕	↕	↕

#### Assembly-Language Format

ANDC #xx:8, CCR

- I: Stores the corresponding bit of the result.
- UI: Stores the corresponding bit of the result.
- H: Stores the corresponding bit of the result.
- U: Stores the corresponding bit of the result.
- N: Stores the corresponding bit of the result.
- Z: Stores the corresponding bit of the result.
- V: Stores the corresponding bit of the result.
- C: Stores the corresponding bit of the result.

#### Operand Size

Byte

#### Description

This instruction ANDs the contents of the condition-code register (CCR) with immediate data and stores the result in the condition-code register. No interrupt requests, including NMI, are accepted immediately after execution of this instruction.

#### Operand Format and Number of States Required for Execution

Addressing Mode	Mnemonic	Operands	Instruction Format				No. of States
			1st byte	2nd byte	3rd byte	4th byte	
Immediate	ANDC	#xx:8, CCR	0	6	IMM		1

#### Notes

## 2.2.5 (2) ANDC

### ANDC (AND Control register)

### Logical AND with EXR

#### Operation

$EXR \wedge \#IMM \rightarrow EXR$

#### Condition Code

I	UI	H	U	N	Z	V	C
—	—	—	—	—	—	—	—

#### Assembly-Language Format

ANDC #xx:8, EXR

- H: Previous value remains unchanged.
- N: Previous value remains unchanged.
- Z: Previous value remains unchanged.
- V: Previous value remains unchanged.
- C: Previous value remains unchanged.

#### Operand Size

Byte

#### Description

This instruction ANDs the contents of the extended control register (EXR) with immediate data and stores the result in the extended control register. No interrupt requests, including NMI, are accepted for three states after execution of this instruction.

#### Operand Format and Number of States Required for Execution

Addressing Mode	Mnemonic	Operands	Instruction Format				No. of States
			1st byte	2nd byte	3rd byte	4th byte	
Immediate	ANDC	#xx:8, EXR	0   1	4   1	0   6	IMM	2

#### Notes

## 2.2.6 BAND

### BAND (Bit AND)

### Bit Logical AND

#### Operation

$C \wedge (\text{<bit No.> of <EAd>}) \rightarrow C$

#### Condition Code

I	UI	H	U	N	Z	V	C
—	—	—	—	—	—	—	↕

#### Assembly-Language Format

BAND #xx:3, <EAd>

- H: Previous value remains unchanged.
- N: Previous value remains unchanged.
- Z: Previous value remains unchanged.
- V: Previous value remains unchanged.
- C: Stores the result of the operation.

#### Operand Size

Byte

#### Description

This instruction ANDs a specified bit in the destination operand with the carry flag and stores the result in the carry flag. The bit number is specified by 3-bit immediate data. The destination operand contents remain unchanged.

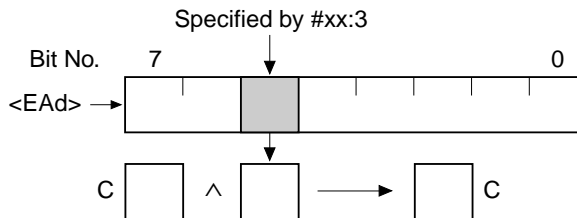

#### Available Registers

Rd: R0L to R7L, R0H to R7H

ERd: ER0 to ER7



**Operand Format and Number of States Required for Execution**

Addressing Mode*	Mnemonic	Operands	Instruction Format								No. of States		
			1st byte	2nd byte	3rd byte	4th byte	5th byte	6th byte	7th byte	8th byte			
Register direct	BAND	#xx:3, Rd	7	6 0:IMM; rd									1
Register indirect	BAND	#xx:3, @ERd	7	C 0:erd; 0	7	6 0:IMM; 0							3
Absolute address	BAND	#xx:3, @aa:8	7	E abs	7	6 0:IMM; 0							3
Absolute address	BAND	#xx:3, @aa:16	6	A 1 0		abs		7	6 0:IMM; 0				4
Absolute address	BAND	#xx:3, @aa:32	6	A 3 0			abs			7	6 0:IMM; 0		5

Note: \* The addressing mode is the addressing mode of the destination operand <EAd>.

**Notes**

For the @aa:8/@aa:16 access range, refer to the relevant microcontroller hardware manual.

**Operation**

If condition is true, then  
 PC + disp → PC  
 else next;

**Condition Code**

I	UI	H	U	N	Z	V	C
—	—	—	—	—	—	—	—

**Assembly-Language Format**

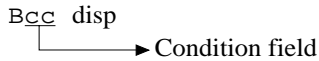
Bcc disp  

H: Previous value remains unchanged.  
 N: Previous value remains unchanged.  
 Z: Previous value remains unchanged.  
 V: Previous value remains unchanged.  
 C: Previous value remains unchanged.

**Operand Size****Description**

If the condition specified in the condition field (cc) is true, a displacement is added to the program counter (PC) and execution branches to the resulting address. If the condition is false, the next instruction is executed. The PC value used in the address calculation is the starting address of the instruction immediately following the Bcc instruction. The displacement is a signed 8-bit or 16-bit value. The branch destination address can be located in the range from -126 to +128 bytes or -32766 to +32768 bytes from the Bcc instruction.

Mnemonic	Meaning	cc	Condition	Signed/Unsigned*
BRA (BT)	Always (true)	0000	True	
BRN (BF)	Never (false)	0001	False	
BHI	High	0010	CvZ = 0	X > Y (unsigned)
BLS	Low or Same	0011	CvZ = 1	X ≤ Y (unsigned)
BCC (BHS)	Carry Clear (High or Same)	0100	C = 0	X ≥ Y (unsigned)
BCS (BLO)	Carry Set (LOW)	0101	C = 1	X < Y (unsigned)
BNE	Not Equal	0110	Z = 0	X ≠ Y (unsigned or signed)
BEQ	Equal	0111	Z = 1	X = Y (unsigned or signed)
BVC	oVerflow Clear	1000	V = 0	
BVS	oVerflow Set	1001	V = 1	
BPL	PLus	1010	N = 0	
BMI	MInus	1011	N = 1	
BGE	Greater or Equal	1100	N⊕V = 0	X ≥ Y (signed)
BLT	Less Than	1101	N⊕V = 1	X < Y (signed)
BGT	Greater Than	1110	Zv(N⊕V) = 0	X > Y (signed)
BLE	Less or Equal	1111	Zv(N⊕V) = 1	X ≤ Y (signed)

Note: \* If the immediately preceding instruction is a CMP instruction, X is the general register contents (destination operand) and Y is the source operand.

## Operand Format and Number of States Required for Execution

Addressing Mode	Mnemonic	Operands	Instruction Format				No. of States
			1st byte	2nd byte	3rd byte	4th byte	
Program-counter relative	BRA (BT)	d:8	4	0	disp		2
		d:16	5	8	0	0	disp
Program-counter relative	BRN (BF)	d:8	4	1	disp		2
		d:16	5	8	1	0	disp
Program-counter relative	BHI	d:8	4	2	disp		2
		d:16	5	8	2	0	disp
Program-counter relative	BLS	d:8	4	3	disp		2
		d:16	5	8	3	0	disp
Program-counter relative	Bcc (BHS)	d:8	4	4	disp		2
		d:16	5	8	4	0	disp
Program-counter relative	BCS (BLO)	d:8	4	5	disp		2
		d:16	5	8	5	0	disp
Program-counter relative	BNE	d:8	4	6	disp		2
		d:16	5	8	6	0	disp
Program-counter relative	BEQ	d:8	4	7	disp		2
		d:16	5	8	7	0	disp
Program-counter relative	BVC	d:8	4	8	disp		2
		d:16	5	8	8	0	disp
Program-counter relative	BVS	d:8	4	9	disp		2
		d:16	5	8	9	0	disp
Program-counter relative	BPL	d:8	4	A	disp		2
		d:16	5	8	A	0	disp
Program-counter relative	BMI	d:8	4	B	disp		2
		d:16	5	8	B	0	disp
Program-counter relative	BGE	d:8	4	C	disp		2
		d:16	5	8	C	0	disp
Program-counter relative	BLT	d:8	4	D	disp		2
		d:16	5	8	D	0	disp
Program-counter relative	BGT	d:8	4	E	disp		2
		d:16	5	8	E	0	disp
Program-counter relative	BLE	d:8	4	F	disp		2
		d:16	5	8	F	0	disp

## Notes

1. The branch destination address must be even.
2. In machine language BRA, BRN, BCC, and BCS are identical to BT, BF, BHS, and BLO, respectively.

## 2.2.8 BCLR

### BCLR (Bit CLearR)

Bit Clear

#### Operation

0 → (<bit No.> of <EAd>)

#### Condition Code

I	UI	H	U	N	Z	V	C
—	—	—	—	—	—	—	—

#### Assembly-Language Format

BCLR #xx:3, <EAd>

BCLR Rn, <EAd>

H: Previous value remains unchanged.

N: Previous value remains unchanged.

Z: Previous value remains unchanged.

V: Previous value remains unchanged.

C: Previous value remains unchanged.

#### Operand Size

Byte

#### Description

This instruction clears a specified bit in the destination operand to 0. The bit number can be specified by 3-bit immediate data, or by the lower three bits of an 8-bit register Rn. The specified bit is not tested. The condition-code flags are not altered.

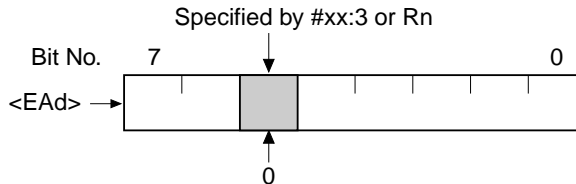

#### Available Registers

Rd: R0L to R7L, R0H to R7H

ERd: ER0 to ER7

Rn: R0L to R7L, R0H to R7H

**Operand Format and Number of States Required for Execution**

Addressing Mode*	Mnemonic	Operands	Instruction Format								No. of States						
			1st byte	2nd byte	3rd byte	4th byte	5th byte	6th byte	7th byte	8th byte							
Register direct	BCLR	#xx:3, Rd	7	2	0:IMM	rd								1			
Register indirect	BCLR	#xx:3, @ERd	7	D	0:erd	0	7	2	0:IMM	0				4			
Absolute address	BCLR	#xx:3, @aa:8	7	F	abs		7	2	0:IMM	0				4			
Absolute address	BCLR	#xx:3, @aa:16	6	A	1	8	abs		7	2	0:IMM	0		5			
Absolute address	BCLR	#xx:3, @aa:32	6	A	3	8	abs						7	2	0:IMM	0	6
Register direct	BCLR	Rn, Rd	6	2	rn	rd											1
Register indirect	BCLR	Rn, @ERd	7	D	0:erd	0	6	2	rn	0							4
Absolute address	BCLR	Rn, @aa:8	7	F	abs		6	2	rn	0							4
Absolute address	BCLR	Rn, @aa:16	6	A	1	8	abs		6	2	rn	0					5
Absolute address	BCLR	Rn, @aa:32	6	A	3	8	abs						6	2	rn	0	6

Note: \* The addressing mode is the addressing mode of the destination operand <EAd>.

**Notes**

For the @aa:8/@aa:16 access range, refer to the relevant microcontroller hardware manual.

## 2.2.9 BIAND

### BIAND (Bit Invert AND)

### Bit Logical AND

#### Operation

$C \wedge [\neg (\text{<bit No.> of <EAd>})] \rightarrow C$

#### Condition Code

I	UI	H	U	N	Z	V	C
—	—	—	—	—	—	—	↕

#### Assembly-Language Format

BIAND #xx:3, <EAd>

- H: Previous value remains unchanged.
- N: Previous value remains unchanged.
- Z: Previous value remains unchanged.
- V: Previous value remains unchanged.
- C: Stores the result of the operation.

#### Operand Size

Byte

#### Description

This instruction ANDs the inverse of a specified bit in the destination operand with the carry flag and stores the result in the carry flag. The bit number is specified by 3-bit immediate data. The destination operand contents remain unchanged.

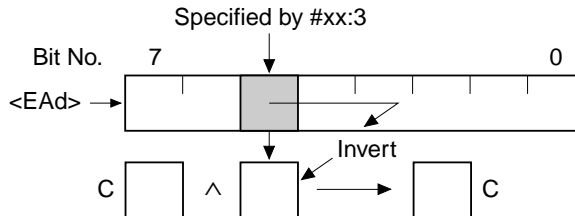

#### Available Registers

Rd: R0L to R7L, R0H to R7H

ERd: ER0 to ER7

## Operand Format and Number of States Required for Execution

Addressing Mode*	Mnemonic	Operands	Instruction Format								No. of States		
			1st byte	2nd byte	3rd byte	4th byte	5th byte	6th byte	7th byte	8th byte			
Register direct	BIAND	#xx:3, Rd	7	6	1:IMM: rd								1
Register indirect	BIAND	#xx:3, @ERd	7	C	0:erd: 0	7	6	1:IMM: 0					3
Absolute address	BIAND	#xx:3, @aa:8	7	E	abs	7	6	1:IMM: 0					3
Absolute address	BIAND	#xx:3, @aa:16	6	A	1	0	abs	7	6	1:IMM: 0			4
Absolute address	BIAND	#xx:3, @aa:32	6	A	3	0	abs	7	6	1:IMM: 0			5

Note: \* The addressing mode is the addressing mode of the destination operand <EAd>.

## Notes

For the @aa:8/@aa:16 access range, refer to the relevant microcontroller hardware manual.

## 2.2.10 BILD

### BILD (Bit Invert Load)

Bit Load

#### Operation

$\neg$  (<bit No.> of <EAd>)  $\rightarrow$  C

#### Condition Code

I	UI	H	U	N	Z	V	C
—	—	—	—	—	—	—	↕

#### Assembly-Language Format

BILD #xx:3, <EAd>

- H: Previous value remains unchanged.
- N: Previous value remains unchanged.
- Z: Previous value remains unchanged.
- V: Previous value remains unchanged.
- C: Loaded with the inverse of the specified bit.

#### Operand Size

Byte

#### Description

This instruction loads the inverse of a specified bit from the destination operand into the carry flag. The bit number is specified by 3-bit immediate data. The destination operand contents remain unchanged.

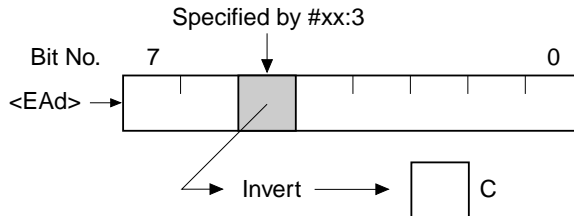

#### Available Registers

Rd: R0L to R7L, R0H to R7H

ERd: ER0 to ER7



Operand Format and Number of States Required for Execution

Addressing Mode*	Mnemonic	Operands	Instruction Format								No. of States		
			1st byte	2nd byte	3rd byte	4th byte	5th byte	6th byte	7th byte	8th byte			
Register direct	BILD	#xx:3, Rd	7	7 1:IMM rd									1
Register indirect	BILD	#xx:3, @ERd	7	C 0:erd	7	7 1:IMM 0							3
Absolute address	BILD	#xx:3, @aa:8	7	E abs	7	7 1:IMM 0							3
Absolute address	BILD	#xx:3, @aa:16	6	A 1 0		abs		7	7 1:IMM 0				4
Absolute address	BILD	#xx:3, @aa:32	6	A 3 0			abs			7	7 1:IMM 0		5

Note: \* The addressing mode is the addressing mode of the destination operand <EAd>.

Notes

For the @aa:8/@aa:16 access range, refer to the relevant microcontroller hardware manual.

## 2.2.11 BIOR

### BIOR (Bit Invert inclusive OR)

Bit Logical OR

#### Operation

$C \vee [\neg (\text{<bit No.> of <EAd>})] \rightarrow C$

#### Condition Code

I	UI	H	U	N	Z	V	C
—	—	—	—	—	—	—	↕

#### Assembly-Language Format

BIOR #xx:3, <EAd>

- H: Previous value remains unchanged.
- N: Previous value remains unchanged.
- Z: Previous value remains unchanged.
- V: Previous value remains unchanged.
- C: Stores the result of the operation.

#### Operand Size

Byte

#### Description

This instruction ORs the inverse of a specified bit in the destination operand with the carry flag and stores the result in the carry flag. The bit number is specified by 3-bit immediate data. The destination operand contents remain unchanged.

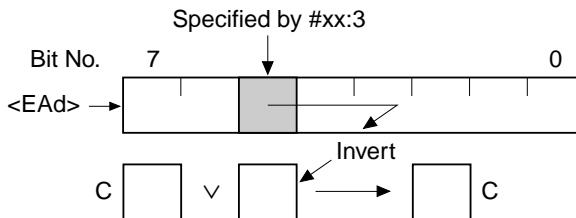

#### Available Registers

Rd: R0L to R7L, R0H to R7H

ERd: ER0 to ER7

Operand Format and Number of States Required for Execution

Addressing Mode*	Mnemonic	Operands	Instruction Format								No. of States		
			1st byte	2nd byte	3rd byte	4th byte	5th byte	6th byte	7th byte	8th byte			
Register direct	BIOR	#xx:3, Rd	7	4	1:IMM: rd								1
Register indirect	BIOR	#xx:3, @ERd	7	C	0:erd: 0	7	4	1:IMM: 0					3
Absolute address	BIOR	#xx:3, @aa:8	7	E	abs	7	4	1:IMM: 0					3
Absolute address	BIOR	#xx:3, @aa:16	6	A	1	0	abs	7	4	1:IMM: 0			4
Absolute address	BIOR	#xx:3, @aa:32	6	A	3	0	abs	7	4	1:IMM: 0			5

Note: \* The addressing mode is the addressing mode of the destination operand <EAd>.

Notes

For the @aa:8/@aa:16 access range, refer to the relevant microcontroller hardware manual.

## 2.2.12 BIST

### BIST (Bit Invert STore)

Bit Store

---

#### Operation

$\neg C \rightarrow (\text{<bit No.> of <EAd>})$

#### Condition Code

I	UI	H	U	N	Z	V	C
—	—	—	—	—	—	—	—

---

#### Assembly-Language Format

BIST #xx:3, <EAd>

H: Previous value remains unchanged.  
N: Previous value remains unchanged.  
Z: Previous value remains unchanged.  
V: Previous value remains unchanged.  
C: Previous value remains unchanged.

---

#### Operand Size

Byte

---

#### Description

This instruction stores the inverse of the carry flag in a specified bit location in the destination operand. The bit number is specified by 3-bit immediate data. Other bits in the destination operand remain unchanged.

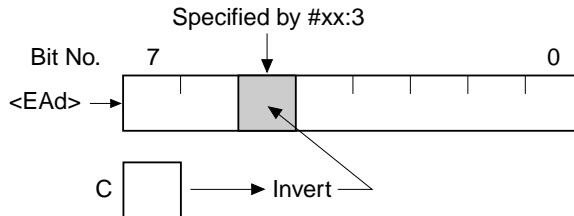

---

#### Available Registers

Rd: R0L to R7L, R0H to R7H

ERd: ER0 to ER7

**Operand Format and Number of States Required for Execution**

Addressing Mode*	Mnemonic	Operands	Instruction Format								No. of States		
			1st byte	2nd byte	3rd byte	4th byte	5th byte	6th byte	7th byte	8th byte			
Register direct	BIST	#xx:3, Rd	6	7 1:IMM: rd									1
Register indirect	BIST	#xx:3, @ERd	7	D 0:erd	6	7 1:IMM: 0							4
Absolute address	BIST	#xx:3, @aa:8	7	F abs	6	7 1:IMM: 0							4
Absolute address	BIST	#xx:3, @aa:16	6	A 1	8	abs	6	7 1:IMM: 0					5
Absolute address	BIST	#xx:3, @aa:32	6	A 3	8	abs	6	7 1:IMM: 0					6

Note: \* The addressing mode is the addressing mode of the destination operand <EAd>.

**Notes**

For the @aa:8/@aa:16 access range, refer to the relevant microcontroller hardware manual.

## 2.2.13 BIXOR

### BIXOR (Bit Invert eXclusive OR)

### Bit Exclusive Logical OR

#### Operation

$C \oplus [\neg (\text{bit No.} \text{ of } \langle \text{EAd} \rangle)] \rightarrow C$

#### Condition Code

I	UI	H	U	N	Z	V	C
—	—	—	—	—	—	—	↕

#### Assembly-Language Format

BIXOR #xx:3, <EAd>

- H: Previous value remains unchanged.
- N: Previous value remains unchanged.
- Z: Previous value remains unchanged.
- V: Previous value remains unchanged.
- C: Stores the result of the operation.

#### Operand Size

Byte

#### Description

This instruction exclusively ORs the inverse of a specified bit in the destination operand with the carry flag and stores the result in the carry flag. The bit number is specified by 3-bit immediate data. The destination operand contents remain unchanged.

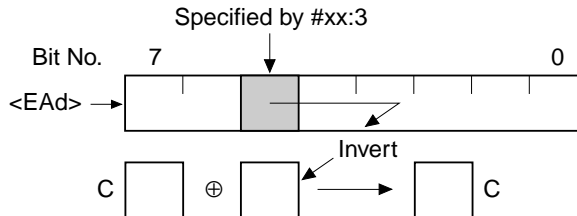

#### Available Registers

Rd: R0L to R7L, R0H to R7H

ERd: ER0 to ER7

Operand Format and Number of States Required for Execution

Addressing Mode*	Mnemonic	Operands	Instruction Format								No. of States		
			1st byte	2nd byte	3rd byte	4th byte	5th byte	6th byte	7th byte	8th byte			
Register direct	BIXOR	#xx:3, Rd	7	5 1:IMM; rd									1
Register indirect	BIXOR	#xx:3, @ERd	7	C 0:erd	7	5 1:IMM; 0							3
Absolute address	BIXOR	#xx:3, @aa:8	7	E abs	7	5 1:IMM; 0							3
Absolute address	BIXOR	#xx:3, @aa:16	6	A 1 0		abs		7	5 1:IMM; 0				4
Absolute address	BIXOR	#xx:3, @aa:32	6	A 3 0			abs			7	5 1:IMM; 0		5

Note: \* The addressing mode is the addressing mode of the destination operand <EAd>.

Notes

For the @aa:8/@aa:16 access range, refer to the relevant microcontroller hardware manual.

## 2.2.14 BLD

### BLD (Bit Load)

Bit Load

#### Operation

(<Bit No.> of <EAd>) → C

#### Condition Code

I	UI	H	U	N	Z	V	C
—	—	—	—	—	—	—	↕

#### Assembly-Language Format

BLD #xx:3, <EAd>

- H: Previous value remains unchanged.
- N: Previous value remains unchanged.
- Z: Previous value remains unchanged.
- V: Previous value remains unchanged.
- C: Loaded from the specified bit.

#### Operand Size

Byte

#### Description

This instruction loads a specified bit from the destination operand into the carry flag. The bit number is specified by 3-bit immediate data. The destination operand contents remain unchanged.

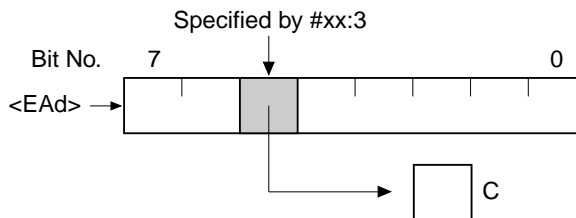

#### Available Registers

Rd: R0L to R7L, R0H to R7H

ERd: ER0 to ER7



Operand Format and Number of States Required for Execution

Addressing Mode*	Mnemonic	Operands	Instruction Format								No. of States		
			1st byte	2nd byte	3rd byte	4th byte	5th byte	6th byte	7th byte	8th byte			
Register direct	BLD	#xx:3, Rd	7	7 0:IMM; rd									1
Register indirect	BLD	#xx:3, @ERd	7	C 0:erd	7	7 0:IMM; 0							3
Absolute address	BLD	#xx:3, @aa:8	7	E abs	7	7 0:IMM; 0							3
Absolute address	BLD	#xx:3, @aa:16	6	A 1 0		abs		7	7 0:IMM; 0				4
Absolute address	BLD	#xx:3, @aa:32	6	A 3 0				abs			7	7 0:IMM; 0	5

Note: \* The addressing mode is the addressing mode of the destination operand <EAd>.

Notes

For the @aa:8/@aa:16 access range, refer to the relevant microcontroller hardware manual.

## 2.2.15 BNOT

### BNOT (Bit NOT)

Bit NOT

#### Operation

$\neg$  (<bit No.> of <EAd>)  $\rightarrow$  (bit No. of <EAd>)

#### Condition Code

I	UI	H	U	N	Z	V	C
—	—	—	—	—	—	—	—

#### Assembly-Language Format

BNOT #xx:3, <EAd>

BNOT Rn, <EAd>

H: Previous value remains unchanged.

N: Previous value remains unchanged.

Z: Previous value remains unchanged.

V: Previous value remains unchanged.

C: Previous value remains unchanged.

#### Operand Size

Byte

#### Description

This instruction inverts a specified bit in the destination operand. The bit number is specified by 3-bit immediate data or by the lower 3 bits of an 8-bit register Rn. The specified bit is not tested. The condition code remains unchanged.

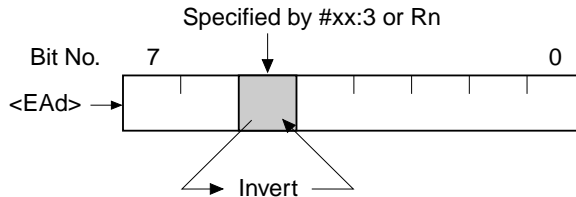

#### Available Registers

Rd: R0L to R7L, R0H to R7H

ERd: ER0 to ER7

Rn: R0L to R7L, R0H to R7H

**Operand Format and Number of States Required for Execution**

Addressing Mode*	Mnemonic	Operands	Instruction Format								No. of States		
			1st byte	2nd byte	3rd byte	4th byte	5th byte	6th byte	7th byte	8th byte			
Register direct	BNOT	#xx:3, Rd	7 1	0:IMM: rd									1
Register indirect	BNOT	#xx:3, @ERd	7 D	0:erd: 0	7 1	0:IMM: 0							4
Absolute address	BNOT	#xx:3, @aa:8	7 F	abs	7 1	0:IMM: 0							4
Absolute address	BNOT	#xx:3, @aa:16	6 A	1 8	abs			7 1	0:IMM: 0				5
Absolute address	BNOT	#xx:3, @aa:32	6 A	3 8			abs			7 1	0:IMM: 0		6
Register direct	BNOT	Rn, Rd	6 1	m rd									1
Register indirect	BNOT	Rn, @ERd	7 D	0:erd: 0	6 1	m 0							4
Absolute address	BNOT	Rn, @aa:8	7 F	abs	6 1	m 0							4
Absolute address	BNOT	Rn, @aa:16	6 A	1 8	abs			6 1	m 0				5
Absolute address	BNOT	Rn, @aa:32	6 A	3 8			abs			6 1	m 0		6

Note: \* The addressing mode is the addressing mode of the destination operand <EAd>.

**Notes**

For the @aa:8/@aa:16 access range, refer to the relevant microcontroller hardware manual.

## 2.2.16 BOR

### BOR (Bit inclusive OR)

Bit Logical OR

#### Operation

$C \vee (\text{<bit No.> of <EAd>) \rightarrow C$

#### Condition Code

I	UI	H	U	N	Z	V	C
—	—	—	—	—	—	—	↕

#### Assembly-Language Format

BOR #xx:3, <EAd>

- H: Previous value remains unchanged.
- N: Previous value remains unchanged.
- Z: Previous value remains unchanged.
- V: Previous value remains unchanged.
- C: Stores the result of the operation.

#### Operand Size

Byte

#### Description

This instruction ORs a specified bit in the destination operand with the carry flag and stores the result in the carry flag. The bit number is specified by 3-bit immediate data. The destination operand contents remain unchanged.

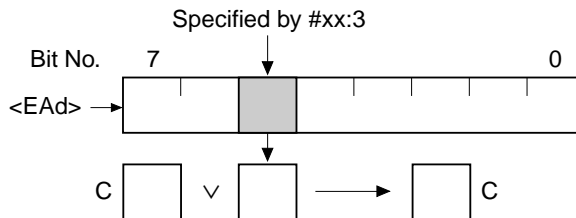

#### Available Registers

Rd: R0L to R7L, R0H to R7H

ERd: ER0 to ER7

**Operand Format and Number of States Required for Execution**

Addressing Mode*	Mnemonic	Operands	Instruction Format								No. of States		
			1st byte	2nd byte	3rd byte	4th byte	5th byte	6th byte	7th byte	8th byte			
Register direct	BOR	#xx:3, Rd	7	4 0:IMM; rd									1
Register indirect	BOR	#xx:3, @ERd	7	C 0:erd; 0	7	4 0:IMM; 0							3
Absolute address	BOR	#xx:3, @aa:8	7	E abs	7	4 0:IMM; 0							3
Absolute address	BOR	#xx:3, @aa:16	6	A 1 0		abs		7	4 0:IMM; 0				4
Absolute address	BOR	#xx:3, @aa:32	6	A 3 0			abs			7	4 0:IMM; 0		5

Note: \* The addressing mode is the addressing mode of the destination operand <EAd>.

**Notes**

For the @aa:8/@aa:16 access range, refer to the relevant microcontroller hardware manual.

## 2.2.17 BSET

### BSET (Bit SET)

Bit Set

---

#### Operation

1 → (<bit No.> of <EAd>)

#### Condition Code

I	UI	H	U	N	Z	V	C
—	—	—	—	—	—	—	—

---

#### Assembly-Language Format

BSET #xx:3, <EAd>

BSET Rn, <EAd>

H: Previous value remains unchanged.

N: Previous value remains unchanged.

Z: Previous value remains unchanged.

V: Previous value remains unchanged.

C: Previous value remains unchanged.

---

#### Operand Size

Byte

---

#### Description

This instruction sets a specified bit in the destination operand to 1. The bit number can be specified by 3-bit immediate data, or by the lower three bits of an 8-bit register Rn. The specified bit is not tested. The condition code flags are not altered.

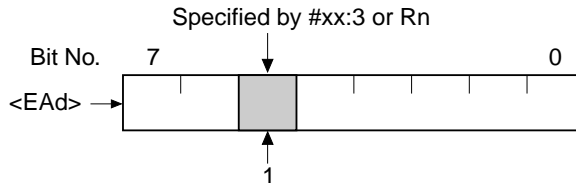

---

#### Available Registers

Rd: R0L to R7L, R0H to R7H

ERd: ER0 to ER7

Rn: R0L to R7L, R0H to R7H

Operand Format and Number of States Required for Execution

Addressing Mode*	Mnemonic	Operands	Instruction Format								No. of States		
			1st byte	2nd byte	3rd byte	4th byte	5th byte	6th byte	7th byte	8th byte			
Register direct	BSET	#xx:3, Rd	7 0	0:IMM: rd									1
Register indirect	BSET	#xx:3, @ERd	7 D	0:erd: 0	7 0	0:IMM: 0							4
Absolute address	BSET	#xx:3, @aa:8	7 F	abs	7 0	0:IMM: 0							4
Absolute address	BSET	#xx:3, @aa:16	6 A	1 8	abs			7 0	0:IMM: 0				5
Absolute address	BSET	#xx:3, @aa:32	6 A	3 8			abs			7 0	0:IMM: 0		6
Register direct	BSET	Rn, Rd	6 0	m rd									1
Register indirect	BSET	Rn, @ERd	7 D	0:erd: 0	6 0	m 0							4
Absolute address	BSET	Rn, @aa:8	7 F	abs	6 0	m 0							4
Absolute address	BSET	Rn, @aa:16	6 A	1 8			abs	6 0	m 0				5
Absolute address	BSET	Rn, @aa:32	6 A	3 8			abs			6 0	m 0		6

Note: \* The addressing mode is the addressing mode of the destination operand <EAd>.

Notes

For the @aa:8/@aa:16 access range, refer to the relevant microcontroller hardware manual.

## 2.2.18 BSR

### BSR (Branch to SubRoutine)

### Branch to Subroutine

#### Operation

PC → @-SP

PC + disp → PC

#### Condition Code

I	UI	H	U	N	Z	V	C
—	—	—	—	—	—	—	—

#### Assembly-Language Format

BSR disp

H: Previous value remains unchanged.

N: Previous value remains unchanged.

Z: Previous value remains unchanged.

V: Previous value remains unchanged.

C: Previous value remains unchanged.

#### Operand Size

#### Description

This instruction branches to a subroutine at a specified address. It pushes the program counter (PC) value onto the stack as a restart address, then adds a specified displacement to the PC value and branches to the resulting address. The PC value pushed onto the stack is the address of the instruction following the BSR instruction. The displacement is a signed 8-bit or 16-bit value, so the possible branching range is -126 to +128 bytes or -32766 to +32768 bytes from the address of the BSR instruction.

#### Operand Format and Number of States Required for Execution

Addressing Mode	Mnemonic	Operands	Instruction Format				No. of States	
			1st byte	2nd byte	3rd byte	4th byte	Normal	Advanced
Program-counter relative	BSR	d:8	5	5	disp		3	4
		d:16	5	C	0	0	disp	4



**Notes**

The stack structure differs between normal mode and advanced mode. In normal mode only the lower 16 bits of the program counter are pushed onto the stack.

Ensure that the branch destination address is even.

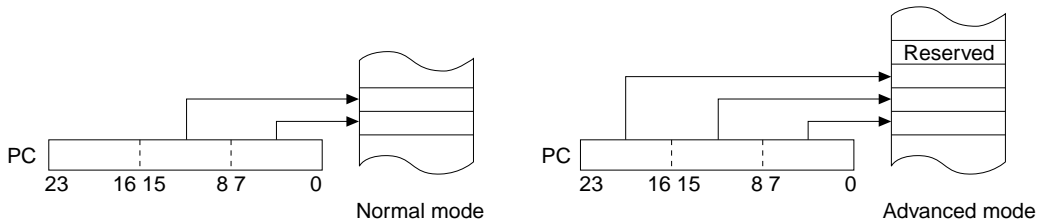

## 2.2.19 BST

### BST (Bit STore)

Bit Store

---

#### Operation

C → (<bit No.> of <EAd>)

#### Condition Code

I	UI	H	U	N	Z	V	C
—	—	—	—	—	—	—	—

---

#### Assembly-Language Format

BST #xx:3, <EAd>

H: Previous value remains unchanged.

N: Previous value remains unchanged.

Z: Previous value remains unchanged.

V: Previous value remains unchanged.

C: Previous value remains unchanged.

---

#### Operand Size

Byte

---

#### Description

This instruction stores the carry flag in a specified bit location in the destination operand. The bit number is specified by 3-bit immediate data.

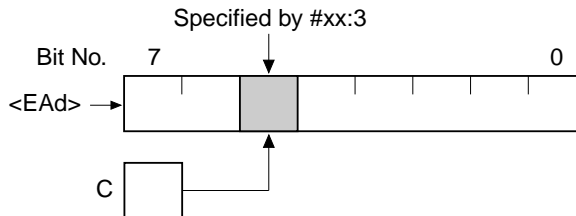

---

#### Available Registers

Rd: R0L to R7L, R0H to R7H

ERd: ER0 to ER7

**Operand Format and Number of States Required for Execution**

Addressing Mode*	Mnemonic	Operands	Instruction Format								No. of States	
			1st byte	2nd byte	3rd byte	4th byte	5th byte	6th byte	7th byte	8th byte		
Register direct	BST	#xx:3, Rd	6	7 0:IMM: rd								1
Register indirect	BST	#xx:3, @ERd	7	D 0:erd: 0	6	7 0:IMM: 0						4
Absolute address	BST	#xx:3, @aa:8	7	F abs	6	7 0:IMM: 0						4
Absolute address	BST	#xx:3, @aa:16	6	A 1 8		abs	6	7 0:IMM: 0				5
Absolute address	BST	#xx:3, @aa:32	6	A 3 8		abs	6	7 0:IMM: 0				6

Note: \* The addressing mode is the addressing mode of the destination operand <EAd>.

**Notes**

For the @aa:8/@aa:16 access range, refer to the relevant microcontroller hardware manual.

**Operation**
 $\neg$  (<Bit No.> of <EAd>)  $\rightarrow$  Z
**Condition Code**

I	UI	H	U	N	Z	V	C
—	—	—	—	—	↑	—	—

**Assembly-Language Format**

BTST #xx:3, &lt;EAd&gt;

BTST Rn, &lt;EAd&gt;

**Operand Size**

Byte

H: Previous value remains unchanged.

N: Previous value remains unchanged.

Z: Set to 1 if the specified bit is zero;  
otherwise cleared to 0.

V: Previous value remains unchanged.

C: Previous value remains unchanged.

**Description**

This instruction tests a specified bit in the destination operand and sets or clears the zero flag according to the result. The bit number can be specified by 3-bit immediate data, or by the lower three bits of an 8-bit register Rn. The destination operand contents remain unchanged.

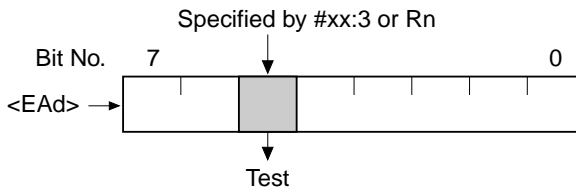
**Available Registers**

Rd: R0L to R7L, R0H to R7H

ERd: ER0 to ER7

Rn: R0L to R7L, R0H to R7H

Operand Format and Number of States Required for Execution

Addressing Mode*	Mnemonic	Operands	Instruction Format								No. of States				
			1st byte	2nd byte	3rd byte	4th byte	5th byte	6th byte	7th byte	8th byte					
Register direct	BTST	#xx:3, Rd	7	3	0:IMM: rd								1		
Register indirect	BTST	#xx:3, @ERd	7	C	0:erd: 0	7	3	0:IMM: 0					3		
Absolute address	BTST	#xx:3, @aa:8	7	E	abs	7	3	0:IMM: 0					3		
Absolute address	BTST	#xx:3, @aa:16	6	A	1	0	abs	7	3	0:IMM: 0			4		
Absolute address	BTST	#xx:3, @aa:32	6	A	3	0	abs	abs			7	3	0:IMM: 0	5	
Register direct	BTST	Rn, Rd	6	3	rn	rd								1	
Register indirect	BTST	Rn, @ERd	7	C	0:erd: 0	6	3	rn	0					3	
Absolute address	BTST	Rn, @aa:8	7	E	abs	6	3	rn	0					3	
Absolute address	BTST	Rn, @aa:16	6	A	1	0	abs	6	3	rn	0			4	
Absolute address	BTST	Rn, @aa:32	6	A	3	0	abs	abs			6	3	rn	0	5

Note: \* The addressing mode is the addressing mode of the destination operand <EAAd>.

Notes

For the @aa:8/@aa:16 access range, refer to the relevant microcontroller hardware manual.

## 2.2.21 BXOR

### BXOR (Bit eXclusive OR)

### Bit Exclusive Logical OR

#### Operation

$C \oplus (\text{<bit No.> of <EAd>}) \rightarrow C$

#### Condition Code

I	UI	H	U	N	Z	V	C
—	—	—	—	—	—	—	↕

#### Assembly-Language Format

BXOR #xx:3, <EAd>

H: Previous value remains unchanged.

N: Previous value remains unchanged.

Z: Previous value remains unchanged.

V: Previous value remains unchanged.

C: Stores the result of the operation.

#### Operand Size

Byte

#### Description

This instruction exclusively ORs a specified bit in the destination operand with the carry flag and stores the result in the carry flag. The bit number is specified by 3-bit immediate data. The destination operand contents remain unchanged.

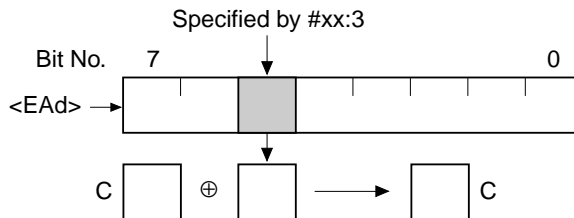

#### Available Registers

Rd: R0L to R7L, R0H to R7H

ERd: ER0 to ER7

Operand Format and Number of States Required for Execution

Addressing Mode*	Mnemonic	Operands	Instruction Format								No. of States		
			1st byte	2nd byte	3rd byte	4th byte	5th byte	6th byte	7th byte	8th byte			
Register direct	BXOR	#xx:3, Rd	7	5 0:IMM; rd									1
Register indirect	BXOR	#xx:3, @ERd	7	C 0:erd	7	5 0:IMM; 0							3
Absolute address	BXOR	#xx:3, @aa:8	7	E abs	7	5 0:IMM; 0							3
Absolute address	BXOR	#xx:3, @aa:16	6	A 1 0		abs		7	5 0:IMM; 0				4
Absolute address	BXOR	#xx:3, @aa:32	6	A 3 0			abs			7	5 0:IMM; 0		5

Note: \* The addressing mode is the addressing mode of the destination operand <EAd>.

Notes

For the @aa:8/@aa:16 access range, refer to the relevant microcontroller hardware manual.

## 2.2.22 CLRMAC

### CLRMAC (CLeaR MAC register)

### Initialize Multiply-Accumulate Register

#### Operation

0 → MACH, MACL

#### Condition Code

I	UI	H	U	N	Z	V	C
—	—	—	—	—	—	—	—

#### Assembly-Language Format

CLRMAC

- H: Previous value remains unchanged.
- N: Previous value remains unchanged.
- Z: Previous value remains unchanged.
- V: Previous value remains unchanged.
- C: Previous value remains unchanged.

#### Operand Size

—

#### Description

This instruction simultaneously clears registers MACH and MACL.

It is supported only by the H8S/2600 CPU.

#### Operand Format and Number of States Required for Execution

Addressing Mode	Mnemonic	Operands	Instruction Format				No. of States	
			1st byte	2nd byte	3rd byte	4th byte		
—	CLRMAC	—	0	1	A	0		2*

Note: \* A maximum of three additional states are required for execution of this instruction within three states after execution of a MAC instruction. For example, if there is a one-state instruction (such as NOP) between the MAC instruction and this instruction, this instruction will be two states longer.

#### Notes

Execution of this instruction also clears the overflow flag in the multiplier to 0.



## 2.2.23 (1) CMP (B)

### CMP (CoMPare)

Compare

#### Operation

Rd – (EAs), set/clear CCR

#### Condition Code

I	UI	H	U	N	Z	V	C
—	—	↕	—	↕	↕	↕	↕

#### Assembly-Language Format

CMP .B <EAs>, Rd

#### Operand Size

Byte

- H: Set to 1 if there is a borrow at bit 3; otherwise cleared to 0.
- N: Set to 1 if the result is negative; otherwise cleared to 0.
- Z: Set to 1 if the result is zero; otherwise cleared to 0.
- V: Set to 1 if an overflow occurs; otherwise cleared to 0.
- C: Set to 1 if there is a borrow at bit 7; otherwise cleared to 0.

#### Description

This instruction subtracts the source operand from the contents of an 8-bit register Rd (destination operand) and sets or clears the condition code bits according to the result. The contents of the 8-bit register Rd remain unchanged.

#### Available Registers

Rd: R0L to R7L, R0H to R7H

Rs: R0L to R7L, R0H to R7H

#### Operand Format and Number of States Required for Execution

Addressing Mode	Mnemonic	Operands	Instruction Format				No. of States
			1st byte	2nd byte	3rd byte	4th byte	
Immediate	CMP.B	#xx:8, Rd	A	rd	IMM		1
Register direct	CMP.B	Rs, Rd	1	C	rs	rd	1

#### Notes

## 2.2.23 (2) CMP (W)

### CMP (CoMPare)

Compare

#### Operation

Rd – (EAs), set/clear CCR

#### Condition Code

I	UI	H	U	N	Z	V	C
—	—	↕	—	↕	↕	↕	↕

#### Assembly-Language Format

CMP.W <EAs>, Rd

#### Operand Size

Word

- H: Set to 1 if there is a borrow at bit 11; otherwise cleared to 0.
- N: Set to 1 if the result is negative; otherwise cleared to 0.
- Z: Set to 1 if the result is zero; otherwise cleared to 0.
- V: Set to 1 if an overflow occurs; otherwise cleared to 0.
- C: Set to 1 if there is a borrow at bit 15; otherwise cleared to 0.

#### Description

This instruction subtracts the source operand from the contents of a 16-bit register Rd (destination operand) and sets or clears the condition code bits according to the result. The contents of the 16-bit register Rd remain unchanged.

#### Available Registers

Rd: R0 to R7, E0 to E7

Rs: R0 to R7, E0 to E7

#### Operand Format and Number of States Required for Execution

Addressing Mode	Mnemonic	Operands	Instruction Format				No. of States	
			1st byte	2nd byte	3rd byte	4th byte		
Immediate	CMP.W	#xx:16, Rd	7	9	2	rd	IMM	2
Register direct	CMP.W	Rs, Rd	1	D	rs	rd		1

#### Notes

## 2.2.23 (3) CMP (L)

### CMP (CoMPare)

Compare

#### Operation

ERd – (EAs), set/clear CCR

#### Condition Code

I	UI	H	U	N	Z	V	C
—	—	↕	—	↕	↕	↕	↕

#### Assembly-Language Format

CMP .L <EAs>, ERd

- H: Set to 1 if there is a borrow at bit 27; otherwise cleared to 0.
- N: Set to 1 if the result is negative; otherwise cleared to 0.
- Z: Set to 1 if the result is zero; otherwise cleared to 0.
- V: Set to 1 if an overflow occurs; otherwise cleared to 0.
- C: Set to 1 if there is a borrow at bit 31; otherwise cleared to 0.

#### Operand Size

Longword

#### Description

This instruction subtracts the source operand from the contents of a 32-bit register ERd (destination operand) and sets or clears the condition code bits according to the result. The contents of the 32-bit register ERd remain unchanged.

#### Available Registers

ERd: ER0 to ER7

ERs: ER0 to ER7

#### Operand Format and Number of States Required for Execution

Addressing Mode	Mnemonic	Operands	Instruction Format						No. of States	
			1st byte	2nd byte	3rd byte	4th byte	5th byte	6th byte		
Immediate	CMP.L	#xx:32, ERd	7	A	2	0:erd	IMM			3
Register direct	CMP.L	ERs, ERd	1	F	1	ers	0:erd			1

#### Notes

**DAA (Decimal Adjust Add)****Decimal Adjust****Operation**

Rd (decimal adjust) → Rd

**Condition Code**

I	UI	H	U	N	Z	V	C
—	—	*	—	↕	↕	*	↕

**Assembly-Language Format**

DAA Rd

**Operand Size**

Byte

- H: Undetermined (no guaranteed value).  
 N: Set to 1 if the adjusted result is negative; otherwise cleared to 0.  
 Z: Set to 1 if the adjusted result is zero; otherwise cleared to 0.  
 V: Undetermined (no guaranteed value).  
 C: Set to 1 if there is a carry at bit 7; otherwise left unchanged.

**Description**

Given that the result of an addition operation performed by an ADD.B or ADDX instruction on 4-bit BCD data is contained in an 8-bit register Rd and the carry and half-carry flags, the DAA instruction adjusts the contents of the 8-bit register Rd (destination operand) by adding H'00, H'06, H'60, or H'66 according to the table below.

C Flag before Adjustment	Upper 4 Bits before Adjustment	H Flag before Adjustment	Lower 4 Bits before Adjustment	Value Added (Hexadecimal)	C Flag after Adjustment
0	0 to 9	0	0 to 9	00	0
0	0 to 8	0	A to F	06	0
0	0 to 9	1	0 to 3	06	0
0	A to F	0	0 to 9	60	1
0	9 to F	0	A to F	66	1
0	A to F	1	0 to 3	66	1
1	1 to 2	0	0 to 9	60	1
1	1 to 2	0	A to F	66	1
1	1 to 3	1	0 to 3	66	1

**Available Registers**

Rd: R0L to R7L, R0H to R7H

**Operand Format and Number of States Required for Execution**

Addressing Mode	Mnemonic	Operands	Instruction Format				No. of States
			1st byte	2nd byte	3rd byte	4th byte	
Register direct	DAA	Rd	0   F	0   rd			1

**Notes**

Valid results (8-bit register Rd contents and C, V, Z, N, and H flags) are not assured if this instruction is executed under conditions other than those described above.

## 2.2.25 DAS

### DAS (Decimal Adjust Subtract)

Decimal Adjust

#### Operation

Rd (decimal adjust) → Rd

#### Condition Code

I	UI	H	U	N	Z	V	C
—	—	*	—	↑	↑	*	0

#### Assembly-Language Format

DAS Rd

#### Operand Size

Byte

- H: Undetermined (no guaranteed value).
- N: Set to 1 if the adjusted result is negative; otherwise cleared to 0.
- Z: Set to 1 if the adjusted result is zero; otherwise cleared to 0.
- V: Undetermined (no guaranteed value).
- C: Previous value remains unchanged.

#### Description

Given that the result of a subtraction operation performed by a SUB.B, SUBX.B, or NEG.B instruction on 4-bit BCD data is contained in an 8-bit register Rd and the carry and half-carry flags, the DAS instruction adjusts the contents of the 8-bit register Rd (destination operand) by adding H'00, H'FA, H'A0, or H'9A according to the table below.

C Flag before Adjustment	Upper 4 Bits before Adjustment	H Flag before Adjustment	Lower 4 Bits before Adjustment	Value Added (Hexadecimal)	C Flag after Adjustment
0	0 to 9	0	0 to 9	00	0
0	0 to 8	1	6 to F	FA	0
1	7 to F	0	0 to 9	A0	1
1	6 to F	1	6 to F	9A	1

#### Available Registers

Rd: R0L to R7L, R0H to R7H

---

**Operand Format and Number of States Required for Execution**

Addressing Mode	Mnemonic	Operands	Instruction Format				No. of States
			1st byte	2nd byte	3rd byte	4th byte	
Register direct	DAS	Rd	1	F	0	rd	1

---

**Notes**

Valid results (8-bit register Rd contents and C, V, Z, N, and H flags) are not assured if this instruction is executed under conditions other than those described above.

## 2.2.26 (1) DEC (B)

### DEC (DECrement)

Decrement

#### Operation

Rd – 1 → Rd

#### Condition Code

I	UI	H	U	N	Z	V	C
—	—	—	—	↕	↕	↕	—

#### Assembly-Language Format

DEC.B Rd

- H: Previous value remains unchanged.  
N: Set to 1 if the result is negative; otherwise cleared to 0.  
Z: Set to 1 if the result is zero; otherwise cleared to 0.  
V: Set to 1 if an overflow occurs; otherwise cleared to 0.  
C: Previous value remains unchanged.

#### Operand Size

Byte

#### Description

This instruction decrements an 8-bit register Rd (destination operand) and stores the result in the 8-bit register Rd.

#### Available Registers

Rd: R0L to R7L, R0H to R7H

#### Operand Format and Number of States Required for Execution

Addressing Mode	Mnemonic	Operands	Instruction Format				No. of States
			1st byte	2nd byte	3rd byte	4th byte	
Register direct	DEC.B	Rd	1 A	0 rd			1

#### Notes

An overflow is caused by the operation H'80 – 1 → H'7F.



## 2.2.26 (2) DEC (W)

### DEC (DECrement)

Decrement

#### Operation

Rd - 1 → Rd  
Rd - 2 → Rd

#### Condition Code

I	UI	H	U	N	Z	V	C
—	—	—	—	↕	↕	↕	—

#### Assembly-Language Format

DEC.W #1, Rd  
DEC.W #2, Rd

#### Operand Size

Word

- H: Previous value remains unchanged.  
N: Set to 1 if the result is negative; otherwise cleared to 0.  
Z: Set to 1 if the result is zero; otherwise cleared to 0.  
V: Set to 1 if an overflow occurs; otherwise cleared to 0.  
C: Previous value remains unchanged.

#### Description

This instruction subtracts the immediate value 1 or 2 from the contents of a 16-bit register Rd (destination operand) and stores the result in the 16-bit register Rd.

#### Available Registers

Rd: R0 to R7, E0 to E7

#### Operand Format and Number of States Required for Execution

Addressing Mode	Mnemonic	Operands	Instruction Format				No. of States
			1st byte	2nd byte	3rd byte	4th byte	
Register direct	DEC.W	#1, Rd	1	B	5	rd	1
Register direct	DEC.W	#2, Rd	1	B	D	rd	1

#### Notes

An overflow is caused by the operations H'8000 - 1 → H'7FFF, H'8000 - 2 → H'7FFE, and H'8001 - 2 → H'7FFF.

**DEC (DECrement)****Decrement****Operation**

ERd – 1 → ERd

ERd – 2 → ERd

**Condition Code**

I	UI	H	U	N	Z	V	C
—	—	—	—	↕	↕	↕	—

**Assembly-Language Format**

DEC.L #1, ERd

DEC.L #2, ERd

**Operand Size**

Longword

- H: Previous value remains unchanged.  
 N: Set to 1 if the result is negative; otherwise cleared to 0.  
 Z: Set to 1 if the result is zero; otherwise cleared to 0.  
 V: Set to 1 if an overflow occurs; otherwise cleared to 0.  
 C: Previous value remains unchanged.

**Description**

This instruction subtracts the immediate value 1 or 2 from the contents of a 32-bit register ERd (destination operand) and stores the result in the 32-bit register ERd.

**Available Registers**

ERd: ER0 to ER7

**Operand Format and Number of States Required for Execution**

Addressing Mode	Mnemonic	Operands	Instruction Format				No. of States
			1st byte	2nd byte	3rd byte	4th byte	
Register direct	DEC.L	#1, ERd	1	B	7	0:erd	1
Register direct	DEC.L	#2, ERd	1	B	F	0:erd	1

**Notes**

An overflow is caused by the operations H'80000000 – 1 → H'7FFFFFFF, H'80000000 – 2 → H'7FFFFFFE, and H'80000001 – 2 → H'7FFFFFFF.

## 2.2.27 (1) DIVXS (B)

### DIVXS (DIVide eXtend as Signed)

Divide Signed

#### Operation

$Rd \div Rs \rightarrow Rd$

#### Condition Code

I	UI	H	U	N	Z	V	C
—	—	—	—	↕	↕	—	—

#### Assembly-Language Format

DIVXS.B Rs, Rd

H: Previous value remains unchanged.

N: Set to 1 if the quotient is negative; otherwise cleared to 0.

Z: Set to 1 if the divisor is zero; otherwise cleared to 0.

V: Previous value remains unchanged.

C: Previous value remains unchanged.

#### Operand Size

Byte

#### Description

This instruction divides the contents of a 16-bit register Rd (destination operand) by the contents of an 8-bit register Rs (source operand) and stores the result in the 16-bit register Rd. The division is signed. The operation performed is 16 bits  $\div$  8 bits  $\rightarrow$  8-bit quotient and 8-bit remainder. The quotient is placed in the lower 8 bits of Rd. The remainder is placed in the upper 8 bits of Rd. The sign of the remainder matches the sign of the dividend.

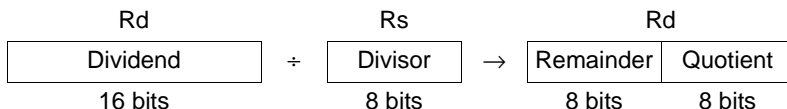

Valid results are not assured if division by zero is attempted or an overflow occurs.

#### Available Registers

Rd: R0 to R7, E0 to E7

Rs: R0L to R7L, R0H to R7H

---

**Operand Format and Number of States Required for Execution**

Addressing Mode	Mnemonic	Operands	Instruction Format								No. of States
			1st byte		2nd byte		3rd byte		4th byte		
Register direct	DIVXS.B	Rs, Rd	0	1	D	0	5	1	rs	rd	13

---

**Notes**

The N flag is set to 1 if the dividend and divisor have different signs, and cleared to 0 if they have the same sign. The N flag may therefore be set to 1 when the quotient is zero.

## 2.2.27 (2) DIVXS (W)

### DIVXS (DIVide eXtend as Signed)

Divide Signed

#### Operation

$ERd \div Rs \rightarrow ERd$

#### Condition Code

I	UI	H	U	N	Z	V	C
—	—	—	—	↕	↕	—	—

#### Assembly-Language Format

`DIVXS.W Rs, ERd`

H: Previous value remains unchanged.

N: Set to 1 if the quotient is negative; otherwise cleared to 0.

Z: Set to 1 if the divisor is zero; otherwise cleared to 0.

V: Previous value remains unchanged.

C: Previous value remains unchanged.

#### Operand Size

Word

#### Description

This instruction divides the contents of a 32-bit register ERd (destination operand) by the contents of a 16-bit register Rs (source operand) and stores the result in the 32-bit register ERd. The division is signed. The operation performed is 32 bits  $\div$  16 bits  $\rightarrow$  16-bit quotient and 16-bit remainder. The quotient is placed in the lower 16 bits (Rd) of the 32-bit register ERd. The remainder is placed in the upper 16 bits (Ed). The sign of the remainder matches the sign of the dividend.



Valid results are not assured if division by zero is attempted or an overflow occurs.

#### Available Registers

ERd: ER0 to ER7

Rs: R0 to R7, E0 to E7

**Operand Format and Number of States Required for Execution**

Addressing Mode	Mnemonic	Operands	Instruction Format								No. of States	
			1st byte		2nd byte		3rd byte		4th byte			
Register direct	DIVXS.W	Rs, ERd	0	1	D	0	5	3	rs	0	erd	21

**Notes**

The N flag is set to 1 if the dividend and divisor have different signs, and cleared to 0 if they have the same sign. The N flag may therefore be set to 1 when the quotient is zero.

## 2.2.28 (1) DIVXU (B)

**DIVXU (DIVide eXtend as Unsigned)**

**Divide**

### Operation

$Rd \div Rs \rightarrow Rd$

### Condition Code

I	UI	H	U	N	Z	V	C
—	—	—	—	↕	↕	—	—

### Assembly-Language Format

`DIVXU.B Rs, Rd`

H: Previous value remains unchanged.

N: Set to 1 if the divisor is negative; otherwise cleared to 0.

Z: Set to 1 if the divisor is zero; otherwise cleared to 0.

V: Previous value remains unchanged.

C: Previous value remains unchanged.

### Operand Size

Byte

### Description

This instruction divides the contents of a 16-bit register Rd (destination operand) by the contents of an 8-bit register Rs (source operand) and stores the result in the 16-bit register Rd. The division is unsigned. The operation performed is 16 bits  $\div$  8 bits  $\rightarrow$  8-bit quotient and 8-bit remainder. The quotient is placed in the lower 8 bits of Rd. The remainder is placed in the upper 8 bits of Rd.

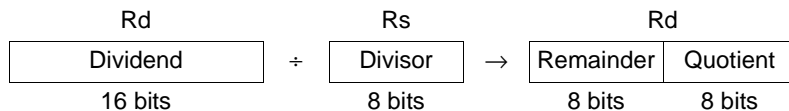

Valid results are not assured if division by zero is attempted or an overflow occurs.

### Available Registers

Rd: R0 to R7, E0 to E7

Rs: R0L to R7L, R0H to R7H

---

**Operand Format and Number of States Required for Execution**

Addressing Mode	Mnemonic	Operands	Instruction Format				No. of States	
			1st byte	2nd byte	3rd byte	4th byte		
Register direct	DIVXU.B	Rs, Rd	5	1	rs	rd		12

---

**Notes**



**Operation**

ERd ÷ Rs → ERd

**Condition Code**

I	UI	H	U	N	Z	V	C
—	—	—	—	↕	↕	—	—

**Assembly-Language Format**

DIVXU.W Rs, ERd

**Operand Size**

Word

H: Previous value remains unchanged.

N: Set to 1 if the divisor is negative; otherwise cleared to 0.

Z: Set to 1 if the divisor is zero; otherwise cleared to 0.

V: Previous value remains unchanged.

C: Previous value remains unchanged.

**Description**

This instruction divides the contents of a 32-bit register ERd (destination operand) by the contents of a 16-bit register Rs (source register) and stores the result in the 32-bit register ERd. The division is unsigned. The operation performed is 32 bits ÷ 16 bits → 16-bit quotient and 16-bit remainder. The quotient is placed in the lower 16 bits (Rd) of the 32-bit register ERd. The remainder is placed in the upper 16 bits of (Ed).

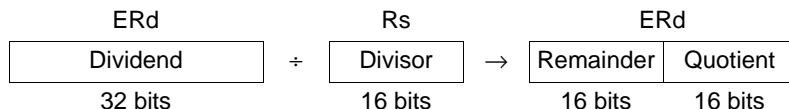

Valid results are not assured if division by zero is attempted or an overflow occurs.

**Available Registers**

ERd: ER0 to ER7

Rs: R0 to R7, E0 to E7

**Operand Format and Number of States Required for Execution**

Addressing Mode	Mnemonic	Operands	Instruction Format				No. of States
			1st byte	2nd byte	3rd byte	4th byte	
Register direct	DIVXU.W	Rs, ERd	5	3	rs	0:erd	20

**Notes**

**Operation**

if R4L  $\neq$  0 then  
 repeat @ER5+  $\rightarrow$  @ER6+  
     R4L - 1  $\rightarrow$  R4L  
 until R4L = 0  
 else next;

**Assembly-Language Format**

EEPMOV .B

**Condition Code**

I	UI	H	U	N	Z	V	C
—	—	—	—	—	—	—	—

H: Previous value remains unchanged.  
 N: Previous value remains unchanged.  
 Z: Previous value remains unchanged.  
 V: Previous value remains unchanged.  
 C: Previous value remains unchanged.

**Operand Size**

—

**Description**

This instruction performs a block data transfer. It moves data from the memory location specified in ER5 to the memory location specified in ER6, increments ER5 and ER6, decrements R4L, and repeats these operations until R4L reaches zero. Execution then proceeds to the next instruction. The data transfer is performed a byte at a time, with R4L indicating the number of bytes to be transferred. The byte symbol in the assembly-language format designates the size of R4L (and limits the maximum number of bytes that can be transferred to 255). No interrupts are detected while the block transfer is in progress.

When the EEPMOV.B instruction ends, R4L contains 0 (zero), and ER5 and ER6 contain the last transfer address + 1.

**Operand Format and Number of States Required for Execution**

Addressing Mode	Mnemonic	Operands	Instruction Format				No. of States
			1st byte	2nd byte	3rd byte	4th byte	
—	EEPMOV.B		7   B	5   C	5   9	8   F	4 + 2n*

Note: \* n is the initial value of R4L. Although n bytes of data are transferred, 2(n + 1) data accesses are performed, requiring 2(n + 1) states. (n = 0, 1, 2, ..., 255).

**Notes**

This instruction first reads the memory locations indicated by ER5 and ER6, then carries out the block data transfer.

**Operation**

if R4 ≠ 0 then  
 repeat @ER5+ → @ER6+  
     R4 - 1 → R4  
 until R4 = 0  
 else next;

**Assembly-Language Format**

EEPMOV.W

**Condition Code**

I	UI	H	U	N	Z	V	C
—	—	—	—	—	—	—	—

H: Previous value remains unchanged.  
 N: Previous value remains unchanged.  
 Z: Previous value remains unchanged.  
 V: Previous value remains unchanged.  
 C: Previous value remains unchanged.

**Operand Size**

—

**Description**

This instruction performs a block data transfer. It moves data from the memory location specified in ER5 to the memory location specified in ER6, increments ER5 and ER6, decrements R4, and repeats these operations until R4 reaches zero. Execution then proceeds to the next instruction. The data transfer is performed a byte at a time, with R4 indicating the number of bytes to be transferred. The word symbol in the assembly-language format designates the size of R4 (allowing a maximum 65535 bytes to be transferred). All interrupts are detected while the block transfer is in progress.

If no interrupt occurs while the EEPMOV.W instruction is executing, when the EEPMOV.W instruction ends, R4 contains 0 (zero), and ER5 and ER6 contain the last transfer address + 1.

If an interrupt occurs, interrupt exception handling begins after the current byte has been transferred. R4 indicates the number of bytes remaining to be transferred. ER5 and ER6 indicate the next transfer addresses. The program counter value pushed onto the stack in interrupt exception handling is the address of the next instruction after the EEPMOV.W instruction.

See the note on EEPMOV.W instruction and interrupt.

**Operand Format and Number of States Required for Execution**

Addressing Mode	Mnemonic	Operands	Instruction Format								No. of States
			1st byte		2nd byte		3rd byte		4th byte		
—	EPMOV.W		7	B	D	4	5	9	8	F	$4 + 2n^*$

Note: \* n is the initial value of R4. Although n bytes of data are transferred,  $2(n + 1)$  data accesses are performed, requiring  $2(n + 1)$  states. ( $n = 0, 1, 2, \dots, 65535$ ).

**Notes**

This instruction first reads memory at the addresses indicated by ER5 and ER6, then carries out the block data transfer.

**EPMOV.W Instruction and Interrupt**

If an interrupt request occurs while the EPMOV.W instruction is being executed, interrupt exception handling is carried out after the current byte has been transferred. Register contents are then as follows:

ER5: address of the next byte to be transferred

ER6: destination address of the next byte

R4: number of bytes remaining to be transferred

The program counter value pushed on the stack in interrupt exception handling is the address of the next instruction after the EPMOV.W instruction. Programs should be coded as follows to allow for interrupts during execution of the EPMOV.W instruction.

**Example:**

```
L1: EPMOV.W
      MOV.W    R4, R4
      BNE     L1
```

Interrupt requests other than NMI are not accepted if they are masked in the CPU.

During execution of the EPMOV.B instruction no interrupts are accepted, including NMI.

## 2.2.30 (1) EXTS (W)

### EXTS (EXTend as Signed)

### Sign Extension

#### Operation

(<Bit 7> of Rd) → (<bits 15 to 8> of Rd)

#### Condition Code

I	UI	H	U	N	Z	V	C
—	—	—	—	↕	↕	0	—

#### Assembly-Language Format

EXTS.W Rd

- H: Previous value remains unchanged.
- N: Set to 1 if the result is negative; otherwise cleared to 0.
- Z: Set to 1 if the result is zero; otherwise cleared to 0.
- V: Always cleared to 0.
- C: Previous value remains unchanged.

#### Operand Size

Word

#### Description

This instruction copies the sign of the lower 8 bits in a 16-bit register Rd in the upward direction (copies Rd bit 7 to bits 15 to 8) to extend the data to signed word data.

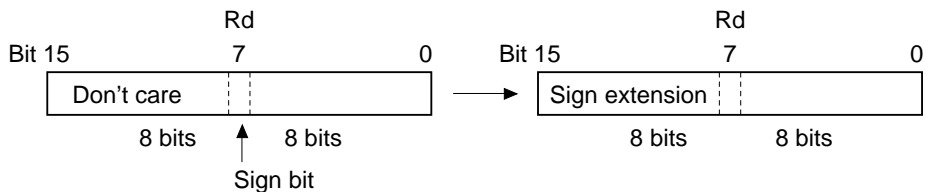

#### Available Registers

Rd: R0 to R7, E0 to E7

#### Operand Format and Number of States Required for Execution

Addressing Mode	Mnemonic	Operands	Instruction Format				No. of States
			1st byte	2nd byte	3rd byte	4th byte	
Register direct	EXTS.W	Rd	1	7	D	rd	1

#### Notes

## 2.2.30 (2) EXTS (L)

### EXTS (EXTend as Signed)

### Sign Extension

#### Operation

(<Bit 15> of ERd) → (<bits 31 to 16> of ERd)

#### Condition Code

I	UI	H	U	N	Z	V	C
—	—	—	—	↕	↕	0	—

#### Assembly-Language Format

EXTS .L ERd

- H: Previous value remains unchanged.
- N: Set to 1 if the result is negative; otherwise cleared to 0.
- Z: Set to 1 if the result is zero; otherwise cleared to 0.
- V: Always cleared to 0.
- C: Previous value remains unchanged.

#### Operand Size

Longword

#### Description

This instruction copies the sign of the lower 16 bits in a 32-bit register ERd in the upward direction (copies ERd bit 15 to bits 31 to 16) to extend the data to signed longword data.

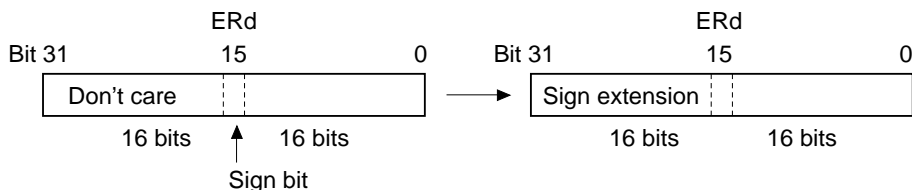

#### Available Registers

ERd: ER0 to ER7

#### Operand Format and Number of States Required for Execution

Addressing Mode	Mnemonic	Operands	Instruction Format				No. of States
			1st byte	2nd byte	3rd byte	4th byte	
Register direct	EXTS.L	ERd	1 7	F 0	erd		1

#### Notes

## 2.2.31 (1) EXTU (W)

### EXTU (EXTend as Unsigned)

### Zero Extension

#### Operation

0 → (<bits 15 to 8> of Rd)

#### Condition Code

I	UI	H	U	N	Z	V	C
—	—	—	—	0	↕	0	—

#### Assembly-Language Format

EXTU.W Rd

H: Previous value remains unchanged.

N: Always cleared to 0.

Z: Set to 1 if the result is zero; otherwise cleared to 0.

V: Always cleared to 0.

C: Previous value remains unchanged.

#### Operand Size

Word

#### Description

This instruction extends the lower 8 bits in a 16-bit register Rd to word data by padding with zeros. That is, it clears the upper 8 bits of Rd (bits 15 to 8) to 0.

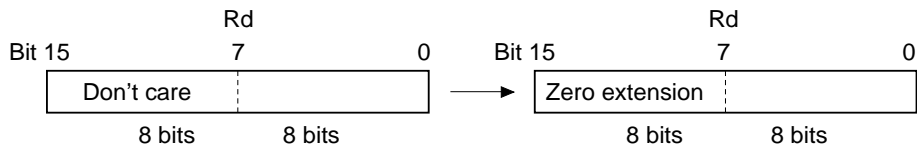

#### Available Registers

Rd: R0 to R7, E0 to E7

#### Operand Format and Number of States Required for Execution

Addressing Mode	Mnemonic	Operands	Instruction Format				No. of States
			1st byte	2nd byte	3rd byte	4th byte	
Register direct	EXTU.W	Rd	1   7	5   rd			1

#### Notes



## 2.2.31 (2) EXTU (L)

### EXTU (EXTend as Unsigned)

Zero Extension

#### Operation

0 → (<bits 31 to 16> of ERd)

#### Condition Code

I	UI	H	U	N	Z	V	C
—	—	—	—	0	↑	0	—

#### Assembly-Language Format

EXTU.L ERd

H: Previous value remains unchanged.

N: Always cleared to 0.

Z: Set to 1 if the result is zero; otherwise cleared to 0.

V: Always cleared to 0.

C: Previous value remains unchanged.

#### Operand Size

Longword

#### Description

This instruction extends the lower 16 bits (general register Rd) in a 32-bit register ERd to longword data by padding with zeros. That is, it clears the upper 16 bits of ERd (bits 31 to 16) to 0.

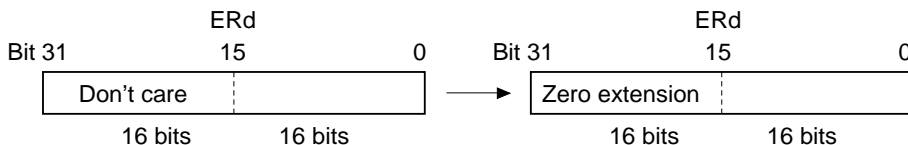

#### Available Registers

ERd: ER0 to ER7

#### Operand Format and Number of States Required for Execution

Addressing Mode	Mnemonic	Operands	Instruction Format				No. of States
			1st byte	2nd byte	3rd byte	4th byte	
Register direct	EXTU.L	ERd	1	7	7	0:erd	1

#### Notes

## 2.2.32 (1) INC (B)

### INC (INCRement)

Increment

#### Operation

Rd + 1 → Rd

#### Condition Code

I	UI	H	U	N	Z	V	C
—	—	—	—	↕	↕	↕	—

#### Assembly-Language Format

INC.B Rd

- H: Previous value remains unchanged.  
N: Set to 1 if the result is negative; otherwise cleared to 0.  
Z: Set to 1 if the result is zero; otherwise cleared to 0.  
V: Set to 1 if an overflow occurs; otherwise cleared to 0.  
C: Previous value remains unchanged.

#### Operand Size

Byte

#### Description

This instruction increments an 8-bit register Rd (destination operand) and stores the result in the 8-bit register Rd.

#### Available Registers

Rd: R0L to R7L, R0H to R7H

#### Operand Format and Number of States Required for Execution

Addressing Mode	Mnemonic	Operands	Instruction Format				No. of States
			1st byte	2nd byte	3rd byte	4th byte	
Register direct	INC.B	Rd	0 A	0 rd			1

#### Notes

An overflow is caused by the operation H'7F + 1 → H'80.

## 2.2.32 (2) INC (W)

### INC (INCRement)

Increment

#### Operation

Rd + 1 → Rd

Rd + 2 → Rd

#### Condition Code

I	UI	H	U	N	Z	V	C
—	—	—	—	↕	↕	↕	—

#### Assembly-Language Format

INC.W #1, Rd

INC.W #2, Rd

- H: Previous value remains unchanged.  
 N: Set to 1 if the result is negative; otherwise cleared to 0.  
 Z: Set to 1 if the result is zero; otherwise cleared to 0.  
 V: Set to 1 if an overflow occurs; otherwise cleared to 0.  
 C: Previous value remains unchanged.

#### Operand Size

Word

#### Description

This instruction adds the immediate value 1 or 2 to the contents of a 16-bit register Rd (destination operand) and stores the result in the 16-bit register Rd.

#### Available Registers

Rd: R0 to R7, E0 to E7

#### Operand Format and Number of States Required for Execution

Addressing Mode	Mnemonic	Operands	Instruction Format				No. of States	
			1st byte	2nd byte	3rd byte	4th byte		
Register direct	INC.W	#1, Rd	0	B	5	rd		1
Register direct	INC.W	#2, Rd	0	B	D	rd		1

#### Notes

An overflow is caused by the operations H'7FFF + 1 → H'8000, H'7FFF + 2 → H'8001, and H'7FFE + 2 → H'8000.

## 2.2.32 (3) INC (L)

### INC (INCRe ment)

Increment

#### Operation

ERd + 1 → ERd

ERd + 2 → ERd

#### Condition Code

I	UI	H	U	N	Z	V	C
—	—	—	—	↑	↓	↓	—

#### Assembly-Language Format

INC.L #1, ERd

INC.L #2, ERd

#### Operand Size

Longword

- H: Previous value remains unchanged.  
 N: Set to 1 if the result is negative; otherwise cleared to 0.  
 Z: Set to 1 if the result is zero; otherwise cleared to 0.  
 V: Set to 1 if an overflow occurs; otherwise cleared to 0.  
 C: Previous value remains unchanged.

#### Description

This instruction adds the immediate value 1 or 2 to the contents of a 32-bit register ERd (destination operand) and stores the result in the 32-bit register ERd.

#### Available Registers

ERd: ER0 to ER7

#### Operand Format and Number of States Required for Execution

Addressing Mode	Mnemonic	Operands	Instruction Format				No. of States
			1st byte	2nd byte	3rd byte	4th byte	
Register direct	INC.L	#1, ERd	0	B	7	0:erd	1
Register direct	INC.L	#2, ERd	0	B	F	0:erd	1

#### Notes

An overflow is caused by the operations H'7FFFFFFF + 1 → H'80000000, H'7FFFFFFF + 2 → H'80000001, and H'7FFFFFFE + 2 → H'80000000.

## 2.2.33 JMP

### JMP (JuMP)

### Unconditional Branch

#### Operation

Effective address → PC

#### Condition Code

I	UI	H	U	N	Z	V	C
—	—	—	—	—	—	—	—

#### Assembly-Language Format

JMP <EA>

- H: Previous value remains unchanged.
- N: Previous value remains unchanged.
- Z: Previous value remains unchanged.
- V: Previous value remains unchanged.
- C: Previous value remains unchanged.

#### Operand Size

—

#### Description

This instruction branches unconditionally to a specified effective address.

#### Available Registers

ERn: ER0 to ER7

#### Operand Format and Number of States Required for Execution

Addressing Mode	Mnemonic	Operands	Instruction Format				No. of States		
			1st byte	2nd byte	3rd byte	4th byte	Normal	Advanced	
Register indirect	JMP	@ERn	5	9	0;erm 0			2	
Absolute address	JMP	@aa:24	5	A	abs			3	
Memory indirect	JMP	@@aa:8	5	B	abs			4	5

#### Notes

The structure of the branch address and the number of states required for execution differ between normal mode and advanced mode.

Ensure that the branch destination address is even.

## 2.2.34 JSR

### JSR (Jump to SubRoutine)

### Jump to Subroutine

#### Operation

PC → @-SP

Effective address → PC

#### Condition Code

I	UI	H	U	N	Z	V	C
—	—	—	—	—	—	—	—

#### Assembly-Language Format

JSR <EA>

H: Previous value remains unchanged.

N: Previous value remains unchanged.

Z: Previous value remains unchanged.

V: Previous value remains unchanged.

C: Previous value remains unchanged.

#### Operand Size

—

#### Description

This instruction pushes the program counter onto the stack as a return address, then branches to a specified effective address. The program counter value pushed onto the stack is the address of the instruction following the JSR instruction.

#### Available Registers

ERn: ER0 to ER7

#### Operand Format and Number of States Required for Execution

Addressing Mode	Mnemonic	Operands	Instruction Format				No. of States	
			1st byte	2nd byte	3rd byte	4th byte	Normal	Advanced
Register indirect	JSR	@ERn	5	D 0:ern	0		3	4
Absolute address	JSR	@aa:24	5	E	abs		4	5
Memory indirect	JSR	@@aa:8	5	F	abs		4	6

**Notes**

The stack structure differs between normal mode and advanced mode. In normal mode only the lower 16 bits of the program counter are pushed onto the stack.

Ensure that the branch destination address is even.

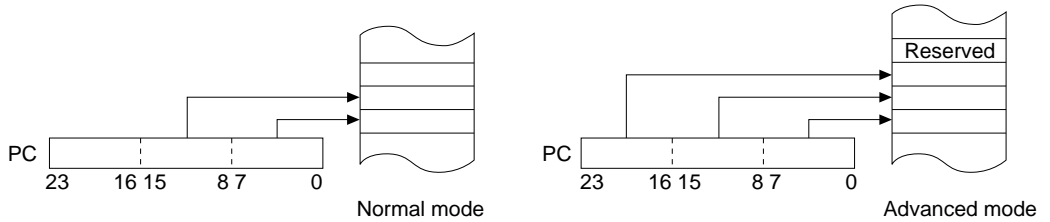

## 2.2.35 (1) LDC (B)

**LDC (Load to Control register)**

**Load CCR**

### Operation

<EAs> → CCR

### Condition Code

I	UI	H	U	N	Z	V	C
↕	↕	↕	↕	↕	↕	↕	↕

### Assembly-Language Format

LDC.B <EAs>, CCR

### Operand Size

Byte

- I: Loaded from the corresponding bit in the source operand.
- H: Loaded from the corresponding bit in the source operand.
- N: Loaded from the corresponding bit in the source operand.
- Z: Loaded from the corresponding bit in the source operand.
- V: Loaded from the corresponding bit in the source operand.
- C: Loaded from the corresponding bit in the source operand.

### Description

This instruction loads the source operand contents into the condition-code register (CCR).

No interrupt requests, including NMI, are accepted immediately after execution of this instruction.

### Available Registers

Rs: R0L to R7L, R0H to R7H

### Operand Format and Number of States Required for Execution

Addressing Mode	Mnemonic	Operands	Instruction Format				No. of States
			1st byte	2nd byte	3rd byte	4th byte	
Immediate	LDC.B	#xx:8, CCR	0	7	IMM		1
Register direct	LDC.B	Rs, CCR	0	3	0	rs	1

### Notes



## 2.2.35 (2) LDC (B)

LDC (LoaD to Control register)

Load EXR

### Operation

<EAs> → EXR

### Condition Code

I	UI	H	U	N	Z	V	C
—	—	—	—	—	—	—	—

### Assembly-Language Format

LDC . B <EAs>, EXR

H: Previous value remains unchanged.  
 N: Previous value remains unchanged.  
 Z: Previous value remains unchanged.  
 V: Previous value remains unchanged.  
 C: Previous value remains unchanged.

### Operand Size

Byte

### Description

This instruction loads the source operand contents into the extended control register (EXR).

No interrupt requests, including NMI, are accepted for three states after execution of this instruction.

### Available Registers

Rs: R0L to R7L, R0H to R7H

### Operand Format and Number of States Required for Execution

Addressing Mode	Mnemonic	Operands	Instruction Format				No. of States
			1st byte	2nd byte	3rd byte	4th byte	
Immediate	LDC.B	#xx:8, EXR	0   1	4   1	0   7	IMM	2
Register direct	LDC.B	Rs, EXR	0   3	1   rs			1

### Notes

## 2.2.35 (3) LDC (W)

**LDC (Load to Control register)**

**Load CCR**

---

### Operation

(EAs) → CCR

### Condition Code

I	UI	H	U	N	Z	V	C
↕	↕	↕	↕	↕	↕	↕	↕

---

### Assembly-Language Format

LDC.W <EAs>, CCR

---

### Operand Size

Word

- I: Loaded from the corresponding bit in the source operand.
- H: Loaded from the corresponding bit in the source operand.
- N: Loaded from the corresponding bit in the source operand.
- Z: Loaded from the corresponding bit in the source operand.
- V: Loaded from the corresponding bit in the source operand.
- C: Loaded from the corresponding bit in the source operand.

---

### Description

This instruction loads the source operand contents into the condition-code register (CCR).

Although CCR is a byte register, the source operand is word size. The contents of the even address are loaded into CCR.

No interrupt requests, including NMI, are accepted immediately after execution of this instruction.

---

### Available Registers

ERs: ER0 to ER7

**Operand Format and Number of States Required for Execution**

Addressing Mode	Mnemonic	Operands	Instruction Format										No. of States				
			1st byte	2nd byte	3rd byte	4th byte	5th byte	6th byte	7th byte	8th byte	9th byte	10th byte					
Register indirect	LDC.W	@ERs, CCR	0	1	4	0	6	9	0:ers	0							3
Register indirect with displacement	LDC.W	@(d:16, ERs), CCR	0	1	4	0	6	F	0:ers	0	disp						4
Register indirect with post-increment	LDC.W	@(d:32, ERs), CCR	0	1	4	0	7	8	0:ers	0	6	B	2	0	disp		6
Absolute address	LDC.W	@ERs+, CCR	0	1	4	0	6	D	0:ers	0							4
	LDC.W	@aa:16, CCR	0	1	4	0	6	B	0	0	abs						4
	LDC.W	@aa:32, CCR	0	1	4	0	6	B	2	0			abs				5

**Notes**

## 2.2.35 (4) LDC (W)

**LDC (Load to Control register)**

**Load EXR**

---

### Operation

(EAs) → EXR

### Condition Code

I	UI	H	U	N	Z	V	C
—	—	—	—	—	—	—	—

---

### Assembly-Language Format

LDC.W <EAs>, EXR

- H: Previous value remains unchanged.
- N: Previous value remains unchanged.
- Z: Previous value remains unchanged.
- V: Previous value remains unchanged.
- C: Previous value remains unchanged.

---

### Operand Size

Word

---

### Description

This instruction loads the source operand contents into the extended control register (EXR). Although EXR is a byte register, the source operand is word size. The contents of the even address are loaded into EXR.

No interrupt requests, including NMI, are accepted for three states after execution of this instruction.

---

### Available Registers

ERs: ER0 to ER7

Operand Format and Number of States Required for Execution

Addressing Mode	Mnemonic	Operands	Instruction Format										No. of States					
			1st byte	2nd byte	3rd byte	4th byte	5th byte	6th byte	7th byte	8th byte	9th byte	10th byte						
Register indirect	LDC.W	@ERs, EXR	0	1	4	1	6	9	0:ers	0								3
Register indirect with displacement	LDC.W	@(d:16, ERs), EXR	0	1	4	1	6	F	0:ers	0	disp							4
Register indirect with post-increment	LDC.W	@(d:32, ERs), EXR	0	1	4	1	7	8	0:ers	0	6	B	2	0	disp			6
Absolute address	LDC.W	@ERs+, EXR	0	1	4	1	6	D	0:ers	0								4
	LDC.W	@aa:16, EXR	0	1	4	1	6	B	0	0	abs							4
	LDC.W	@aa:32, EXR	0	1	4	1	6	B	2	0				abs				5

Notes

## 2.2.36 LDM

### LDM (LoaD to Multiple registers)

### Restore Data from Stack

---

#### Operation

@SP+ → ERn (register list)

#### Condition Code

I	UI	H	U	N	Z	V	C
—	—	—	—	—	—	—	—

---

#### Assembly-Language Format

LDM.L @SP+, <register list>

H: Previous value remains unchanged.

N: Previous value remains unchanged.

Z: Previous value remains unchanged.

V: Previous value remains unchanged.

C: Previous value remains unchanged.

---

#### Operand Size

Longword

---

#### Description

This instruction restores data saved on the stack to a specified list of registers. Registers are restored in descending order of register number.

Two, three, or four registers can be restored by one LDM instruction. The following ranges can be specified in the register list.

Two registers: ER0-ER1, ER2-ER3, ER4-ER5, or ER6-ER7

Three registers: ER0-ER2 or ER4-ER6

Four registers: ER0-ER3 or ER4-ER7

---

#### Available Registers

ERn: ER0 to ER7

---

**Operand Format and Number of States Required for Execution**

Addressing Mode	Mnemonic	Operands	Instruction Format								No. of States
			1st byte		2nd byte		3rd byte		4th byte		
—	LDM.L	@SP+, (ERn-ERn+1)	0	1	1	0	6	D	7	0:ern+1	7
—	LDM.L	@SP+, (ERn-ERn+2)	0	1	2	0	6	D	7	0:ern+2	9
—	LDM.L	@SP+, (ERn-ERn+3)	0	1	3	0	6	D	7	0:ern+3	11

---

**Notes**

## 2.2.37 LDMAC

### LDMAC (Load to MAC register)

### Load MAC Register

#### Operation

ERs → MACH  
or  
ERs → MACL

#### Condition Code

I	UI	H	U	N	Z	V	C
—	—	—	—	—	—	—	—

#### Assembly-Language Format

LDMAC ERs, MAC register

- H: Previous value remains unchanged.
- N: Previous value remains unchanged.
- Z: Previous value remains unchanged.
- V: Previous value remains unchanged.
- C: Previous value remains unchanged.

#### Operand Size

Longword

#### Description

This instruction moves the contents of a general register to a multiply-accumulate register (MACH or MACL). If the transfer is to MACH, only the lowest 10 bits of the general register are transferred.

Supported only by the H8S/2600 CPU.

#### Available Registers

ERs: ER0 to ER7

#### Operand Format and Number of States Required for Execution

Addressing Mode	Mnemonic	Operands	Instruction Format				No. of States
			1st byte	2nd byte	3rd byte	4th byte	
Register direct	LDMAC	ERs, MACH	0	3	2	0:ers	2*
Register direct	LDMAC	ERs, MACL	0	3	3	0:ers	2*

Note: \* A maximum of three additional states are required for execution of this instruction within three states after execution of a MAC instruction. For example, if there is a one-state instruction (such as NOP) between the MAC instruction and this instruction, this instruction will be two states longer.

#### Notes

Execution of this instruction clears the overflow flag in the multiplier to 0.



## 2.2.38 MAC

### MAC (Multiply and Accumulate)

### Multiply and Accumulate

---

#### Operation

$(EAn) \times (EAm) + \text{MAC register} \rightarrow$

MAC register

$ERn + 2 \rightarrow ERn$

$ERm + 2 \rightarrow ERm$

---

#### Assembly-Language Format

MAC @ERn+, @ERm+

#### Condition Code

I	UI	H	U	N	Z	V	C
—	—	—	—	—*	—*	—*	—

H: Previous value remains unchanged.

N: Previous value remains unchanged.

Z: Previous value remains unchanged.

V: Previous value remains unchanged.

C: Previous value remains unchanged.

---

#### Operand Size

—

---

#### Description

This instruction performs signed multiplication on two 16-bit operands at addresses given by the contents of general registers ERn and ERm, adds the 32-bit product to the contents of the MAC register, and stores the sum in the MAC register. After this operation, ERn and ERm are both incremented by 2.

The operation can be carried out in saturating or non-saturating mode, depending on the MACS bit in a system control register. (SYSCR)

See the relevant hardware manual for further information.

In non-saturating mode, MACH and MACL are concatenated to store a 42-bit result. The value of bit 41 is copied into the upper 22 bits of MACH as a sign extension.

In saturating mode, only MACL is valid, and the result is limited to the range from H'80000000 (minimum value) to H'7FFFFFFF (maximum value). If the result overflows in the negative direction, H'80000000 (the minimum value) is stored in MACL. If the result overflows in the positive direction, H'7FFFFFFF (the maximum value) is stored in MACL. The LSB of the MACH register indicates the status of the overflow flag (V-MULT) in the multiplier. Other bits retain their previous contents.

This instruction is supported only by the H8S/2600 CPU.

---

**Operand Format and Number of States Required for Execution**

Addressing Mode	Mnemonic	Operands	Instruction Format								No. of States		
			1st byte		2nd byte		3rd byte		4th byte				
Register indirect with post-increment	MAC	@ERn+, @ERm+	0	1	6	0	6	D	0	ern	0	erm	4

---

**Notes**

- Flags (N, Z, V) indicating the result of the MAC instruction can be set in the condition-code register (CCR) by the STMAC instruction.
- If ERn and ERm are the same register, the execution addresses are ERn and ERn + 2. After execution, the value of ERn is ERn + 4.
- If MACS is modified during execution of a MAC instruction, the result cannot be guaranteed. It is essential to wait for at least three states after a MAC instruction before modifying MACS.

---

**Further Explanation of Instructions Using Multiplier**

- Modification of flags

The multiplier has N-MULT, Z-MULT, and V-MULT flags that indicate the results of MAC instructions. These flags are separated from the condition-code register (CCR). The values of these flags can be set in the N, Z, and V flags of the CCR only by the STMAC instruction.

N-MULT and Z-MULT are modified only by MAC instructions. V-MULT retains a value indicating whether an overflow has occurred in the past, until it is cleared by execution of the CLRMAC or LDMAC instruction.

The setting and clearing conditions for these flags are given below.

- N-MULT (negative flag)

Saturating mode	Set when bit 31 of register MACL is set to 1 by execution of a MAC instruction
	Cleared when bit 31 of register MACL is cleared to 0 by execution of a MAC instruction
Non-saturating mode	Set when bit 41 of register MACH is set to 1 by execution of a MAC instruction
	Cleared when bit 41 of register MACH is cleared to 0 by execution of a MAC instruction

- Z-MULT (zero flag)

Saturating mode	Set when register MACL is cleared to 0 by execution of a MAC instruction
	Cleared when register MACL is not cleared to 0 by execution of a MAC instruction
Non-saturating mode	Set when registers MACH and MACL are both cleared to 0 by execution of a MAC instruction
	Cleared when register MACH or MACL is not cleared to 0 by execution of a MAC instruction

- V-MULT (overflow flag)

Saturating mode	Set when the result of the MAC instruction overflows the range from H'80000000 (minimum) to H'7FFFFFFF (maximum)
	Cleared when a CLRMAC or LDMAC instruction is executed Note: Not cleared when the result of the MAC instruction is within the above range
Non-saturating mode	Set when the result of the MAC instruction overflows the range from H'2000000000 (minimum) to H'1FFFFFFFFF (maximum)
	Cleared when a CLRMAC or LDMAC instruction is executed Note: Not cleared when the result of the MAC instruction is within the above range

The N-MULT, Z-MULT, and V-MULT flags are not modified by switching between saturating and non-saturating modes, or by execution of a multiply instruction (MULXU or MULXS).

2. Example

```

CLRMAC
MAC    @ER1+, @ER2+
MAC    @ER1+, @ER2+ ←—— Overflow occurs
:
MAC    @ER1+, @ER2+ ←—— Result = 0
NOP
STMAC  MACH, ER3    ←—— CCR (N = 0, Z = 1, V = 1)
CLRMAC
STMAC  MACH, ER3    ←—— CCR (N = 0, Z = 1, V = 0)
    
```

## 2.2.39 (1) MOV (B)

### MOV (MOVE data)

Move

#### Operation

Rs → Rd

#### Condition Code

I	UI	H	U	N	Z	V	C
—	—	—	—	↑	↓	0	—

#### Assembly-Language Format

MOV.B Rs, Rd

- H: Previous value remains unchanged.  
N: Set to 1 if the transferred data is negative; otherwise cleared to 0.  
Z: Set to 1 if the transferred data is zero; otherwise cleared to 0.  
V: Always cleared to 0.  
C: Previous value remains unchanged.

#### Operand Size

Byte

#### Description

This instruction transfers one byte of data from an 8-bit register Rs to an 8-bit register Rd, tests the transferred data, and sets condition-code flags according to the result.

#### Available Registers

Rs: R0L to R7L, R0H to R7H

Rd: R0L to R7L, R0H to R7H

#### Operand Format and Number of States Required for Execution

Addressing Mode	Mnemonic	Operands	Instruction Format				No. of States
			1st byte	2nd byte	3rd byte	4th byte	
Register direct	MOV.B	Rs, Rd	0	C	rs	rd	1

#### Notes

## 2.2.39 (2) MOV (W)

### MOV (MOVE data)

Move

#### Operation

Rs → Rd

#### Condition Code

I	UI	H	U	N	Z	V	C
—	—	—	—	↕	↕	0	—

#### Assembly-Language Format

MOV.W Rs, Rd

- H: Previous value remains unchanged.  
N: Set to 1 if the transferred data is negative; otherwise cleared to 0.  
Z: Set to 1 if the transferred data is zero; otherwise cleared to 0.  
V: Always cleared to 0.  
C: Previous value remains unchanged.

#### Operand Size

Word

#### Description

This instruction transfers one word of data from a 16-bit register Rs to a 16-bit register Rd, tests the transferred data, and sets condition-code flags according to the result.

#### Available Registers

Rd: R0 to R7, E0 to E7

Rs: R0 to R7, E0 to E7

#### Operand Format and Number of States Required for Execution

Addressing Mode	Mnemonic	Operands	Instruction Format				No. of States
			1st byte	2nd byte	3rd byte	4th byte	
Register direct	MOV.W	Rs, Rd	0 D	rs rd			1

#### Notes

## 2.2.39 (3) MOV (L)

### MOV (MOVE data)

Move

#### Operation

ERs → ERd

#### Condition Code

I	UI	H	U	N	Z	V	C
—	—	—	—	↑	↓	0	—

#### Assembly-Language Format

MOV.L ERs, ERd

- H: Previous value remains unchanged.  
N: Set to 1 if the transferred data is negative; otherwise cleared to 0.  
Z: Set to 1 if the transferred data is zero; otherwise cleared to 0.  
V: Always cleared to 0.  
C: Previous value remains unchanged.

#### Operand Size

Longword

#### Description

This instruction transfers one word of data from a 32-bit register ERs to a 32-bit register ERd, tests the transferred data, and sets condition-code flags according to the result.

#### Available Registers

ERd: ER0 to ER7

ERs: ER0 to ER7

#### Operand Format and Number of States Required for Execution

Addressing Mode	Mnemonic	Operands	Instruction Format				No. of States
			1st byte	2nd byte	3rd byte	4th byte	
Register direct	MOV.L	ERs, ERd	0	F	1ers0erd		1

#### Notes

## 2.2.39 (4) MOV (B)

### MOV (MOVE data)

Move

---

#### Operation

(EAs) → Rd

#### Condition Code

I	UI	H	U	N	Z	V	C
—	—	—	—	↕	↕	0	—

---

#### Assembly-Language Format

MOV .B <EAs>, Rd

- H: Previous value remains unchanged.  
N: Set to 1 if the transferred data is negative; otherwise cleared to 0.  
Z: Set to 1 if the transferred data is zero; otherwise cleared to 0.  
V: Always cleared to 0.  
C: Previous value remains unchanged.

---

#### Operand Size

Byte

---

#### Description

This instruction transfers the source operand contents to an 8-bit register Rd, tests the transferred data, and sets condition-code flags according to the result.

---

#### Available Registers

Rd: R0L to R7L, R0H to R7H

ERs: ER0 to ER7

## Operand Format and Number of States Required for Execution

Addressing Mode	Mnemonic	Operands	Instruction Format								No. of States			
			1st byte	2nd byte	3rd byte	4th byte	5th byte	6th byte	7th byte	8th byte				
Immediate	MOV.B	#xx:8, Rd	F	rd	IMM									1
Register indirect	MOV.B	@ERs, Rd	6	8	0	ers	rd							2
Register indirect with displacement	MOV.B	@(d:16, ERs), Rd	6	E	0	ers	rd	disp						3
Register indirect with post-increment	MOV.B	@(d:32, ERs), Rd	7	8	0	ers	0	6	A	2	rd	disp		5
Absolute address	MOV.B	@aa:8, Rd	2	rd	abs									2
	MOV.B	@aa:16, Rd	6	A	0	rd	abs							3
	MOV.B	@aa:32, Rd	6	A	2	rd	abs							4

## Notes

The MOV.B @ER7+, Rd instruction should never be used, because it leaves an odd value in the stack pointer (ER7). For details refer to section 3.3, Exception-Handling State, or to the relevant hardware manual.

For the @aa:8/@aa:16 access range, refer to the relevant microcontroller hardware manual.



## 2.2.39 (5) MOV (W)

### MOV (MOVE data)

Move

---

#### Operation

(EAs) → Rd

#### Condition Code

I	UI	H	U	N	Z	V	C
—	—	—	—	↕	↕	0	—

---

#### Assembly-Language Format

MOV .w <EAs>, Rd

- H: Previous value remains unchanged.  
N: Set to 1 if the transferred data is negative; otherwise cleared to 0.  
Z: Set to 1 if the transferred data is zero; otherwise cleared to 0.  
V: Always cleared to 0.  
C: Previous value remains unchanged.

---

#### Operand Size

Word

---

#### Description

This instruction transfers the source operand contents to a 16-bit register Rd, tests the transferred data, and sets condition-code flags according to the result.

---

#### Available Registers

Rd: R0 to R7, E0 to E7

ERs: ER0 to ER7

## Operand Format and Number of States Required for Execution

Addressing Mode	Mnemonic	Operands	Instruction Format								No. of States		
			1st byte	2nd byte	3rd byte	4th byte	5th byte	6th byte	7th byte	8th byte			
Immediate	MOVW	#xx:16, Rd	7	9	0	rd	IMM						2
Register indirect	MOVW	@ERs, Rd	6	9	0	ers	rd						2
Register indirect with displacement	MOVW	@(d:16, ERs), Rd	6	F	0	ers	rd	disp					3
Register indirect with post-increment	MOVW	@(d:32, ERs), Rd	7	8	0	ers	0	6	B	2	rd	disp	5
Absolute address	MOVW	@ERs+, Rd	6	D	0	ers	rd						3
	MOVW	@aa:16, Rd	6	B	0	rd		abs					3
	MOVW	@aa:32, Rd	6	B	2	rd		abs					4

## Notes

1. The source operand <EAs> must be located at an even address.
2. In machine language, MOV.W @ER7+, Rd is identical to POP.W Rd.

## 2.2.39 (6) MOV (L)

### MOV (MOVE data)

Move

#### Operation

(EAs) → ERd

#### Condition Code

I	UI	H	U	N	Z	V	C
—	—	—	—	↕	↕	0	—

#### Assembly-Language Format

MOV .L <EAs>, ERd

- H: Previous value remains unchanged.
- N: Set to 1 if the transferred data is negative; otherwise cleared to 0.
- Z: Set to 1 if the transferred data is zero; otherwise cleared to 0.
- V: Always cleared to 0.
- C: Previous value remains unchanged.

#### Operand Size

Longword

#### Description

This instruction transfers the source operand contents to a specified 32-bit register (ERd), tests the transferred data, and sets condition-code flags according to the result. The first memory word located at the effective address is stored in extended register Ed. The next word is stored in general register Rd.

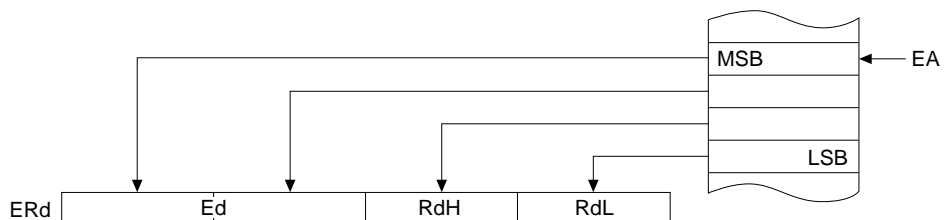

#### Available Registers

ERs: ER0 to ER7

ERd: ER0 to ER7

Operand Format and Number of States Required for Execution

Addressing Mode	Mnemonic	Operands	Instruction Format										No. of States		
			1st byte	2nd byte	3rd byte	4th byte	5th byte	6th byte	7th byte	8th byte	9th byte	10th byte			
Immediate	MOV.L	#xx:32, Rd	7	A	0	0:0:erd	IMM								3
Register indirect	MOV.L	@ERs, ERd	0	1	0	0	6	9	0:ers:0:erd						4
Register indirect with displacement	MOV.L	@(d:16, ERs), ERd	0	1	0	0	6	F	0:ers:0:erd	disp					5
Register indirect with post-increment	MOV.L	@(d:32, ERs), ERd	0	1	0	0	7	8	0:ers	0	6	2	0:erd	disp	7
Register indirect with post-increment	MOV.L	@ERs+, ERd	0	1	0	0	6	D	0:ers:0:erd						5
Absolute address	MOV.L	@aa:16, ERd	0	1	0	0	6	B	0	0:0:erd	abs				5
	MOV.L	@aa:32, ERd	0	1	0	0	6	B	2	0:erd	abs				6

Notes

1. The source operand <EAs> must be located at an even address.
2. In machine language, MOV.L @R7+, ERd is identical to POPL ERd.

## 2.2.39 (7) MOV (B)

### MOV (MOVE data)

Move

---

#### Operation

Rs → (EAd)

#### Condition Code

I	UI	H	U	N	Z	V	C
—	—	—	—	↕	↕	0	—

---

#### Assembly-Language Format

MOV .B Rs, <EAd>

- H: Previous value remains unchanged.  
N: Set to 1 if the transferred data is negative; otherwise cleared to 0.  
Z: Set to 1 if the transferred data is zero; otherwise cleared to 0.  
V: Always cleared to 0.  
C: Previous value remains unchanged.

---

#### Operand Size

Byte

---

#### Description

This instruction transfers the contents of an 8-bit register Rs (source operand) to a destination location, tests the transferred data, and sets condition-code flags according to the result.

---

#### Available Registers

Rs: R0L to R7L, R0H to R7H

ERd: ER0 to ER7

## Operand Format and Number of States Required for Execution

Addressing Mode	Mnemonic	Operands	Instruction Format								No. of States			
			1st byte	2nd byte	3rd byte	4th byte	5th byte	6th byte	7th byte	8th byte				
Register indirect	MOV/B	Rs, @ERd	6	8	1:erd	rs								2
Register indirect with displacement	MOV/B	Rs, @({d:16, ERd})	6	E	1:erd	rs	disp							3
Register indirect with pre-decrement	MOV/B	Rs, @({d:32, ERd})	7	8	0:erd	0	6	A	A	rs	disp			5
Register indirect with pre-decrement	MOV/B	Rs, @-ERd	6	C	1:erd	rs								3
Absolute address	MOV/B	Rs, @aa:8	3	rs	abs									2
	MOV/B	Rs, @aa:16	6	A	8	rs	abs							3
	MOV/B	Rs, @aa:32	6	A	A	rs	abs							4

## Notes

1. The MOV.B Rs, @-ER7 instruction should never be used, because it leaves an odd value in the stack pointer (ER7). For details refer to section 3.3, Exception-Handling State, or to the relevant hardware manual.
2. Execution of MOV.B RnL, @-ERn or MOV.B RnH, @-ERn first decrements ERn by one, then transfers the designated part (RnL or RnH) of the resulting ERn value.

## 2.2.39 (8) MOV (W)

### MOV (MOVE data)

Move

---

#### Operation

Rs → (EAd)

#### Condition Code

I	UI	H	U	N	Z	V	C
—	—	—	—	↕	↕	0	—

---

#### Assembly-Language Format

MOV.W Rs, <EAd>

- H: Previous value remains unchanged.  
N: Set to 1 if the transferred data is negative; otherwise cleared to 0.  
Z: Set to 1 if the transferred data is zero; otherwise cleared to 0.  
V: Always cleared to 0.  
C: Previous value remains unchanged.

---

#### Operand Size

Word

---

#### Description

This instruction transfers the contents of a 16-bit register Rs (source operand) to a destination location, tests the transferred data, and sets condition-code flags according to the result.

---

#### Available Registers

Rs: R0 to R7, E0 to E7

ERd: ER0 to ER7

## Operand Format and Number of States Required for Execution

Addressing Mode	Mnemonic	Operands	Instruction Format								No. of States		
			1st byte	2nd byte	3rd byte	4th byte	5th byte	6th byte	7th byte	8th byte			
Register indirect	MOV.W	Rs, @ERd	6	9	1:erd	rs							2
Register indirect with displacement	MOV.W	Rs, @(d:16, ERd)	6	F	1:erd	rs	disp						3
Register indirect with pre-decrement	MOV.W	Rs, @(d:32, ERd)	7	8	0:erd	0	6	B	A	rs	disp		5
Register indirect with pre-decrement	MOV.W	Rs, @-ERd	6	D	1:erd	rs							3
Absolute address	MOV.W	Rs, @aa:16	6	B	8	rs	abs						3
	MOV.W	Rs, @aa:32	6	B	A	rs	abs						4

## Notes

1. The destination operand <EAd> must be located at an even address.
2. In machine language, MOV.W Rs, @-ER7 is identical to PUSH.W Rs.
3. When MOV.W Rn, @-ERn is executed, the transferred value comes from (value of ERn before execution) – 2.



## 2.2.39 (9) MOV (L)

### MOV (MOVE data)

Move

#### Operation

ERs → (EAd)

#### Condition Code

I	UI	H	U	N	Z	V	C
—	—	—	—	↕	↕	0	—

#### Assembly-Language Format

MOV .L ERs, <EAd>

- H: Previous value remains unchanged.
- N: Set to 1 if the transferred data is negative; otherwise cleared to 0.
- Z: Set to 1 if the transferred data is zero; otherwise cleared to 0.
- V: Always cleared to 0.
- C: Previous value remains unchanged.

#### Operand Size

Longword

#### Description

This instruction transfers the contents of a 32-bit register ERs (source operand) to a destination location, tests the transferred data, and sets condition-code flags according to the result. The extended register (Es) contents are stored at the first word indicated by the effective address. The general register (Rs) contents are stored at the next word.

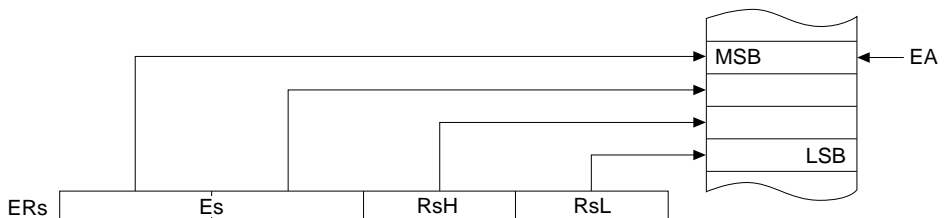

#### Available Registers

ERs: ER0 to ER7

ERd: ER0 to ER7

## Operand Format and Number of States Required for Execution

Addressing Mode	Mnemonic	Operands	Instruction Format										No. of States				
			1st byte	2nd byte	3rd byte	4th byte	5th byte	6th byte	7th byte	8th byte	9th byte	10th byte					
Register indirect	MOV.L	ERs, @ERd	0	1	0	0	6	9	1	erd;0;ers							4
Register indirect with displacement	MOV.L	ERs, @(d;16; ERd)	0	1	0	0	6	F	1;erd;0;ers	disp							5
Register indirect with pre-increment	MOV.L	ERs, @(d;32; ERd)	0	1	0	0	7	8	0;erd;0	6	B	A	0;ers	disp			7
Register indirect with pre-decrement	MOV.L	ERs, @-ERd	0	1	0	0	6	D	1;erd;0;ers								5
Absolute address	MOV.L	ERs, @aa;16	0	1	0	0	6	B	8	0;ers	abs						5
	MOV.L	ERs, @aa;32	0	1	0	0	6	B	A	0;ers	abs						6

## Notes

1. The destination operand <EAd> must be located at an even address.
2. In machine language, MOV.L ERs, @-ER7 is identical to PUSH.L ERs.
3. When MOV.L ERn, @-ERn is executed, the transferred value is (value of ERn before execution) – 4.

## 2.2.40 MOVFPE

### MOVFPE (MOVE From Peripheral with E clock)

### Move Data with E Clock

#### Operation

(EAs) → Rd  
Synchronized with E clock

#### Condition Code

I	UI	H	U	N	Z	V	C
—	—	—	—	↕	↕	0	—

#### Assembly-Language Format

MOVFPE @aa:16, Rd

- H: Previous value remains unchanged.  
N: Set to 1 if the transferred data is negative; otherwise cleared to 0.  
Z: Set to 1 if the transferred data is zero; otherwise cleared to 0.  
V: Always cleared to 0.  
C: Previous value remains unchanged.

#### Operand Size

Byte

#### Description

This instruction transfers memory contents specified by a 16-bit absolute address to a general register Rd in synchronization with an E clock, tests the transferred data, and sets condition-code flags according to the result.

Note: Avoid using this instruction in microcontrollers without an E clock output pin, or in single-chip mode.

#### Available Registers

Rd: R0L to R7L, R0H to R7H

#### Operand Format and Number of States Required for Execution

Addressing Mode	Mnemonic	Operands	Instruction Format				No. of States
			1st byte	2nd byte	3rd byte	4th byte	
Absolute address	MOVFPE	@aa:16, Rd	6 A	4 rd	abs		*

Note: \* For details, refer to the relevant microcontroller hardware manual.

#### Notes

1. This instruction cannot be used with addressing modes other than the above, and cannot transfer word data or longword data.
2. The number of states required for execution is variable. For details, refer to the relevant microcontroller hardware manual.

## 2.2.41 MOVTPPE

### MOVTPPE (MOVE To Peripheral with E clock)

### Move Data with E Clock

#### Operation

Rs → (EAd)

Synchronized with E clock

#### Condition Code

I	UI	H	U	N	Z	V	C
—	—	—	—	↑	↓	0	—

#### Assembly-Language Format

MOVTPPE Rs, @aa:16

H: Previous value remains unchanged.

N: Set to 1 if the transferred data is negative; otherwise cleared to 0.

Z: Set to 1 if the transferred data is zero; otherwise cleared to 0.

V: Always cleared to 0.

C: Previous value remains unchanged.

#### Operand Size

Byte

#### Description

This instruction transfers the contents of a general register Rs (source operand) to a destination location specified by a 16-bit absolute address in synchronization with an E clock, tests the transferred data, and sets condition-code flags according to the result.

Note: Avoid using this instruction in microcontrollers without an E clock output pin, or in single-chip mode.

#### Available Registers

Rs: R0L to R7L, R0H to R7H

#### Operand Format and Number of States Required for Execution

Addressing Mode	Mnemonic	Operands	Instruction Format				No. of States	
			1st byte	2nd byte	3rd byte	4th byte		
Absolute address	MOVTPPE	Rs, @aa:16	6	A	C	rs	abs	*

Note: \* For details, refer to the relevant microcontroller hardware manual.

#### Notes

1. This instruction cannot be used with addressing modes other than the above, and cannot transfer word data or longword data.
2. The number of states required for execution is variable. For details, refer to the relevant microcontroller hardware manual.

## 2.2.42 (1) MULXS (B)

### MULXS (MULtipleY eXtend as Signed)

Multiply Signed

#### Operation

$Rd \times Rs \rightarrow Rd$

#### Condition Code

I	UI	H	U	N	Z	V	C
—	—	—	—	↕	↕	—	—

#### Assembly-Language Format

MULXS.B Rs, Rd

- H: Previous value remains unchanged.  
 N: Set to 1 if the result is negative; otherwise cleared to 0.  
 Z: Set to 1 if the result is zero; otherwise cleared to 0.  
 V: Previous value remains unchanged.  
 C: Previous value remains unchanged.

#### Operand Size

Byte

#### Description

This instruction multiplies the lower 8 bits of a 16-bit register Rd (destination operand) by the contents of an 8-bit register Rs (source operand) as signed data and stores the result in the 16-bit register Rd. If Rd is one of general registers R0 to R7, Rs can be the upper part (RdH) or lower part (RdL) of Rd. The operation performed is 8 bits  $\times$  8 bits  $\rightarrow$  16 bits signed multiplication.

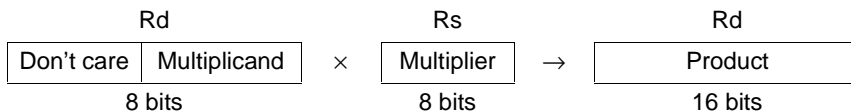

#### Available Registers

Rd: R0 to R7, E0 to E7

Rs: R0L to R7L, R0H to R7H

#### Operand Format and Number of States Required for Execution

Addressing Mode	Mnemonic	Operands	Instruction Format				No. of States
			1st byte	2nd byte	3rd byte	4th byte	
Register direct	MULXS.B	Rs, Rd	0   1	C   0	5   0	rs   rd	4*

Note: \* The number of states in the H8S/2000 CPU is 13.

A maximum of three additional states are required for execution of this instruction within three states after execution of a MAC instruction. For example, if there is a one-state instruction (such as NOP) between the MAC instruction and this instruction, this instruction will be two states longer.

#### Notes

## 2.2.42 (2) MULXS (W)

### MULXS (MULTIPLY eXtend as Signed)

Multiply Signed

#### Operation

$ERd \times Rs \rightarrow ERd$

#### Condition Code

I	UI	H	U	N	Z	V	C
—	—	—	—	↕	↕	—	—

#### Assembly-Language Format

MULXS.W Rs, ERd

- H: Previous value remains unchanged.  
 N: Set to 1 if the result is negative; otherwise cleared to 0.  
 Z: Set to 1 if the result is zero; otherwise cleared to 0.  
 V: Previous value remains unchanged.  
 C: Previous value remains unchanged.

#### Operand Size

Word

#### Description

This instruction multiplies the lower 16 bits of a 32-bit register ERd (destination operand) by the contents of a 16-bit register Rs (source operand) as signed data and stores the result in the 32-bit register ERd. Rs can be the upper part (Ed) or lower part (Rd) of ERd. The operation performed is 16 bits  $\times$  16 bits  $\rightarrow$  32 bits signed multiplication.

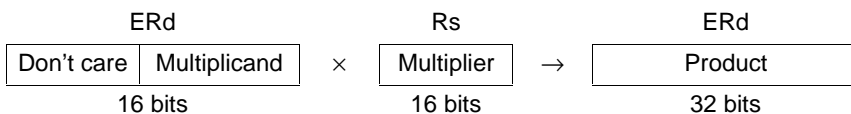

#### Available Registers

ERd: ER0 to ER7

Rs: R0 to R7, E0 to E7

#### Operand Format and Number of States Required for Execution

Addressing Mode	Mnemonic	Operands	Instruction Format				No. of States					
			1st byte	2nd byte	3rd byte	4th byte						
Register direct	MULXS.W	Rs, ERd	0	1	C	0	5	2	rs	0	erd	5*

Note: \* The number of states in the H8S/2000 CPU is 21.

A maximum of three additional states are required for execution of this instruction within three states after execution of a MAC instruction. For example, if there is a one-state instruction (such as NOP) between the MAC instruction and this instruction, this instruction will be two states longer.

#### Notes

## 2.2.43 (1) MULXU (B)

MULXU (MULTIply eXtend as Unsigned)

Multiply

### Operation

$Rd \times Rs \rightarrow Rd$

### Condition Code

I	UI	H	U	N	Z	V	C
—	—	—	—	—	—	—	—

### Assembly-Language Format

MULXU.B Rs, Rd

- H: Previous value remains unchanged.  
 N: Previous value remains unchanged.  
 Z: Previous value remains unchanged.  
 V: Previous value remains unchanged.  
 C: Previous value remains unchanged.

### Operand Size

Byte

### Description

This instruction multiplies the lower 8 bits of a 16-bit register Rd (destination operand) by the contents of an 8-bit register Rs (source operand) as unsigned data and stores the result in the 16-bit register Rd. If Rd is one of general registers R0 to R7, Rs can be the upper part (RdH) or lower part (RdL) of Rd. The operation performed is 8 bits  $\times$  8 bits  $\rightarrow$  16 bits unsigned multiplication.

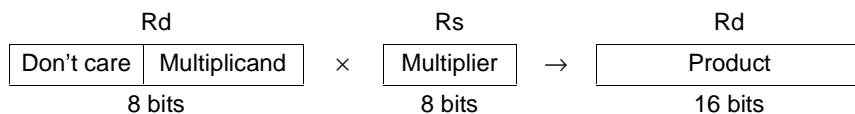

### Available Registers

Rd: R0 to R7, E0 to E7

Rs: R0L to R7L, R0H to R7H

### Operand Format and Number of States Required for Execution

Addressing Mode	Mnemonic	Operands	Instruction Format				No. of States
			1st byte	2nd byte	3rd byte	4th byte	
Register direct	MULXU.B	Rs, Rd	5	0	rs	rd	3*

Note: \* The number of states in the H8S/2000 CPU is 12.

A maximum of three additional states are required for execution of this instruction within three states after execution of a MAC instruction. For example, if there is a one-state instruction (such as NOP) between the MAC instruction and this instruction, this instruction will be two states longer.

### Notes

## 2.2.43 (2) MULXU (W)

### MULXU (MULTIPLY eXtend as Unsigned)

Multiply

#### Operation

$ERd \times Rs \rightarrow ERd$

#### Condition Code

I	UI	H	U	N	Z	V	C
—	—	—	—	—	—	—	—

#### Assembly-Language Format

MULXU.W Rs, ERd

H: Previous value remains unchanged.

N: Previous value remains unchanged.

Z: Previous value remains unchanged.

V: Previous value remains unchanged.

C: Previous value remains unchanged.

#### Operand Size

Word

#### Description

This instruction multiplies the lower 16 bits of a 32-bit register ERd (destination operand) by the contents of a 16-bit register Rs (source operand) as unsigned data and stores the result in the 32-bit register ERd. Rs can be the upper part (Ed) or lower part (Rd) of ERd. The operation performed is 16 bits  $\times$  16 bits  $\rightarrow$  32 bits unsigned multiplication.

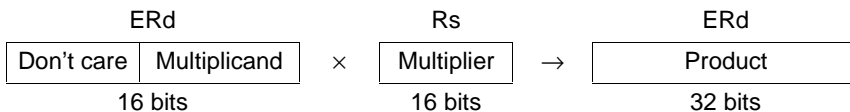

#### Available Registers

ERd: ER0 to ER7

Rs: R0 to R7, E0 to E7

#### Operand Format and Number of States Required for Execution

Addressing Mode	Mnemonic	Operands	Instruction Format				No. of States
			1st byte	2nd byte	3rd byte	4th byte	
Register direct	MULXU.W	Rs, ERd	5	2	rs	0:erd	4*

Note: \* The number of states in the H8S/2000 CPU is 20.

A maximum of three additional states are required for execution of this instruction within three states after execution of a MAC instruction. For example, if there is a one-state instruction (such as NOP) between the MAC instruction and this instruction, this instruction will be two states longer.

#### Notes



## 2.2.44 (1) NEG (B)

NEG (NEGate)

Negate Binary Signed

### Operation

0 – Rd → Rd

### Condition Code

I	UI	H	U	N	Z	V	C
—	—	↕	—	↕	↕	↕	↕

### Assembly-Language Format

NEG .B Rd

- H: Set to 1 if there is a borrow at bit 3; otherwise cleared to 0.
- N: Set to 1 if the result is negative; otherwise cleared to 0.
- Z: Set to 1 if the result is zero; otherwise cleared to 0.
- V: Set to 1 if an overflow occurs; otherwise cleared to 0.
- C: Set to 1 if there is a borrow at bit 7; otherwise cleared to 0.

### Operand Size

Byte

### Description

This instruction takes the two's complement of the contents of an 8-bit register Rd (destination operand) and stores the result in the 8-bit register Rd (subtracting the register contents from H'00). If the original contents of Rd were H'80, however, the result remains H'80.

### Available Registers

Rd: R0L to R7L, R0H to R7H

### Operand Format and Number of States Required for Execution

Addressing Mode	Mnemonic	Operands	Instruction Format				No. of States
			1st byte	2nd byte	3rd byte	4th byte	
Register direct	NEG.B	Rd	1   7	8   rd			1

### Notes

An overflow occurs if the original contents of Rd were H'80.

## 2.2.44 (2) NEG (W)

NEG (NEGate)

Negate Binary Signed

### Operation

0 – Rd → Rd

### Condition Code

I	UI	H	U	N	Z	V	C
—	—	↕	—	↕	↕	↕	↕

### Assembly-Language Format

NEG.W Rd

### Operand Size

Word

- H: Set to 1 if there is a borrow at bit 11; otherwise cleared to 0.
- N: Set to 1 if the result is negative; otherwise cleared to 0.
- Z: Set to 1 if the result is zero; otherwise cleared to 0.
- V: Set to 1 if an overflow occurs; otherwise cleared to 0.
- C: Set to 1 if there is a borrow at bit 15; otherwise cleared to 0.

### Description

This instruction takes the two's complement of the contents of a 16-bit register Rd (destination operand) and stores the result in the 16-bit register Rd (subtracting the register contents from H'0000). If the original contents of Rd were H'8000, however, the result remains H'8000.

### Available Registers

Rd: R0 to R7, E0 to E7

### Operand Format and Number of States Required for Execution

Addressing Mode	Mnemonic	Operands	Instruction Format				No. of States
			1st byte	2nd byte	3rd byte	4th byte	
Register direct	NEG.W	Rd	1   7	9   rd			1

### Notes

An overflow occurs if the original contents of Rd were H'8000.

## 2.2.44 (3) NEG (L)

NEG (NEGate)

Negate Binary Signed

### Operation

0 – ERd → ERd

### Condition Code

I	UI	H	U	N	Z	V	C
—	—	↕	—	↕	↕	↕	↕

### Assembly-Language Format

NEG.L ERd

- H: Set to 1 if there is a borrow at bit 27; otherwise cleared to 0.
- N: Set to 1 if the result is negative; otherwise cleared to 0.
- Z: Set to 1 if the result is zero; otherwise cleared to 0.
- V: Set to 1 if an overflow occurs; otherwise cleared to 0.
- C: Set to 1 if there is a borrow at bit 31; otherwise cleared to 0.

### Operand Size

Longword

### Description

This instruction takes the two's complement of the contents of a 32-bit register ERd (destination operand) and stores the result in the 32-bit register ERd (subtracting the register contents from H'00000000). If the original contents of ERd were H'80000000, however, the result remains H'80000000.

### Available Registers

ERd: ER0 to ER7

### Operand Format and Number of States Required for Execution

Addressing Mode	Mnemonic	Operands	Instruction Format				No. of States
			1st byte	2nd byte	3rd byte	4th byte	
Register direct	NEG.L	ERd	1	7	B	0:erd	1

### Notes

An overflow occurs if the original contents of ERd were H'80000000.

## 2.2.45 NOP

**NOP (No OPeration)**

**No Operation**

---

### Operation

PC + 2 → PC

### Condition Code

I	UI	H	U	N	Z	V	C
—	—	—	—	—	—	—	—

---

### Assembly-Language Format

NOP

- H: Previous value remains unchanged.  
N: Previous value remains unchanged.  
Z: Previous value remains unchanged.  
V: Previous value remains unchanged.  
C: Previous value remains unchanged.

---

### Operand Size

—

---

### Description

This instruction only increments the program counter, causing the next instruction to be executed. The internal state of the CPU does not change.

---

### Operand Format and Number of States Required for Execution

Addressing Mode	Mnemonic	Operands	Instruction Format				No. of States	
			1st byte	2nd byte	3rd byte	4th byte		
—	NOP		0	0	0	0		1

---

### Notes

## 2.2.46 (1) NOT (B)

NOT (NOT = logical complement)

Logical Complement

### Operation

$\neg$  Rd  $\rightarrow$  Rd

### Condition Code

I	UI	H	U	N	Z	V	C
—	—	—	—	↕	↕	0	—

### Assembly-Language Format

NOT .B Rd

- H: Previous value remains unchanged.  
 N: Set to 1 if the result is negative; otherwise cleared to 0.  
 Z: Set to 1 if the result is zero; otherwise cleared to 0.  
 V: Always cleared to 0.  
 C: Previous value remains unchanged.

### Operand Size

Byte

### Description

This instruction takes the one's complement of the contents of an 8-bit register Rd (destination operand) and stores the result in the 8-bit register Rd.

### Available Registers

Rd: R0L to R7L, R0H to R7H

### Operand Format and Number of States Required for Execution

Addressing Mode	Mnemonic	Operands	Instruction Format				No. of States
			1st byte	2nd byte	3rd byte	4th byte	
Register direct	NOT.B	Rd	1   7	0   rd			1

### Notes

## 2.2.46 (2) NOT (W)

NOT (NOT = logical complement)

Logical Complement

---

### Operation

$\neg R_d \rightarrow R_d$

### Condition Code

I	UI	H	U	N	Z	V	C
—	—	—	—	↕	↕	0	—

---

### Assembly-Language Format

NOT.W Rd

- H: Previous value remains unchanged.  
N: Set to 1 if the result is negative; otherwise cleared to 0.  
Z: Set to 1 if the result is zero; otherwise cleared to 0.  
V: Always cleared to 0.  
C: Previous value remains unchanged.

---

### Operand Size

Word

---

### Description

This instruction takes the one's complement of the contents of a 16-bit register Rd (destination operand) and stores the result in the 16-bit register Rd.

---

### Available Registers

Rd: R0 to R7, E0 to E7

---

### Operand Format and Number of States Required for Execution

Addressing Mode	Mnemonic	Operands	Instruction Format				No. of States	
			1st byte	2nd byte	3rd byte	4th byte		
Register direct	NOT.W	Rd	1	7	1	rd		1

---

### Notes

## 2.2.46 (3) NOT (L)

NOT (NOT = logical complement)

Logical Complement

### Operation

$\neg ERd \rightarrow ERd$

### Condition Code

I	UI	H	U	N	Z	V	C
—	—	—	—	↕	↕	0	—

### Assembly-Language Format

NOT.L ERd

- H: Previous value remains unchanged.  
 N: Set to 1 if the result is negative; otherwise cleared to 0.  
 Z: Set to 1 if the result is zero; otherwise cleared to 0.  
 V: Always cleared to 0.  
 C: Previous value remains unchanged.

### Operand Size

Longword

### Description

This instruction takes the one's complement of the contents of a 32-bit register ERd (destination operand) and stores the result in the 32-bit register ERd.

### Available Registers

ERd: ER0 to ER7

### Operand Format and Number of States Required for Execution

Addressing Mode	Mnemonic	Operands	Instruction Format				No. of States
			1st byte	2nd byte	3rd byte	4th byte	
Register direct	NOT.L	ERd	1	7	3	0:erd	1

### Notes

## 2.2.47 (1) OR (B)

### OR (inclusive OR logical)

### Logical OR

#### Operation

Rd  $\vee$  (EAs)  $\rightarrow$  Rd

#### Condition Code

I	UI	H	U	N	Z	V	C
—	—	—	—	↑	↑	0	—

#### Assembly-Language Format

OR.B <EAs>, Rd

- H: Previous value remains unchanged.  
N: Set to 1 if the result is negative; otherwise cleared to 0.  
Z: Set to 1 if the result is zero; otherwise cleared to 0.  
V: Always cleared to 0.  
C: Previous value remains unchanged.

#### Operand Size

Byte

#### Description

This instruction ORs the source operand with the contents of an 8-bit register Rd (destination operand) and stores the result in the 8-bit register Rd.

#### Available Registers

Rd: R0L to R7L, R0H to R7H

Rs: R0L to R7L, R0H to R7H

#### Operand Format and Number of States Required for Execution

Addressing Mode	Mnemonic	Operands	Instruction Format				No. of States
			1st byte	2nd byte	3rd byte	4th byte	
Immediate	OR.B	#xx:8, Rd	C	rd	IMM		1
Register direct	OR.B	Rs, Rd	1	4	rs	rd	1

#### Notes



## 2.2.47 (2) OR (W)

### OR (inclusive OR logical)

### Logical OR

#### Operation

Rd ∨ (EAs) → Rd

#### Condition Code

I	UI	H	U	N	Z	V	C
—	—	—	—	↕	↕	0	—

#### Assembly-Language Format

OR.W <EAs>, Rd

H: Previous value remains unchanged.

N: Set to 1 if the result is negative; otherwise cleared to 0.

Z: Set to 1 if the result is zero; otherwise cleared to 0.

V: Always cleared to 0.

C: Previous value remains unchanged.

#### Operand Size

Word

#### Description

This instruction ORs the source operand with the contents of a 16-bit register Rd (destination operand) and stores the result in the 16-bit register Rd.

#### Available Registers

Rd: R0 to R7, E0 to E7

Rs: R0 to R7, E0 to E7

#### Operand Format and Number of States Required for Execution

Addressing Mode	Mnemonic	Operands	Instruction Format				No. of States	
			1st byte	2nd byte	3rd byte	4th byte		
Immediate	OR.W	#xx:16, Rd	7	9	4	rd	IMM	2
Register direct	OR.W	Rs, Rd	6	4	rs	rd		1

#### Notes

## 2.2.47 (3) OR (L)

**OR (inclusive OR logical)**

**Logical OR**

### Operation

ERd ∨ (EAs) → ERd

### Condition Code

I	UI	H	U	N	Z	V	C
—	—	—	—	↑↓	↑↓	0	—

### Assembly-Language Format

OR.L <EAs>, ERd

- H: Previous value remains unchanged.
- N: Set to 1 if the result is negative; otherwise cleared to 0.
- Z: Set to 1 if the result is zero; otherwise cleared to 0.
- V: Always cleared to 0.
- C: Previous value remains unchanged.

### Operand Size

Longword

### Description

This instruction ORs the source operand with the contents of a 32-bit register ERd (destination operand) and stores the result in the 32-bit register ERd.

### Available Registers

ERd: ER0 to ER7

ERs: ER0 to ER7

### Operand Format and Number of States Required for Execution

Addressing Mode	Mnemonic	Operands	Instruction Format						No. of States	
			1st byte	2nd byte	3rd byte	4th byte	5th byte	6th byte		
Immediate	OR.L	#xx:32, ERd	7	A	4	0:erd	IMM			3
Register direct	OR.L	ERs, ERd	0	1	F	0	6	4	0:ers:0:erd	2

### Notes

## 2.2.48 (1) ORC

ORC (inclusive OR Control register)

Logical OR with CCR

### Operation

CCR  $\vee$  #IMM  $\rightarrow$  CCR

### Condition Code

I	UI	H	U	N	Z	V	C
↕	↕	↕	↕	↕	↕	↕	↕

### Assembly-Language Format

ORC #xx:8, CCR

### Operand Size

Byte

- I: Stores the corresponding bit of the result.
- UI: Stores the corresponding bit of the result.
- H: Stores the corresponding bit of the result.
- U: Stores the corresponding bit of the result.
- N: Stores the corresponding bit of the result.
- Z: Stores the corresponding bit of the result.
- V: Stores the corresponding bit of the result.
- C: Stores the corresponding bit of the result.

### Description

This instruction ORs the contents of the condition-code register (CCR) with immediate data and stores the result in the condition-code register. No interrupt requests, including NMI, are accepted immediately after execution of this instruction.

### Operand Format and Number of States Required for Execution

Addressing Mode	Mnemonic	Operands	Instruction Format				No. of States
			1st byte	2nd byte	3rd byte	4th byte	
Immediate	ORC	#xx:8, CCR	0	4	IMM		1

### Notes

## 2.2.48 (2) ORC

ORC (inclusive OR Control register)

Logical OR with EXR

---

### Operation

EXR  $\vee$  #IMM  $\rightarrow$  EXR

### Condition Code

I	UI	H	U	N	Z	V	C
—	—	—	—	—	—	—	—

---

### Assembly-Language Format

ORC #xx:8, EXR

- H: Stores the corresponding bit of the result.  
N: Stores the corresponding bit of the result.  
Z: Stores the corresponding bit of the result.  
V: Stores the corresponding bit of the result.  
C: Stores the corresponding bit of the result.

---

### Operand Size

Byte

---

### Description

This instruction ORs the contents of the extended control register (EXR) with immediate data and stores the result in the extended control register. No interrupt requests, including NMI, are accepted for three states after execution of this instruction.

---

### Operand Format and Number of States Required for Execution

Addressing Mode	Mnemonic	Operands	Instruction Format				No. of States			
			1st byte		2nd byte			3rd byte		4th byte
Immediate	ORC	#xx:8, EXR	0	1	4	1	0	4	IMM	2

---

### Notes

## 2.2.49 (1) POP (W)

### POP (POP data)

### Pop Data from Stack

#### Operation

@SP+ → Rn

#### Condition Code

I	UI	H	U	N	Z	V	C
—	—	—	—	↕	↕	0	—

#### Assembly-Language Format

POP.W Rn

- H: Previous value remains unchanged.  
N: Set to 1 if the transferred data is negative; otherwise cleared to 0.  
Z: Set to 1 if the transferred data is zero; otherwise cleared to 0.  
V: Always cleared to 0.  
C: Previous value remains unchanged.

#### Operand Size

Word

#### Description

This instruction restores data from the stack to a 16-bit general register Rn, tests the restored data, and sets condition-code flags according to the result.

#### Available Registers

Rn: R0 to R7, E0 to E7

#### Operand Format and Number of States Required for Execution

Addressing Mode	Mnemonic	Operands	Instruction Format				No. of States
			1st byte	2nd byte	3rd byte	4th byte	
—	POP.W	Rn	6 D	7 m			3

#### Notes

POP.W Rn is identical to MOV.W @SP+, Rn.

## 2.2.49 (2) POP (L)

### POP (POP data)

### Pop Data from Stack

#### Operation

@SP+ → ERn

#### Condition Code

I	UI	H	U	N	Z	V	C
—	—	—	—	↑	↓	0	—

#### Assembly-Language Format

POP.L ERn

- H: Previous value remains unchanged.  
N: Set to 1 if the transferred data is negative; otherwise cleared to 0.  
Z: Set to 1 if the transferred data is zero; otherwise cleared to 0.  
V: Always cleared to 0.  
C: Previous value remains unchanged.

#### Operand Size

Longword

#### Description

This instruction restores data from the stack to a 32-bit general register ERn, tests the restored data, and sets condition-code flags according to the result.

#### Available Registers

ERn: ER0 to ER7

#### Operand Format and Number of States Required for Execution

Addressing Mode	Mnemonic	Operands	Instruction Format								No. of States
			1st byte		2nd byte		3rd byte		4th byte		
—	POP.L	ERn	0	1	0	0	6	D	7	0:ern	5

#### Notes

POP.L ERn is identical to MOV.L @SP+, ERn.

## 2.2.50 (1) PUSH (W)

### PUSH (PUSH data)

### Push Data on Stack

#### Operation

Rn → @-SP

#### Condition Code

I	UI	H	U	N	Z	V	C
—	—	—	—	↕	↕	0	—

#### Assembly-Language Format

PUSH.W Rn

- H: Previous value remains unchanged.  
N: Set to 1 if the transferred data is negative; otherwise cleared to 0.  
Z: Set to 1 if the transferred data is zero; otherwise cleared to 0.  
V: Always cleared to 0.  
C: Previous value remains unchanged.

#### Operand Size

Word

#### Description

This instruction saves data from a 16-bit register Rn onto the stack, tests the saved data, and sets condition-code flags according to the result.

#### Available Registers

Rn: R0 to R7, E0 to E7

#### Operand Format and Number of States Required for Execution

Addressing Mode	Mnemonic	Operands	Instruction Format				No. of States
			1st byte	2nd byte	3rd byte	4th byte	
—	PUSH.W	Rn	6 D	F rn			3

#### Notes

1. PUSH.W Rn is identical to MOV.W Rn, @-SP.
2. When PUSH.W R7 or PUSH.W E7 is executed, the value saved on the stack is the R7 or E7 value after effective address calculation (after ER7 is decremented by 2).

## 2.2.50 (2) PUSH (L)

### PUSH (PUSH data)

### Push Data on Stack

#### Operation

ERn → @-SP

#### Condition Code

I	UI	H	U	N	Z	V	C
—	—	—	—	↑	↓	0	—

#### Assembly-Language Format

PUSH.L ERn

- H: Previous value remains unchanged.  
 N: Set to 1 if the transferred data is negative; otherwise cleared to 0.  
 Z: Set to 1 if the transferred data is zero; otherwise cleared to 0.  
 V: Always cleared to 0.  
 C: Previous value remains unchanged.

#### Operand Size

Longword

#### Description

This instruction pushes data from a 32-bit register ERn onto the stack, tests the saved data, and sets condition-code flags according to the result.

#### Available Registers

ERn: ER0 to ER7

#### Operand Format and Number of States Required for Execution

Addressing Mode	Mnemonic	Operands	Instruction Format								No. of States
			1st byte		2nd byte		3rd byte		4th byte		
—	PUSH.L	ERn	0	1	0	0	6	D	F	0:ern	5

#### Notes

1. PUSH.L ERn is identical to MOV.L ERn, @-SP.
2. When PUSH.L ER7 is executed, the value saved on the stack is the ER7 value after effective address calculation (after ER7 is decremented by 4).



## 2.2.51 (1) ROTL (B)

### ROTL (ROTate Left)

Rotate

#### Operation

Rd (left rotation) → Rd

#### Condition Code

I	UI	H	U	N	Z	V	C
—	—	—	—	↕	↕	0	↕

#### Assembly-Language Format

ROTL.B Rd

H: Previous value remains unchanged.

N: Set to 1 if the result is negative; otherwise cleared to 0.

Z: Set to 1 if the result is zero; otherwise cleared to 0.

V: Always cleared to 0.

C: Receives the previous value in bit 7.

#### Operand Size

Byte

#### Description

This instruction rotates the bits in an 8-bit register Rd (destination operand) one bit to the left. The most significant bit (bit 7) is rotated to the least significant bit (bit 0), and also copied to the carry flag.

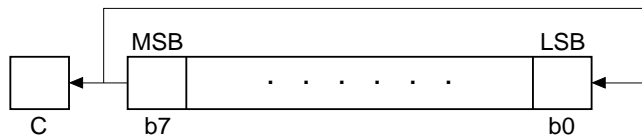

#### Available Registers

Rd: R0L to R7L, R0H to R7H

#### Operand Format and Number of States Required for Execution

Addressing Mode	Mnemonic	Operands	Instruction Format				No. of States
			1st byte	2nd byte	3rd byte	4th byte	
Register direct	ROTL.B	Rd	1	2	8	rd	1

#### Notes

## 2.2.51 (2) ROTL (B)

### ROTL (ROTate Left)

Rotate

#### Operation

Rd (left rotation) → Rd

#### Condition Code

I	UI	H	U	N	Z	V	C
—	—	—	—	↑	↑	0	↓

#### Assembly-Language Format

ROTL.B #2, Rd

#### Operand Size

Byte

- H: Previous value remains unchanged.
- N: Set to 1 if the result is negative; otherwise cleared to 0.
- Z: Set to 1 if the result is zero; otherwise cleared to 0.
- V: Always cleared to 0.
- C: Receives the previous value in bit 6.

#### Description

This instruction rotates the bits in an 8-bit register Rd (destination operand) two bits to the left. The most significant two bits (bits 7 and 6) are rotated to the least significant two bits (bits 1 and 0), and bit 6 is also copied to the carry flag.

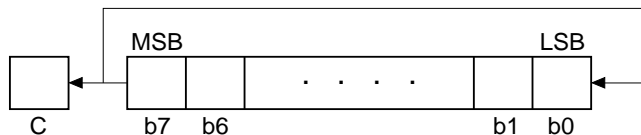

#### Available Registers

Rd: R0L to R7L, R0H to R7H

#### Operand Format and Number of States Required for Execution

Addressing Mode	Mnemonic	Operands	Instruction Format				No. of States
			1st byte	2nd byte	3rd byte	4th byte	
Register direct	ROTL.B	#2, Rd	1   2	C   rd			1

#### Notes

## 2.2.51 (3) ROTL (W)

### ROTL (ROTate Left)

Rotate

#### Operation

Rd (left rotation) → Rd

#### Condition Code

I	UI	H	U	N	Z	V	C
—	—	—	—	↕	↕	0	↕

#### Assembly-Language Format

ROTL.W Rd

- H: Previous value remains unchanged.  
 N: Set to 1 if the result is negative; otherwise cleared to 0.  
 Z: Set to 1 if the result is zero; otherwise cleared to 0.  
 V: Always cleared to 0.  
 C: Receives the previous value in bit 15.

#### Operand Size

Word

#### Description

This instruction rotates the bits in a 16-bit register Rd (destination operand) one bit to the left. The most significant bit (bit 15) is rotated to the least significant bit (bit 0), and also copied to the carry flag.

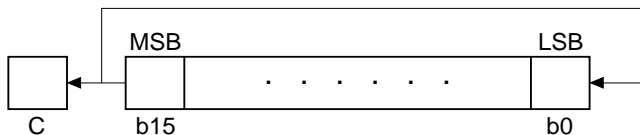

#### Available Registers

Rd: R0 to R7, E0 to E7

#### Operand Format and Number of States Required for Execution

Addressing Mode	Mnemonic	Operands	Instruction Format				No. of States
			1st byte	2nd byte	3rd byte	4th byte	
Register direct	ROTL.W	Rd	1	2	9	rd	1

#### Notes

## 2.2.51 (4) ROTL (W)

### ROTL (ROTate Left)

Rotate

#### Operation

Rd (left rotation) → Rd

#### Condition Code

I	UI	H	U	N	Z	V	C
—	—	—	—	↕	↕	0	↕

#### Assembly-Language Format

ROTL.W #2, Rd

#### Operand Size

Word

- H: Previous value remains unchanged.
- N: Set to 1 if the result is negative; otherwise cleared to 0.
- Z: Set to 1 if the result is zero; otherwise cleared to 0.
- V: Always cleared to 0.
- C: Receives the previous value in bit 14.

#### Description

This instruction rotates the bits in a 16-bit register Rd (destination operand) two bits to the left. The most significant two bits (bits 15 and 14) are rotated to the least significant two bits (bits 1 and 0), and bit 14 is also copied to the carry flag.



#### Available Registers

Rd: R0 to R7, E0 to E7

#### Operand Format and Number of States Required for Execution

Addressing Mode	Mnemonic	Operands	Instruction Format				No. of States
			1st byte	2nd byte	3rd byte	4th byte	
Register direct	ROTL.W	#2, Rd	1	2	D	rd	1

#### Notes

## 2.2.51 (5) ROTL (L)

### ROTL (ROTate Left)

Rotate

#### Operation

ERd (left rotation) → ERd

#### Condition Code

I	UI	H	U	N	Z	V	C
—	—	—	—	↕	↕	0	↕

#### Assembly-Language Format

ROTL.L ERd

H: Previous value remains unchanged.

N: Set to 1 if the result is negative; otherwise cleared to 0.

Z: Set to 1 if the result is zero; otherwise cleared to 0.

V: Always cleared to 0.

C: Receives the previous value in bit 31.

#### Operand Size

Longword

#### Description

This instruction rotates the bits in a 32-bit register ERd (destination operand) one bit to the left. The most significant bit (bit 31) is rotated to the least significant bit (bit 0), and also copied to the carry flag.

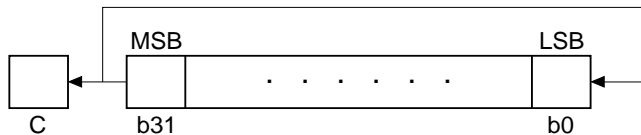

#### Available Registers

ERd: ER0 to ER7

#### Operand Format and Number of States Required for Execution

Addressing Mode	Mnemonic	Operands	Instruction Format				No. of States
			1st byte	2nd byte	3rd byte	4th byte	
Register direct	ROTL.L	ERd	1	2	B 0:erd		1

#### Notes

## 2.2.51 (6) ROTL (L)

### ROTL (ROTate Left)

Rotate

#### Operation

ERd (left rotation) → ERd

#### Condition Code

I	UI	H	U	N	Z	V	C
—	—	—	—	↕	↕	0	↕

#### Assembly-Language Format

ROTL.L #2, ERd

#### Operand Size

Longword

- H: Previous value remains unchanged.
- N: Set to 1 if the result is negative; otherwise cleared to 0.
- Z: Set to 1 if the result is zero; otherwise cleared to 0.
- V: Always cleared to 0.
- C: Receives the previous value in bit 30.

#### Description

This instruction rotates the bits in a 32-bit register ERd (destination operand) two bits to the left. The most significant two bits (bits 31 and 30) are rotated to the least significant two bits (bits 1 and 0), and bit 30 is also copied to the carry flag.

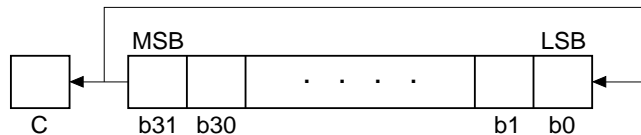

#### Available Registers

ERd: ER0 to ER7

#### Operand Format and Number of States Required for Execution

Addressing Mode	Mnemonic	Operands	Instruction Format				No. of States
			1st byte	2nd byte	3rd byte	4th byte	
Register direct	ROTL.L	#2, ERd	1	2	F 0	erd	1

#### Notes

## 2.2.52 (1) ROTR (B)

### ROTR (ROTate Right)

Rotate

#### Operation

Rd (right rotation) → Rd

#### Condition Code

I	UI	H	U	N	Z	V	C
—	—	—	—	↕	↕	0	↕

#### Assembly-Language Format

ROTR.B Rd

- H: Previous value remains unchanged.  
 N: Set to 1 if the result is negative; otherwise cleared to 0.  
 Z: Set to 1 if the result is zero; otherwise cleared to 0.  
 V: Always cleared to 0.  
 C: Receives the previous value in bit 0.

#### Operand Size

Byte

#### Description

This instruction rotates the bits in an 8-bit register Rd (destination operand) one bit to the right. The least significant bit (bit 0) is rotated to the most significant bit (bit 7), and also copied to the carry flag.

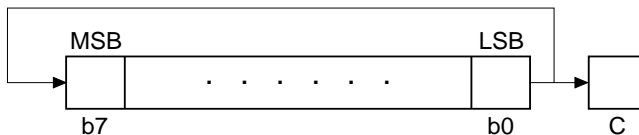

#### Available Registers

Rd: R0L to R7L, R0H to R7H

#### Operand Format and Number of States Required for Execution

Addressing Mode	Mnemonic	Operands	Instruction Format				No. of States
			1st byte	2nd byte	3rd byte	4th byte	
Register direct	ROTR.B	Rd	1	3	8	rd	1

#### Notes

## 2.2.52 (2) ROTR (B)

### ROTR (ROTate Right)

Rotate

#### Operation

Rd (right rotation) → Rd

#### Condition Code

I	UI	H	U	N	Z	V	C
—	—	—	—	↑	↑	0	↑

#### Assembly-Language Format

ROTR.B #2, Rd

#### Operand Size

Byte

- H: Previous value remains unchanged.
- N: Set to 1 if the result is negative; otherwise cleared to 0.
- Z: Set to 1 if the result is zero; otherwise cleared to 0.
- V: Always cleared to 0.
- C: Receives the previous value in bit 1.

#### Description

This instruction rotates the bits in an 8-bit register Rd (destination operand) two bits to the right. The least significant two bits (bits 1 and 0) are rotated to the most significant two bits (bits 7 and 6), and bit 1 is also copied to the carry flag.

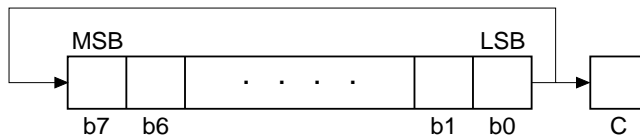

#### Available Registers

Rd: R0L to R7L, R0H to R7H

#### Operand Format and Number of States Required for Execution

Addressing Mode	Mnemonic	Operands	Instruction Format				No. of States
			1st byte	2nd byte	3rd byte	4th byte	
Register direct	ROTR.B	#2, Rd	1   3	C   rd			1

#### Notes



## 2.2.52 (3) ROTR (W)

### ROTR (ROTate Right)

Rotate

#### Operation

Rd (right rotation) → Rd

#### Condition Code

I	UI	H	U	N	Z	V	C
—	—	—	—	↕	↕	0	↕

#### Assembly-Language Format

ROTR.W Rd

- H: Previous value remains unchanged.  
 N: Set to 1 if the result is negative; otherwise cleared to 0.  
 Z: Set to 1 if the result is zero; otherwise cleared to 0.  
 V: Always cleared to 0.  
 C: Receives the previous value in bit 0.

#### Operand Size

Word

#### Description

This instruction rotates the bits in a 16-bit register Rd (destination operand) one bit to the right. The least significant bit (bit 0) is rotated to the most significant bit (bit 15), and also copied to the carry flag.

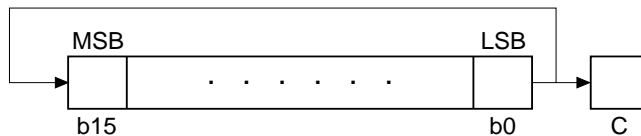

#### Available Registers

Rd: R0 to R7, E0 to E7

#### Operand Format and Number of States Required for Execution

Addressing Mode	Mnemonic	Operands	Instruction Format				No. of States
			1st byte	2nd byte	3rd byte	4th byte	
Register direct	ROTR.W	Rd	1	3	9	rd	1

#### Notes

## 2.2.52 (4) ROTR (W)

### ROTR (ROTate Right)

Rotate

#### Operation

Rd (right rotation) → Rd

#### Condition Code

I	UI	H	U	N	Z	V	C
—	—	—	—	↕	↕	0	↕

#### Assembly-Language Format

ROTR.W #2, Rd

#### Operand Size

Word

- H: Previous value remains unchanged.
- N: Set to 1 if the result is negative; otherwise cleared to 0.
- Z: Set to 1 if the result is zero; otherwise cleared to 0.
- V: Always cleared to 0.
- C: Receives the previous value in bit 1.

#### Description

This instruction rotates the bits in a 16-bit register Rd (destination operand) two bits to the right. The least significant two bits (bits 1 and 0) are rotated to the most significant two bits (bits 15 and 14), and bit 1 is also copied to the carry flag.

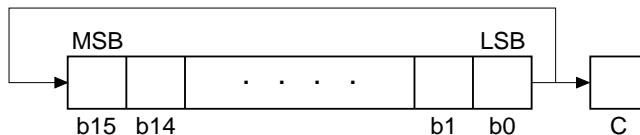

#### Available Registers

Rd: R0 to R7, E0 to E7

#### Operand Format and Number of States Required for Execution

Addressing Mode	Mnemonic	Operands	Instruction Format				No. of States
			1st byte	2nd byte	3rd byte	4th byte	
Register direct	ROTR.W	#2, Rd	1   3	D   rd			1

#### Notes

## 2.2.52 (5) ROTR (L)

### ROTR (ROTate Right)

Rotate

#### Operation

ERd (right rotation) → ERd

#### Condition Code

I	UI	H	U	N	Z	V	C
—	—	—	—	↕	↕	0	↕

#### Assembly-Language Format

ROTR.L ERd

H: Previous value remains unchanged.

N: Set to 1 if the result is negative; otherwise cleared to 0.

Z: Set to 1 if the result is zero; otherwise cleared to 0.

V: Always cleared to 0.

C: Receives the previous value in bit 0.

#### Operand Size

Longword

#### Description

This instruction rotates the bits in a 32-bit register ERd (destination operand) one bit to the right. The least significant bit (bit 0) is rotated to the most significant bit (bit 31), and also copied to the carry flag.

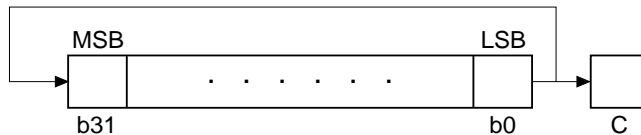

#### Available Registers

ERd: ER0 to ER7

#### Operand Format and Number of States Required for Execution

Addressing Mode	Mnemonic	Operands	Instruction Format				No. of States
			1st byte	2nd byte	3rd byte	4th byte	
Register direct	ROTR.L	ERd	1	3	B 0:erd		1

#### Notes

## 2.2.52 (6) ROTR (L)

### ROTR (ROTate Right)

Rotate

#### Operation

ERd (right rotation) → ERd

#### Condition Code

I	UI	H	U	N	Z	V	C
—	—	—	—	↕	↕	0	↕

#### Assembly-Language Format

ROTR.L #2, ERd

#### Operand Size

Longword

- H: Previous value remains unchanged.
- N: Set to 1 if the result is negative; otherwise cleared to 0.
- Z: Set to 1 if the result is zero; otherwise cleared to 0.
- V: Always cleared to 0.
- C: Receives the previous value in bit 1.

#### Description

This instruction rotates the bits in a 32-bit register ERd (destination operand) two bits to the right. The least significant two bits (bits 1 and 0) are rotated to the most significant two bits (bits 31 and 30), and bit 1 is also copied to the carry flag.

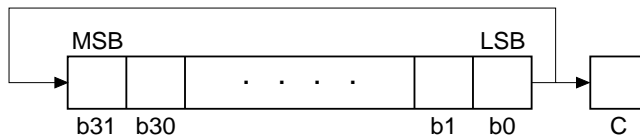

#### Available Registers

ERd: ER0 to ER7

#### Operand Format and Number of States Required for Execution

Addressing Mode	Mnemonic	Operands	Instruction Format				No. of States
			1st byte	2nd byte	3rd byte	4th byte	
Register direct	ROTR.L	#2, ERd	1	3	F	0:erd	1

#### Notes

## 2.2.53 (1) ROTXL (B)

### ROTXL (ROtate with eXtend carry Left)

Rotate through Carry

#### Operation

Rd (left rotation through carry flag) → Rd

#### Condition Code

I	UI	H	U	N	Z	V	C
—	—	—	—	↕	↕	0	↕

#### Assembly-Language Format

ROTXL.B Rd

- H: Previous value remains unchanged.
- N: Set to 1 if the result is negative; otherwise cleared to 0.
- Z: Set to 1 if the result is zero; otherwise cleared to 0.
- V: Always cleared to 0.
- C: Receives the previous value in bit 7.

#### Operand Size

Byte

#### Description

This instruction rotates the bits in an 8-bit register Rd (destination operand) one bit to the left through the carry flag. The carry flag is rotated into the least significant bit (bit 0). The most significant bit (bit 7) rotates into the carry flag.

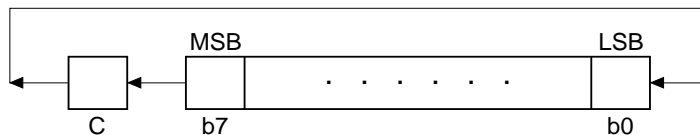

#### Available Registers

Rd: R0L to R7L, R0H to R7H

#### Operand Format and Number of States Required for Execution

Addressing Mode	Mnemonic	Operands	Instruction Format				No. of States
			1st byte	2nd byte	3rd byte	4th byte	
Register direct	ROTXL.B	Rd	1	2	0	rd	1

#### Notes

## 2.2.53 (2) ROTXL (B)

### ROTXL (ROtate with eXtend carry Left)

### Rotate through Carry

#### Operation

Rd (left rotation through carry flag) → Rd

#### Condition Code

I	UI	H	U	N	Z	V	C
—	—	—	—	↕	↕	0	↕

#### Assembly-Language Format

ROTXL.B #2, Rd

#### Operand Size

Byte

- H: Previous value remains unchanged.
- N: Set to 1 if the result is negative; otherwise cleared to 0.
- Z: Set to 1 if the result is zero; otherwise cleared to 0.
- V: Always cleared to 0.
- C: Receives the previous value in bit 6.

#### Description

This instruction rotates the bits in an 8-bit register Rd (destination operand) two bits to the left through the carry flag. The carry flag rotates into bit 1, bit 7 rotates into bit 0, and bit 6 rotates into the carry flag.

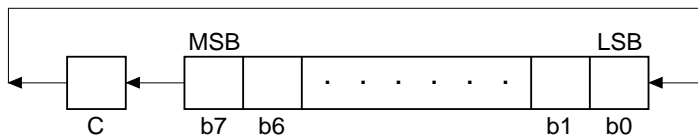

#### Available Registers

Rd: R0L to R7L, R0H to R7H

#### Operand Format and Number of States Required for Execution

Addressing Mode	Mnemonic	Operands	Instruction Format				No. of States
			1st byte	2nd byte	3rd byte	4th byte	
Register direct	ROTXL.B	#2, Rd	1	2	4	rd	1

#### Notes

## 2.2.53 (3) ROTXL (W)

### ROTXL (ROtate with eXtend carry Left)

Rotate through Carry

#### Operation

Rd (left rotation through carry flag) → Rd

#### Condition Code

I	UI	H	U	N	Z	V	C
—	—	—	—	↕	↕	0	↕

#### Assembly-Language Format

ROTXL.W Rd

- H: Previous value remains unchanged.
- N: Set to 1 if the result is negative; otherwise cleared to 0.
- Z: Set to 1 if the result is zero; otherwise cleared to 0.
- V: Always cleared to 0.
- C: Receives the previous value in bit 15.

#### Operand Size

Word

#### Description

This instruction rotates the bits in a 16-bit register Rd (destination operand) one bit to the left through the carry flag. The carry flag is rotated into the least significant bit (bit 0). The most significant bit (bit 15) rotates into the carry flag.

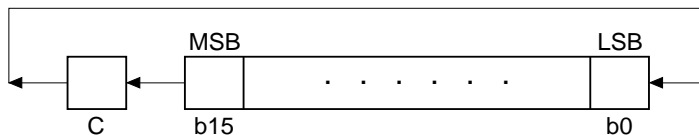

#### Available Registers

Rd: R0 to R7, E0 to E7

#### Operand Format and Number of States Required for Execution

Addressing Mode	Mnemonic	Operands	Instruction Format				No. of States
			1st byte	2nd byte	3rd byte	4th byte	
Register direct	ROTXL.W	Rd	1	2	1	rd	1

#### Notes

## 2.2.53 (4) ROTXL (W)

### ROTXL (ROtate with eXtend carry Left)

### Rotate through Carry

#### Operation

Rd (left rotation through carry flag) → Rd

#### Condition Code

I	UI	H	U	N	Z	V	C
—	—	—	—	↕	↕	0	↕

#### Assembly-Language Format

ROTXL.W #2, Rd

#### Operand Size

Word

- H: Previous value remains unchanged.
- N: Set to 1 if the result is negative; otherwise cleared to 0.
- Z: Set to 1 if the result is zero; otherwise cleared to 0.
- V: Always cleared to 0.
- C: Receives the previous value in bit 14.

#### Description

This instruction rotates the bits in a 16-bit register Rd (destination operand) two bits to the left through the carry flag. The carry flag rotates into bit 1, bit 15 rotates into bit 0, and bit 14 rotates into the carry flag.

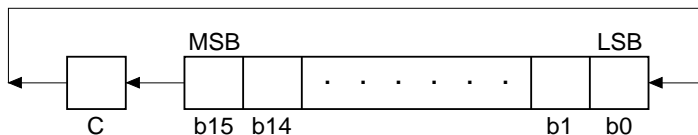

#### Available Registers

Rd: R0 to R7, E0 to E7

#### Operand Format and Number of States Required for Execution

Addressing Mode	Mnemonic	Operands	Instruction Format				No. of States
			1st byte	2nd byte	3rd byte	4th byte	
Register direct	ROTXL.W	#2, Rd	1	2	5	rd	1

#### Notes



## 2.2.53 (5) ROTXL (L)

### ROTXL (ROtate with eXtend carry Left)

Rotate through Carry

#### Operation

ERd (left rotation through carry flag) → ERd

#### Condition Code

I	UI	H	U	N	Z	V	C
—	—	—	—	↕	↕	0	↕

#### Assembly-Language Format

ROTXL.L ERd

- H: Previous value remains unchanged.
- N: Set to 1 if the result is negative; otherwise cleared to 0.
- Z: Set to 1 if the result is zero; otherwise cleared to 0.
- V: Always cleared to 0.
- C: Receives the previous value in bit 31.

#### Operand Size

Longword

#### Description

This instruction rotates the bits in a 32-bit register ERd (destination operand) one bit to the left through the carry flag. The carry flag is rotated into the least significant bit (bit 0). The most significant bit (bit 31) rotates into the carry flag.

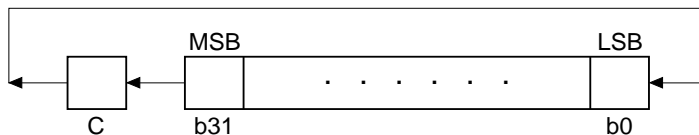

#### Available Registers

ERd: ER0 to ER7

#### Operand Format and Number of States Required for Execution

Addressing Mode	Mnemonic	Operands	Instruction Format				No. of States
			1st byte	2nd byte	3rd byte	4th byte	
Register direct	ROTXL.L	ERd	1	2	3	0:erd	1

#### Notes

## 2.2.53 (6) ROTXL (L)

### ROTXL (ROtate with eXtend carry Left)

### Rotate through Carry

#### Operation

ERd (left rotation through carry flag) → ERd

#### Condition Code

I	UI	H	U	N	Z	V	C
—	—	—	—	↕	↕	0	↕

#### Assembly-Language Format

ROTXL.L #2, ERd

#### Operand Size

Longword

- H: Previous value remains unchanged.
- N: Set to 1 if the result is negative; otherwise cleared to 0.
- Z: Set to 1 if the result is zero; otherwise cleared to 0.
- V: Always cleared to 0.
- C: Receives the previous value in bit 30.

#### Description

This instruction rotates the bits in a 32-bit register ERd (destination operand) two bits to the left through the carry flag. The carry flag rotates into bit 1, bit 31 rotates into bit 0, and bit 30 rotates into into the carry flag.

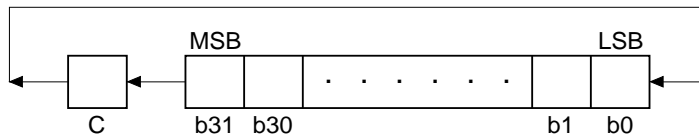

#### Available Registers

ERd: ER0 to ER7

#### Operand Format and Number of States Required for Execution

Addressing Mode	Mnemonic	Operands	Instruction Format				No. of States
			1st byte	2nd byte	3rd byte	4th byte	
Register direct	ROTXL.L	#2, ERd	1	2	7	0:erd	1

#### Notes

## 2.2.54 (1) ROTXR (B)

### ROTXR (ROtate with eXtend carry Right)

Rotate through Carry

#### Operation

Rd (right rotation through carry flag) → Rd

#### Condition Code

I	UI	H	U	N	Z	V	C
—	—	—	—	↕	↕	0	↕

#### Assembly-Language Format

ROTXR.B Rd

- H: Previous value remains unchanged.
- N: Set to 1 if the result is negative; otherwise cleared to 0.
- Z: Set to 1 if the result is zero; otherwise cleared to 0.
- V: Always cleared to 0.
- C: Receives the previous value in bit 0.

#### Operand Size

Byte

#### Description

This instruction rotates the bits in an 8-bit register Rd (destination operand) one bit to the right through the carry flag. The carry flag is rotated into the most significant bit (bit 7). The least significant bit (bit 0) rotates into the carry flag.

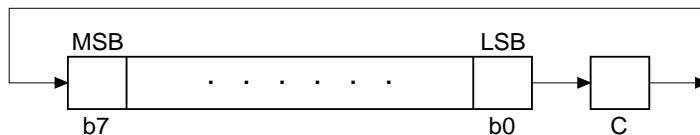

#### Available Registers

Rd: R0L to R7L, R0H to R7H

#### Operand Format and Number of States Required for Execution

Addressing Mode	Mnemonic	Operands	Instruction Format				No. of States
			1st byte	2nd byte	3rd byte	4th byte	
Register direct	ROTXR.B	Rd	1	3	0	rd	1

#### Notes

## 2.2.54 (2) ROTXR (B)

### ROTXR (ROtate with eXtend carry Right)

### Rotate through Carry

#### Operation

Rd (right rotation through carry flag) → Rd

#### Condition Code

I	UI	H	U	N	Z	V	C
—	—	—	—	↕	↕	0	↕

#### Assembly-Language Format

ROTXR.B #2, Rd

#### Operand Size

Byte

- H: Previous value remains unchanged.
- N: Set to 1 if the result is negative; otherwise cleared to 0.
- Z: Set to 1 if the result is zero; otherwise cleared to 0.
- V: Always cleared to 0.
- C: Receives the previous value in bit 1.

#### Description

This instruction rotates the bits in an 8-bit register Rd (destination operand) two bits to the right through the carry flag. The carry flag rotates into bit 6, bit 0 rotates into bit 7, and bit 1 rotates into the carry flag.

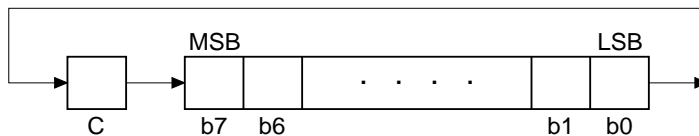

#### Available Registers

Rd: R0L to R7L, R0H to R7H

#### Operand Format and Number of States Required for Execution

Addressing Mode	Mnemonic	Operands	Instruction Format				No. of States
			1st byte	2nd byte	3rd byte	4th byte	
Register direct	ROTXR.B	#2, Rd	1   3	4   rd			1

#### Notes

## 2.2.54 (3) ROTXR (W)

### ROTXR (ROtate with eXtend carry Right)

Rotate through Carry

#### Operation

Rd (right rotation through carry flag) → Rd

#### Condition Code

I	UI	H	U	N	Z	V	C
—	—	—	—	↕	↕	0	↕

#### Assembly-Language Format

ROTXR.W Rd

- H: Previous value remains unchanged.
- N: Set to 1 if the result is negative; otherwise cleared to 0.
- Z: Set to 1 if the result is zero; otherwise cleared to 0.
- V: Always cleared to 0.
- C: Receives the previous value in bit 0.

#### Operand Size

Word

#### Description

This instruction rotates the bits in a 16-bit register Rd (destination operand) one bit to the right through the carry flag. The carry flag is rotated into the most significant bit (bit 15). The least significant bit (bit 0) rotates into the carry flag.

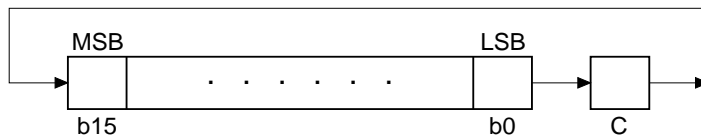

#### Available Registers

Rd: R0 to R7, E0 to E7

#### Operand Format and Number of States Required for Execution

Addressing Mode	Mnemonic	Operands	Instruction Format				No. of States
			1st byte	2nd byte	3rd byte	4th byte	
Register direct	ROTXR.W	Rd	1	3	1	rd	1

#### Notes

## 2.2.54 (4) ROTXR (W)

### ROTXR (ROtate with eXtend carry Right)

Rotate through Carry

#### Operation

Rd (right rotation through carry flag) → Rd

#### Condition Code

I	UI	H	U	N	Z	V	C
—	—	—	—	↕	↕	0	↕

#### Assembly-Language Format

ROTXR.W #2, Rd

#### Operand Size

Word

- H: Previous value remains unchanged.
- N: Set to 1 if the result is negative; otherwise cleared to 0.
- Z: Set to 1 if the result is zero; otherwise cleared to 0.
- V: Always cleared to 0.
- C: Receives the previous value in bit 1.

#### Description

This instruction rotates the bits in a 16-bit register Rd (destination operand) two bits to the right through the carry flag. The carry flag rotates into bit 14, bit 0 rotates into bit 15, and bit 1 rotates into the carry flag.

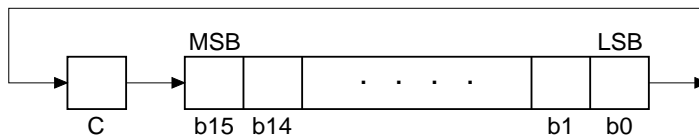

#### Available Registers

Rd: R0 to R7, E0 to E7

#### Operand Format and Number of States Required for Execution

Addressing Mode	Mnemonic	Operands	Instruction Format				No. of States
			1st byte	2nd byte	3rd byte	4th byte	
Register direct	ROTXR.W	#2, Rd	1   3	5   rd			1

#### Notes

## 2.2.54 (5) ROTXR (L)

### ROTXR (ROtate with eXtend carry Right)

Rotate through Carry

#### Operation

ERd (right rotation through carry flag) → ERd

#### Condition Code

I	UI	H	U	N	Z	V	C
—	—	—	—	↕	↕	0	↕

#### Assembly-Language Format

ROTXR.L ERd

H: Previous value remains unchanged.

N: Set to 1 if the result is negative; otherwise cleared to 0.

Z: Set to 1 if the result is zero; otherwise cleared to 0.

V: Always cleared to 0.

C: Receives the previous value in bit 0.

#### Operand Size

Longword

#### Description

This instruction rotates the bits in a 32-bit register ERd (destination operand) one bit to the right through the carry flag. The carry flag is rotated into the most significant bit (bit 31). The least significant bit (bit 0) rotates into the carry flag.

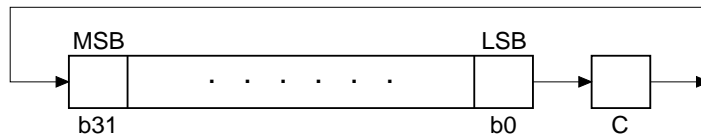

#### Available Registers

ERd: ER0 to ER7

#### Operand Format and Number of States Required for Execution

Addressing Mode	Mnemonic	Operands	Instruction Format				No. of States
			1st byte	2nd byte	3rd byte	4th byte	
Register direct	ROTXR.L	ERd	1	3	3	0:erd	1

#### Notes

## 2.2.54 (6) ROTXR (L)

### ROTXR (ROtate with eXtend carry Right)

Rotate through Carry

#### Operation

ERd (right rotation through carry flag) → ERd

#### Condition Code

I	UI	H	U	N	Z	V	C
—	—	—	—	↕	↕	0	↕

#### Assembly-Language Format

ROTXR.L #2, ERd

#### Operand Size

Longword

- H: Previous value remains unchanged.
- N: Set to 1 if the result is negative; otherwise cleared to 0.
- Z: Set to 1 if the result is zero; otherwise cleared to 0.
- V: Always cleared to 0.
- C: Receives the previous value in bit 1.

#### Description

This instruction rotates the bits in a 32-bit register ERd (destination operand) two bits to the right through the carry flag. The carry flag rotates into bit 30, bit 0 rotates into bit 31, and bit 1 rotates into the carry flag.

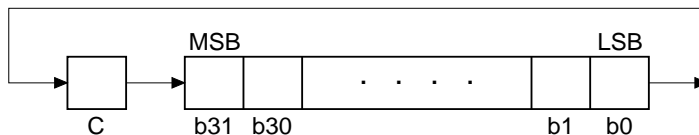

#### Available Registers

ERd: ER0 to ER7

#### Operand Format and Number of States Required for Execution

Addressing Mode	Mnemonic	Operands	Instruction Format				No. of States
			1st byte	2nd byte	3rd byte	4th byte	
Register direct	ROTXR.L	#2, ERd	1	3	7	0:erd	1

#### Notes



**RTE (ReTurn from Exception)****Return from Exception Handling****Operation**

- When EXR is invalid
  - @SP+ → CCR
  - @SP+ → PC
- When EXR is valid
  - @SP+ → EXR
  - @SP+ → CCR
  - @SP+ → PC

**Assembly-Language Format**

RTE

**Operand Size**

—

**Condition Code**

I	UI	H	U	N	Z	V	C
↕	↕	↕	↕	↕	↕	↕	↕

- I: Restored from the corresponding bit on the stack.
- UI: Restored from the corresponding bit on the stack.
- H: Restored from the corresponding bit on the stack.
- U: Restored from the corresponding bit on the stack.
- N: Restored from the corresponding bit on the stack.
- Z: Restored from the corresponding bit on the stack.
- V: Restored from the corresponding bit on the stack.
- C: Restored from the corresponding bit on the stack.

**Description**

This instruction returns from an exception-handling routine by restoring the EXR, condition-code register (CCR) and program counter (PC) from the stack. Program execution continues from the address restored to the program counter. The CCR and PC contents at the time of execution of this instruction are lost. If the extended control register (EXR) is valid, it is also restored (and the existing EXR contents are lost).

**Operand Format and Number of States Required for Execution**

Addressing Mode	Mnemonic	Operands	Instruction Format				No. of States
			1st byte	2nd byte	3rd byte	4th byte	
—	RTE		5	6	7	0	5*

Note: \* Six states when EXR is valid.

Notes

The stack structure differs between normal mode and advanced mode.

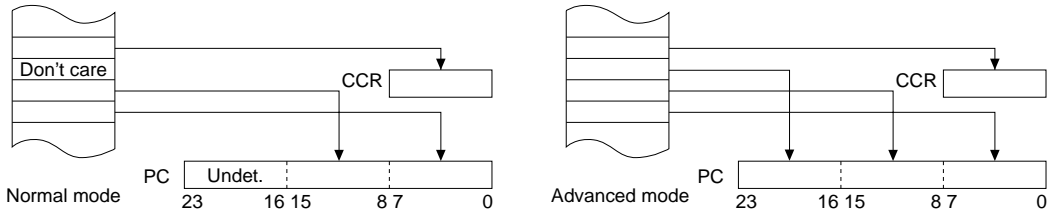

**Operation**

@SP+ → PC

**Condition Code**

I	UI	H	U	N	Z	V	C
—	—	—	—	—	—	—	—

**Assembly-Language Format**

RTS

- H: Previous value remains unchanged.
- N: Previous value remains unchanged.
- Z: Previous value remains unchanged.
- V: Previous value remains unchanged.
- C: Previous value remains unchanged.

**Operand Size**

—

**Description**

This instruction returns from a subroutine by restoring the program counter (PC) from the stack. Program execution continues from the address restored to the program counter. The PC contents at the time of execution of this instruction are lost.

**Operand Format and Number of States Required for Execution**

Addressing Mode	Mnemonic	Operands	Instruction Format				No. of States	
			1st byte	2nd byte	3rd byte	4th byte	Normal	Advanced
—	RTS		5	4	7	0	4	5

**Notes**

The stack structure and number of states required for execution differ between normal mode and advanced mode. In normal mode, only the lower 16 bits of the program counter are restored.

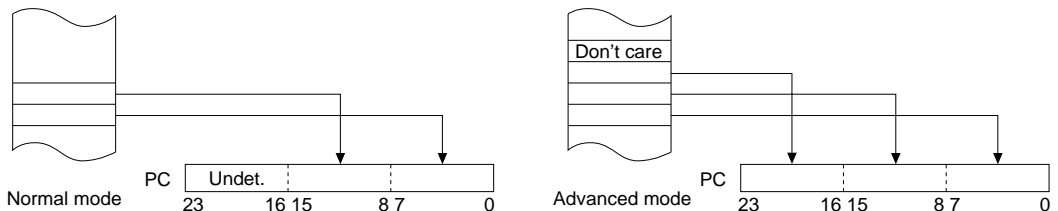

## 2.2.57 (1) SHAL (B)

### SHAL (SHift Arithmetic Left)

Shift Arithmetic

#### Operation

Rd (left arithmetic shift) → Rd

#### Condition Code

I	UI	H	U	N	Z	V	C
—	—	—	—	↕	↕	↕	↕

#### Assembly-Language Format

SHAL.B Rd

#### Operand Size

Byte

- H: Previous value remains unchanged.
- N: Set to 1 if the result is negative; otherwise cleared to 0.
- Z: Set to 1 if the result is zero; otherwise cleared to 0.
- V: Set to 1 if an overflow occurs; otherwise cleared to 0.
- C: Receives the previous value in bit 7.

#### Description

This instruction shifts the bits in an 8-bit register Rd (destination operand) one bit to the left. The most significant bit (bit 7) shifts into the carry flag. The least significant bit (bit 0) is cleared to 0.

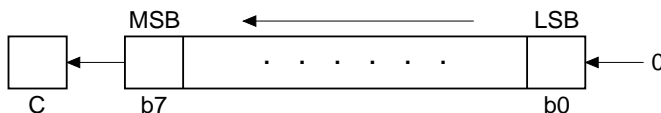

#### Available Registers

Rd: R0L to R7L, R0H to R7H

#### Operand Format and Number of States Required for Execution

Addressing Mode	Mnemonic	Operands	Instruction Format				No. of States
			1st byte	2nd byte	3rd byte	4th byte	
Register direct	SHAL.B	Rd	1 0	8 rd			1

#### Notes

The SHAL instruction differs from the SHLL instruction in its effect on the overflow flag.

## 2.2.57 (2) SHAL (B)

### SHAL (SHift Arithmetic Left)

Shift Arithmetic

#### Operation

Rd (left arithmetic shift) → Rd

#### Condition Code

I	UI	H	U	N	Z	V	C
—	—	—	—	↕	↕	↕	↕

#### Assembly-Language Format

SHAL.B #2, Rd

#### Operand Size

Byte

- H: Previous value remains unchanged.
- N: Set to 1 if the result is negative; otherwise cleared to 0.
- Z: Set to 1 if the result is zero; otherwise cleared to 0.
- V: Set to 1 if an overflow occurs; otherwise cleared to 0.
- C: Receives the previous value in bit 6.

#### Description

This instruction shifts the bits in an 8-bit register Rd (destination operand) two bits to the left. Bit 6 shifts into the carry flag. Bits 0 and 1 are cleared to 0.

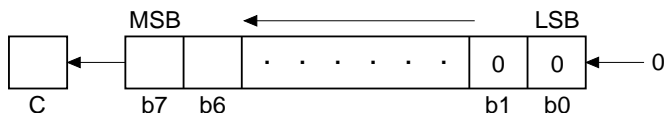

#### Available Registers

Rd: R0L to R7L, R0H to R7H

#### Operand Format and Number of States Required for Execution

Addressing Mode	Mnemonic	Operands	Instruction Format				No. of States
			1st byte	2nd byte	3rd byte	4th byte	
Register direct	SHAL.B	#2, Rd	1 0	C rd			1

#### Notes

The SHAL instruction differs from the SHLL instruction in its effect on the overflow flag.

## 2.2.57 (3) SHAL (W)

### SHAL (SHift Arithmetic Left)

### Shift Arithmetic

#### Operation

Rd (left arithmetic shift) → Rd

#### Condition Code

I	UI	H	U	N	Z	V	C
—	—	—	—	↕	↕	↕	↕

#### Assembly-Language Format

SHAL.W Rd

#### Operand Size

Word

- H: Previous value remains unchanged.
- N: Set to 1 if the result is negative; otherwise cleared to 0.
- Z: Set to 1 if the result is zero; otherwise cleared to 0.
- V: Set to 1 if an overflow occurs; otherwise cleared to 0.
- C: Receives the previous value in bit 15.

#### Description

This instruction shifts the bits in a 16-bit register Rd (destination operand) one bit to the left. The most significant bit (bit 15) shifts into the carry flag. The least significant bit (bit 0) is cleared to 0.

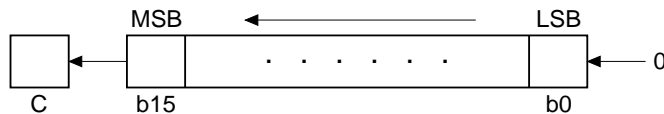

#### Available Registers

Rd: R0 to R7, E0 to E7

#### Operand Format and Number of States Required for Execution

Addressing Mode	Mnemonic	Operands	Instruction Format				No. of States
			1st byte	2nd byte	3rd byte	4th byte	
Register direct	SHAL.W	Rd	1 0	9 rd			1

#### Notes

The SHAL instruction differs from the SHLL instruction in its effect on the overflow flag.

## 2.2.57 (4) SHAL (W)

### SHAL (SHift Arithmetic Left)

### Shift Arithmetic

#### Operation

Rd (left arithmetic shift) → Rd

#### Condition Code

I	UI	H	U	N	Z	V	C
—	—	—	—	↕	↕	↕	↕

#### Assembly-Language Format

SHAL .w #2, Rd

H: Previous value remains unchanged.

N: Set to 1 if the result is negative; otherwise cleared to 0.

Z: Set to 1 if the result is zero; otherwise cleared to 0.

V: Set to 1 if an overflow occurs; otherwise cleared to 0.

C: Receives the previous value in bit 14.

#### Operand Size

Word

#### Description

This instruction shifts the bits in a 16-bit register Rd (destination operand) two bits to the left. Bit 14 shifts into the carry flag. Bits 0 and 1 are cleared to 0.

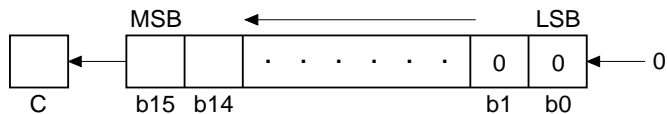

#### Available Registers

Rd: R0 to R7, E0 to E7

#### Operand Format and Number of States Required for Execution

Addressing Mode	Mnemonic	Operands	Instruction Format				No. of States
			1st byte	2nd byte	3rd byte	4th byte	
Register direct	SHAL.W	#2, Rd	1 0	D rd			1

#### Notes

The SHAL instruction differs from the SHLL instruction in its effect on the overflow flag.

## 2.2.57 (5) SHAL (L)

### SHAL (SHift Arithmetic Left)

Shift Arithmetic

#### Operation

ERd (left arithmetic shift) → ERd

#### Condition Code

I	UI	H	U	N	Z	V	C
—	—	—	—	↕	↕	↕	↕

#### Assembly-Language Format

SHAL.L ERd

#### Operand Size

Longword

- H: Previous value remains unchanged.
- N: Set to 1 if the result is negative; otherwise cleared to 0.
- Z: Set to 1 if the result is zero; otherwise cleared to 0.
- V: Set to 1 if an overflow occurs; otherwise cleared to 0.
- C: Receives the previous value in bit 31.

#### Description

This instruction shifts the bits in a 32-bit register ERd (destination operand) one bit to the left. The most significant bit (bit 31) shifts into the carry flag. The least significant bit (bit 0) is cleared to 0.

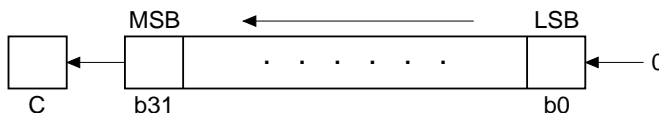

#### Available Registers

ERd: ER0 to ER7

#### Operand Format and Number of States Required for Execution

Addressing Mode	Mnemonic	Operands	Instruction Format				No. of States
			1st byte	2nd byte	3rd byte	4th byte	
Register direct	SHAL.L	ERd	1	0	B	0:erd	1

#### Notes

The SHAL instruction differs from the SHLL instruction in its effect on the overflow flag.



## 2.2.57 (6) SHAL (L)

### SHAL (SHift Arithmetic Left)

Shift Arithmetic

#### Operation

ERd (left arithmetic shift) → ERd

#### Condition Code

I	UI	H	U	N	Z	V	C
—	—	—	—	↕	↕	↕	↕

#### Assembly-Language Format

SHAL.L #2, ERd

#### Operand Size

Longword

- H: Previous value remains unchanged.
- N: Set to 1 if the result is negative; otherwise cleared to 0.
- Z: Set to 1 if the result is zero; otherwise cleared to 0.
- V: Set to 1 if an overflow occurs; otherwise cleared to 0.
- C: Receives the previous value in bit 30.

#### Description

This instruction shifts the bits in a 32-bit register ERd (destination operand) two bits to the left. Bit 30 shifts into the carry flag. Bits 0 and 1 are cleared to 0.

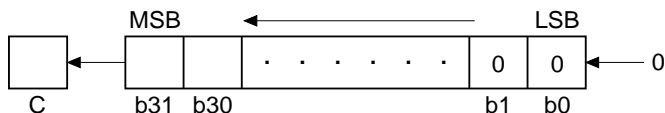

#### Available Registers

ERd: ER0 to ER7

#### Operand Format and Number of States Required for Execution

Addressing Mode	Mnemonic	Operands	Instruction Format				No. of States
			1st byte	2nd byte	3rd byte	4th byte	
Register direct	SHAL.L	#2, ERd	1 0	F 0	erd		1

#### Notes

The SHAL instruction differs from the SHLL instruction in its effect on the overflow flag.

## 2.2.58 (1) SHAR (B)

### SHAR (SHift Arithmetic Right)

### Shift Arithmetic

#### Operation

Rd (right arithmetic shift) → Rd

#### Condition Code

I	UI	H	U	N	Z	V	C
—	—	—	—	↑	↓	0	↓

#### Assembly-Language Format

SHAR.B Rd

#### Operand Size

Byte

- H: Previous value remains unchanged.
- N: Set to 1 if the result is negative; otherwise cleared to 0.
- Z: Set to 1 if the result is zero; otherwise cleared to 0.
- V: Always cleared to 0.
- C: Receives the previous value in bit 0.

#### Description

This instruction shifts the bits in an 8-bit register Rd (destination operand) one bit to the right. Bit 0 shifts into the carry flag. Bit 7 shifts into itself. Since bit 7 remains unaltered, the sign does not change.

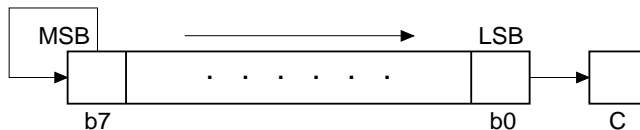

#### Available Registers

Rd: R0L to R7L, R0H to R7H

#### Operand Format and Number of States Required for Execution

Addressing Mode	Mnemonic	Operands	Instruction Format				No. of States
			1st byte	2nd byte	3rd byte	4th byte	
Register direct	SHAR.B	Rd	1	1	8	rd	1

#### Notes

## 2.2.58 (2) SHAR (B)

### SHAR (SHift Arithmetic Right)

### Shift Arithmetic

#### Operation

Rd (right arithmetic shift) → Rd

#### Condition Code

I	UI	H	U	N	Z	V	C
—	—	—	—	↕	↕	0	↕

#### Assembly-Language Format

SHAR.B #2, Rd

- H: Previous value remains unchanged.
- N: Set to 1 if the result is negative; otherwise cleared to 0.
- Z: Set to 1 if the result is zero; otherwise cleared to 0.
- V: Always cleared to 0.
- C: Receives the previous value in bit 1.

#### Operand Size

Byte

#### Description

This instruction shifts the bits in an 8-bit register Rd (destination operand) two bits to the right. Bit 1 shifts into the carry flag. Bits 7 and 6 receive the previous value of bit 7. Since bit 7 remains unaltered, the sign does not change.

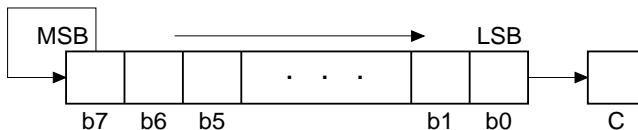

#### Available Registers

Rd: R0L to R7L, R0H to R7H

#### Operand Format and Number of States Required for Execution

Addressing Mode	Mnemonic	Operands	Instruction Format				No. of States
			1st byte	2nd byte	3rd byte	4th byte	
Register direct	SHAR.B	#2, Rd	1	1	C	rd	1

#### Notes

## 2.2.58 (3) SHAR (W)

### SHAR (SHift Arithmetic Right)

### Shift Arithmetic

#### Operation

Rd (right arithmetic shift) → Rd

#### Condition Code

I	UI	H	U	N	Z	V	C
—	—	—	—	↕	↕	0	↕

#### Assembly-Language Format

SHAR.W Rd

#### Operand Size

Word

- H: Previous value remains unchanged.
- N: Set to 1 if the result is negative; otherwise cleared to 0.
- Z: Set to 1 if the result is zero; otherwise cleared to 0.
- V: Always cleared to 0.
- C: Receives the previous value in bit 0.

#### Description

This instruction shifts the bits in a 16-bit register Rd (destination operand) one bit to the right. Bit 0 shifts into the carry flag. Bit 15 shifts into itself. Since bit 15 remains unaltered, the sign does not change.

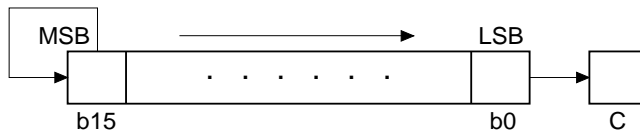

#### Available Registers

Rd: R0 to R7, E0 to E7

#### Operand Format and Number of States Required for Execution

Addressing Mode	Mnemonic	Operands	Instruction Format				No. of States
			1st byte	2nd byte	3rd byte	4th byte	
Register direct	SHAR.W	Rd	1	1	9	rd	1

#### Notes

## 2.2.58 (4) SHAR (W)

### SHAR (SHift Arithmetic Right)

### Shift Arithmetic

#### Operation

Rd (right arithmetic shift) → Rd

#### Condition Code

I	UI	H	U	N	Z	V	C
—	—	—	—	↕	↕	0	↕

#### Assembly-Language Format

SHAR.W #2, Rd

- H: Previous value remains unchanged.
- N: Set to 1 if the result is negative; otherwise cleared to 0.
- Z: Set to 1 if the result is zero; otherwise cleared to 0.
- V: Always cleared to 0.
- C: Receives the previous value in bit 1.

#### Operand Size

Word

#### Description

This instruction shifts the bits in a 16-bit register Rd (destination operand) two bits to the right. Bit 1 shifts into the carry flag. Bits 15 and 14 receive the previous value of bit 15. Since bit 15 remains unaltered, the sign does not change.

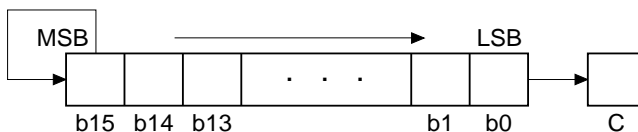

#### Available Registers

Rd: R0 to R7, E0 to E7

#### Operand Format and Number of States Required for Execution

Addressing Mode	Mnemonic	Operands	Instruction Format				No. of States
			1st byte	2nd byte	3rd byte	4th byte	
Register direct	SHAR.W	#2, Rd	1	1	D	rd	1

#### Notes

## 2.2.58 (5) SHAR (L)

### SHAR (SHift Arithmetic Right)

### Shift Arithmetic

#### Operation

ERd (right arithmetic shift) → ERd

#### Condition Code

I	UI	H	U	N	Z	V	C
—	—	—	—	↑	↑	0	↓

#### Assembly-Language Format

SHAR.L ERd

#### Operand Size

Longword

- H: Previous value remains unchanged.
- N: Set to 1 if the result is negative; otherwise cleared to 0.
- Z: Set to 1 if the result is zero; otherwise cleared to 0.
- V: Always cleared to 0.
- C: Receives the previous value in bit 0.

#### Description

This instruction shifts the bits in a 32-bit register ERd (destination operand) one bit to the right. Bit 0 shifts into the carry flag. Bit 31 shifts into itself. Since bit 31 remains unaltered, the sign does not change.

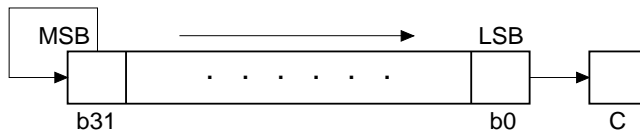

#### Available Registers

ERd: ER0 to ER7

#### Operand Format and Number of States Required for Execution

Addressing Mode	Mnemonic	Operands	Instruction Format				No. of States
			1st byte	2nd byte	3rd byte	4th byte	
Register direct	SHAR.L	ERd	1	1	B 0:erd		1

#### Notes

## 2.2.58 (6) SHAR (L)

### SHAR (SHift Arithmetic Right)

### Shift Arithmetic

#### Operation

ERd (right arithmetic shift) → ERd

#### Condition Code

I	UI	H	U	N	Z	V	C
—	—	—	—	↕	↕	0	↕

#### Assembly-Language Format

SHAR.L #2, ERd

- H: Previous value remains unchanged.
- N: Set to 1 if the result is negative; otherwise cleared to 0.
- Z: Set to 1 if the result is zero; otherwise cleared to 0.
- V: Always cleared to 0.
- C: Receives the previous value in bit 1.

#### Operand Size

Longword

#### Description

This instruction shifts the bits in a 32-bit register ERd (destination operand) two bits to the right. Bit 1 shifts into the carry flag. Bits 31 and 30 receive the previous value of bit 31. Since bit 31 remains unaltered, the sign does not change.

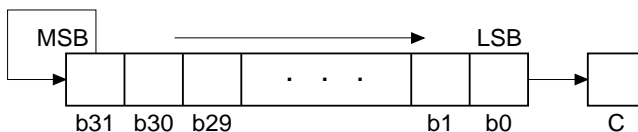

#### Available Registers

ERd: ER0 to ER7

#### Operand Format and Number of States Required for Execution

Addressing Mode	Mnemonic	Operands	Instruction Format				No. of States
			1st byte	2nd byte	3rd byte	4th byte	
Register direct	SHAR.L	#2, ERd	1	1	F	0:erd	1

#### Notes

## 2.2.59 (1) SHLL (B)

### SHLL (SHift Logical Left)

Shift Logical

#### Operation

Rd (left logical shift) → Rd

#### Condition Code

I	UI	H	U	N	Z	V	C
—	—	—	—	↑↓	↑↓	0	↑↓

#### Assembly-Language Format

SHLL.B Rd

#### Operand Size

Byte

- H: Previous value remains unchanged.
- N: Set to 1 if the result is negative; otherwise cleared to 0.
- Z: Set to 1 if the result is zero; otherwise cleared to 0.
- V: Always cleared to 0.
- C: Receives the previous value in bit 7.

#### Description

This instruction shifts the bits in an 8-bit register Rd (destination operand) one bit to the left. The most significant bit (bit 7) shifts into the carry flag. The least significant bit (bit 0) is cleared to 0.

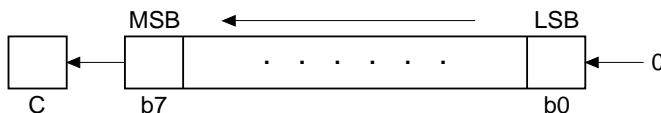

#### Available Registers

Rd: R0L to R7L, R0H to R7H

#### Operand Format and Number of States Required for Execution

Addressing Mode	Mnemonic	Operands	Instruction Format				No. of States
			1st byte	2nd byte	3rd byte	4th byte	
Register direct	SHLL.B	Rd	1 0	0 rd			1

#### Notes

The SHLL instruction differs from the SHAL instruction in its effect on the overflow flag.



## 2.2.59 (2) SHLL (B)

### SHLL (SHift Logical Left)

Shift Logical

#### Operation

Rd (left logical shift) → Rd

#### Condition Code

I	UI	H	U	N	Z	V	C
—	—	—	—	↕	↕	0	↕

#### Assembly-Language Format

SHLL .B #2, Rd

- H: Previous value remains unchanged.
- N: Set to 1 if the result is negative; otherwise cleared to 0.
- Z: Set to 1 if the result is zero; otherwise cleared to 0.
- V: Always cleared to 0.
- C: Receives the previous value in bit 6.

#### Operand Size

Byte

#### Description

This instruction shifts the bits in an 8-bit register Rd (destination operand) two bits to the left. Bit 6 shifts into the carry flag. Bits 0 and 1 are cleared to 0.

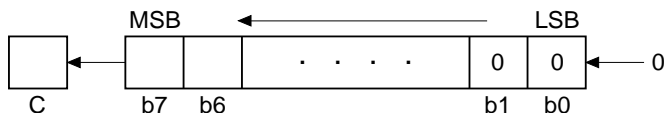

#### Available Registers

Rd: R0L to R7L, R0H to R7H

#### Operand Format and Number of States Required for Execution

Addressing Mode	Mnemonic	Operands	Instruction Format				No. of States
			1st byte	2nd byte	3rd byte	4th byte	
Register direct	SHLL.B	#2, Rd	1 ∴ 0	4 ∴ rd			1

#### Notes

The SHLL instruction differs from the SHAL instruction in its effect on the overflow flag.

## 2.2.59 (3) SHLL (W)

### SHLL (SHift Logical Left)

Shift Logical

#### Operation

Rd (left logical shift) → Rd

#### Condition Code

I	UI	H	U	N	Z	V	C
—	—	—	—	↑	↑	0	↓

#### Assembly-Language Format

SHLL.W Rd

#### Operand Size

Word

- H: Previous value remains unchanged.
- N: Set to 1 if the result is negative; otherwise cleared to 0.
- Z: Set to 1 if the result is zero; otherwise cleared to 0.
- V: Always cleared to 0.
- C: Receives the previous value in bit 15.

#### Description

This instruction shifts the bits in a 16-bit register Rd (destination operand) one bit to the left. The most significant bit (bit 15) shifts into the carry flag. The least significant bit (bit 0) is cleared to 0.

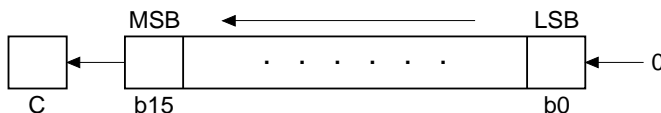

#### Available Registers

Rd: R0 to R7, E0 to E7

#### Operand Format and Number of States Required for Execution

Addressing Mode	Mnemonic	Operands	Instruction Format				No. of States
			1st byte	2nd byte	3rd byte	4th byte	
Register direct	SHLL.W	Rd	1	0	1	rd	1

#### Notes

The SHLL instruction differs from the SHAL instruction in its effect on the overflow flag.

## 2.2.59 (4) SHLL (W)

### SHLL (SHift Logical Left)

Shift Logical

#### Operation

Rd (left logical shift) → Rd

#### Condition Code

I	UI	H	U	N	Z	V	C
—	—	—	—	↕	↕	0	↕

#### Assembly-Language Format

SHLL .W #2, Rd

- H: Previous value remains unchanged.
- N: Set to 1 if the result is negative; otherwise cleared to 0.
- Z: Set to 1 if the result is zero; otherwise cleared to 0.
- V: Always cleared to 0.
- C: Receives the previous value in bit 14.

#### Operand Size

Word

#### Description

This instruction shifts the bits in a 16-bit register Rd (destination operand) two bits to the left. Bit 14 shifts into the carry flag. Bits 0 and 1 are cleared to 0.

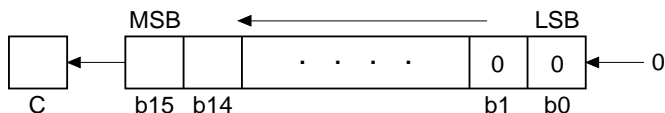

#### Available Registers

Rd: R0 to R7, E0 to E7

#### Operand Format and Number of States Required for Execution

Addressing Mode	Mnemonic	Operands	Instruction Format				No. of States
			1st byte	2nd byte	3rd byte	4th byte	
Register direct	SHLL.W	#2, Rd	1 0	5 rd			1

#### Notes

The SHLL instruction differs from the SHAL instruction in its effect on the overflow flag.

## 2.2.59 (5) SHLL (L)

### SHLL (SHift Logical Left)

Shift Logical

#### Operation

ERd (left logical shift) → ERd

#### Condition Code

I	UI	H	U	N	Z	V	C
—	—	—	—	↑	↑	0	↓

#### Assembly-Language Format

SHLL.L ERd

#### Operand Size

Longword

- H: Previous value remains unchanged.
- N: Set to 1 if the result is negative; otherwise cleared to 0.
- Z: Set to 1 if the result is zero; otherwise cleared to 0.
- V: Always cleared to 0.
- C: Receives the previous value in bit 31.

#### Description

This instruction shifts the bits in a 32-bit register ERd (destination operand) one bit to the left. The most significant bit (bit 31) shifts into the carry flag. The least significant bit (bit 0) is cleared to 0.

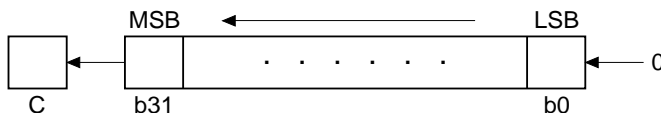

#### Available Registers

ERd: ER0 to ER7

#### Operand Format and Number of States Required for Execution

Addressing Mode	Mnemonic	Operands	Instruction Format				No. of States
			1st byte	2nd byte	3rd byte	4th byte	
Register direct	SHLL.L	ERd	1	0	3	0:erd	1

#### Notes

The SHLL instruction differs from the SHAL instruction in its effect on the overflow flag.

## 2.2.59 (6) SHLL (L)

### SHLL (SHift Logical Left)

Shift Logical

#### Operation

ERd (left logical shift) → ERd

#### Condition Code

I	UI	H	U	N	Z	V	C
—	—	—	—	↕	↕	0	↕

#### Assembly-Language Format

SHLL.L #2, ERd

#### Operand Size

Longword

- H: Previous value remains unchanged.
- N: Set to 1 if the result is negative; otherwise cleared to 0.
- Z: Set to 1 if the result is zero; otherwise cleared to 0.
- V: Always cleared to 0.
- C: Receives the previous value in bit 30.

#### Description

This instruction shifts the bits in a 32-bit register ERd (destination operand) two bits to the left. Bit 30 shifts into the carry flag. Bits 0 and 1 are cleared to 0.

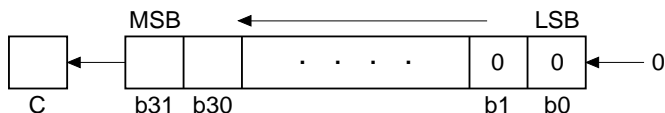

#### Available Registers

ERd: ER0 to ER7

#### Operand Format and Number of States Required for Execution

Addressing Mode	Mnemonic	Operands	Instruction Format				No. of States
			1st byte	2nd byte	3rd byte	4th byte	
Register direct	SHLL.L	#2, ERd	1 0	7 0:erd			1

#### Notes

The SHLL instruction differs from the SHAL instruction in its effect on the overflow flag.

## 2.2.60 (1) SHLR (B)

### SHLR (SHift Logical Right)

Shift Logical

#### Operation

Rd (right logical shift) → Rd

#### Condition Code

I	UI	H	U	N	Z	V	C
—	—	—	—	0	↕	0	↕

#### Assembly-Language Format

SHLR.B Rd

H: Previous value remains unchanged.

N: Always cleared to 0.

Z: Set to 1 if the result is zero; otherwise cleared to 0.

V: Always cleared to 0.

C: Receives the previous value in bit 0.

#### Operand Size

Byte

#### Description

This instruction shifts the bits in an 8-bit register Rd (destination operand) one bit to the right. The least significant bit (bit 0) shifts into the carry flag. The most significant bit (bit 7) is cleared to 0.

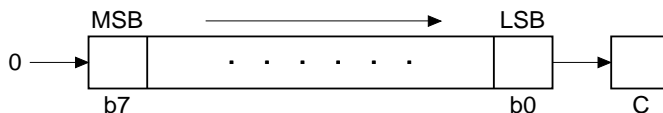

#### Available Registers

Rd: R0L to R7L, R0H to R7H

#### Operand Format and Number of States Required for Execution

Addressing Mode	Mnemonic	Operands	Instruction Format				No. of States
			1st byte	2nd byte	3rd byte	4th byte	
Register direct	SHLR.B	Rd	1	1	0	rd	1

#### Notes

## 2.2.60 (2) SHLR (B)

### SHLR (SHift Logical Right)

Shift Logical

#### Operation

Rd (right logical shift) → Rd

#### Condition Code

I	UI	H	U	N	Z	V	C
—	—	—	—	0	↑	0	↓

#### Assembly-Language Format

SHLR.B #2, Rd

H: Previous value remains unchanged.

N: Always cleared to 0.

Z: Set to 1 if the result is zero; otherwise cleared to 0.

V: Always cleared to 0.

C: Receives the previous value in bit 1.

#### Operand Size

Byte

#### Description

This instruction shifts the bits in an 8-bit register Rd (destination operand) two bits to the right. Bit 1 shifts into the carry flag. Bits 7 and 6 are cleared to 0.

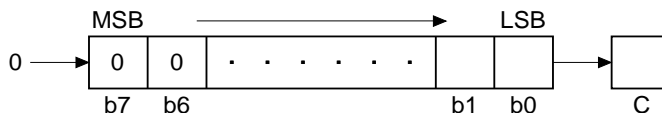

#### Available Registers

Rd: R0L to R7L, R0H to R7H

#### Operand Format and Number of States Required for Execution

Addressing Mode	Mnemonic	Operands	Instruction Format				No. of States
			1st byte	2nd byte	3rd byte	4th byte	
Register direct	SHLR.B	#2, Rd	1	4	rd		1

#### Notes

## 2.2.60 (3) SHLR (W)

### SHLR (SHift Logical Right)

Shift Logical

#### Operation

Rd (right logical shift) → Rd

#### Condition Code

I	UI	H	U	N	Z	V	C
—	—	—	—	0	↕	0	↕

#### Assembly-Language Format

SHLR.W Rd

H: Previous value remains unchanged.

N: Always cleared to 0.

Z: Set to 1 if the result is zero; otherwise cleared to 0.

V: Always cleared to 0.

C: Receives the previous value in bit 0.

#### Operand Size

Word

#### Description

This instruction shifts the bits in a 16-bit register Rd (destination operand) one bit to the right. The least significant bit (bit 0) shifts into the carry flag. The most significant bit (bit 15) is cleared to 0.

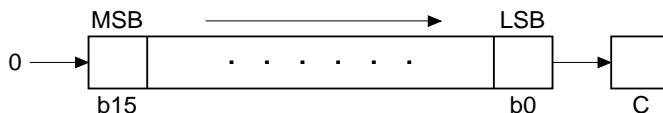

#### Available Registers

Rd: R0 to R7, E0 to E7

#### Operand Format and Number of States Required for Execution

Addressing Mode	Mnemonic	Operands	Instruction Format				No. of States
			1st byte	2nd byte	3rd byte	4th byte	
Register direct	SHLR.W	Rd	1	1	1	rd	1

#### Notes



## 2.2.60 (4) SHLR (W)

### SHLR (SHift Logical Right)

Shift Logical

#### Operation

Rd (right logical shift) → Rd

#### Condition Code

I	UI	H	U	N	Z	V	C
—	—	—	—	0	↑	0	↓

#### Assembly-Language Format

SHLR.W #2, Rd

H: Previous value remains unchanged.

N: Always cleared to 0.

Z: Set to 1 if the result is zero; otherwise cleared to 0.

V: Always cleared to 0.

C: Receives the previous value in bit 1.

#### Operand Size

Word

#### Description

This instruction shifts the bits in a 16-bit register Rd (destination operand) two bits to the right. Bit 1 shifts into the carry flag. Bits 15 and 14 are cleared to 0.

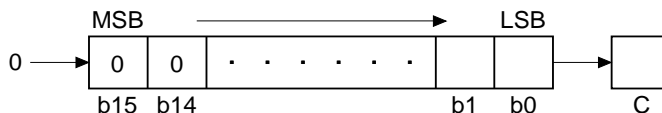

#### Available Registers

Rd: R0 to R7, E0 to E7

#### Operand Format and Number of States Required for Execution

Addressing Mode	Mnemonic	Operands	Instruction Format				No. of States
			1st byte	2nd byte	3rd byte	4th byte	
Register direct	SHLR.W	#2, Rd	1	5	rd		1

#### Notes

## 2.2.60 (5) SHLR (L)

### SHLR (SHift Logical Right)

Shift Logical

#### Operation

ERd (right logical shift) → ERd

#### Condition Code

I	UI	H	U	N	Z	V	C
—	—	—	—	0	↕	0	↕

#### Assembly-Language Format

SHLR.L ERd

H: Previous value remains unchanged.

N: Always cleared to 0.

Z: Set to 1 if the result is zero; otherwise cleared to 0.

V: Always cleared to 0.

C: Receives the previous value in bit 0.

#### Operand Size

Longword

#### Description

This instruction shifts the bits in a 32-bit register ERd (destination operand) one bit to the right. The least significant bit (bit 0) shifts into the carry flag. The most significant bit (bit 31) is cleared to 0.

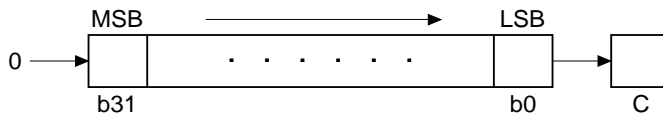

#### Available Registers

ERd: ER0 to ER7

#### Operand Format and Number of States Required for Execution

Addressing Mode	Mnemonic	Operands	Instruction Format				No. of States
			1st byte	2nd byte	3rd byte	4th byte	
Register direct	SHLR.L	ERd	1	1	3	0:erd	1

#### Notes

## 2.2.60 (6) SHLR (L)

### SHLR (SHift Logical Right)

Shift Logical

#### Operation

ERd (right logical shift) → ERd

#### Condition Code

I	UI	H	U	N	Z	V	C
—	—	—	—	0	↑	0	↓

#### Assembly-Language Format

SHLR.L #2, ERd

H: Previous value remains unchanged.

N: Always cleared to 0.

Z: Set to 1 if the result is zero; otherwise cleared to 0.

V: Always cleared to 0.

C: Receives the previous value in bit 1.

#### Operand Size

Longword

#### Description

This instruction shifts the bits in a 32-bit register ERd (destination operand) two bits to the right. Bit 1 shifts into the carry flag. Bits 31 and 30 are cleared to 0.

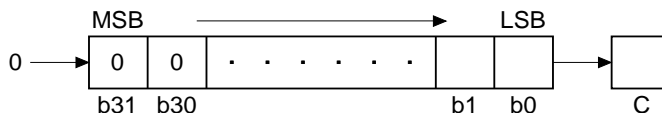

#### Available Registers

ERd: ER0 to ER7

#### Operand Format and Number of States Required for Execution

Addressing Mode	Mnemonic	Operands	Instruction Format				No. of States
			1st byte	2nd byte	3rd byte	4th byte	
Register direct	SHLR.L	#2, ERd	1	1	7	0:erd	1

#### Notes

## 2.2.61 SLEEP

### SLEEP (SLEEP)

### Power-Down Mode

---

#### Operation

Program execution state → power-down mode

#### Condition Code

I	UI	H	U	N	Z	V	C
—	—	—	—	—	—	—	—

---

#### Assembly-Language Format

SLEEP

- H: Previous value remains unchanged.  
N: Previous value remains unchanged.  
Z: Previous value remains unchanged.  
V: Previous value remains unchanged.  
C: Previous value remains unchanged.

---

#### Operand Size

—

---

#### Description

When the SLEEP instruction is executed, the CPU enters a power-down mode. Its internal state remains unchanged, but the CPU stops executing instructions and waits for an exception-handling request. When it receives an exception-handling request, the CPU exits the power-down mode and begins the exception-handling sequence. Interrupt requests other than NMI cannot end the power-down mode if they are masked in the CPU.

---

#### Available Registers

—

---

#### Operand Format and Number of States Required for Execution

Addressing Mode	Mnemonic	Operands	Instruction Format				No. of States	
			1st byte	2nd byte	3rd byte	4th byte		
—	SLEEP		0	1	8	0		2

---

#### Notes

For information about power-down modes, see the relevant microcontroller hardware manual.

## 2.2.62 (1) STC (B)

STC (STore from Control register)

Store CCR

### Operation

CCR → Rd

### Condition Code

I	UI	H	U	N	Z	V	C
—	—	—	—	—	—	—	—

### Assembly-Language Format

STC .B CCR, Rd

H: Previous value remains unchanged.  
N: Previous value remains unchanged.  
Z: Previous value remains unchanged.  
V: Previous value remains unchanged.  
C: Previous value remains unchanged.

### Operand Size

Byte

### Description

This instruction copies the CCR contents to an 8-bit register Rd.

### Available Registers

Rd: R0L to R7L, R0H to R7H

### Operand Format and Number of States Required for Execution

Addressing Mode	Mnemonic	Operands	Instruction Format				No. of States
			1st byte	2nd byte	3rd byte	4th byte	
Register direct	STC.B	CCR, Rd	0   2	0   rd			1

### Notes

## 2.2.62 (2) STC (B)

STC (STore from Control register)

Store EXR

---

### Operation

EXR → Rd

### Condition Code

I	UI	H	U	N	Z	V	C
—	—	—	—	—	—	—	—

---

### Assembly-Language Format

STC.B EXR, Rd

- H: Previous value remains unchanged.
- N: Previous value remains unchanged.
- Z: Previous value remains unchanged.
- V: Previous value remains unchanged.
- C: Previous value remains unchanged.

---

### Operand Size

Byte

---

### Description

This instruction copies the EXR contents to an 8-bit register Rd.

---

### Available Registers

Rd: R0L to R7L, R0H to R7H

---

### Operand Format and Number of States Required for Execution

Addressing Mode	Mnemonic	Operands	Instruction Format				No. of States
			1st byte	2nd byte	3rd byte	4th byte	
Register direct	STC.B	EXR, Rd	0 2	1 rd			1

---

### Notes

## 2.2.62 (3) STC (W)

STC (STore from Control register)

Store CCR

---

### Operation

CCR → (EAd)

### Condition Code

I	UI	H	U	N	Z	V	C
—	—	—	—	—	—	—	—

---

### Assembly-Language Format

STC .W CCR, <EAd>

H: Previous value remains unchanged.

N: Previous value remains unchanged.

Z: Previous value remains unchanged.

V: Previous value remains unchanged.

C: Previous value remains unchanged.

---

### Operand Size

Word

---

### Description

This instruction copies the CCR contents to a destination location. Although CCR is a byte register, the destination operand is a word operand. The CCR contents are stored at the even address. Undetermined data is stored at the odd address.

---

### Available Registers

ERd: ER0 to ER7

Operand Format and Number of States Required for Execution

Addressing Mode	Mnemonic	Operands	Instruction Format										No. of States				
			1st byte	2nd byte	3rd byte	4th byte	5th byte	6th byte	7th byte	8th byte	9th byte	10th byte					
Register indirect	STC.W	CCR, @ERd	0	1	4	0	6	9	1:erd	0							3
Register indirect with displacement	STC.W	CCR, @(d:16, ERd)	0	1	4	0	6	F	1:erd	0	disp						4
Register indirect with pre-increment	STC.W	CCR, @(d:32, ERd)	0	1	4	0	7	8	0:erd	0	6	B	A	0	disp		6
Register indirect with pre-decrement	STC.W	CCR, @-ERd	0	1	4	0	6	D	1:erd	0							4
Absolute address	STC.W	CCR, @aa:16	0	1	4	0	6	B	8	0	abs						4
	STC.W	CCR, @aa:32	0	1	4	0	6	B	A	0				abs			5

Notes



## 2.2.62 (4) STC (W)

STC (STore from Control register)

Store EXR

---

### Operation

EXR → (EAd)

### Condition Code

I	UI	H	U	N	Z	V	C
—	—	—	—	—	—	—	—

---

### Assembly-Language Format

STC .w EXR, <EAd>

H: Previous value remains unchanged.  
N: Previous value remains unchanged.  
Z: Previous value remains unchanged.  
V: Previous value remains unchanged.  
C: Previous value remains unchanged.

---

### Operand Size

Word

---

### Description

This instruction copies the EXR contents to a destination location. Although EXR is a byte register, the destination operand is a word operand. The EXR contents are stored at the even address. Undetermined data is stored at the odd address.

---

### Available Registers

ERd: ER0 to ER7

Operand Format and Number of States Required for Execution

Addressing Mode	Mnemonic	Operands	Instruction Format										No. of States				
			1st byte	2nd byte	3rd byte	4th byte	5th byte	6th byte	7th byte	8th byte	9th byte	10th byte					
Register indirect	STC.W	EXR, @ERd	0	1	4	1	6	9	1:erd	0							3
Register indirect with displacement	STC.W	EXR, @(d:16, ERd)	0	1	4	1	6	F	1:erd	0	disp						4
Register indirect with pre-increment	STC.W	EXR, @(d:32, ERd)	0	1	4	1	7	8	0:erd	0	6	B	A	0	disp		6
Register indirect with pre-decrement	STC.W	EXR, @-ERd	0	1	4	1	6	D	1:erd	0							4
Absolute address	STC.W	EXR, @aa:16	0	1	4	1	6	B	8	0	abs						4
	STC.W	EXR, @aa:32	0	1	4	1	6	B	A	0				abs			5

Notes

## 2.2.63 STM

### STM (STore from Multiple registers)

Store Data on Stack

---

#### Operation

ERn (register list) → @-SP

#### Condition Code

I	UI	H	U	N	Z	V	C
—	—	—	—	—	—	—	—

---

#### Assembly-Language Format

STM.L <register list>, @-SP

H: Previous value remains unchanged.

N: Previous value remains unchanged.

Z: Previous value remains unchanged.

V: Previous value remains unchanged.

C: Previous value remains unchanged.

---

#### Operand Size

Longword

---

#### Description

This instruction saves a group of registers specified by a register list onto the stack. The registers are saved in ascending order of register number.

Two, three, or four registers can be saved by one STM instruction. The following ranges can be specified in the register list.

Two registers: ER0-ER1, ER2-ER3, ER4-ER5, or ER6-ER7

Three registers: ER0-ER2 or ER4-ER6

Four registers: ER0-ER3 or ER4-ER7

---

#### Available Registers

ERn: ER0 to ER7

---

**Operand Format and Number of States Required for Execution**

Addressing Mode	Mnemonic	Operands	Instruction Format								No. of States
			1st byte		2nd byte		3rd byte		4th byte		
—	STM.L	(ERn-ERn+1), @-SP	0	1	1	0	6	D	F	0:ern	7
—	STM.L	(ERn-ERn+2), @-SP	0	1	2	0	6	D	F	0:ern	9
—	STM.L	(ERn-ERn+3), @-SP	0	1	3	0	6	D	F	0:ern	11

---

**Notes**

When ER7 is saved, the value after effective address calculation (after ER7 is decremented by 4) is saved on the stack.

## 2.2.64 STMAC

### STMAC (STore from MAC register)

### Store Data from MAC Register

---

#### Operation

MACH → ERd

or

MACL → ERd

---

#### Assembly-Language Format

STMAC MAC register, ERd

---

#### Operand Size

Longword

#### Condition Code

I	UI	H	U	N	Z	V	C
—	—	—	—	↕*	↕*	↕*	—

H: Previous value remains unchanged.

N: Set to 1 if a MAC instruction resulted in a negative MAC register value; otherwise cleared to 0.

Z: Set to 1 if a MAC instruction resulted in a zero MAC register value; otherwise cleared to 0.

V: Set to 1 if a MAC instruction resulted in an overflow; otherwise cleared to 0.

C: Previous value remains unchanged.

Note: \* Execution of this instruction copies the N, Z, and V flag values from the multiplier to the condition-code register (CCR). If the STMAC instruction is executed after a CLRMAC or LDMAC instruction with no intervening MAC instruction, the V flag will be 0 and the N and Z flags will have undetermined values.

---

#### Description

This instruction moves the contents of a multiply-accumulate register (MACH or MACL) to a general register. If the transfer is from MACH, the upper 22 bits transferred to the general register are a sign extension.

This instruction is supported by the H8S/2600 CPU only.

---

#### Available Registers

ERd: ER0 to ER7

**Operand Format and Number of States Required for Execution**

Addressing Mode	Mnemonic	Operands	Instruction Format				No. of States
			1st byte	2nd byte	3rd byte	4th byte	
Register direct	STMAC	MACH, ERd	0	2	2	0:ers	1*
Register direct	STMAC	MACL, ERd	0	2	3	0:ers	1*

Note: \* A maximum of three additional states are required for execution of this instruction within three states after execution of a MAC instruction. For example, if there is a one-state instruction (such as NOP) between the MAC instruction and this instruction, this instruction will be two states longer.

**Notes**

## 2.2.65 (1) SUB (B)

### SUB (SUBtract binary)

### Subtract Binary

#### Operation

Rd – Rs → Rd

#### Condition Code

I	UI	H	U	N	Z	V	C
—	—	↕	—	↕	↕	↕	↕

#### Assembly-Language Format

SUB .B Rs, Rd

#### Operand Size

Byte

- H: Set to 1 if there is a borrow at bit 3; otherwise cleared to 0.
- N: Set to 1 if the result is negative; otherwise cleared to 0.
- Z: Set to 1 if the result is zero; otherwise cleared to 0.
- V: Set to 1 if an overflow occurs; otherwise cleared to 0.
- C: Set to 1 if there is a borrow at bit 7; otherwise cleared to 0.

#### Description

This instruction subtracts the contents of an 8-bit register Rs (source operand) from the contents of an 8-bit register Rd (destination operand) and stores the result in the 8-bit register Rd.

#### Available Registers

Rd: R0L to R7L, R0H to R7H

Rs: R0L to R7L, R0H to R7H

#### Operand Format and Number of States Required for Execution

Addressing Mode	Mnemonic	Operands	Instruction Format				No. of States
			1st byte	2nd byte	3rd byte	4th byte	
Register direct	SUB.B	Rs, Rd	1	8	rs	rd	1

**Notes**

The SUB.B instruction can operate only on general registers. Immediate data can be subtracted from general register contents by using the SUBX instruction. Before executing SUBX #xx:8, Rd, first set the Z flag to 1 and clear the C flag to 0. The following coding examples can also be used to subtract nonzero immediate data #IMM.

- (1) ORC     #H'05,CCR  
      SUBX  #(IMM-1),Rd
- (2) ADD     #(0-IMM),Rd  
      XORC  #H'01,CCR



## 2.2.65 (2) SUB (W)

### SUB (SUBtract binary)

### Subtract Binary

#### Operation

Rd – (EAs) → Rd

#### Condition Code

I	UI	H	U	N	Z	V	C
—	—	↕	—	↕	↕	↕	↕

#### Assembly-Language Format

SUB.W <EAs>, Rd

#### Operand Size

Word

- H: Set to 1 if there is a borrow at bit 11; otherwise cleared to 0.
- N: Set to 1 if the result is negative; otherwise cleared to 0.
- Z: Set to 1 if the result is zero; otherwise cleared to 0.
- V: Set to 1 if an overflow occurs; otherwise cleared to 0.
- C: Set to 1 if there is a borrow at bit 15; otherwise cleared to 0.

#### Description

This instruction subtracts a source operand from the contents of a 16-bit register Rd (destination operand) and stores the result in the 16-bit register Rd.

#### Available Registers

Rd: R0 to R7, E0 to E7

Rs: R0 to R7, E0 to E7

#### Operand Format and Number of States Required for Execution

Addressing Mode	Mnemonic	Operands	Instruction Format				No. of States
			1st byte	2nd byte	3rd byte	4th byte	
Immediate	SUB.W	#xx:16, Rd	7   9	3   rd	IMM		2
Register direct	SUB.W	Rs, Rd	1   9	rs   rd			1

#### Notes

## 2.2.65 (3) SUB (L)

### SUB (SUBtract binary)

### Subtract Binary

#### Operation

ERd – (EAs) → ERd

#### Condition Code

I	UI	H	U	N	Z	V	C
—	—	↕	—	↕	↕	↕	↕

#### Assembly-Language Format

SUB.L <EAs>, ERd

- H: Set to 1 if there is a borrow at bit 27; otherwise cleared to 0.
- N: Set to 1 if the result is negative; otherwise cleared to 0.
- Z: Set to 1 if the result is zero; otherwise cleared to 0.
- V: Set to 1 if an overflow occurs; otherwise cleared to 0.
- C: Set to 1 if there is a borrow at bit 31; otherwise cleared to 0.

#### Operand Size

Longword

#### Description

This instruction subtracts a source operand from the contents of a 32-bit register ERd (destination operand) and stores the result in the 32-bit register ERd.

#### Available Registers

ERd: ER0 to ER7

ERs: ER0 to ER7

#### Operand Format and Number of States Required for Execution

Addressing Mode	Mnemonic	Operands	Instruction Format						No. of States	
			1st byte		2nd byte		3rd byte	4th byte		5th byte
Immediate	SUB.L	#xx:32, ERd	7	A	3	0:erd	IMM			3
Register direct	SUB.L	ERs, ERd	1	A	1:ers	0:erd				1

#### Notes

## 2.2.66 SUBS

### SUBS (SUBtract with Sign extension)

### Subtract Binary Address Data

#### Operation

Rd - 1 → ERd

Rd - 2 → ERd

Rd - 4 → ERd

#### Condition Code

I	UI	H	U	N	Z	V	C
—	—	—	—	—	—	—	—

#### Assembly-Language Format

SUBS #1, ERd

SUBS #2, ERd

SUBS #4, ERd

H: Previous value remains unchanged.

N: Previous value remains unchanged.

Z: Previous value remains unchanged.

V: Previous value remains unchanged.

C: Previous value remains unchanged.

#### Operand Size

Longword

#### Description

This instruction subtracts the immediate value 1, 2, or 4 from the contents of a 32-bit register ERd (destination operand). Unlike the SUB instruction, it does not affect the condition-code flags.

#### Available Registers

ERd: ER0 to ER7

#### Operand Format and Number of States Required for Execution

Addressing Mode	Mnemonic	Operands	Instruction Format				No. of States
			1st byte	2nd byte	3rd byte	4th byte	
Register direct	SUBS	#1, ERd	1	B	0	0:erd	1
Register direct	SUBS	#2, ERd	1	B	8	0:erd	1
Register direct	SUBS	#4, ERd	1	B	9	0:erd	1

#### Notes

## 2.2.67 SUBX

**SUBX (SUBtract with eXtend carry)**

**Subtract with Borrow**

### Operation

$Rd - (EAs) - C \rightarrow Rd$

### Condition Code

I	UI	H	U	N	Z	V	C
—	—	↕	—	↕	↕	↕	↕

### Assembly-Language Format

SUBX <EAs>, Rd

### Operand Size

Byte

- H: Set to 1 if there is a borrow at bit 3; otherwise cleared to 0.
- N: Set to 1 if the result is negative; otherwise cleared to 0.
- Z: Previous value remains unchanged when the result is zero; otherwise cleared to 0.
- V: Set to 1 if an overflow occurs; otherwise cleared to 0.
- C: Set to 1 if there is a borrow at bit 7; otherwise cleared to 0.

### Description

This instruction subtracts the source operand and carry flag from the contents of an 8-bit register Rd (destination operand) and stores the result in the 8-bit register Rd.

### Available Registers

Rd: R0L to R7L, R0H to R7H

### Operand Format and Number of States Required for Execution

Addressing Mode	Mnemonic	Operands	Instruction Format				No. of States
			1st byte	2nd byte	3rd byte	4th byte	
Immediate	SUBX	#xx:8, Rd	B	rd	IMM		1
Register direct	SUBX	Rs, Rd	1	E	rs	rd	1

### Notes

**Operation**

@ERd – 0 → set/clear CCR  
 1 → (<bit 7> of @ERd)

**Condition Code**

I	UI	H	U	N	Z	V	C
—	—	—	—	↕	↕	0	—

**Assembly-Language Format**

TAS @ERd

- H: Previous value remains unchanged.  
 N: Set to 1 if the result is negative; otherwise cleared to 0.  
 Z: Set to 1 if the result is zero; otherwise cleared to 0.  
 V: Always cleared to 0.  
 C: Previous value remains unchanged.

**Operand Size**

Byte

**Description**

This instruction tests a memory operand by comparing it with zero, and sets the condition-code register according to the result. Then it sets the most significant bit (bit 7) of the operand to 1.

**Available Registers**

ERd: ER0, ER1, ER4, ER5

**Operand Format and Number of States Required for Execution**

Addressing Mode	Mnemonic	Operands	Instruction Format								No. of States	
			1st byte		2nd byte		3rd byte		4th byte			
Register indirect	TAS	@ERd	0	1	E	0	7	B	0	erd	C	4

**Notes**

## 2.2.69 TRAPA

### TRAPA (TRAP Always)

### Trap Unconditionally

#### Operation

- When EXR is invalid  
PC → @-SP  
CCR → @-SP  
<Vector> → PC
- When EXR is valid  
PC → @-SP  
CCR → @-SP  
EXR → @-SP  
<Vector> → PC

#### Condition Code

I	UI	H	U	N	Z	V	C
1	*	—	—	—	—	—	—

I: Always set to 1.

UI: See note.

H: Previous value remains unchanged.

N: Previous value remains unchanged.

Z: Previous value remains unchanged.

V: Previous value remains unchanged.

C: Previous value remains unchanged.

#### Assembly-Language Format

TRAPA #x:2

Note: \* The UI bit is set to 1 when used as an interrupt mask bit, but retains its previous value when used as a user bit. For details, see the relevant microcontroller hardware manual.

#### Operand Size

—

#### Description

This instruction pushes the program counter (PC) and condition-code register (CCR) onto the stack, then sets the I bit to 1. If the extended control register (EXR) is valid, EXR is also saved onto the stack, but bits I2 to I0 are not modified. Next execution branches to a new address given by the contents of the vector address corresponding to the specified vector number. The PC value pushed onto the stack is the starting address of the next instruction after the TRAPA instruction.

#x	Vector Address	
	Normal Mode	Advanced Mode
0	H'0010 to H'0011	H'000020 to H'000023
1	H'0012 to H'0013	H'000024 to H'000027
2	H'0014 to H'0015	H'000028 to H'00002B
3	H'0016 to H'0017	H'00002C to H'00002F

---

**Operand Format and Number of States Required for Execution**

Addressing Mode	Mnemonic	Operands	Instruction Format				No. of States
			1st byte	2nd byte	3rd byte	4th byte	
Register direct	TRAPA	#x:2	5	7	00IMM 0		7*

Note: \* Eight states when EXR is valid.

---

**Notes**

The stack and vector structure differ between normal mode and advanced mode, and depending on whether EXR is valid or invalid.

## 2.2.70 (1) XOR (B)

### XOR (eXclusive OR logical)

### Exclusive Logical OR

---

#### Operation

$Rd \oplus (EAs) \rightarrow Rd$

#### Condition Code

I	UI	H	U	N	Z	V	C
—	—	—	—	↑	↓	0	—

---

#### Assembly-Language Format

`XOR.B <EAs>, Rd`

- H: Previous value remains unchanged.  
N: Set to 1 if the result is negative; otherwise cleared to 0.  
Z: Set to 1 if the result is zero; otherwise cleared to 0.  
V: Always cleared to 0.  
C: Previous value remains unchanged.

---

#### Operand Size

Byte

---

#### Description

This instruction exclusively ORs the source operand with the contents of an 8-bit register Rd (destination operand) and stores the result in the 8-bit register Rd.

---

#### Available Registers

Rd: R0L to R7L, R0H to R7H

Rs: R0L to R7L, R0H to R7H

---

#### Operand Format and Number of States Required for Execution

Addressing Mode	Mnemonic	Operands	Instruction Format				No. of States
			1st byte	2nd byte	3rd byte	4th byte	
Immediate	XOR.B	#xx:8, Rd	D	rd	IMM		1
Register direct	XOR.B	Rs, Rd	1	5	rs	rd	1

---

#### Notes



## 2.2.70 (2) XOR (W)

### XOR (eXclusive OR logical)

### Exclusive Logical OR

#### Operation

$Rd \oplus (EAs) \rightarrow Rd$

#### Condition Code

I	UI	H	U	N	Z	V	C
—	—	—	—	↕	↕	0	—

#### Assembly-Language Format

XOR.W <EAs>, Rd

H: Previous value remains unchanged.

N: Set to 1 if the result is negative; otherwise cleared to 0.

Z: Set to 1 if the result is zero; otherwise cleared to 0.

V: Always cleared to 0.

C: Previous value remains unchanged.

#### Operand Size

Word

#### Description

This instruction exclusively ORs the source operand with the contents of a 16-bit register Rd (destination operand) and stores the result in the 16-bit register Rd.

#### Available Registers

Rd: R0 to R7, E0 to E7

Rs: R0 to R7, E0 to E7

#### Operand Format and Number of States Required for Execution

Addressing Mode	Mnemonic	Operands	Instruction Format				No. of States	
			1st byte	2nd byte	3rd byte	4th byte		
Immediate	XOR.W	#xx:16, Rd	7	9	5	rd	IMM	2
Register direct	XOR.W	Rs, Rd	6	5	rs	rd		1

#### Notes

## 2.2.70 (3) XOR (L)

### XOR (eXclusive OR logical)

### Exclusive Logical OR

#### Operation

$ERd \oplus (EAs) \rightarrow ERd$

#### Condition Code

I	UI	H	U	N	Z	V	C
—	—	—	—	↑	↓	0	—

#### Assembly-Language Format

`XOR.L <EAs>, ERd`

#### Operand Size

Longword

- H: Previous value remains unchanged.
- N: Set to 1 if the result is negative; otherwise cleared to 0.
- Z: Set to 1 if the result is zero; otherwise cleared to 0.
- V: Always cleared to 0.
- C: Previous value remains unchanged.

#### Description

This instruction exclusively ORs the source operand with the contents of a 32-bit register ERd (destination operand) and stores the result in the 32-bit register ERd.

#### Available Registers

ERd: ER0 to ER7

ERs: ER0 to ER7

#### Operand Format and Number of States Required for Execution

Addressing Mode	Mnemonic	Operands	Instruction Format						No. of States		
			1st byte		2nd byte		3rd byte	4th byte		5th byte	6th byte
Immediate	XOR.L	#xx:32, ERd	7	A	5	0:erd	IMM			3	
Register direct	XOR.L	ERs, ERd	0	1	F	0	6	5	0:ers	0:erd	2

#### Notes

## 2.2.71 (1) XORC

### XORC (eXclusive OR Control register)

### Exclusive Logical OR with CCR

#### Operation

CCR  $\oplus$  #IMM  $\rightarrow$  CCR

#### Condition Code

I	UI	H	U	N	Z	V	C
↕	↕	↕	↕	↕	↕	↕	↕

#### Assembly-Language Format

XORC #xx:8, CCR

#### Operand Size

Byte

- I: Stores the corresponding bit of the result.
- UI: Stores the corresponding bit of the result.
- H: Stores the corresponding bit of the result.
- U: Stores the corresponding bit of the result.
- N: Stores the corresponding bit of the result.
- Z: Stores the corresponding bit of the result.
- V: Stores the corresponding bit of the result.
- C: Stores the corresponding bit of the result.

#### Description

This instruction exclusively ORs the contents of the condition-code register (CCR) with immediate data and stores the result in the condition-code register. No interrupt requests, including NMI, are accepted immediately after execution of this instruction.

#### Operand Format and Number of States Required for Execution

Addressing Mode	Mnemonic	Operands	Instruction Format				No. of States
			1st byte	2nd byte	3rd byte	4th byte	
Immediate	XORC	#xx:8, CCR	0	5	IMM		1

#### Notes

## 2.2.71 (2) XORC

### XORC (eXclusive OR Control register)

### Exclusive Logical OR with EXR

#### Operation

$EXR \oplus \#IMM \rightarrow EXR$

#### Condition Code

I	UI	H	U	N	Z	V	C
—	—	—	—	—	—	—	—

#### Assembly-Language Format

XORC #xx:8, EXR

- H: Previous value remains unchanged.
- N: Previous value remains unchanged.
- Z: Previous value remains unchanged.
- V: Previous value remains unchanged.
- C: Previous value remains unchanged.

#### Operand Size

Byte

#### Description

This instruction exclusively ORs the contents of the extended control register (EXR) with immediate data and stores the result in the extended control register. No interrupt requests, including NMI, are accepted for three states after execution of this instruction.

#### Operand Format and Number of States Required for Execution

Addressing Mode	Mnemonic	Operands	Instruction Format				No. of States
			1st byte	2nd byte	3rd byte	4th byte	
Immediate	XORC	#xx:8, EXR	0   1	4   1	0   5	IMM	2

#### Notes

# 2.3 Instruction Set

Table 2.1 Instruction Set

(1) Data Transfer Instructions

Mnemonic	Size	Addressing Mode and Instruction Length (Bytes)						Operation	Condition Code						No. of States*1			
		#xx	Rn	@ERn	(d,ERn)	-ERn/@ERn+	@aa		(d,PC)	@aa	I	H	N	Z	V	C	Normal	Advanced
MOV	B	2														1		
MOV.B #xx:8,Rd	B																	
MOV.B Rs,Rd	B	2																
MOV.B @ERS,Rd	B		2															
MOV.B @(d:16,ERS),Rd	B			4														
MOV.B @(d:32,ERS),Rd	B			8														
MOV.B @ERs+,Rd	B				2													
MOV.B @aa:8,Rd	B					2												
MOV.B @aa:16,Rd	B					4												
MOV.B @aa:32,Rd	B					6												
MOV.B Rs,@ERd	B		2															
MOV.B Rs,@(d:16,ERd)	B			4														
MOV.B Rs,@(d:32,ERd)	B			8														
MOV.B Rs,@-ERd	B				2													
MOV.B Rs,@aa:8	B					2												
MOV.B Rs,@aa:16	B					4												
MOV.B Rs,@aa:32	B					6												
MOV.W #xx:16,Rd	W	4																
MOV.W Rs,Rd	W		2															
MOV.W @ERS,Rd	W			2														
MOV.W @(d:16,ERS),Rd	W			4														
MOV.W @(d:32,ERS),Rd	W			8														
MOV.W @ERS+,Rd	W				2													
MOV.W @aa:16,Rd	W					4												
MOV.W @aa:32,Rd	W					6												
MOV.W Rs,@ERd	W			2														
MOV.W Rs,@(d:16,ERd)	W			4														
MOV.W Rs,@(d:32,ERd)	W			8														
MOV.W Rs,@-ERd	W				2													
MOV.W Rs,@aa:16	W					4												
MOV.W Rs,@aa:32	W					6												



## (2) Arithmetic Operation Instructions

Mnemonic	Size	Addressing Mode and Instruction Length (Bytes)						Operation	Condition Code						No. of States*1			
		#xx	Rn	@ERn	@ (d,ERn)	@-ERn/@ERn+	@aa		@ (d,P,C)	@aa	I	H	N	Z	V	C	Normal	Advanced
ADD	ADD.B #xx:8,Rd	B	2														1	
	ADD.B Rs,Rd	B	2														1	
ADDX	ADD.W #xx:16,Rd	W	4														2	
	ADD.W Rs,Rd	W	2														1	
	ADD.L #xx:32,ERd	L	6														3	
	ADD.L ERs,ERd	L	2														1	
	ADDX #xx:8,Rd	B	2														1	
	ADDX Rs,Rd	B	2														1	
ADDS	ADDS #1,ERd	L	2														1	
	ADDS #2,ERd	L	2														1	
	ADDS #4,ERd	L	2														1	
	INC.B Rd	B	2														1	
	INC.W #1,Rd	W	2														1	
	INC.W #2,Rd	W	2														1	
DAA	INC.L #1,ERd	L	2														1	
	INC.L #2,ERd	L	2														1	
	DAA Rd	B	2														1	
	SUB.B Rs,Rd	B	2														1	
	SUB.W #xx:16,Rd	W	4														2	
	SUB.W Rs,Rd	W	2														1	
SUBX	SUB.L #xx:32,ERd	L	6														3	
	SUB.L ERs,ERd	L	2														1	
	SUBX #xx:8,Rd	B	2														1	
	SUBX Rs,Rd	B	2														1	
	SUBS #1,ERd	L	2														1	
	SUBS #2,ERd	L	2														1	
DEC	SUBS #4,ERd	L	2														1	
	DEC.B Rd	B	2														1	
	DEC.W #1,Rd	W	2														1	
	DEC.W #2,Rd	W	2														1	
	DEC.L #1,ERd	L	2														1	
	DEC.L #2,ERd	L	2														1	

Mnemonic	Size		Addressing Mode and Instruction Length (Bytes)					Operation	Condition Code							No. of States*1	
	#xx	Rn	@ERn	@ (d,ERn)	@-ERn/ERn+	@aa	@ (d,PC)		@aa	I	H	Z	N	V	C		Normal
DAS	DAS Rd	B	2								*	↑	↓	*	1		
MULXU	MULXU.B Rs,Rd	B	2								—	—	—	—	3 (12*7) #4		
	MULXU.W Rs,ERd	W	2								—	—	—	—	4 (20*7) #4		
MULXS	MULXS.B Rs,Rd	B	4								—	—	—	—	4 (13*7) #5		
	MULXS.W Rs,ERd	W	4								—	—	—	—	5 (21*7) #5		
DIVXU	DIVXU.B Rs,Rd	B	2								—	—	—	—	12		
	DIVXU.W Rs,ERd	W	2								—	—	—	—	20		
DIVXS	DIVXS.B Rs,Rd	B	4								—	—	—	—	13		
	DIVXS.W Rs,ERd	W	4								—	—	—	—	21		
CMP	CMP #xx:8,Rd	B	2								—	—	—	—	1		
	CMP Rs,Rd	B	2								—	—	—	—	1		
NEG	NEG.W Rd	W	2								—	—	—	—	1		
	NEG.L ERd	L	2								—	—	—	—	1		
EXTU	EXTU.W Rd	W	2								—	—	—	—	1		
	EXTU.L ERd	L	2								—	—	—	—	1		
EXTS	EXTS.W Rd	W	2								—	—	—	—	1		
	EXTS.L ERd	L	2								—	—	—	—	1		
TAS	TAS @ERd <sup>#8</sup>	B		4							—	—	—	—	4		



Mnemonic	Size	Addressing Mode and Instruction Length (Bytes)								Operation	Condition Code						No. of States <sup>*1</sup>		
		#xx	Rn	@ERn	@{d,ERn}	@-ERn/@ERn+	@aa	@{d,PC}	@aa		I	I	H	N	Z	V	C	Normal	Advanced
																		4	2
MAC <sup>*9</sup>	—																	4	
CLRMAC <sup>*9</sup>	—																	2 <sup>*6</sup>	
LDMAC <sup>*9</sup>	L	2																2 <sup>*6</sup>	
LDMAC ERs,MACL	L	2																2 <sup>*6</sup>	
STMAC <sup>*9</sup>	L	2																1 <sup>*6</sup>	
STMAC MACL,ERd	L	2																1 <sup>*6</sup>	

### (3) Logic Operation Instructions

Mnemonic	Size	Addressing Mode and Instruction Length (Bytes)						Operation	Condition Code						No. of States <sup>*1</sup>			
		#xx	Fn	@ERn	@(d,ERn)	@-ERn/@ERn+	@aa		@(d,PC)	@aa	I	H	N	Z	V	C	Normal	Advanced
AND	AND.B #xx:8,Rd	B	2															1
	AND.B Rs,Rd	B	2															1
	AND.W #xx:16,Rd	W	4															2
	AND.W Rs,Rd	W	2															1
	AND.L #xx:32,ERd	L	6															3
	AND.L ERs,ERd	L	4															2
OR	OR.B #xx:8,Rd	B	2															1
	OR.B Rs,Rd	B	2															1
	OR.W #xx:16,Rd	W	4															2
	OR.W Rs,Rd	W	2															1
	OR.L #xx:32,ERd	L	6															3
	OR.L ERs,ERd	L	4															2
XOR	XOR.B #xx:8,Rd	B	2															1
	XOR.B Rs,Rd	B	2															1
	XOR.W #xx:16,Rd	W	4															2
	XOR.W Rs,Rd	W	2															1
	XOR.L #xx:32,ERd	L	6															3
	XOR.L ERs,ERd	L	4															2
NOT	NOT.B Rd	B	2															1
	NOT.W Rd	W	2															1
	NOT.L ERd	L	2															1

#### (4) Shift Instructions

Mnemonic	Size	Addressing Mode and Instruction Length (Bytes)						Operation	Condition Code						No. of States <sup>*)1</sup>		
		#xx	Rn	@ERn	@(d,ERn)	@-ERn/@ERn+	@aa		@(d,PC)	@aa	I	H	N	Z	V	C	Normal
SHAL	SHAL.B Rd		2													1	
	SHAL.B #2,Rd	B	2													1	
	SHAL.W Rd	W	2													1	
	SHAL.W #2,Rd	W	2													1	
	SHAL.L ERd	L	2													1	
SHAR	SHAL.L #2,ERd	L	2													1	
	SHAR.B Rd	B	2													1	
	SHAR.B #2,Rd	B	2													1	
	SHAR.W Rd	W	2													1	
	SHAR.W #2,Rd	W	2													1	
SHLL	SHAR.L ERd	L	2													1	
	SHAR.L #2,ERd	L	2													1	
	SHLL.B Rd	B	2													1	
	SHLL.B #2,Rd	B	2													1	
	SHLL.W Rd	W	2													1	
SHLR	SHLL.W #2,Rd	W	2													1	
	SHLL.L ERd	L	2													1	
	SHLL.L #2,ERd	L	2													1	
	SHLR.B Rd	B	2													1	
	SHLR.B #2,Rd	B	2													1	
ROTXL	SHLR.W Rd	W	2													1	
	SHLR.W #2,Rd	W	2													1	
	SHLR.L ERd	L	2													1	
	SHLR.L #2,ERd	L	2													1	
	ROTXL.B Rd	B	2													1	
ROTXL	ROTXL.B #2,Rd	B	2													1	
	ROTXL.W Rd	W	2													1	
	ROTXL.W #2,Rd	W	2													1	
	ROTXL.L ERd	L	2													1	
	ROTXL.L #2,ERd	L	2													1	

Mnemonic	Size	Addressing Mode and Instruction Length (Bytes)							Operation	Condition Code						No. of States*1	
		#xx	Rn	@ERn	@(d,ERn)	@-ERn/@ERn+	@aa	@(d,PC)		@@aa	I	H	N	Z	V	C	Normal
ROTXR	B	2														1	1
	B	2														1	1
	W	2														1	1
	W	2														1	1
	L	2														1	1
	L	2														1	1
ROTL	B	2														1	1
	B	2														1	1
	W	2														1	1
	W	2														1	1
	L	2														1	1
	L	2														1	1
ROTR	B	2														1	1
	B	2														1	1
	W	2														1	1
	W	2														1	1
	L	2														1	1
	L	2														1	1

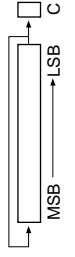
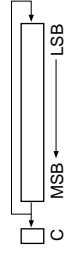
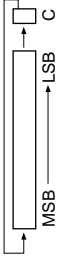

(5) Bit Manipulation Instructions

Mnemonic	Size	Addressing Mode and Instruction Length (Bytes)						Operation	Condition Code						No. of States <sup>*1</sup>			
		#xx	Rn	@ERn	@ (d,ERn)	@-ERn/ERn+	@ (d,PC)		@aa	I	I	H	N	Z	V	C	Normal	Advanced
																	2	4
BSET	BSET #xx:3,Rd	B	2															1
	BSET #xx:3,@ERd	B		4														4
	BSET #xx:3,@aa:8	B					4											4
	BSET #xx:3,@aa:16	B					6											5
	BSET #xx:3,@aa:32	B					8											6
	BSET Rn,Rd	B	2															1
	BSET Rn,@ERd	B		4														4
	BSET Rn,@aa:8	B					4											4
	BSET Rn,@aa:16	B					6											5
	BSET Rn,@aa:32	B					8											6
BCLR	BCLR #xx:3,Rd	B	2															1
	BCLR #xx:3,@ERd	B		4														4
	BCLR #xx:3,@aa:8	B					4											4
	BCLR #xx:3,@aa:16	B					6											5
	BCLR #xx:3,@aa:32	B					8											6
	BCLR Rn,Rd	B	2															1
	BCLR Rn,@ERd	B		4														4
	BCLR Rn,@aa:8	B					4											4
	BCLR Rn,@aa:16	B					6											5
	BCLR Rn,@aa:32	B					8											6
BNOT	BNOT #xx:3,Rd	B	2															1
	BNOT #xx:3,@ERd	B		4														4
	BNOT #xx:3,@aa:8	B					4											4
	BNOT #xx:3,@aa:16	B					6											5
	BNOT #xx:3,@aa:32	B					8											6
	BNOT Rn,Rd	B	2															1
	BNOT Rn,@ERd	B		4														4
	BNOT Rn,@aa:8	B					4											4
	BNOT Rn,@aa:16	B					6											5
	BNOT Rn,@aa:32	B					8											6









Mnemonic	Size	Addressing Mode and Instruction Length (Bytes)								Operation	Condition Code						No. of States*1		
		#xx	Rn	@ERn	@dERn	@-ERn/ERn+	@aa	@d,PC	@@aa		I	I	H	N	Z	V	C	Normal	Advanced
JMP	JMP @ERn	—																2	
	JMP @aa:24	—		2			4											3	
	JMP @:aa:8	—							2									4	5
BSR	BSR d:8	—						2										3	4
	BSR d:16	—						4										4	5
JSR	JSR @ERn	—																3	4
	JSR @aa:24	—		2			4											4	5
	JSR @:aa:8	—							2									4	6
RTS	RTS	—											2					4	5



Mnemonic	Size	Addressing Mode and Instruction Length (Bytes)								Operation	Condition Code						No. of States <sup>1)</sup>			
		#xx	Rn	@ERn	@ (d,ERn)	@-ERn/@ERn+	@aa	@ (d,PC)	@aa		I	I	H	N	Z	V	C	Normal	Advanced	
STC	STC CCR,Rd	B	2															CCR→Rd8	1	
	STC EXR,Rd	B	2															EXR→Rd8	1	
	STC CCR,@ERd	W		4														CCR→@ERd	3	
	STC EXR,@ERd	W		4														EXR→@ERd	3	
	STC CCR,@ (d;16,ERd)	W			6													CCR→@ (d;16,ERd)	4	
	STC EXR,@ (d;16,ERd)	W			6													EXR→@ (d;16,ERd)	4	
	STC CCR,@ (d;32,ERd)	W			10													CCR→@ (d;32,ERd)	6	
	STC EXR,@ (d;32,ERd)	W			10													EXR→@ (d;32,ERd)	6	
	STC CCR,@-ERd	W				4												ERd32-2→ERd32,CCR→@ERd	4	
	STC EXR,@-ERd	W				4												ERd32-2→ERd32,EXR→@ERd	4	
ANDC	STC CCR,@aa:16	W								6								CCR→@aa:16	4	
	STC EXR,@aa:16	W								6								EXR→@aa:16	4	
	STC CCR,@aa:32	W								8								CCR→@aa:32	5	
	STC EXR,@aa:32	W								8								EXR→@aa:32	5	
ORC	ANDC #xx:8,CCR	B	2															CCR, #xx:8→CCR	1	
	ANDC #xx:8,EXR	B	4															EXR, #xx:8→EXR	2	
XORC	ORC #xx:8,CCR	B	4															CCR, #xx:8→CCR	1	
	ORC #xx:8,EXR	B	4															EXR, #xx:8→EXR	2	
NOP	XORC #xx:8,CCR	B	2															CCR@#xx:8→CCR	1	
	XORC #xx:8,EXR	B	4															EXR@#xx:8→EXR	2	
NOP	NOP	—																PC→PC+2	1	

## (8) Block Transfer Instructions

Mnemonic	Size	Addressing Mode and Instruction Length (Bytes)						Operation	Condition Code					No. of States*1			
		#xx	Rn	@ERn	@(d,ERn)	@-ERn/@ERn+	@aa		@(d,PC)	@aa	I	H	N	Z	V	C	Normal
EEMOV/B	—							4	if R4L ≠ 0 Repeat @ER5+→@ER6+ ER5+1→ER5 ER6+1→ER6 R4L-1→R4L Until R4L=0 else next;	—	—	—	—	—	—	4+2n*2	
EEMOV/W	—							4	if R4 ≠ 0 Repeat @ER5+→@ER6+ ER5+1→ER5 ER6+1→ER6 R4-1→4 Until R4=0 else next;	—	—	—	—	—	—	4+2n*2	

Notes: 1. The number of states is the number of states required for execution when the instruction and its operands are located in on-chip memory.

2. n is the initial setting of R4L or R4.

3. Seven states for saving or restoring two registers, nine states for three registers, or eleven states for four registers.

4. One additional state is required for execution immediately after a MULXU, MULXS, or STMAC instruction. Also, a maximum of three additional states are required for execution of a MULXU instruction within three states after execution of a MAC instruction. For example, if there is a one-state instruction (such as NOP) between a MAC instruction and a MULXU instruction, the MULXU instruction will be two states longer.

5. A maximum of two additional states are required for execution of a MULXS instruction within two states after execution of a MAC instruction.

For example, if there is a one-state instruction (such as NOP) between a MAC instruction and a MULXS instruction, the MULXS instruction will be one state longer.

6. A maximum of three additional states are required for execution of one of these instructions within three states after execution of a MAC instruction.

For example, if there is a one-state instruction (such as NOP) between a MAC instruction and one of these instructions, that instruction will be two states longer.

7. For the H8S/2000 CPU.

8. Only register ER0, ER1, ER4, or ER5 should be used when using the TAS instruction.

9. These instructions are supported only by the H8S/2600 CPU.

(1) The number of states required for execution of an instruction that transfers data in synchronization with the E clock is variable.

(2) Set to 1 when a carry or borrow occurs at bit 11; otherwise cleared to 0.

(3) Set to 1 when a carry or borrow occurs at bit 27; otherwise cleared to 0.

(4) Retains its previous value when the result is zero; otherwise cleared to 0.

(5) Set to 1 when the divisor is negative; otherwise cleared to 0.

(6) Set to 1 when the divisor is zero; otherwise cleared to 0.

(7) Set to 1 when the quotient is negative; otherwise cleared to 0.

(8) MAC instruction results are indicated in the flags when the STMAC instruction is executed.

(9) One additional state is required for execution when EXR is valid.

## 2.4 Instruction Code

Table 2.2 Instruction Codes

Instruction	Mnemonic	Size	Instruction Format																	
			1st byte	2nd byte	3rd byte	4th byte	5th byte	6th byte	7th byte	8th byte	9th byte	10th byte								
ADD	ADD.B #xx:8,Rd	B	8	rd	IMM															
	ADD.B Rs,Rd	B	0	8	rs	rd														
	ADD.W #xx:16,Rd	W	7	9	1	rd														
	ADD.W Rs,Rd	W	0	9	rs	rd														
	ADD.L #xx:32,ERd	L	7	A	1	0:erd														
	ADD.L ERs,ERd	L	0	A	1	ers:0:erd														
	ADD.S #1,ERd	L	0	B	0	0:erd														
ADDS	ADDS #2,ERd	L	0	B	8	0:erd														
	ADDS #4,ERd	L	0	B	9	0:erd														
ADDX	ADDX #xx:8,Rd	B	9	rd	IMM															
	ADDX Rs,Rd	B	0	E	rs	rd														
AND	AND.B #xx:8,Rd	B	E		IMM															
	AND.B Rs,Rd	B	1	6	rs	rd														
AND.W	AND.W #xx:16,Rd	W	7	9	6	rd														
	AND.W Rs,Rd	W	6	6	rs	rd														
AND.L	AND.L #xx:32,ERd	L	7	A	6	0:erd														
	AND.L ERs,ERd	L	0	1	F	0	6:6:ers:0:erd													
ANDC	ANDC #xx:8,CCR	B	0	6	IMM															
	ANDC #xx:8,EXR	B	0	1	4	1	0:6	IMM												
BAND	BAND #xx:3,Rd	B	7	6	0:IMM:	rd														
	BAND #xx:3,@ERd	B	7	C	0:erd:	0	7:6	0:IMM:	0											
	BAND #xx:3,@aa:8	B	7	E	abs	abs	7:6	0:IMM:	0											
	BAND #xx:3,@aa:16	B	6	A	1	0	abs	abs	7:6	0:IMM:	0									
	BAND #xx:3,@aa:32	B	6	A	3	0	abs	abs	7:6	0:IMM:	0									
Bcc	BRA d:8 (BT d:8)	—	4	0	disp															
	BRA d:16 (BT d:16)	—	5	8	0	0	disp													
	BRN d:8 (BF d:8)	—	4	1	disp															
	BRN d:16 (BF d:16)	—	5	8	1	0	disp													
	BHI d:8	—	4	2	disp															
	BHI d:16	—	5	8	2	0	disp													
	BLS d:8	—	4	3	disp															
	BLS d:16	—	5	8	3	0	disp													
BCC d:8 (BHS d:8)	—	4	4	disp																

Instruction	Mnemonic	Size	Instruction Format																	
			1st byte	2nd byte	3rd byte	4th byte	5th byte	6th byte	7th byte	8th byte	9th byte	10th byte								
Bcc	BCC d:16 (BHS d:16)	—	5	8	4	0	disp													
	BCS d:8 (BLO d:8)	—	4	5	disp															
	BCS d:16 (BLO d:16)	—	5	8	5	0	disp													
	BNE d:8	—	4	6	disp															
	BNE d:16	—	5	8	6	0	disp													
	BEQ d:8	—	4	7	disp															
	BEQ d:16	—	5	8	7	0	disp													
	BVC d:8	—	4	8	disp															
	BVC d:16	—	5	8	8	0	disp													
	BVS d:8	—	4	9	disp															
	BVS d:16	—	5	8	9	0	disp													
	BPL d:8	—	4	A	disp															
	BPL d:16	—	5	8	A	0	disp													
	BMI d:8	—	4	B	disp															
	BMI d:16	—	5	8	B	0	disp													
	BGE d:8	—	4	C	disp															
	BGE d:16	—	5	8	C	0	disp													
	BLT d:8	—	4	D	disp															
	BLT d:16	—	5	8	D	0	disp													
BGT d:8	—	4	E	disp																
BGT d:16	—	5	8	E	0	disp														
BLE d:8	—	4	F	disp																
BLE d:16	—	5	8	F	0	disp														
BCLR	BCLR #xx:3;Rd	B	7	2	0:IMM;	rd														
	BCLR #xx:3:@ERd	B	7	D	0:erd;	0	7	2	0:IMM;	0										
	BCLR #xx:3 @aa:8	B	7	F	abs	7	2	0:IMM;	0											
	BCLR #xx:3 @aa:16	B	6	A	1	8	abs	7	2	0:IMM;	0									
	BCLR #xx:3 @aa:32	B	6	A	3	8	abs	7	2	0:IMM;	0									
	BCLR Rn;Rd	B	6	2	rd	rd														
	BCLR Rn @ERd	B	7	D	0:erd;	0	6	2	rd	0										
	BCLR Rn @aa:8	B	7	F	abs	6	2	rd	0											
	BCLR Rn @aa:16	B	6	A	1	8	abs	6	2	rd	0									
	BCLR Rn @aa:32	B	6	A	3	8	abs	6	2	rd	0									

Instruction	Mnemonic	Size	Instruction Format																	
			1st byte	2nd byte	3rd byte	4th byte	5th byte	6th byte	7th byte	8th byte	9th byte	10th byte								
BIAND	BIAND #xx:3,Rd	B	7	6	1:IMM; rd															
	BIAND #xx:3,@ERd	B	7	C	0:erd; 0	7	6	1:IMM; 0												
	BIAND #xx:3,@aa8	B	7	E	abs	7	6	1:IMM; 0												
	BIAND #xx:3,@aa:16	B	6	A	1	0	abs	7	6	1:IMM; 0										
	BIAND #xx:3,@aa:32	B	6	A	3	0	abs	7	6	1:IMM; 0										
BILD	BILD #xx:3,Rd	B	7	7	1:IMM; rd															
	BILD #xx:3,@ERd	B	7	C	0:erd; 0	7	7	1:IMM; 0												
	BILD #xx:3,@aa8	B	7	E	abs	7	7	1:IMM; 0												
	BILD #xx:3,@aa:16	B	6	A	1	0	abs	7	7	1:IMM; 0										
	BILD #xx:3,@aa:32	B	6	A	3	0	abs	7	7	1:IMM; 0										
BIOR	BIOR #xx:3,Rd	B	7	4	1:IMM; rd															
	BIOR #xx:3,@ERd	B	7	C	0:erd; 0	7	4	1:IMM; 0												
	BIOR #xx:3,@aa8	B	7	E	abs	7	4	1:IMM; 0												
	BIOR #xx:3,@aa:16	B	6	A	1	0	abs	7	4	1:IMM; 0										
	BIOR #xx:3,@aa:32	B	6	A	3	0	abs	7	4	1:IMM; 0										
BIST	BIST #xx:3,Rd	B	6	7	1:IMM; rd															
	BIST #xx:3,@ERd	B	7	D	0:erd; 0	6	7	1:IMM; 0												
	BIST #xx:3,@aa8	B	7	F	abs	6	7	1:IMM; 0												
	BIST #xx:3,@aa:16	B	6	A	1	8	abs	6	7	1:IMM; 0										
	BIST #xx:3,@aa:32	B	6	A	3	8	abs	6	7	1:IMM; 0										
BIXOR	BIXOR #xx:3,Rd	B	7	5	1:IMM; rd															
	BIXOR #xx:3,@ERd	B	7	C	0:erd; 0	7	5	1:IMM; 0												
	BIXOR #xx:3,@aa8	B	7	E	abs	7	5	1:IMM; 0												
	BIXOR #xx:3,@aa:16	B	6	A	1	0	abs	7	5	1:IMM; 0										
	BIXOR #xx:3,@aa:32	B	6	A	3	0	abs	7	5	1:IMM; 0										
BLD	BLD #xx:3,Rd	B	7	7	0:IMM; rd															
	BLD #xx:3,@ERd	B	7	C	0:erd; 0	7	7	0:IMM; 0												
	BLD #xx:3,@aa8	B	7	E	abs	7	7	0:IMM; 0												
	BLD #xx:3,@aa:16	B	6	A	1	0	abs	7	7	0:IMM; 0										
	BLD #xx:3,@aa:32	B	6	A	3	0	abs	7	7	0:IMM; 0										
BNOT	BNOT #xx:3,Rd	B	7	1	0:IMM; rd															
	BNOT #xx:3,@ERd	B	7	D	0:erd; 0	7	1	0:IMM; 0												
	BNOT #xx:3,@aa8	B	7	F	abs	7	1	0:IMM; 0												
	BNOT #xx:3,@aa:16	B	6	A	1	8	abs	7	1	0:IMM; 0										
	BNOT #xx:3,@aa:32	B	6	A	3	8	abs	7	1	0:IMM; 0										
BNOT Rn,Rd	B	6	1	rn rd																

Instruction	Mnemonic	Size	Instruction Format																	
			1st byte	2nd byte	3rd byte	4th byte	5th byte	6th byte	7th byte	8th byte	9th byte	10th byte								
BNOT	BNOT Rn, @ERd	B	7	D	0; erd	0	6	1	rn	0										
	BNOT Rn, @aa:8	B	7	F	abs		6	1	rn	0										
	BNOT Rn, @aa:16	B	6	A	1	8	abs		6	1	rn	0								
	BNOT Rn, @aa:32	B	6	A	3	8	abs													
BOR	BOR #xx:3, Rd	B	7	4	0; IMM	rd														
	BOR #xx:3, @ERd	B	7	C	0; erd	0	7	4	0; IMM	0										
	BOR #xx:3, @aa:8	B	7	E	abs		7	4	0; IMM	0										
	BOR #xx:3, @aa:16	B	6	A	1	0	abs		7	4	0; IMM	0								
	BOR #xx:3, @aa:32	B	6	A	3	0	abs													
	BSET #xx:3, Rd	B	7	0	0; IMM	rd														
BSET	BSET #xx:3, @ERd	B	7	D	0; erd	0	7	0	0; IMM	0										
	BSET #xx:3, @aa:8	B	7	F	abs		7	0	0; IMM	0										
	BSET #xx:3, @aa:16	B	6	A	1	8	abs		7	0	0; IMM	0								
	BSET #xx:3, @aa:32	B	6	A	3	8	abs													
	BSET Rn, Rd	B	6	0	rn	rd														
	BSET Rn, @ERd	B	7	D	0; erd	0	6	0	rn	0										
	BSET Rn, @aa:8	B	7	F	abs		6	0	rn	0										
	BSET Rn, @aa:16	B	6	A	1	8	abs		6	0	rn	0								
	BSET Rn, @aa:32	B	6	A	3	8	abs													
	BSR d:8	—	5	5	disp															
BST	BSR d:16	—	5	C	0	0	disp													
	BST #xx:3, Rd	B	6	7	0; IMM	rd														
	BST #xx:3, @ERd	B	7	D	0; erd	0	6	7	0; IMM	0										
	BST #xx:3, @aa:8	B	7	F	abs		6	7	0; IMM	0										
	BST #xx:3, @aa:16	B	6	A	1	8	abs		6	7	0; IMM	0								
	BST #xx:3, @aa:32	B	6	A	3	8	abs													
BTST	BTST #xx:3, Rd	B	7	3	0; IMM	rd														
	BTST #xx:3, @ERd	B	7	C	0; erd	0	7	3	0; IMM	0										
	BTST #xx:3, @aa:8	B	7	E	abs		7	3	0; IMM	0										
	BTST #xx:3, @aa:16	B	6	A	1	0	abs		7	3	0; IMM	0								
	BTST #xx:3, @aa:32	B	6	A	3	0	abs													
	BTST Rn, Rd	B	6	3	rn	rd														
BTST Rn, @aa:8	BTST Rn, @ERd	B	7	C	0; erd	0	6	3	rn	0										
	BTST Rn, @aa:8	B	7	E	abs		6	3	rn	0										
	BTST Rn, @aa:16	B	6	A	1	0	abs		6	3	rn	0								
	BTST Rn, @aa:32	B	6	A	3	0	abs													
	BTST Rn, @aa:8	B	6	A	1	0	abs		6	3	rn	0								
	BTST Rn, @aa:32	B	6	A	3	0	abs													



Instruction	Mnemonic	Size	Instruction Format																	
			1st byte	2nd byte	3rd byte	4th byte	5th byte	6th byte	7th byte	8th byte	9th byte	10th byte								
BXOR	BXOR #xx:3,Rd	B	7	5	0:IMM: rd															
	BXOR #xx:3,@ERd	B	7	C	0:erd	0	7	5	0:IMM: 0											
	BXOR #xx:3,@aa:8	B	7	E	abs		7	5	0:IMM: 0											
	BXOR #xx:3,@aa:16	B	6	A	1	0			abs	7	5	0:IMM: 0								
CLRMAC*1	BXOR #xx:3,@aa:32	B	6	A	3	0			abs	7	5	0:IMM: 0			7	5	0:IMM: 0			
	CLRMAC	—	0	1	A	0														
CMP	CMPB #x:8,Rd	B	A	rd	IMM															
	CMPB Rs,Rd	B	1	C	rs	rd														
	CMPW #xx:16,Rd	W	7	9	2	rd			IMM											
	CMPW Rd,Rd	W	1	D	rs	rd														
	CMPL #xx:32,ERd	L	7	A	2	0:erd				IMM										
	CMPL ERs,ERd	L	1	F	1:ers	0:erd														
DAA	DAA Rd	B	0	F	0	rd														
	DAS Rd	B	1	F	0	rd														
DEC	DECB Rd	B	1	A	0	rd														
	DECW #1,Rd	W	1	B	5	rd														
	DECW #2,Rd	W	1	B	D	rd														
	DECL #1,ERd	L	1	B	7	0:erd														
DIVXS	DECL #2,ERd	L	1	B	F	0:erd														
	DIVXS B Rs,Rd	B	0	1	D	0	5	1	rs	rd										
	DIVXS W Rs,ERd	W	0	1	D	0	5	3	rs	0:erd										
	DIVXUB Rs,Rd	B	5	1	rs	rd														
	DIVXUW Rs,ERd	W	5	3	rs	0:erd														
	EEPMOVB	—	7	B	5	C	5	9	8	F										
	EEPMOVW	—	7	B	D	4	5	9	8	F										
	EXTS W Rd	W	1	7	D	rd														
	EXTS L ERd	L	1	7	F	0:erd														
	EXTU	EXTU W Rd	W	1	7	5	rd													
EXTU L ERd		L	1	7	7	0:erd														
INC B Rd		B	0	A	0	rd														
INC	INC W #1,Rd	W	0	B	5	rd														
	INC W #2,Rd	W	0	B	D	rd														
	INC L #1,ERd	L	0	B	7	0:erd														
	INC L #2,ERd	L	0	B	F	0:erd														

Instruction	Mnemonic	Size	Instruction Format																	
			1st byte	2nd byte	3rd byte	4th byte	5th byte	6th byte	7th byte	8th byte	9th byte	10th byte								
JMP	JMP @ERn	—	5	9	0:erm	0														
	JMP @aa:24	—	5	A		abs														
	JMP @aa:8	—	5	B		abs														
JSR	JSR @ERn	—	5	D	0:erm	0														
	JSR @aa:24	—	5	E		abs														
	JSR @aa:8	—	5	F		abs														
LDC	LDC #xx:8,CCR	B	0	7	IMM															
	LDC #xx:8,EXR	B	0	1	4	1	0	7	IMM											
	LDC Rs,CCR	B	0	3	0	rs														
	LDC Rs,EXR	B	0	3	1	rs														
	LDC @ERs,CCR	W	0	1	4	0	6	9	0:ers	0										
	LDC @ERs,EXR	W	0	1	4	1	6	9	0:ers	0										
	LDC @(d:16,ERs),CCR	W	0	1	4	0	6	F	0:ers	0		disp								
	LDC @(d:16,ERs),EXR	W	0	1	4	1	6	F	0:ers	0		disp								
	LDC @(d:32,ERs),CCR	W	0	1	4	0	7	8	0:ers	0	6	B	2	0						disp
	LDC @(d:32,ERs),EXR	W	0	1	4	1	7	8	0:ers	0	6	B	2	0						disp
LDM	LDC @ERs+,CCR	W	0	1	4	0	6	D	0:ers	0										
	LDC @ERs+,EXR	W	0	1	4	1	6	D	0:ers	0										
	LDC @aa:16,CCR	W	0	1	4	0	6	B	0	0			abs							
	LDC @aa:16,EXR	W	0	1	4	1	6	B	0	0			abs							
	LDC @aa:32,CCR	W	0	1	4	0	6	B	2	0										
	LDC @aa:32,EXR	W	0	1	4	1	6	B	2	0										
	LDM.L @SP+,(ERn-ERn+1)	L	0	1	1	0	6	D	7	0:erm+1										
	LDM.L @SP+,(ERn-ERn+2)	L	0	1	2	0	6	D	7	0:erm+2										
	LDM.L @SP+,(ERn-ERn+3)	L	0	1	3	0	6	D	7	0:erm+3										
	LDMAC #1	LDMAC ERS,WACH	L	0	3	2	0:ers													
MAC #1	LDMAC ERS,MACL	L	0	3	3	0:ers														
	MAC @ERn+,@ERm+	—	0	1	6	0	D	0:erm	0:erm											
MOV	MOV.B #xx:8,Rd	B	F	rd	IMM															
	MOV.B Rs,Rd	B	0	C	rs	rd														
	MOV.B @ERs,Rd	B	6	8	0:ers	rd														
	MOV.B @(d:16,ERs),Rd	B	6	E	0:ers	rd				disp										
	MOV.B @(d:32,ERs),Rd	B	7	8	0:ers	0	6	A	2	rd										
	MOV.B @ERs+,Rd	B	6	C	0:ers	rd														
	MOV.B @aa:8,Rd	B	2	rd		abs														
MOV.B @aa:16,Rd	B	6	A	0	rd				abs											

Instruction	Mnemonic	Size	Instruction Format																	
			1st byte	2nd byte	3rd byte	4th byte	5th byte	6th byte	7th byte	8th byte	9th byte	10th byte								
MOV	MOV.B @aa:32,Rd	B	6	A	2	rd				abs										
	MOV.B Rs,@ERd	B	6	8	1:erd	rs														
	MOV.B Rs,@(d:16,ERd)	B	6	E	1:erd	rs			disp											
	MOV.B Rs,@(d:32,ERd)	B	7	8	0:erd	0	6	A	A	rs				disp						
	MOV.B Rs,@-ERd	B	6	C	1:erd	rs														
	MOV.B Rs,@aa:8	B	3	rs		abs														
	MOV.B Rs,@aa:16	B	6	A	8	rs			abs											
	MOV.B Rs,@aa:32	B	6	A	A	A			abs											
	MOV.W #xx:16,Rd	W	7	9	0	rd			IMM											
	MOV.W Rs,Rd	W	0	D	rs	rd														
	MOV.W @ERs,Rd	W	6	9	0:ers	rd														
	MOV.W @(d:16,ERs),Rd	W	6	F	0:ers	rd			disp											
	MOV.W @(d:32,ERs),Rd	W	7	8	0:ers	0	6	B	2	rd				disp						
	MOV.W @ERs+,Rd	W	6	D	0:ers	rd														
	MOV.W @aa:16,Rd	W	6	B	0	rd			abs											
	MOV.W @aa:32,Rd	W	6	B	2	rd			abs											
	MOV.W Rs,@ERd	W	6	9	1:erd	rs														
	MOV.W Rs,@(d:16,ERd)	W	6	F	1:erd	rs			disp											
	MOV.W Rs,@(d:32,ERd)	W	7	8	0:erd	0	6	B	A	rs				disp						
	MOV.W Rs,@-ERd	W	6	D	1:erd	rs														
MOV.W Rs,@aa:16	W	6	B	8	rs			abs												
MOV.W Rs,@aa:32	W	6	B	A	rs			abs												
MOV.L #xx:32,Rd	L	7	A	0	0:erd			IMM												
MOV.L ERs,ERd	L	0	F	1:ers	0:erd															
MOV.L @ERs,ERd	L	0	1	0	0	6	9	0:ers	0:erd											
MOV.L @(d:16,ERs),ERd	L	0	1	0	0	6	F	0:ers	0:erd	disp										
MOV.L @(d:32,ERs),ERd	L	0	1	0	0	7	8	0:ers	0											
MOV.L @ERs+,ERd	L	0	1	0	0	6	D	0:ers	0:erd											
MOV.L @aa:16,ERd	L	0	1	0	0	6	B	0	0:erd											
MOV.L @aa:32,ERd	L	0	1	0	0	6	B	2	0:erd											
MOV.L ERs,@ERd	L	0	1	0	0	6	9	1:erd	0:ers											
MOV.L ERs,@(d:16,ERd)	L	0	1	0	0	6	F	1:erd	0:ers	disp										
MOV.L ERs,@(d:32,ERd) <sup>92</sup>	L	0	1	0	0	7	8	0:erd	0											
MOV.L ERs,@-ERd	L	0	1	0	0	6	D	1:erd	0:ers											
MOV.L ERs,@aa:16	L	0	1	0	0	6	B	8	0:ers											
MOV.L ERs,@aa:32	L	0	1	0	0	6	B	A	0:ers											

Instruction	Mnemonic	Size	Instruction Format																	
			1st byte	2nd byte	3rd byte	4th byte	5th byte	6th byte	7th byte	8th byte	9th byte	10th byte								
MOVFP	MOVFP @aa:16,Rd	B	6	A	4	rd														
MOVTP	MOVTP Rs,@aa:16	B	6	A	C	rs	abs													
MULS	MULS.B Rs,Rd	B	0	1	C	0	5	0	rs	rd										
	MULS.W Rs,ERd	W	0	1	C	0	5	2	rs	:0:;erd										
MULX	MULX.B Rs,Rd	B	5	0	rs	rd														
	MULX.W Rs,ERd	W	5	2	rs	:0:;erd														
NEG	NEGB Rd	B	1	7	8	rd														
	NEG.W Rd	W	1	7	9	rd														
	NEGL ERd	L	1	7	B	:0:;erd														
NOP	NOP	—	0	0	0	0														
NOT	NOTB Rd	B	1	7	0	rd														
	NOT.W Rd	W	1	7	1	rd														
	NOTL ERd	L	1	7	3	:0:;erd														
OR	OR.B #xx:8,Rd	B	C	rd	IMM															
	OR.B Rs,Rd	B	1	4	rs	rd														
	OR.W #xx:16,Rd	W	7	9	4	rd	IMM													
	OR.W Rs,Rd	W	6	4	rs	rd														
	OR.L #xx:32,ERd	L	7	A	4	:0:;erd	IMM													
	OR.L ERs,ERd	L	0	1	F	0	6	4	0:;ers	:0:;erd										
ORC	ORC #xx:8,CCR	B	0	4	IMM															
	ORC #xx:8,EXR	B	0	1	4	1	0	4	IMM											
POP	POP.W Rn	W	6	D	7	rn														
	POP.L ERn	L	0	1	0	0	6	D	7	:0:;ern										
PUSH	PUSH.W Rn	W	6	D	F	rn														
	PUSH.L ERn	L	0	1	0	0	6	D	F	:0:;ern										
ROTL	ROTLB Rd	B	1	2	8	rd														
	ROTL.B #2,Rd	B	1	2	C	rd														
	ROTL.W Rd	W	1	2	9	rd														
	ROTL.W #2,Rd	W	1	2	D	rd														
	ROTL.L ERd	L	1	2	B	:0:;erd														
	ROTL.L #2,ERd	L	1	2	F	:0:;erd														
ROTR	ROTRB Rd	B	1	3	8	rd														
	ROTR.B #2,Rd	B	1	3	C	rd														
	ROTR.W Rd	W	1	3	9	rd														
	ROTR.W #2,Rd	W	1	3	D	rd														

Instruction	Mnemonic	Size	Instruction Format																	
			1st byte	2nd byte	3rd byte	4th byte	5th byte	6th byte	7th byte	8th byte	9th byte	10th byte								
ROTR	ROTR.L ERd	L	1	3	B	0	: end													
	ROTR.L #2,ERd	L	1	3	F	0	: end													
ROTXL	ROTXL.B Rd	B	1	2	0	rd														
	ROTXL.B #2,Rd	B	1	2	4	rd														
	ROTXL.W Rd	W	1	2	1	rd														
	ROTXL.W #2,Rd	W	1	2	5	rd														
	ROTXL.L ERd	L	1	2	3	0	: end													
	ROTXL.L #2,ERd	L	1	2	7	0	: end													
ROTXR	ROTXR.B Rd	B	1	3	0	rd														
	ROTXR.B #2,Rd	B	1	3	4	rd														
	ROTXR.W Rd	W	1	3	1	rd														
	ROTXR.W #2,Rd	W	1	3	5	rd														
	ROTXR.L ERd	L	1	3	3	0	: end													
	ROTXR.L #2,ERd	L	1	3	7	0	: end													
RTE	RTE	—	5	6	7	0														
RTS	RTS	—	5	4	7	0														
SHAL	SHAL.B Rd	B	1	0	8	rd														
	SHAL.B #2,Rd	B	1	0	C	rd														
	SHAL.W Rd	W	1	0	9	rd														
	SHAL.W #2,Rd	W	1	0	D	rd														
	SHALL ERd	L	1	0	B	0	: end													
	SHALL #2,ERd	L	1	0	F	0	: end													
SHAR	SHAR.B Rd	B	1	1	8	rd														
	SHAR.B #2,Rd	B	1	1	C	rd														
	SHAR.W Rd	W	1	1	9	rd														
	SHAR.W #2,Rd	W	1	1	D	rd														
	SHAR.L ERd	L	1	1	B	0	: end													
	SHAR.L #2,ERd	L	1	1	F	0	: end													
SHLL	SHLL.B Rd	B	1	0	0	rd														
	SHLL.B #2,Rd	B	1	0	4	rd														
	SHLL.W Rd	W	1	0	1	rd														
	SHLL.W #2,Rd	W	1	0	5	rd														
	SHLL.L ERd	L	1	0	3	0	: end													
	SHLL.L #2,ERd	L	1	0	7	0	: end													
SHLR	SHLR.B Rd	B	1	1	0	rd														
	SHLR.B #2,Rd	B	1	1	4	rd														

Instruction	Mnemonic	Size	Instruction Format																		
			1st byte	2nd byte	3rd byte	4th byte	5th byte	6th byte	7th byte	8th byte	9th byte	10th byte									
SHLR	SHLR,W,Rd	W	1	1	rd																
	SHLR,W,#2,Rd	W	1	5	rd																
	SHLR,L,ERd	L	1	3	0:erd																
	SHLR,L,#2,ERd	L	1	7	0:erd																
SLEEP	SLEEP	—	0	1	8	0															
	STC	B	0	2	0	rd															
STC	STC,B,CCR,Rd	B	0	2	1	rd															
	STC,B,EXR,Rd	B	0	2	1	rd															
	STC,W,CCR,@,ERd	W	0	1	4	0	6	9	1:erd	0											
	STC,W,EXR,@,ERd	W	0	1	4	1	6	9	1:erd	0											
	STC,W,CCR,@,(d:16,ERd)	W	0	1	4	0	6	F	1:erd	0	disp										
	STC,W,EXR,@,(d:16,ERd)	W	0	1	4	1	6	F	1:erd	0	disp										
	STC,W,CCR,@,(d:32,ERd)	W	0	1	4	0	7	8	0:erd	0	6	B	A	0						disp	
	STC,W,EXR,@,(d:32,ERd)	W	0	1	4	1	7	8	0:erd	0	6	B	A	0							disp
	STC,W,CCR,@,ERd	W	0	1	4	0	6	D	1:erd	0											
	STC,W,EXR,@,ERd	W	0	1	4	1	6	D	1:erd	0											
	STC,W,CCR,@,aa:16	W	0	1	4	0	6	B	8	0	abs										
	STC,W,EXR,@,aa:16	W	0	1	4	1	6	B	8	0	abs										
STM	STC,W,CCR,@,aa:32	W	0	1	4	0	6	B	A	0	abs										
	STC,W,EXR,@,aa:32	W	0	1	4	1	6	B	A	0	abs										
	STM,L,(ERn-ERn+1),@,SP	L	0	1	1	0	6	D	F	0:ern											
	STM,L,(ERn-ERn+2),@,SP	L	0	1	2	0	6	D	F	0:ern											
	STM,L,(ERn-ERn+3),@,SP	L	0	1	3	0	6	D	F	0:ern											
	STM,MAC,MACL,ERd	L	0	2	2	0:ers															
SUB	STM,MAC,MACL,ERd	L	0	2	3	0:ers															
	STM,MAC,MACL,ERd	L	0	2	3	0:ers															
	SUB,B,Rs,Rd	B	1	8	rs	rd															
	SUB,W,#x:16,Rd	W	7	9	3	rd				IMM											
	SUB,W,Rs,Rd	W	1	9	rs	rd															
SUBS	SUB,L,#x:32,ERd	L	7	A	3	0:erd															
	SUB,L,ERs,ERd	L	1	A	1:ers	0:erd															
	SUBS,#1,ERd	L	1	B	0	0:erd															
	SUBS,#2,ERd	L	1	B	8	0:erd															
SUBX	SUBS,#4,ERd	L	1	B	9	0:erd															
	SUBX,#x:8,Rd	B	B	rd	IMM																
	SUBX,Rs,Rd	B	1	E	rs	rd															
TAS	TAS,@,ERd <sup>3</sup>	B	0	1	E	0	7	B	0:erd	C											
TRAPA	TRAPA,#x:2	—	5	7	00:IMM	0															

Instruction	Mnemonic	Size	Instruction Format															
			1st byte	2nd byte	3rd byte	4th byte	5th byte	6th byte	7th byte	8th byte	9th byte	10th byte						
XOR	XOR.B #xx:8,Rd	B	D	rd														
	XOR.B Rs,Rd	B	1	5	rs	rd												
	XOR.W #xx:16,Rd	W	7	9	5	rd												
	XOR.W Rs,Rd	W	6	5	rs	rd												
	XOR.L #xx:32,ERd	L	7	A	5	0; erd												
XORC	XOR.L ERs,ERd	L	0	1	F	0	6	5	0; ers; 0; erd									
	XORC #xx:8,CCR	B	0	5	IMM													
	XORC #xx:8,EXR	B	0	1	4	1	0	5	IMM									

- Notes: 1. These instructions are supported by the H8S/2600 CPU only.  
2. Bit 7 of the 4th byte of the MOV.L ERs, @(d:32:ERd) instruction can be either 1 or 0.  
3. Only register ER0, ER1, ER4, or ER5 should be used when using the TAS instruction.

### Legend

IMM: Immediate data (2, 3, 8, 16, or 32 bits)

abs: Absolute address (8, 16, 24, or 32 bits)

disp: Displacement (8, 16, or 32 bits)

rs, rd, rn: Register field (4 bits specifying an 8-bit or 16-bit register. The symbols rs, rd, and rn correspond to operand symbols Rs, Rd, and Rn.)

ers, erd, erm, erm: Register field (3 bits specifying an address register or 32-bit register. The symbols ers, erd, erm, and erm correspond to operand symbols ERs, ERd, ERn, and ERm.)

The register fields specify general registers as follows.

Address Register		16-Bit Register		8-Bit Register	
Register Field	General Register	Register Field	General Register	Register Field	General Register
000	ER0	0000	R0	0000	R0H
001	ER1	0001	R1	0001	R1H
.	.	.	.	.	.
.	.	.	.	.	.
111	ER7	0111	R7	0111	R7H
		1000	E0	1000	R0L
		1001	E1	1001	R1L
		.	.	.	.
		1111	E7	1111	R7L

## 2.5 Operation Code Map

Table 2.3 shows an operation code map.

**Table 2.3 Operation Code Map (1)**

Operation Code:		1st byte		2nd byte		Instruction when most significant bit of BH is 0.														Instruction when most significant bit of BH is 1.	
AL/AH	0	1	2	3	4	5	6	7	8	9	A	B	C	D	E	F					
0	NOP	Table 2.3 (2)	STC	LDC	ORC	XORC	ANDC	LDC	ADD	Table 2.3 (2)	Table 2.3 (2)	Table 2.3 (2)	MOV		ADDC	Table 2.3 (2)					
1	Table 2.3 (2)	Table 2.3 (2)	Table 2.3 (2)	Table 2.3 (2)	OR	XOR	AND	Table 2.3 (2)	SUB	Table 2.3 (2)	Table 2.3 (2)	Table 2.3 (2)	CMP		SUBX	Table 2.3 (2)					
2																					
3																					
4	BRA	BRN	BHI	BLS	BCC	BCS	BNE	BEQ	BVC	BVS	BPL	BMI	BGE	BLT	BGT	BLE					
5	MULXU	DIVXU	MULXU	DIVXU	RTS	BSR	RTE	TRAPA	Table 2.3 (2)		JMP		BSR		JSR						
6	BSET	BNOT	BCLR	BTST	OR	XOR	AND	BST	MOV	Table 2.3 (2)											
7					BOR	BXOR	BAND	BILD	MOV	Table 2.3 (2)	Table 2.3 (2)	EEMOV				Table 2.3 (3)					
8									ADD												
9									ADDC												
A									CMP												
B									SUBX												
C									OR												
D									XOR												
E									AND												
F									MOV												

Note: \* These instructions are supported by the H8S/2600 CPU only.



**Table 2.3 Operation Code Map (2)**

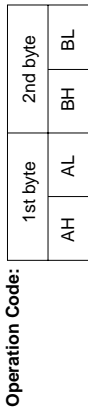

BH	0	1	2	3	4	5	6	7	8	9	A	B	C	D	E	F
AH/AL	MOV	LDM		LDC	STC		MAC*		SLEEP		CLR/MAC*					
01	MOV			STM												Table 2.3 (9)
0A	INC												ADD			
0B	ADDS					INC		INC	ADDS					INC		INC
0F	DAA															
10	SHLL				SHLL			SHLL	SHAL				SHAL			SHAL
11	SHLR				SHLR			SHLR	SHAR				SHAR			SHAR
12	ROTXL				ROTXL			ROTXL	ROTL				ROTL			ROTL
13	ROTXR				ROTXR			ROTXR	ROTR				ROTR			ROTR
17	NOT					EXTU		EXTU	NEG			NEG		EXTS		EXTS
1A	DEC															
1B	SUBS					DEC		DEC	SUBS					DEC		DEC
1F	DAS															
58	BRA	BRN	BHI	BLS	BCC	BCS	BNE	BEQ	BVC	BVS	BPL	BMI	BGE	BLT	BGT	BLE
6A	MOV	Table 2.3 (4)	MOV	Table 2.3 (4)	MOV/PE				MOV		MOV					
79	MOV	ADD	CMP	SUB	OR	XOR	AND									
7A	MOV	ADD	CMP	SUB	OR	XOR	AND									

Note: \* These instructions are supported by the H8S/2600 CPU only.

**Table 2.3 Operation Code Map (3)**

**Operation Code:**

1st byte		2nd byte		3rd byte		4th byte	
AH	AL	BH	BL	CH	CL	DH	DL



CL	0	1	2	3	4	5	6	7	8	9	A	B	C	D	E	F
AH BH CH	MULXS		MULXS													
01C05	MULXS		MULXS													
01D05	DIVXS		DIVXS													
01F06					OR	XOR	AND									
7C06*1				BTST												
7C07*1				BTST	BOR	BXOR	BAND	BLD								
					BIOR	BIXOR	BIAND	BILD								
7D06*1	BSET	BNOT	BCLR					BST								
7D07*1	BSET	BNOT	BCLR					BST								
7Eaa6*2				BTST												
7Eaa7*2				BTST	BOR	BXOR	BAND	BLD								
					BIOR	BIXOR	BIAND	BILD								
7Faa6*2	BSET	BNOT	BCLR					BST								
7Faa7*2	BSET	BNOT	BCLR					BST								

Notes: 1. The letter "r" indicates a register field.  
 2. The letters "aa" indicate an absolute address field.

**Table 2.3 Operation Code Map (4)**

**Operation Code:**

1st byte		2nd byte		3rd byte		4th byte		5th byte		6th byte	
AH	AL	BH	BL	CH	CL	DH	DL	EH	EL	FH	FL

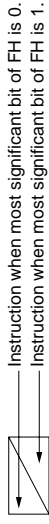

EL	0	1	2	3	4	5	6	7	8	9	A	B	C	D	E	F
AHALHBL...CHCLDHLER				BTST	BOR BIXOR	BAND BIAND	BLD BILD	BST BIST								
6A10aaaa6*																
6A10aaaa7*																
6A18aaaa6*	BSET	BNOT	BCLR													
6A18aaaa7*																

**Operation Code:**

1st byte		2nd byte		3rd byte		4th byte		5th byte		6th byte		7th byte		8th byte	
AH	AL	BH	BL	CH	CL	DH	DL	EH	EL	FH	FL	GH	GL	HH	HL

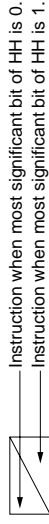

EL	0	1	2	3	4	5	6	7	8	9	A	B	C	D	E	F
AHALHBL...FHLGH				BTST	BOR BIXOR	BAND BIAND	BLD BILD	BST BIST								
6A30aaaaaaaa6*																
6A30aaaaaaaa7*																
6A38aaaaaaaa6*	BSET	BNOT	BCLR													
6A38aaaaaaaa7*																

Note: \* The letters "aa" indicate an absolute address field.

## 2.6 Number of States Required for Instruction Execution

The tables in this section can be used to calculate the number of states required for instruction execution by the CPU. Table 2.5 indicates the number of instruction fetch, data read/write, and other cycles occurring in each instruction. Table 2.4 indicates the number of states required for each cycle, depending on its size. The number of states required for each cycle depends on the product. See the hardware manual named for the relevant product for details. The number of states required for execution of an instruction can be calculated from these two tables as follows:

$$\text{Execution states} = I \times S_1 + J \times S_j + K \times S_k + L \times S_L + M \times S_M + N \times S_N$$

**Examples:** Advanced mode, program code and stack located in external memory, on-chip supporting modules accessed in two states with 8-bit bus width, external devices accessed in three states with one wait state and 16-bit bus width.

### 1. BSET #0, @FFFFC7:8

From table 2.5:

$$I = L = 2, \quad J = K = M = N = 0$$

From table 2.4:

$$S_1 = 4, \quad S_L = 2$$

$$\text{Number of states required for execution} = 2 \times 4 + 2 \times 2 = 12$$

### 2. JSR @@30

From table 2.5:

$$I = J = K = 2, \quad L = M = N = 0$$

From table 2.4:

$$S_1 = S_j = S_k = 4$$

$$\text{Number of states required for execution} = 2 \times 4 + 2 \times 4 + 2 \times 4 = 24$$

**Table 2.4 Number of States per Cycle**

			Access Conditions					
			On-Chip Supporting Module		External Device			
					8-Bit Bus		16-Bit Bus	
Cycle	On-Chip Memory	8-Bit Bus	16-Bit Bus	2-State Access	3-State Access	2-State Access	3-State Access	
Instruction fetch	$S_i$	1	2n	n	4	6 + 2m	2	3 + m*
Branch address read	$S_j$							
Stack operation	$S_k$							
Byte data access	$S_L$		n		2	3 + m		
Word data access	$S_M$		2n		4	6 + 2m		
Internal operation	$S_N$	1	1	1	1	1	1	1

Note: \* For the MOVFPE and MOVTPPE instructions, refer to the relevant microcontroller hardware manual.

**Legend**

m: Number of wait states inserted into external device access

n: Number of states required for access to an on-chip supporting module. For the specific number, refer to the relevant microcontroller hardware manual.

**Table 2.5 Number of Cycles in Instruction Execution**

Instruction	Mnemonic	Instruction	Branch	Stack	Byte Data	Word Data	Internal
		Fetch	Address	Operation	Access	Access	Operation
		I	J	K	L	M	N
ADD	ADD.B #xx:8,Rd	1					
	ADD.B Rs,Rd	1					
	ADD.W #xx:16,Rd	2					
	ADD.W Rs,Rd	1					
	ADD.L #xx:32,ERd	3					
	ADD.L ERs,ERd	1					
ADDS	ADDS #1/2/4,ERd	1					
ADDX	ADDX #xx:8,Rd	1					
	ADDX Rs,Rd	1					
AND	AND.B #xx:8,Rd	1					
	AND.B Rs,Rd	1					
	AND.W #xx:16,Rd	2					
	AND.L #xx:32,ERd	3					
	AND.L ERs,ERd	2					
ANDC	ANDC #xx:8,CCR	1					
	ANDC #xx:8,EXR	2					
BAND	BAND #xx:3,Rd	1					
	BAND #xx:3,@ERd	2			1		
	BAND #xx:3,@aa:8	2			1		
	BAND #xx:3,@aa:16	3			1		
	BAND #xx:3,@aa:32	4			1		
Bcc	BRA d:8 (BT d:8)	2					
	BRN d:8 (BF d:8)	2					
	BHI d:8	2					
	BLS d:8	2					
	BCC d:8 (BHS d:8)	2					
	BCS d:8 (BLO d:8)	2					
	BNE d:8	2					
	BEQ d:8	2					
	BVC d:8	2					
	BVS d:8	2					
	BPL d:8	2					
	BMI d:8	2					
	BGE d:8	2					
	BLT d:8	2					
	BGT d:8	2					
	BLE d:8	2					
	BRA d:16 (BT d:16)	2					1
	BRN d:16 (BF d:16)	2					1

Instruction	Mnemonic	Instruction	Branch	Stack	Byte Data	Word Data	Internal
		Fetch	Address	Operation	Access	Access	Operation
		I	J	K	L	M	N
Bcc	BHI d:16	2					1
	BLS d:16	2					1
	BCC d:16 (BHS d:16)	2					1
	BCS d:16 (BLO d:16)	2					1
	BNE d:16	2					1
	BEQ d:16	2					1
	BVC d:16	2					1
	BVS d:16	2					1
	BPL d:16	2					1
	BMI d:16	2					1
	BGE d:16	2					1
	BLT d:16	2					1
	BGT d:16	2					1
BLE d:16	2					1	
BCLR	BCLR #xx:3,Rd	1					
	BCLR #xx:3,@ERd	2			2		
	BCLR #xx:3,@aa:8	2			2		
	BCLR #xx:3,@aa:16	3			2		
	BCLR #xx:3,@aa:32	4			2		
	BCLR Rn,Rd	1					
	BCLR Rn,@ERd	2			2		
	BCLR Rn,@aa:8	2			2		
	BCLR Rn,@aa:16	3			2		
BCLR Rn,@aa:32	4			2			
BIAND	BIAND #xx:3,Rd	1					
	BIAND #xx:3,@ERd	2			1		
	BIAND #xx:3,@aa:8	2			1		
	BIAND #xx:3,@aa:16	3			1		
	BIAND #xx:3,@aa:32	4			1		
BILD	BILD #xx:3,Rd	1					
	BILD #xx:3,@ERd	2			1		
	BILD #xx:3,@aa:8	2			1		
	BILD #xx:3,@aa:16	3			1		
	BILD #xx:3,@aa:32	4			1		
BIOR	BIOR #xx:8,Rd	1					
	BIOR #xx:8,@ERd	2			1		
	BIOR #xx:8,@aa:8	2			1		
	BIOR #xx:8,@aa:16	3			1		
	BIOR #xx:8,@aa:32	4			1		

Instruction	Mnemonic	Branch					
		Instruction Fetch	Address Read	Stack Operation	Byte Data Access	Word Data Access	Internal Operation
		I	J	K	L	M	N
BIST	BIST #xx:3,Rd	1					
	BIST #xx:3,@ERd	2			2		
	BIST #xx:3,@aa:8	2			2		
	BIST #xx:3,@aa:16	3			2		
	BIST #xx:3,@aa:32	4			2		
BIXOR	BIXOR #xx:3,Rd	1					
	BIXOR #xx:3,@ERd	2			1		
	BIXOR #xx:3,@aa:8	2			1		
	BIXOR #xx:3,@aa:16	3			1		
	BIXOR #xx:3,@aa:32	4			1		
BLD	BLD #xx:3,Rd	1					
	BLD #xx:3,@ERd	2			1		
	BLD #xx:3,@aa:8	2			1		
	BLD #xx:3,@aa:16	3			1		
	BLD #xx:3,@aa:32	4			1		
BNOT	BNOT #xx:3,Rd	1					
	BNOT #xx:3,@ERd	2			2		
	BNOT #xx:3,@aa:8	2			2		
	BNOT #xx:3,@aa:16	3			2		
	BNOT #xx:3,@aa:32	4			2		
	BNOT Rn,Rd	1					
	BNOT Rn,@ERd	2			2		
	BNOT Rn,@aa:8	2			2		
	BNOT Rn,@aa:16	3			2		
BNOT Rn,@aa:32	4			2			
BOR	BOR #xx:3,Rd	1					
	BOR #xx:3,@ERd	2			1		
	BOR #xx:3,@aa:8	2			1		
	BOR #xx:3,@aa:16	3			1		
	BOR #xx:3,@aa:32	4			1		
BSET	BSET #xx:3,Rd	1					
	BSET #xx:3,@ERd	2			2		
	BSET #xx:3,@aa:8	2			2		
	BSET #xx:3,@aa:16	3			2		
	BSET #xx:3,@aa:32	4			2		
	BSET Rn,Rd	1					
	BSET Rn,@ERd	2			2		
	BSET Rn,@aa:8	2			2		
	BSET Rn,@aa:16	3			2		
BSET Rn,@aa:32	4			2			



Instruction	Mnemonic		Instruction	Branch	Stack	Byte Data	Word Data	Internal
			Fetch	Address	Operation	Access	Access	Operation
			I	J	K	L	M	N
BSR	BSR d:8	Normal	2		1			
		Advanced	2		2			
	BSR d:16	Normal	2		1			1
		Advanced	2		2			1
BST	BST #xx:3,Rd		1					
	BST #xx:3,@ERd		2			2		
	BST #xx:3,@aa:8		2			2		
	BST #xx:3,@aa:16		3			2		
	BST #xx:3,@aa:32		4			2		
BTST	BTST #xx:3,Rd		1					
	BTST #xx:3,@ERd		2			1		
	BTST #xx:3,@aa:8		2			1		
	BTST #xx:3,@aa:16		3			1		
	BTST #xx:3,@aa:32		4			1		
	BTST Rn,Rd		1					
	BTST Rn,@ERd		2			1		
	BTST Rn,@aa:8		2			1		
	BTST Rn,@aa:16		3			1		
BTST Rn,@aa:32		4			1			
BXOR	BXOR #xx:3,Rd		1					
	BXOR #xx:3,@ERd		2			1		
	BXOR #xx:3,@aa:8		2			1		
	BXOR #xx:3,@aa:16		3			1		
	BXOR #xx:3,@aa:32		4			1		
CLRMAC*	CLRMAC		1					1* <sup>3</sup>
CMP	CMP.B #xx:8,Rd		1					
	CMP.B Rs,Rd		1					
	CMP.W #xx:16,Rd		2					
	CMP.W Rs,Rd		1					
	CMP.L #xx:32,ERd		3					
	CMP.L ERs,ERd		1					
DAA	DAA Rd		1					
DAS	DAS Rd		1					
DEC	DEC.B Rd		1					
	DEC.W #1/2,Rd		1					
	DEC.L #1/2,ERd		1					
DIVXS	DIVXS.B Rs,Rd		2					11
	DIVXS.W Rs,ERd		2					19
DIVXU	DIVXU.B Rs,Rd		1					11
	DIVXU.W Rs,ERd		1					19

Instruction	Mnemonic	Branch						
		Instruction Fetch	Address Read	Stack Operation	Byte Data Access	Word Data Access	Internal Operation	
		I	J	K	L	M	N	
EEPMOV	EEPMOV.B	2			$2n + 2^{*1}$			
	EEPMOV.W	2			$2n + 2^{*1}$			
EXTS	EXTS.W Rd	1						
	EXTS.L ERd	1						
EXTU	EXTU.W Rd	1						
	EXTU.L ERd	1						
INC	INC.B Rd	1						
	INC.W #1/2,Rd	1						
	INC.L #1/2,ERd	1						
JMP	JMP @ERn	2						
	JMP @aa:24	2					1	
	JMP @@aa:8	Normal	2	1				1
		Advanced	2	2				1
JSR	JSR @ERn	Normal	2		1			
		Advanced	2		2			
	JSR @aa:24	Normal	2		1			1
		Advanced	2		2			1
	JSR @@aa:8	Normal	2	1	1			
		Advanced	2	2	2			
LDC	LDC #xx:8,CCR	1						
	LDC #xx:8,EXR	2						
	LDC Rs,CCR	1						
	LDC Rs,EXR	1						
	LDC @ERs,CCR	2				1		
	LDC @ERs,EXR	2				1		
	LDC @(d:16,ERs),CCR	3				1		
	LDC @(d:16,ERs),EXR	3				1		
	LDC @(d:32,ERs),CCR	5				1		
	LDC @(d:32,ERs),EXR	5				1		
	LDC @ERs+,CCR	2				1	1	
	LDC @ERs+,EXR	2				1	1	
	LDC @aa:16,CCR	3				1		
	LDC @aa:16,EXR	3				1		
	LDC @aa:32,CCR	4				1		
	LDC @aa:32,EXR	4				1		
LDM	LDM.L @SP+,(ERn-ERn+1)	2		4			1	
	LDM.L @SP+,(ERn-ERn+2)	2		6			1	
	LDM.L @SP+,(ERn-ERn+3)	2		8			1	
LDMAC*	LDMAC ERs,MACH	1					1* <sup>3</sup>	
	LDMAC ERs,MACL	1					1* <sup>3</sup>	

Instruction	Mnemonic	Instruction	Branch	Stack	Byte Data	Word Data	Internal	
		Fetch	Address	Operation	Access	Access	Operation	
		I	J	K	L	M	N	
MAC*	MAC @ERn+,@ERm+	2				2		
MOV	MOV.B #xx:8,Rd	1						
	MOV.B Rs,Rd	1						
	MOV.B @ERs,Rd	1			1			
	MOV.B @(d:16,ERs),Rd	2			1			
	MOV.B @(d:32,ERs),Rd	4			1			
	MOV.B @ERs+,Rd	1			1		1	
	MOV.B @aa:8,Rd	1			1			
	MOV.B @aa:16,Rd	2			1			
	MOV.B @aa:32,Rd	3			1			
	MOV.B Rs,@ERd	1			1			
	MOV.B Rs,@(d:16,ERd)	2			1			
	MOV.B Rs,@(d:32,ERd)	4			1			
	MOV.B Rs,@-ERd	1			1		1	
	MOV.B Rs,@aa:8	1			1			
	MOV.B Rs,@aa:16	2			1			
	MOV.B Rs,@aa:32	3			1			
	MOV.W #xx:16,Rd	2						
	MOV.W Rs,Rd	1						
	MOV.W @ERs,Rd	1					1	
	MOV.W @(d:16,ERs),Rd	2					1	
	MOV.W @(d:32,ERs),Rd	4					1	
	MOV.W @ERs+,Rd	1					1	1
	MOV.W @aa:16,Rd	2					1	
	MOV.W @aa:32,Rd	3					1	
	MOV.W Rs,@ERd	1					1	
	MOV.W Rs,@(d:16,ERd)	2					1	
	MOV.W Rs,@(d:32,ERd)	4					1	
	MOV.W Rs,@-ERd	1					1	1
	MOV.W Rs,@aa:16	2					1	
	MOV.W Rs,@aa:32	3					1	
	MOV.L #xx:32,ERd	3						
	MOV.L ERs,ERd	1						
	MOV.L @ERs,ERd	2					2	
	MOV.L @(d:16,ERs),ERd	3					2	
MOV.L @(d:32,ERs),ERd	5					2		
MOV.L @ERs+,ERd	2					2	1	
MOV.L @aa:16,ERd	3					2		
MOV.L @aa:32,ERd	4					2		
MOV.L ERs,@ERd	2					2		

Instruction	Mnemonic	Instruction Fetch	Branch		Stack Operation	Byte Data Access	Word Data Access	Internal Operation
			Address Read	Stack Operation				
		I	J	K	L	M	N	
MOV	MOV.L ERs, @(d:16,ERd)	3				2		
	MOV.L ERs, @(d:32,ERd)	5				2		
	MOV.L ERs, @-ERd	2				2	1	
	MOV.L ERs, @aa:16	3				2		
	MOV.L ERs, @aa:32	4				2		
MOVFPE	MOVFPE @:aa:16,Rd	2			1* <sup>2</sup>			
MOVTPE	MOVTPE Rs, @:aa:16	2			1* <sup>2</sup>			
MULXS	MULXS.B Rs,Rd H8S/2600	2					2* <sup>3</sup>	
	H8S/2000	2					11	
	MULXS.W Rs,ERd H8S/2600	2					3* <sup>3</sup>	
	H8S/2000	2					19	
MULXU	MULXU.B Rs,Rd H8S/2600	1					2* <sup>3</sup>	
	H8S/2000	1					11	
	MULXU.W Rs,ERd H8S/2600	1					3* <sup>3</sup>	
	H8S/2000	1					19	
NEG	NEG.B Rd	1						
	NEG.W Rd	1						
	NEG.L ERd	1						
NOP	NOP	1						
NOT	NOT.B Rd	1						
	NOT.W Rd	1						
	NOT.L ERd	1						
OR	OR.B #xx:8,Rd	1						
	OR.B Rs,Rd	1						
	OR.W #xx:16,Rd	2						
	OR.W Rs,Rd	1						
	OR.L #xx:32,ERd	3						
	OR.L ERs,ERd	2						
ORC	ORC #xx:8,CCR	1						
	ORC #xx:8,EXR	2						
POP	POP.W Rn	1				1	1	
	POP.L ERn	2				2	1	
PUSH	PUSH.W Rn	1				1	1	
	PUSH.L ERn	2				2	1	
ROTL	ROTL.B Rd	1						
	ROTL.B #2,Rd	1						
	ROTL.W Rd	1						
	ROTL.W #2,Rd	1						
	ROTL.L ERd	1						
	ROTL.L #2,ERd	1						

Instruction	Mnemonic	Instruction Fetch	Branch	Stack Operation	Byte Data Access	Word Data Access	Internal Operation
			Address Read				
		I	J	K	L	M	N
ROTR	ROTR.B Rd	1					
	ROTR.B #2,Rd	1					
	ROTR.W Rd	1					
	ROTR.W #2,Rd	1					
	ROTR.L ERd	1					
	ROTR.L #2,ERd	1					
ROTXL	ROTXL.B Rd	1					
	ROTXL.B #2,Rd	1					
	ROTXL.W Rd	1					
	ROTXL.W #2,Rd	1					
	ROTXL.L ERd	1					
	ROTXL.L #2,ERd	1					
ROTXR	ROTXR.B Rd	1					
	ROTXR.B #2,Rd	1					
	ROTXR.W Rd	1					
	ROTXR.W #2,Rd	1					
	ROTXR.L ERd	1					
	ROTXR.L #2,ERd	1					
RTE	RTE	2		2/3 *1			1
RTS	RTS	Normal	2		1		1
		Advanced	2		2		1
SHAL	SHAL.B Rd	1					
	SHAL.B #2,Rd	1					
	SHAL.W Rd	1					
	SHAL.W #2,Rd	1					
	SHAL.L ERd	1					
	SHAL.L #2,ERd	1					
SHAR	SHAR.B Rd	1					
	SHAR.B #2,Rd	1					
	SHAR.W Rd	1					
	SHAR.W #2,Rd	1					
	SHAR.L ERd	1					
	SHAR.L #2,ERd	1					
SHLL	SHLL.B Rd	1					
	SHLL.B #2,Rd	1					
	SHLL.W Rd	1					
	SHLL.W #2,Rd	1					
	SHLL.L ERd	1					
	SHLL.L #2,ERd	1					

Instruction	Mnemonic	Instruction Fetch	Branch				
			Address Read	Stack Operation	Byte Data Access	Word Data Access	Internal Operation
		I	J	K	L	M	N
SHLR	SHLR.B Rd	1					
	SHLR.B #2,Rd	1					
	SHLR.W Rd	1					
	SHLR.W #2,Rd	1					
	SHLR.L ERd	1					
	SHLR.L #2,ERd	1					
SLEEP	SLEEP	1					1
STC	STC.B CCR,Rd	1					
	STC.B EXR,Rd	1					
	STC.W CCR,@ERd	2				1	
	STC.W EXR,@ERd	2				1	
	STC.W CCR,@(d:16,ERd)	3				1	
	STC.W EXR,@(d:16,ERd)	3				1	
	STC.W CCR,@(d:32,ERd)	5				1	
	STC.W EXR,@(d:32,ERd)	5				1	
	STC.W CCR,@-ERd	2				1	1
	STC.W EXR,@-ERd	2				1	1
	STC.W CCR,@aa:16	3				1	
	STC.W EXR,@aa:16	3				1	
	STC.W CCR,@aa:32	4				1	
	STC.W EXR,@aa:32	4				1	
STM	STM.L (ERn-ERn+1),@-SP	2		4			1
	STM.L(ERn-ERn+2),@-SP	2		6			1
	STM.L(ERn-ERn+3),@-SP	2		8			1
STMAC*	STMAC MACH,ERd	1					0* <sup>3</sup>
	STMAC MACL,ERd	1					0* <sup>3</sup>
SUB	SUB.B Rs,Rd	1					
	SUB.W #xx:16,Rd	2					
	SUB.W Rs,Rd	1					
	SUB.L #xx:32,ERd	3					
	SUB.L ERs,ERd	1					
SUBS	SUBS #1/2/4,ERd	1					
SUBX	SUBX #xx:8,Rd	1					
	SUBX Rs,Rd	1					
TAS	TAS @ERd* <sup>4</sup>	2			2		
TRAPA	TRAPA #x:2	Normal	2	1	2/3 * <sup>1</sup>		2
		Advanced	2	2	2/3 * <sup>1</sup>		2

Instruction	Mnemonic	Instruction	Branch	Stack	Byte Data	Word Data	Internal
		Fetch	Address	Operation	Access	Access	Operation
		I	J	K	L	M	N
XOR	XOR.B #xx:8,Rd	1					
	XOR.B Rs,Rd	1					
	XOR.W #xx:16,Rd	2					
	XOR.W Rs,Rd	1					
	XOR.L #xx:32,ERd	3					
	XOR.L ERs,ERd	2					
XORC	XORC #xx:8,CCR	1					
XORC	XORC #xx:8,EXR	2					

Notes: \* These instructions are supported by the H8S/2600 CPU only.

1. 2 when EXR is invalid, 3 when EXR is valid.
2. 5 for concatenated execution, 4 otherwise.
3. An internal operation may require between 0 and 3 additional states, depending on the preceding instruction.
4. Only register ER0, ER1, ER4, or ER5 should be used when using the TAS instruction.

## 2.7 Bus States During Instruction Execution

Table 2.6 indicates the types of cycles that occur during instruction execution by the CPU. See table 2.4 for the number of states per cycle.

### How to Read the Table:

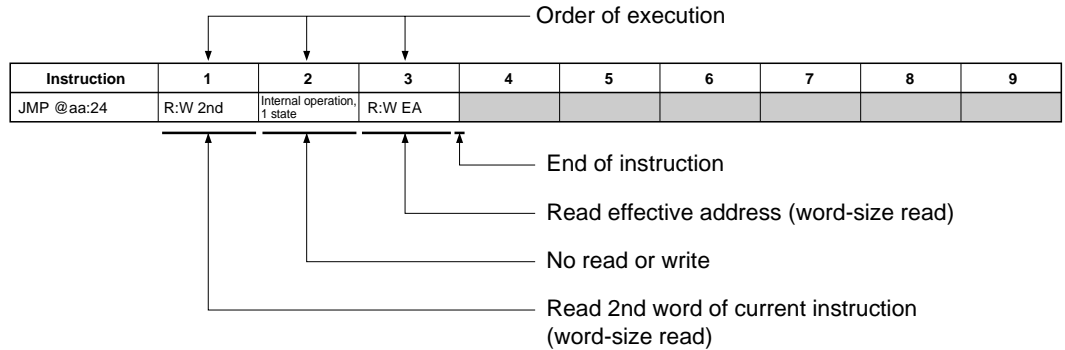

### Legend

R:B	Byte-size read
R:W	Word-size read
W:B	Byte-size write
W:W	Word-size write
:M	Transfer of the bus is not performed immediately after this cycle
2nd	Address of 2nd word (3rd and 4th bytes)
3rd	Address of 3rd word (5th and 6th bytes)
4th	Address of 4th word (7th and 8th bytes)
5th	Address of 5th word (9th and 10th bytes)
NEXT	Address of next instruction
EA	Effective address
VEC	Vector address



Figure 2.1 shows timing waveforms for the address bus and the  $\overline{RD}$  and  $\overline{WR}$  ( $\overline{HWR}$  or  $\overline{LWR}$ ) signals during execution of the above instruction with an 8-bit bus, using three-state access with no wait states.

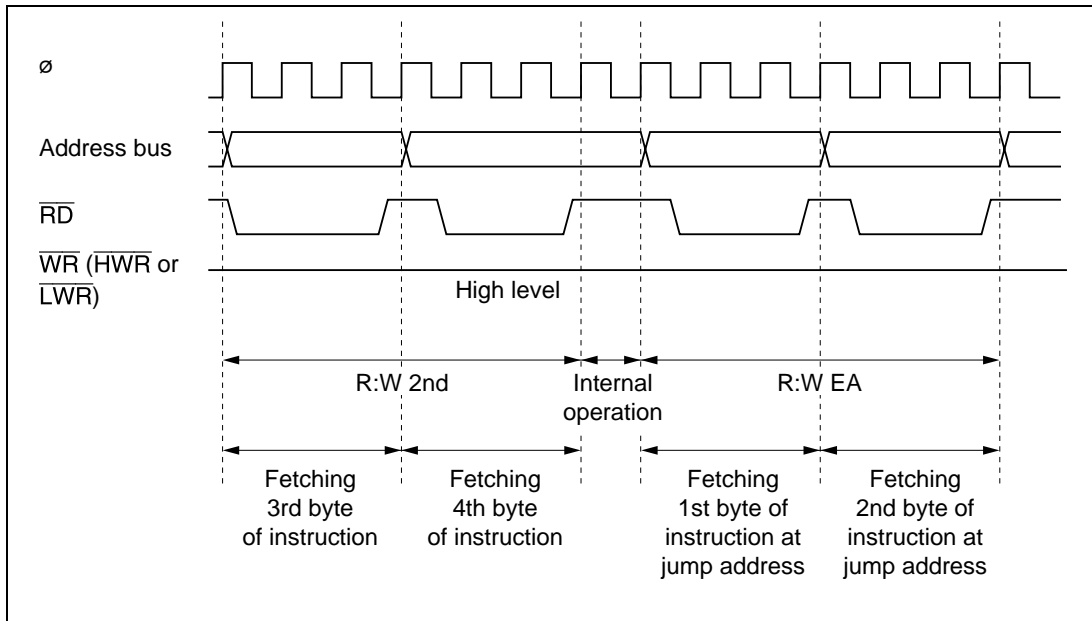

**Figure 2.1 Address Bus,  $\overline{RD}$ , and  $\overline{WR}$  ( $\overline{HWR}$  or  $\overline{LWR}$ ) Timing (8-Bit Bus, Three-State Access, No Wait States)**

**Table 2.6 Instruction Execution Cycles**

Instruction	1	2	3	4	5	6	7	8	9
ADD.B #xx:8,Rd	R:W NEXT								
ADD.B Rs,Rd	R:W NEXT								
ADD.W #xx:16,Rd	R:W 2nd	R:W NEXT							
ADD.W Rs,Rd	R:W NEXT								
ADD.L #xx:32,ERd	R:W 2nd	R:W 3rd	R:W NEXT						
ADD.L ERs,ERd	R:W NEXT								
ADD.S #1/2/4,ERd	R:W NEXT								
ADDX #xx:8,Rd	R:W NEXT								
ADDX Rs,Rd	R:W NEXT								
AND.B #xx:8,Rd	R:W NEXT								
AND.B Rs,Rd	R:W NEXT								
AND.W #xx:16,Rd	R:W 2nd	R:W NEXT							
AND.W Rs,Rd	R:W NEXT								
AND.L #xx:32,ERd	R:W 2nd	R:W 3rd	R:W NEXT						
AND.L ERs,ERd	R:W 2nd	R:W NEXT							
ANDC #xx:8,CCR	R:W NEXT								
ANDC #xx:8,EXR	R:W 2nd	R:W NEXT							
BAND #xx:3,Rd	R:W NEXT								
BAND #xx:3,@ERd	R:W 2nd	R:W 2nd	R:W NEXT						
BAND #xx:3,@aa:8	R:W 2nd	R:W 2nd	R:W NEXT						
BAND #xx:3,@aa:16	R:W 2nd	R:W 3rd	R:W 4th	R:W NEXT					
BAND #xx:3,@aa:32	R:W 2nd	R:W 3rd	R:W 4th	R:W 5th	R:W NEXT				
BRA d:8 (BT d:8)	R:W NEXT	R:W EA							
BRN d:8 (BF d:8)	R:W NEXT	R:W EA							
BHI d:8	R:W NEXT	R:W EA							
BLS d:8	R:W NEXT	R:W EA							
BCC d:8 (BHS d:8)	R:W NEXT	R:W EA							
BCS d:8 (BLO d:8)	R:W NEXT	R:W EA							
BNE d:8	R:W NEXT	R:W EA							
BEQ d:8	R:W NEXT	R:W EA							
BYC d:8	R:W NEXT	R:W EA							
BVS d:8	R:W NEXT	R:W EA							
BPL d:8	R:W NEXT	R:W EA							
BMI d:8	R:W NEXT	R:W EA							
BGE d:8	R:W NEXT	R:W EA							
BLT d:8	R:W NEXT	R:W EA							
BGT d:8	R:W NEXT	R:W EA							

Instruction	1	2	3	4	5	6	7	8	9
BLE d:8	R:W NEXT	R:W EA							
BRA d:16 (BT d:16)	R:W 2nd	Internal operation, 1 state	R:W EA						
BRN d:16 (BF d:16)	R:W 2nd	Internal operation, 1 state	R:W EA						
BHI d:16	R:W 2nd	Internal operation, 1 state	R:W EA						
BLS d:16	R:W 2nd	Internal operation, 1 state	R:W EA						
BCC d:16 (BHS d:16)	R:W 2nd	Internal operation, 1 state	R:W EA						
BCS d:16 (BLO d:16)	R:W 2nd	Internal operation, 1 state	R:W EA						
BNE d:16	R:W 2nd	Internal operation, 1 state	R:W EA						
BEQ d:16	R:W 2nd	Internal operation, 1 state	R:W EA						
BVC d:16	R:W 2nd	Internal operation, 1 state	R:W EA						
BVS d:16	R:W 2nd	Internal operation, 1 state	R:W EA						
BPL d:16	R:W 2nd	Internal operation, 1 state	R:W EA						
BMI d:16	R:W 2nd	Internal operation, 1 state	R:W EA						
BGE d:16	R:W 2nd	Internal operation, 1 state	R:W EA						
BLT d:16	R:W 2nd	Internal operation, 1 state	R:W EA						
BGT d:16	R:W 2nd	Internal operation, 1 state	R:W EA						
BLE d:16	R:W 2nd	Internal operation, 1 state	R:W EA						
BCLR #xx:3:Rd	R:W NEXT								
BCLR #xx:3:@ERd	R:W 2nd	R:B:M EA	R:W:M NEXT	W:B EA					
BCLR #xx:3:@aa:8	R:W 2nd	R:B:M EA	R:W:M NEXT	W:B EA					
BCLR #xx:3:@aa:16	R:W 2nd	R:W:3rd	R:B:M EA	R:W:M NEXT	W:B EA				

Instruction	1	2	3	4	5	6	7	8	9
BCLR #xx:3,@aa:32	R:W 2nd	R:W 3rd	R:W 4th	R:B:M EA	R:W:M NEXT	W:B EA			
BCLR Rn,Rd	R:W NEXT								
BCLR Rn,@ERd	R:W 2nd	R:B:M EA	R:W:M NEXT	W:B EA					
BCLR Rn,@aa:8	R:W 2nd	R:B:M EA	R:W:M NEXT	W:B EA					
BCLR Rn,@aa:16	R:W 2nd	R:W 3rd	R:B:M EA	R:W:M NEXT	W:B EA				
BCLR Rn,@aa:32	R:W 2nd	R:W 3rd	R:W 4th	R:B:M EA	R:W:M NEXT	W:B EA			
BIAND #xx:3,Rd	R:W NEXT								
BIAND #xx:3,@ERd	R:W 2nd	R:B EA	R:W:M NEXT						
BIAND #xx:3,@aa:8	R:W 2nd	R:B EA	R:W:M NEXT						
BIAND #xx:3,@aa:16	R:W 2nd	R:W 3rd	R:B EA	R:W:M NEXT					
BIAND #xx:3,@aa:32	R:W 2nd	R:W 3rd	R:W 4th	R:B EA	R:W:M NEXT				
BILD #xx:3,Rd	R:W NEXT								
BILD #xx:3,@ERd	R:W 2nd	R:B EA	R:W:M NEXT						
BILD #xx:3,@aa:8	R:W 2nd	R:B EA	R:W:M NEXT						
BILD #xx:3,@aa:16	R:W 2nd	R:W 3rd	R:B EA	R:W:M NEXT					
BILD #xx:3,@aa:32	R:W 2nd	R:W 3rd	R:W 4th	R:B EA	R:W:M NEXT				
BIOR #xx:3,Rd	R:W NEXT								
BIOR #xx:3,@ERd	R:W 2nd	R:B EA	R:W:M NEXT						
BIOR #xx:3,@aa:8	R:W 2nd	R:B EA	R:W:M NEXT						
BIOR #xx:3,@aa:16	R:W 2nd	R:W 3rd	R:B EA	R:W:M NEXT					
BIOR #xx:3,@aa:32	R:W 2nd	R:W 3rd	R:W 4th	R:B EA	R:W:M NEXT				
BIST #xx:3,Rd	R:W NEXT								
BIST #xx:3,@ERd	R:W 2nd	R:B:M EA	R:W:M NEXT	W:B EA					
BIST #xx:3,@aa:8	R:W 2nd	R:B:M EA	R:W:M NEXT	W:B EA					
BIST #xx:3,@aa:16	R:W 2nd	R:W 3rd	R:B:M EA	R:W:M NEXT	W:B EA				
BIST #xx:3,@aa:32	R:W 2nd	R:W 3rd	R:W 4th	R:B:M EA	R:W:M NEXT	W:B EA			
BIXOR #xx:3,Rd	R:W NEXT								
BIXOR #xx:3,@ERd	R:W 2nd	R:B EA	R:W:M NEXT						
BIXOR #xx:3,@aa:8	R:W 2nd	R:B EA	R:W:M NEXT						
BIXOR #xx:3,@aa:16	R:W 2nd	R:W 3rd	R:B EA	R:W:M NEXT					
BIXOR #xx:3,@aa:32	R:W 2nd	R:W 3rd	R:W 4th	R:B EA	R:W:M NEXT				
BLD #xx:3,Rd	R:W NEXT								
BLD #xx:3,@ERd	R:W 2nd	R:B EA	R:W:M NEXT						
BLD #xx:3,@aa:8	R:W 2nd	R:B EA	R:W:M NEXT						
BLD #xx:3,@aa:16	R:W 2nd	R:W 3rd	R:B EA	R:W:M NEXT					
BLD #xx:3,@aa:32	R:W 2nd	R:W 3rd	R:W 4th	R:B EA	R:W:M NEXT				
BNOT #xx:3,Rd	R:W NEXT								

Instruction	1	2	3	4	5	6	7	8	9
BNOT #xx:3,@ERd	R:W 2nd	R:B:M EA	R:W:M NEXT	W:B EA					
BNOT #xx:3,@aa:8	R:W 2nd	R:B:M EA	R:W:M NEXT	W:B EA					
BNOT #xx:3,@aa:16	R:W 2nd	R:W 3rd	R:B:M EA	R:W:M NEXT	W:B EA				
BNOT #xx:3,@aa:32	R:W 2nd	R:W 3rd	R:W 4th	R:B:M EA	R:W:M NEXT	W:B EA			
BNOT Rn,Rd	R:W NEXT								
BNOT Rn,@ERd	R:W 2nd	R:B:M EA	R:W:M NEXT	W:B EA					
BNOT Rn,@aa:8	R:W 2nd	R:B:M EA	R:W:M NEXT	W:B EA					
BNOT Rn,@aa:16	R:W 2nd	R:W 3rd	R:B:M EA	R:W:M NEXT	W:B EA				
BNOT Rn,@aa:32	R:W 2nd	R:W 3rd	R:W 4th	R:B:M EA	R:W:M NEXT	W:B EA			
BOR #xx:3,Rd	R:W NEXT								
BOR #xx:3,@ERd	R:W 2nd	R:B EA	R:W:M NEXT						
BOR #xx:3,@aa:8	R:W 2nd	R:B EA	R:W:M NEXT						
BOR #xx:3,@aa:16	R:W 2nd	R:W 3rd	R:B EA	R:W:M NEXT					
BOR #xx:3,@aa:32	R:W 2nd	R:W 3rd	R:W 4th	R:B EA	R:W:M NEXT				
BSET #xx:3,Rd	R:W NEXT								
BSET #xx:3,@ERd	R:W 2nd	R:B:M EA	R:W:M NEXT	W:B EA					
BSET #xx:3,@aa:8	R:W 2nd	R:B:M EA	R:W:M NEXT	W:B EA					
BSET #xx:3,@aa:16	R:W 2nd	R:W 3rd	R:B:M EA	R:W:M NEXT	W:B EA				
BSET #xx:3,@aa:32	R:W 2nd	R:W 3rd	R:W 4th	R:B:M EA	R:W:M NEXT	W:B EA			
BSET Rn,Rd	R:W NEXT								
BSET Rn,@ERd	R:W 2nd	R:B:M EA	R:W:M NEXT	W:B EA					
BSET Rn,@aa:8	R:W 2nd	R:B:M EA	R:W:M NEXT	W:B EA					
BSET Rn,@aa:16	R:W 2nd	R:W 3rd	R:B:M EA	R:W:M NEXT	W:B EA				
BSET Rn,@aa:32	R:W 2nd	R:W 3rd	R:W 4th	R:B:M EA	R:W:M NEXT	W:B EA			
BSR d:8	Normal	R:W EA	W:W stack						
	Advanced	R:W NEXT	W:W stack (H)	W:W stack (L)					
BSR d:16	Normal	Internal operation, 1 state	R:W EA	W:W stack					
	Advanced	Internal operation, 1 state	R:W EA	W:W stack (H)	W:W stack (L)				
BST #xx:3,Rd	R:W NEXT								
BST #xx:3,@ERd	R:W 2nd	R:B:M EA	R:W:M NEXT	W:B EA					
BST #xx:3,@aa:8	R:W 2nd	R:B:M EA	R:W:M NEXT	W:B EA					
BST #xx:3,@aa:16	R:W 2nd	R:W 3rd	R:B:M EA	R:W:M NEXT	W:B EA				
BST #xx:3,@aa:32	R:W 2nd	R:W 3rd	R:W 4th	R:B EA	R:W NEXT	W:B EA			
BTST #xx:3,Rd	R:W NEXT								
BTST #xx:3,@ERd	R:W 2nd	R:B EA	R:W:M NEXT						

Instruction	1	2	3	4	5	6	7	8	9
BTST #xx:3,@aa:8	R:W 2nd	R:B EA	R:W/M NEXT						
BTST #xx:3,@aa:16	R:W 2nd	R:W 3rd	R:B EA	R:W/M NEXT					
BTST #xx:3,@aa:32	R:W 2nd	R:W 3rd	R:W 4th	R:B EA	R:W/M NEXT				
BTST Rn,Rd	R:W NEXT								
BTST Rn,@ERd	R:W 2nd	R:B EA	R:W/M NEXT						
BTST Rn,@aa:8	R:W 2nd	R:B EA	R:W/M NEXT						
BTST Rn,@aa:16	R:W 2nd	R:W 3rd	R:B EA	R:W/M NEXT					
BTST Rn,@aa:32	R:W 2nd	R:W 3rd	R:W 4th	R:B EA	R:W/M NEXT				
BXOR #xx:3,Rd	R:W NEXT								
BXOR #xx:3,@ERd	R:W 2nd	R:B EA	R:W/M NEXT						
BXOR #xx:3,@aa:8	R:W 2nd	R:B EA	R:W/M NEXT						
BXOR #xx:3,@aa:16	R:W 2nd	R:W 3rd	R:B EA	R:W/M NEXT					
BXOR #xx:3,@aa:32	R:W 2nd	R:W 3rd	R:W 4th	R:B EA	R:W/M NEXT				
CLRMAC*	R:W NEXT	Internal operation, 1 state*9							
CMPB #xx:8,Rd	R:W NEXT								
CMPB Rs,Rd	R:W NEXT								
CMPW #xx:16,Rd	R:W 2nd	R:W NEXT							
CMPW Rs,Rd	R:W NEXT								
CMP.L #xx:32,ERd	R:W 2nd		R:W NEXT						
CMP.L ERs,ERd	R:W NEXT								
DAA Rd	R:W NEXT								
DAS Rd	R:W NEXT								
DEC.B Rd	R:W NEXT								
DEC.W #1/2,Rd	R:W NEXT								
DEC.L #1/2,ERd	R:W NEXT								
DIVX.SB Rs,Rd	R:W 2nd	R:W NEXT	Internal operation, 11 states						
DIVX.SW Rs,ERd	R:W 2nd	R:W NEXT	Internal operation, 19 states						
DIVX.UB Rs,Rd	R:W NEXT	Internal operation, 11 states							
DIVX.UW Rs,ERd	R:W NEXT	Internal operation, 19 states							
EEPMOV.B	R:W 2nd	R:B EAs *1	R:B EAd *1	R:B EAs *2	W:B EAd *2	R:W NEXT			
EEPMOV.W	R:W 2nd	R:B EAs *1	R:B EAd *1	R:B EAs *2	W:B EAd *2	R:W NEXT			
EXTS.W Rd	R:W NEXT			← Repeated n times*3 →					
EXTS.L ERd	R:W NEXT								
EXTU.W Rd	R:W NEXT								
EXTU.L ERd	R:W NEXT								
INC.B Rd	R:W NEXT								

Instruction	1	2	3	4	5	6	7	8	9
INC.W #1/2,Rd	R:W NEXT								
INC.L #1/2,ERd	R:W NEXT								
JMP @ERn	R:W NEXT	R:W EA							
JMP @aa:24	R:W 2nd	Internal operation, 1 state	R:W EA						
JMP @:aa:8	R:W NEXT	R:W aa:8	Internal operation, 1 state	R:W EA					
	R:W NEXT	R:W:M aa:8	R:W aa:8	Internal operation, 1 state	R:W EA				
JSR @ERn	R:W NEXT	R:W EA	W:W stack						
	R:W NEXT	R:W EA	W:W:M stack (H)	W:W stack (L)					
JSR @aa:24	R:W 2nd	Internal operation, 1 state	R:W EA	W:W stack					
	R:W 2nd	Internal operation, 1 state	R:W EA	W:W:M stack (H)	W:W stack (L)				
JSR @:aa:8	R:W NEXT	R:W aa:8	W:W stack	R:W EA					
	R:W NEXT	R:W:M aa:8	R:W aa:8	W:W:M stack (H)	W:W stack (L)	R:W EA			
LDC #xx:8,CCR	R:W NEXT								
LDC #xx:8,EXR	R:W 2nd	R:W NEXT							
LDC Rs,CCR	R:W NEXT								
LDC Rs,EXR	R:W NEXT								
LDC @ERs,CCR	R:W 2nd	R:W NEXT	R:W EA						
LDC @ERs,EXR	R:W 2nd	R:W NEXT	R:W EA						
LDC @(d:16,ERs),CCR	R:W 2nd	R:W 3rd	R:W NEXT	R:W EA					
LDC @(d:16,ERs),EXR	R:W 2nd	R:W 3rd	R:W NEXT	R:W EA					
LDC @(d:32,ERs),CCR	R:W 2nd	R:W 3rd	R:W 4th	R:W 5th	R:W NEXT	R:W EA			
LDC @(d:32,ERs),EXR	R:W 2nd	R:W 3rd	R:W 4th	R:W 5th	R:W NEXT	R:W EA			
LDC @ERs+,CCR	R:W 2nd	R:W NEXT	Internal operation, 1 state	R:W EA					
LDC @ERs+,EXR	R:W 2nd	R:W NEXT	Internal operation, 1 state	R:W EA					
LDC @aa:16,CCR	R:W 2nd	R:W 3rd	R:W NEXT	R:W EA					
LDC @aa:16,EXR	R:W 2nd	R:W 3rd	R:W NEXT	R:W EA					
LDC @aa:32,CCR	R:W 2nd	R:W 3rd	R:W 4th	R:W NEXT	R:W EA				
LDC @aa:32,EXR	R:W 2nd	R:W 3rd	R:W 4th	R:W NEXT	R:W EA				
LDM.L @SP+,(ERn-ERn+1)	R:W 2nd	R:W:M NEXT	Internal operation, 1 state	R:W:M stack (H) <sup>3</sup>	R:W stack (L) <sup>3</sup>				

Instruction	1	2	3	4	5	6	7	8	9
LDM.L @SP+, (ERn-ERn+2)	R:W 2nd	R:W NEXT	Internal operation, 1 state	R:W stack (H) <sup>+3</sup>	R:W stack (L) <sup>+3</sup>				
LDM.L @SP+, (ERn-ERn+3)	R:W 2nd	R:W NEXT	Internal operation, 1 state	R:W stack (H) <sup>+3</sup>	R:W stack (L) <sup>+3</sup>				
LDMAC ERs, MACH*	R:W NEXT	Internal operation, 1 state <sup>+9</sup>		← Repeated n times <sup>+3</sup> →					
LDMAC ERs, MACL*	R:W NEXT	Internal operation, 1 state <sup>+9</sup>							
MAC @ERn+, @ERm+*	R:W 2nd	R:W NEXT	R:W EAn	R:W EAm					
MOV.B #xx:8, Rd	R:W NEXT								
MOV.B Rs, Rd	R:W NEXT								
MOV.B @ERs, Rd	R:W NEXT	R:B EA							
MOV.B @(d:16, ERs), Rd	R:W 2nd	R:W NEXT	R:B EA						
MOV.B @(d:32, ERs), Rd	R:W 2nd	R:W 3rd	R:W 4th	R:W NEXT	R:B EA				
MOV.B @ERs+, Rd	R:W NEXT	Internal operation, 1 state	R:B EA						
MOV.B @aa:8, Rd	R:W NEXT	R:B EA							
MOV.B @aa:16, Rd	R:W 2nd	R:W NEXT	R:B EA						
MOV.B @aa:32, Rd	R:W 2nd	R:W 3rd	R:W NEXT	R:B EA					
MOV.B Rs, @ERd	R:W NEXT	W:B EA							
MOV.B Rs, @(d:16, ERd)	R:W 2nd	R:W NEXT	W:B EA						
MOV.B Rs, @(d:32, ERd)	R:W 2nd	R:W 3rd	R:W 4th	R:W NEXT	W:B EA				
MOV.B Rs, @-ERd	R:W NEXT	Internal operation, 1 state	W:B EA						
MOV.B Rs, @aa:8	R:W NEXT	W:B EA							
MOV.B Rs, @aa:16	R:W 2nd	R:W NEXT	W:B EA						
MOV.B Rs, @aa:32	R:W 2nd	R:W 3rd	R:W NEXT	W:B EA					
MOV.W #xx:16, Rd	R:W 2nd	R:W NEXT		W:B EA					
MOV.W Rs, Rd	R:W NEXT								
MOV.W @ERs, Rd	R:W NEXT	R:W EA							
MOV.W @(d:16, ERs), Rd	R:W 2nd	R:W NEXT	R:W EA						
MOV.W @(d:32, ERs), Rd	R:W 2nd	R:W 3rd	R:W 4th	R:W NEXT	R:W EA				
MOV.W @ERs+, Rd	R:W NEXT	Internal operation, 1 state	R:W EA						
MOV.W @aa:16, Rd	R:W 2nd	R:W NEXT	R:W EA						
MOV.W @aa:32, Rd	R:W 2nd	R:W 3rd	R:W NEXT	R:B EA					
MOV.W Rs, @ERd	R:W NEXT	W:W EA							



Instruction	1	2	3	4	5	6	7	8	9
MOV/W Rs,@(d:16,ERd)	R:W 2nd	R:W NEXT	W:W EA						
MOV/W Rs,@(d:32,ERd)	R:W 2nd	R:W 3rd	R:E 4th	R:W NEXT	W:W EA				
MOV/W Rs,@aa:16	R:W 2nd	R:W NEXT	W:W EA						
MOV/W Rs,@aa:32	R:W 2nd	R:W 3rd	R:W NEXT	W:W EA					
MOV/W Rs,@-ERd	R:W NEXT	Internal operation, 1 state	W:W EA						
MOVL #x:32,ERd	R:W 2nd	R:W 3rd	R:W NEXT						
MOVL ERs,ERd	R:W NEXT								
MOVL @ERs,ERd	R:W 2nd	R:W:M NEXT	R:W:M EA	R:W EA+2					
MOVL @(d:16,ERs),ERd	R:W 2nd	R:W:M 3rd	R:W NEXT	R:W:M EA	R:W EA+2				
MOVL @(d:32,ERs),ERd	R:W 2nd	R:W:M 3rd	R:W:M 4th	R:W 5th	R:W NEXT	R:W:M EA	R:W EA+2		
MOVL @ERs+,ERd	R:W 2nd	R:W:M NEXT	Internal operation, 1 state	R:W:M EA	R:W EA+2				
MOVL @aa:16,ERd	R:W 2nd	R:W:M 3rd	R:W NEXT	R:W:M EA	R:W EA+2				
MOVL @aa:32,ERd	R:W 2nd	R:W:M 3rd	R:W 4th	R:W NEXT	R:W EA+2				
MOVL ERs,@ERd	R:W 2nd	R:W:M NEXT	W:W:M EA	W:W EA+2					
MOVL ERs,@(d:16,ERd)	R:W 2nd	R:W:M 3rd	R:W NEXT	W:W:M EA	W:W EA+2				
MOVL ERs,@(d:32,ERd)	R:W 2nd	R:W 3rd	R:W 4th	R:W 5th	R:W NEXT	W:W:M EA	W:W EA+2		
MOVL ERs,@-ERd	R:W 2nd	R:W:M NEXT	Internal operation, 1 state	W:W:M EA	W:W EA+2				
MOVL ERs,@aa:16	R:W 2nd	R:W:M 3rd	R:W NEXT	W:W:M EA	W:W EA+2				
MOV/FPE @aa:16,Rd	R:W 2nd	R:W NEXT	R:W 4th	R:W NEXT	W:W:M EA	W:W EA+2			
MOV/TPE Rs,@aa:16	R:W 2nd	R:W NEXT	W:B *4 EA						
MULXS.B Rs,Rd	H8S/2600	R:W 2nd	R:W NEXT	Internal operation, 2 states*9					
	H8S/2000	R:W 2nd	R:W NEXT	Internal operation, 11 states					
	H8S/2600	R:W 2nd	R:W NEXT	Internal operation, 3 states*9					
	H8S/2000	R:W 2nd	R:W NEXT	Internal operation, 19 states					
	H8S/2600	R:W 2nd	Internal operation, 2 states*9						
	H8S/2000	R:W NEXT	Internal operation, 11 states						
	H8S/2600	R:W NEXT	Internal operation, 3 states*9						
	H8S/2000	R:W NEXT	Internal operation, 19 states						
NEG.B Rd	R:W NEXT								
NEG.W Rd	R:W NEXT								
NEG.L ERd	R:W NEXT								
NOP	R:W NEXT								
NOTB Rd	R:W NEXT								

Instruction	1	2	3	4	5	6	7	8	9
NOTL Rd	R:W NEXT								
NOTL ERd	R:W NEXT								
OR.B #xx:8,Rd	R:W NEXT								
OR.L Rs,Rd	R:W NEXT								
OR.W #xx:16,Rd	R:W 2nd								
OR.W Rs,Rd	R:W NEXT								
OR.L #xx:32,ERd	R:W 2nd	R:W 3rd	R:W NEXT						
OR.L ERs,ERd	R:W 2nd	R:W NEXT							
ORC #xx:8,CCR	R:W NEXT								
ORC #xx:8,EXR	R:W 2nd	R:W NEXT							
POPW Rn	R:W NEXT	Internal operation, 1 state	R:W EA						
POPL ERn	R:W 2nd	R:W NEXT	Internal operation, 1 state	R:W M EA	R:W EA+2				
PUSH.W Rn	R:W NEXT	Internal operation, 1 state	W:W EA						
PUSH.L ERn	R:W 2nd	R:W M NEXT	Internal operation, :M	W:W M EA	W:W EA+2				
ROT.L B Rd	R:W NEXT								
ROT.L B #2,Rd	R:W NEXT								
ROT.L W Rd	R:W NEXT								
ROT.L W #2,Rd	R:W NEXT								
ROT.L L ERd	R:W NEXT								
ROT.L L #2,ERd	R:W NEXT								
ROTR.B Rd	R:W NEXT								
ROTR.B #2,Rd	R:W NEXT								
ROTR.W Rd	R:W NEXT								
ROTR.W #2,Rd	R:W NEXT								
ROTR.L ERd	R:W NEXT								
ROTR.L #2,ERd	R:W NEXT								
ROTXL.B Rd	R:W NEXT								
ROTXL.B #2,Rd	R:W NEXT								
ROTXL.W Rd	R:W NEXT								
ROTXL.W #2,Rd	R:W NEXT								
ROTXL.L ERd	R:W NEXT								
ROTXL.L #2,ERd	R:W NEXT								
ROTXR.B Rd	R:W NEXT								

Instruction	1	2	3	4	5	6	7	8	9
ROTXR.B #2,Rd	R:W NEXT								
ROTXR.W Rd	R:W NEXT								
ROTXR.W #2,Rd	R:W NEXT								
ROTXR.L ERd	R:W NEXT								
ROTXR.L #2,ERd	R:W NEXT								
RTE	R:W NEXT	R:W stack (EXR)	R:W stack (H)	R:W stack (L)	Internal operation, 1 state	R:W #5			
RTS	Normal	R:W stack	Internal operation, 1 state	R:W #5					
		Advanced	R:W stack (H)	R:W stack (L)	Internal operation, 1 state				
SHAL.B Rd	R:W NEXT								
SHAL.B #2,Rd	R:W NEXT								
SHAL.W Rd	R:W NEXT								
SHAL.W #2,Rd	R:W NEXT								
SHAL.L ERd	R:W NEXT								
SHAL.L #2,ERd	R:W NEXT								
SHAR.B Rd	R:W NEXT								
SHAR.B #2,Rd	R:W NEXT								
SHAR.W Rd	R:W NEXT								
SHAR.W #2,Rd	R:W NEXT								
SHAR.L ERd	R:W NEXT								
SHAR.L #2,ERd	R:W NEXT								
SHLL.B Rd	R:W NEXT								
SHLL.B #2,Rd	R:W NEXT								
SHLL.W Rd	R:W NEXT								
SHLL.W #2,Rd	R:W NEXT								
SHLL.L ERd	R:W NEXT								
SHLL.L #2,ERd	R:W NEXT								
SHLR.B Rd	R:W NEXT								
SHLR.B #2,Rd	R:W NEXT								
SHLR.W Rd	R:W NEXT								
SHLR.W #2,Rd	R:W NEXT								
SHLR.L ERd	R:W NEXT								
SHLR.L #2,ERd	R:W NEXT								
SLEEP	R:W NEXT	Internal operation, 1 state							
STC CCR,Rd	R:W NEXT								

Instruction	1	2	3	4	5	6	7	8	9
STC_EXR,Rd	R:W NEXT								
STC_CCR,@ERd	R:W 2nd	R:W NEXT	W:W EA						
STC_EXR,@ERd	R:W 2nd	R:W NEXT	W:W EA						
STC_CCR,@(d:16,ERd)	R:W 2nd	R:W 3rd	R:W NEXT	W:W EA					
STC_EXR,@(d:16,ERd)	R:W 2nd	R:W 3rd	R:W NEXT	W:W EA					
STC_CCR,@(d:32,ERd)	R:W 2nd	R:W 3rd	R:W 4th	R:W 5th	R:W NEXT	W:W EA			
STC_EXR,@(d:32,ERd)	R:W 2nd	R:W 3rd	R:W 4th	R:W 5th	R:W NEXT	W:W EA			
STC_CCR,@-ERd	R:W 2nd	R:W NEXT	Internal operation, 1 state	W:W EA					
STC_EXR,@-ERd	R:W 2nd	R:W NEXT	Internal operation, 1 state	W:W EA					
STC_CCR,@aa:16	R:W 2nd	R:W 3rd	R:W NEXT	W:W EA					
STC_EXR,@aa:16	R:W 2nd	R:W 3rd	R:W NEXT	W:W EA					
STC_CCR,@aa:32	R:W 2nd	R:W 3rd	R:W 4th	R:W NEXT	W:W EA				
STC_EXR,@aa:32	R:W 2nd	R:W 3rd	R:W 4th	R:W NEXT	W:W EA				
STMLL(ERn-ERn+1),@-SP	R:W 2nd	R:W:M NEXT	Internal operation, 1 state	W:W:M stack (H) <sup>-3</sup>	W:W stack (L) <sup>-3</sup>				
STMLL(ERn-ERn+2),@-SP	R:W 2nd	R:W:M NEXT	Internal operation, 1 state	W:W:M stack (H) <sup>-3</sup>	W:W stack (L) <sup>-3</sup>				
STMLL(ERn-ERn+3),@-SP	R:W 2nd	R:W:M NEXT	Internal operation, 1 state	W:W:M stack (H) <sup>-3</sup>	W:W stack (L) <sup>-3</sup>				
STMACH,ERd*	R:W NEXT	*9							
STMACL,ERd*	R:W NEXT	*9							
SUBB Rs,Rd	R:W NEXT								
SUB.W #x:16,Rd	R:W 2nd	R:W NEXT							
SUB.W Rs,Rd	R:W NEXT								
SUBL #x:32,ERd	R:W 2nd	R:W 3rd	R:W NEXT						
SUBL ERs,ERd	R:W NEXT								
SUBS #1/2,ERd	R:W NEXT								
SUBX #x:8,Rd	R:W NEXT								
SUBX Rs,Rd	R:W NEXT								
TAS @ERd <sup>10</sup>	R:W 2nd	R:W NEXT	R:B EA	W:B EA					
TRAPA #x:2	Normal	Internal operation, 1 state	W:W stack (L)	W:W stack (H)	W:W stack (EXR)	R:W VEC	Internal operation, 1 state	R:W <sup>-8</sup>	
	Advanced	Internal operation, 1 state	W:W stack (L)	W:W stack (H)	W:W stack (EXR)	R:W:M VEC	R:W VEC+2	Internal operation, 1 state	R:W <sup>-8</sup>
XOR.B #x:8,Rd	R:W NEXT								

Instruction	1	2	3	4	5	6	7	8	9
XOR.B Rs,Rd	R:W NEXT								
XOR.W #xx:16,Rd	R:W 2nd	R:W NEXT							
XOR.W Rs,Rd	R:W NEXT								
XOR.L #xx:32,ERd	R:W 2nd	R:W 3rd	R:W NEXT						
XOR.L ERs,ERd	R:W 2nd	R:W NEXT							
XORC #xx:8,CCR	R:W NEXT								
XORC #xx:8,EXR	R:W 2nd	R:W NEXT							
Reset exception handling	Normal	Internal operation, 1 state	Internal operation, R:W *6						
	Advanced	R:W VEC+2	Internal operation, 1 state	Internal operation, R:W *6					
Interrupt exception handling	Normal	Internal operation, 1 state	W:W stack (L)	W:W stack (H)	W:W stack (EXR)	R:W VEC	Internal operation, 1 state	Internal operation, R:W *8	
	Advanced	R:W *7	Internal operation, 1 state	W:W stack (L)	W:W stack (H)	W:W stack (EXR)	R:W VEC+2	Internal operation, 1 state	Internal operation, R:W *8

Notes: \* These instructions are supported by the H8S/2600 CPU only.

1. EAs is the contents of ER5. EAd is the contents of ER6.
2. EAs is the contents of ER5. EAd is the contents of ER6. Both registers are incremented by 1 after execution of the instruction. n is the initial value of R4L or R4. If n = 0, these bus cycles are not executed.
3. Repeated two times to save or restore two registers, three times for three registers, or four times for four registers.
4. For the number of states required for byte-size read or write, refer to the relevant microcontroller hardware manual.
5. Start address after return.
6. Start address of the program.
7. Prefetch address, equal to two plus the PC value pushed onto the stack. In recovery from sleep mode or software standby mode the read operation is replaced by an internal operation.
8. Start address of the interrupt-handling routine.
9. An internal operation may require between 0 and 3 additional states, depending on the preceding instruction.
10. Only register ER0, ER1, ER4, or ER5 should be used when using the TAS instruction.

## 2.8 Condition Code Modification

This section indicates the effect of each CPU instruction on the condition code. The notation used in the table is defined below.

$$m = \begin{cases} 31 & \text{for longword operands} \\ 15 & \text{for word operands} \\ 7 & \text{for byte operands} \end{cases}$$

$S_i$  The  $i$ -th bit of the source operand

$D_i$  The  $i$ -th bit of the destination operand

$R_i$  The  $i$ -th bit of the result

$D_n$  The specified bit in the destination operand

— Not affected

$\updownarrow$  Modified according to the result of the instruction (see definition)

0 Always cleared to 0

1 Always set to 1

\* Undetermined (no guaranteed value)

Z' Z flag before instruction execution

C' C flag before instruction execution

**Table 2.7 Condition Code Modification**

Instruction	H	N	Z	V	C	Definition
ADD	↑	↑	↑	↑	↑	$H = Sm-4 \cdot Dm-4 + Dm-4 \cdot \overline{RmD4} + Sm-4 \cdot \overline{RmD4}$ $N = Rm$ $Z = \overline{Rm} \cdot \overline{RmD1} \cdot \dots \cdot \overline{R0}$ $V = Sm \cdot Dm \cdot \overline{Rm} + \overline{Sm} \cdot \overline{Dm} \cdot Rm$ $C = Sm \cdot Dm + Dm \cdot \overline{Rm} + Sm \cdot \overline{Rm}$
ADDS	—	—	—	—	—	
ADDX	↑	↑	↑	↑	↑	$H = Sm-4 \cdot Dm-4 + Dm-4 \cdot \overline{RmD4} + Sm-4 \cdot \overline{RmD4}$ $N = Rm$ $Z = Z' \cdot \overline{Rm} \cdot \dots \cdot \overline{R0}$ $V = Sm \cdot Dm \cdot \overline{Rm} + \overline{Sm} \cdot \overline{Dm} \cdot Rm$ $C = Sm \cdot Dm + Dm \cdot \overline{Rm} + Sm \cdot \overline{Rm}$
AND	—	↑	↑	0	—	$N = Rm$ $Z = \overline{Rm} \cdot \overline{RmD1} \cdot \dots \cdot \overline{R0}$
ANDC	↑	↑	↑	↑	↑	Stores the corresponding bits of the result. No flags change when the operand is EXR.
BAND	—	—	—	—	↑	$C = C' \cdot Dn$
Bcc	—	—	—	—	—	
BCLR	—	—	—	—	—	
BIAND	—	—	—	—	↑	$C = C' \cdot \overline{Dn}$
BILD	—	—	—	—	↓	$C = \overline{Dn}$
BIOR	—	—	—	—	↓	$C = C' + \overline{Dn}$
BIST	—	—	—	—	—	
BIXOR	—	—	—	—	↓	$C = C' \cdot Dn + \overline{C'} \cdot \overline{Dn}$
BLD	—	—	—	—	↓	$C = Dn$
BNOT	—	—	—	—	—	
BOR	—	—	—	—	↓	$C = C' + Dn$
BSET	—	—	—	—	—	
BSR	—	—	—	—	—	
BST	—	—	—	—	—	
BTST	—	—	↑	—	—	$Z = \overline{Dn}$
BXOR	—	—	—	—	↓	$C = C' \cdot \overline{Dn} + \overline{C'} \cdot Dn$
CLRMAC*	—	—	—	—	—	
CMP	↑	↑	↑	↑	↑	$H = Sm-4 \cdot \overline{DmD4} + \overline{DmD4} \cdot Rm-4 + Sm-4 \cdot Rm-4$ $N = Rm$ $Z = \overline{Rm} \cdot \overline{RmD1} \cdot \dots \cdot \overline{R0}$ $V = \overline{Sm} \cdot Dm \cdot \overline{Rm} + Sm \cdot \overline{Dm} \cdot Rm$ $C = Sm \cdot \overline{Dm} + \overline{Dm} \cdot Rm + Sm \cdot Rm$

Instruction	H	N	Z	V	C	Definition
DAA	*	↕	↕	*	↕	N = Rm Z = $\overline{Rm} \cdot \overline{RmD1} \cdot \dots \cdot \overline{R0}$ C: decimal arithmetic carry
DAS	*	↕	↕	*	↕	N = Rm Z = $\overline{Rm} \cdot \overline{RmD1} \cdot \dots \cdot \overline{R0}$ C: decimal arithmetic borrow
DEC	—	↕	↕	↕	—	N = Rm Z = $\overline{Rm} \cdot \overline{RmD1} \cdot \dots \cdot \overline{R0}$ V = $Dm \cdot \overline{Rm}$
DIVXS	—	↕	↕	—	—	N = $Sm \cdot \overline{Dm} + \overline{Sm} \cdot Dm$ Z = $\overline{Sm} \cdot \overline{SmD1} \cdot \dots \cdot \overline{S0}$
DIVXU	—	↕	↕	—	—	N = Sm Z = $\overline{Sm} \cdot \overline{SmD1} \cdot \dots \cdot \overline{S0}$
EEPMOV	—	—	—	—	—	
EXTS	—	↕	↕	0	—	N = Rm Z = $\overline{Rm} \cdot \overline{RmD1} \cdot \dots \cdot \overline{R0}$
EXTU	—	0	↕	0	—	Z = $\overline{Rm} \cdot \overline{RmD1} \cdot \dots \cdot \overline{R0}$
INC	—	↕	↕	↕	—	N = Rm Z = $\overline{Rm} \cdot \overline{RmD1} \cdot \dots \cdot \overline{R0}$ V = $\overline{Dm} \cdot Rm$
JMP	—	—	—	—	—	
JSR	—	—	—	—	—	
LDC	↕	↕	↕	↕	↕	Stores the corresponding bits of the result. No flags change when the operand is EXR.
LDM	—	—	—	—	—	
LDMAC*	—	—	—	—	—	
MAC*	—	—	—	—	—	
MOV	—	↕	↕	0	—	N = Rm Z = $\overline{Rm} \cdot \overline{RmD1} \cdot \dots \cdot \overline{R0}$
MOVFPPE	—	↕	↕	0	—	N = Rm Z = $\overline{Rm} \cdot \overline{RmD1} \cdot \dots \cdot \overline{R0}$
MOVTPPE	—	↕	↕	0	—	N = Rm Z = $\overline{Rm} \cdot \overline{RmD1} \cdot \dots \cdot \overline{R0}$
MULXS	—	↕	↕	—	—	N = R2m Z = $\overline{R2m} \cdot \overline{R2mD1} \cdot \dots \cdot \overline{R0}$



Instruction	H	N	Z	V	C	Definition
MULXU	—	—	—	—	—	
NEG	↑	↑	↑	↑	↑	$H = Dm-4 + Rm-4$ $N = Rm$ $Z = \overline{Rm} \cdot \overline{Rm\text{D}1} \cdot \dots \cdot \overline{R0}$ $V = Dm \cdot Rm$ $C = Dm + Rm$
NOP	—	—	—	—	—	
NOT	—	↑	↑	0	—	$N = Rm$ $Z = \overline{Rm} \cdot \overline{Rm\text{D}1} \cdot \dots \cdot \overline{R0}$
OR	—	↑	↑	0	—	$N = Rm$ $Z = \overline{Rm} \cdot \overline{Rm\text{D}1} \cdot \dots \cdot \overline{R0}$
ORC	↑	↑	↑	↑	↑	Stores the corresponding bits of the result. No flags change when the operand is EXR.
POP	—	↑	↑	0	—	$N = Rm$ $Z = \overline{Rm} \cdot \overline{Rm\text{D}1} \cdot \dots \cdot \overline{R0}$
PUSH	—	↑	↑	0	—	$N = Rm$ $Z = \overline{Rm} \cdot \overline{Rm\text{D}1} \cdot \dots \cdot \overline{R0}$
ROTL	—	↑	↑	0	↑	$N = Rm$ $Z = \overline{Rm} \cdot \overline{Rm\text{D}1} \cdot \dots \cdot \overline{R0}$ $C = Dm$ (1-bit shift) or $C = Dm-1$ (2-bit shift)
ROTR	—	↑	↑	0	↑	$N = Rm$ $Z = \overline{Rm} \cdot \overline{Rm\text{D}1} \cdot \dots \cdot \overline{R0}$ $C = D0$ (1-bit shift) or $C = D1$ (2-bit shift)
ROTXL	—	↑	↑	0	↑	$N = Rm$ $Z = \overline{Rm} \cdot \overline{Rm\text{D}1} \cdot \dots \cdot \overline{R0}$ $C = Dm$ (1-bit shift) or $C = Dm-1$ (2-bit shift)
ROTXR	—	↑	↑	0	↑	$N = Rm$ $Z = \overline{Rm} \cdot \overline{Rm\text{D}1} \cdot \dots \cdot \overline{R0}$ $C = D0$ (1-bit shift) or $C = D1$ (2-bit shift)
RTE	↑	↑	↑	↑	↑	Stores the corresponding bits of the result.
RTS	—	—	—	—	—	
SHAL	—	↑	↑	↑	↑	$N = Rm$ $Z = \overline{Rm} \cdot \overline{Rm\text{D}1} \cdot \dots \cdot \overline{R0}$ $V = \overline{Dm \cdot \overline{Dm\text{D}1} + Dm \cdot \overline{Dm\text{D}2}}$ (1-bit shift) $V = \overline{Dm \cdot \overline{Dm\text{D}1} \cdot \overline{Dm\text{D}2} + Dm \cdot \overline{Dm\text{D}1} \cdot \overline{Dm\text{D}2}}$ (2-bit shift) $C = Dm$ (1-bit shift) or $C = Dm-1$ (2-bit shift)

Instruction	H	N	Z	V	C	Definition
SHAR	—	↕	↕	0	↕	N = Rm Z = $\overline{Rm} \cdot \overline{Rm\overline{D1}} \cdot \dots \cdot \overline{R0}$ C = D0 (1-bit shift) or C = D1 (2-bit shift)
SHLL	—	↕	↕	0	↕	N = Rm Z = $\overline{Rm} \cdot \overline{Rm\overline{D1}} \cdot \dots \cdot \overline{R0}$ C = Dm (1-bit shift) or C = Dm-1 (2-bit shift)
SHLR	—	0	↕	0	↕	N = Rm Z = $\overline{Rm} \cdot \overline{Rm\overline{D1}} \cdot \dots \cdot \overline{R0}$ C = D0 (1-bit shift) or C = D1 (2-bit shift)
SLEEP	—	—	—	—	—	
STC	—	—	—	—	—	
STM	—	—	—	—	—	
STMAC*	—	↕	↕	↕	—	N = 1 if MAC instruction resulted in negative value in MAC register Z = 1 if MAC instruction resulted in zero value in MAC register V = 1 if MAC instruction resulted in overflow
SUB	↕	↕	↕	↕	↕	H = $S_{m-4} \cdot \overline{D_{m\overline{D4}}} + \overline{D_{m\overline{D4}}} \cdot R_{m-4} + S_{m-4} \cdot R_{m-4}$ N = Rm Z = $\overline{Rm} \cdot \overline{Rm\overline{D1}} \cdot \dots \cdot \overline{R0}$ V = $\overline{S_m} \cdot D_m \cdot \overline{R_m} + S_m \cdot \overline{D_m} \cdot R_m$ C = $S_m \cdot \overline{D_m} + \overline{D_m} \cdot R_m + S_m \cdot R_m$
SUBS	—	—	—	—	—	
SUBX	↕	↕	↕	↕	↕	H = $S_{m-4} \cdot \overline{D_{m\overline{D4}}} + \overline{D_{m\overline{D4}}} \cdot R_{m-4} + S_{m-4} \cdot R_{m-4}$ N = Rm Z = $Z' \cdot \overline{Rm} \cdot \dots \cdot \overline{R0}$ V = $\overline{S_m} \cdot D_m \cdot \overline{R_m} + S_m \cdot \overline{D_m} \cdot R_m$ C = $S_m \cdot \overline{D_m} + \overline{D_m} \cdot R_m + S_m \cdot R_m$
TAS	—	↕	↕	0	—	N = Dm Z = $\overline{Dm} \cdot \overline{Dm\overline{D1}} \cdot \dots \cdot \overline{D0}$
TRAPA	—	—	—	—	—	
XOR	—	↕	↕	0	—	N = Rm Z = $\overline{Rm} \cdot \overline{Rm\overline{D1}} \cdot \dots \cdot \overline{R0}$
XORC	↕	↕	↕	↕	↕	Stores the corresponding bits of the result. No flags change when the operand is EXR.

Note: \* These instructions are supported by the H8S/2600 CPU only.

# Section 3 Processing States

## 3.1 Overview

The CPU has five main processing states: the reset state, exception handling state, program execution state, bus-released state, and power-down state. Figure 3.1 shows a diagram of the processing states. Figure 3.2 indicates the state transitions.

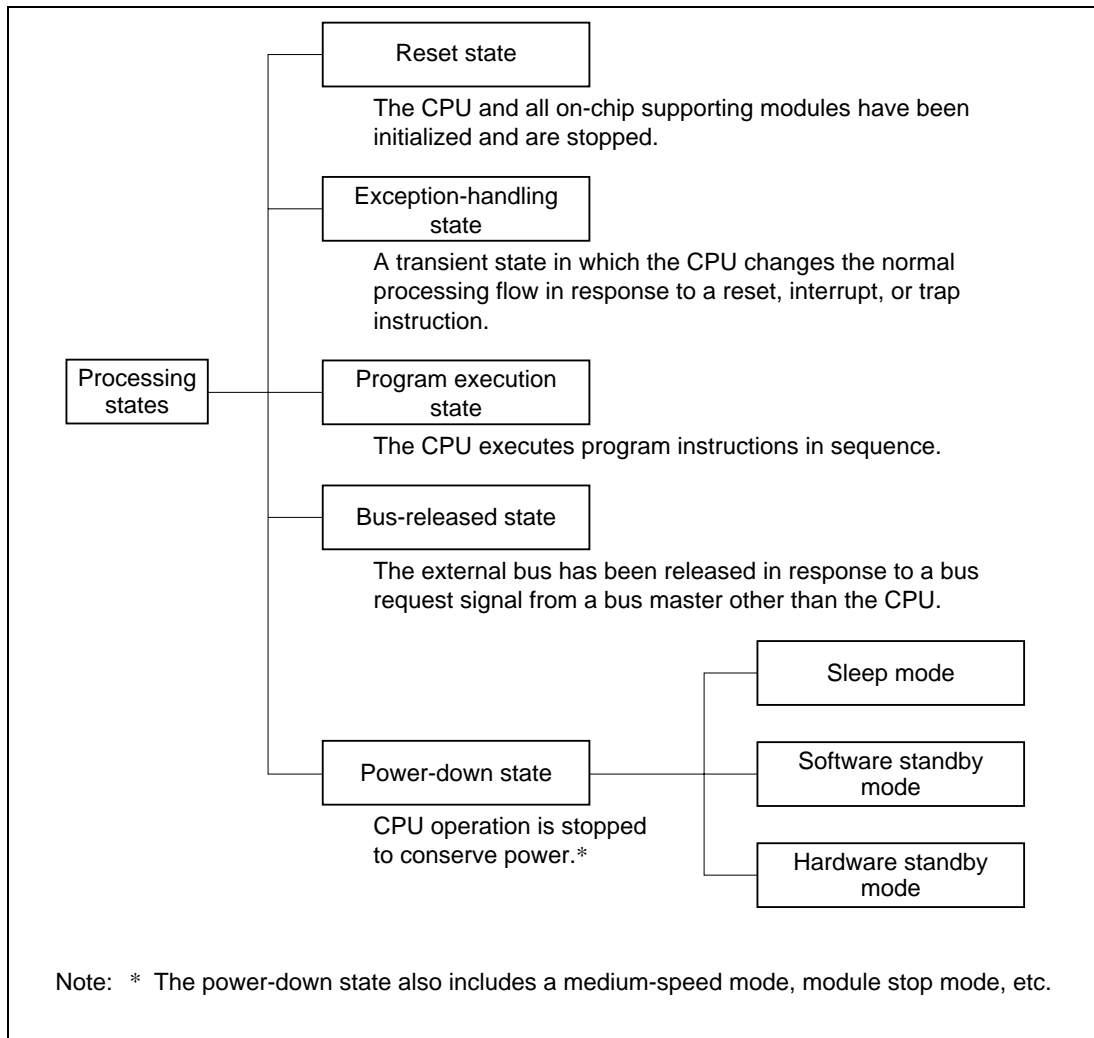

**Figure 3.1 Processing States**

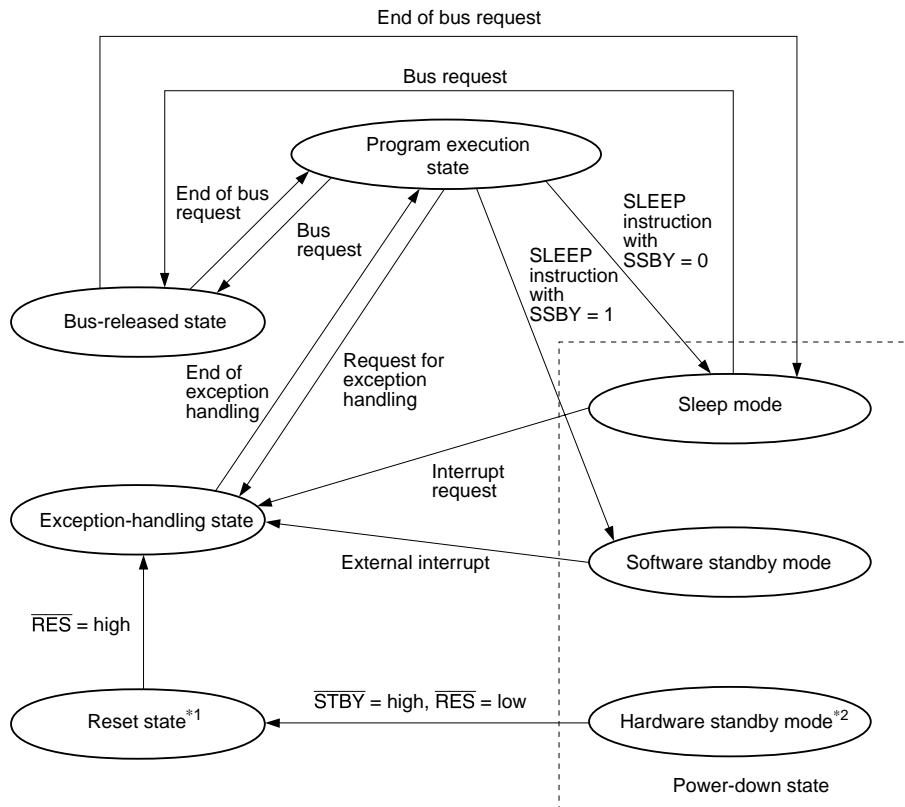

- Notes: 1. From any state except hardware standby mode, a transition to the reset state occurs whenever  $\overline{RES}$  goes low.  
 2. From any state, a transition to hardware standby mode occurs when  $\overline{STBY}$  goes low.

**Figure 3.2 State Transitions**

## 3.2 Reset State

When the  $\overline{RES}$  input goes low all current processing stops and the CPU enters the reset state. Reset exception handling starts when the  $\overline{RES}$  signal changes from low to high.

The reset state can also be entered by a watchdog timer overflow. For details, refer to the relevant microcontroller hardware manual.

## 3.3 Exception-Handling State

The exception-handling state is a transient state that occurs when the CPU alters the normal processing flow due to a reset, interrupt, or trap instruction. The CPU fetches a start address (vector) from the exception vector table and branches to that address.

### 3.3.1 Types of Exception Handling and Their Priority

Exception handling is performed for traces, resets, interrupts, and trap instructions. Table 3.1 indicates the types of exception handling and their priority. Trap instruction exception handling is always accepted, in the program execution state.

Exception handling and the stack structure differ according to the interrupt control mode set in SYSCR.

**Table 3.1 Exception Handling Types and Priority**

Priority	Type of Exception	Detection Timing	Start of Exception Handling
High	Reset	Synchronized with clock	Exception handling starts immediately when RES changes from low to high
	Trace	End of instruction execution or end of exception-handling sequence* <sup>1</sup>	When the trace (T) bit is set to 1, the trace starts at the end of the current instruction or current exception-handling sequence
	Interrupt	End of instruction execution or end of exception-handling sequence* <sup>2</sup>	When an interrupt is requested, exception handling starts at the end of the current instruction or current exception-handling sequence
Low	Trap instruction	When TRAPA instruction is executed	Exception handling starts when a trap (TRAPA) instruction is executed* <sup>3</sup>

- Notes:
1. Traces are enabled only in interrupt control modes 2 and 3. Trace exception-handling is not executed at the end of the RTE instruction.
  2. Interrupts are not detected at the end of the ANDC, ORC, XORC, and LDC instructions, or immediately after reset exception handling.
  3. Trap instruction exception handling is always accepted, in the program execution state.

For details on interrupt control modes, exception sources, and exception handling, refer to the relevant microcontroller hardware manual.

### 3.3.2 Reset Exception Handling

After the  $\overline{\text{RES}}$  pin has gone low and the reset state has been entered, reset exception handling starts when  $\overline{\text{RES}}$  goes high again. When reset exception handling starts the CPU fetches a start address (vector) from the exception vector table and starts program execution from that address. All interrupts, including NMI, are disabled during reset exception handling and after it ends.

### 3.3.3 Trace

Traces are enabled only in interrupt control modes 2 and 3. Trace mode is entered when the T bit of EXR is set to 1. When trace mode is established, trace exception handling starts at the end of each instruction.

At the end of a trace exception-handling sequence, the T bit of EXR is cleared to 0 and trace mode is cleared. Interrupt masks are not affected.

The T bit saved on the stack retains its value of 1, and when the RTE instruction is executed to return from the trace exception-handling routine, trace mode is entered again. Trace exception-handling is not executed at the end of the RTE instruction.

Trace mode is not entered in interrupt control modes 0 and 1, regardless of the state of the T bit.

### 3.3.4 Interrupt Exception Handling and Trap Instruction Exception Handling

When interrupt or trap-instruction exception handling begins, the CPU references the stack pointer (ER7) and pushes the program counter and other control registers onto the stack. Next, the CPU alters the settings of the interrupt mask bits in the control registers. Then the CPU fetches a start address (vector) from the exception vector table and execution branches to that address.

Figure 3.3 shows the stack after exception handling ends, for the case of interrupt mode 1 in advanced mode.

Normal mode

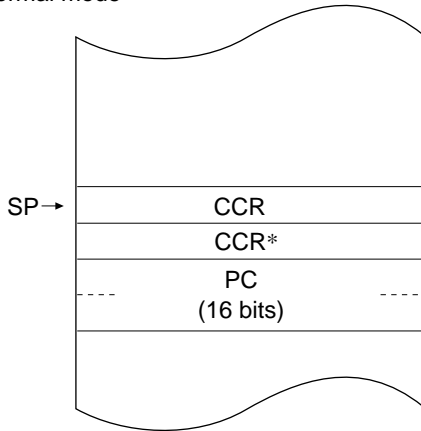

(a) Interrupt control modes 0 & 1

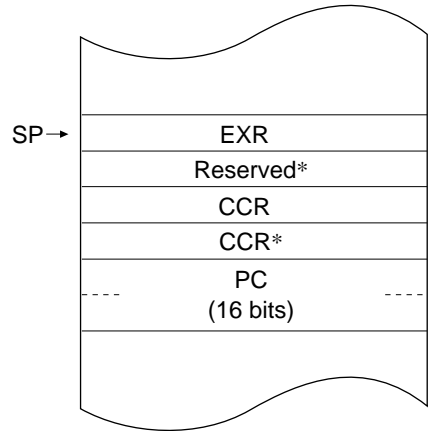

(b) Interrupt control modes 2 & 3

Advanced mode

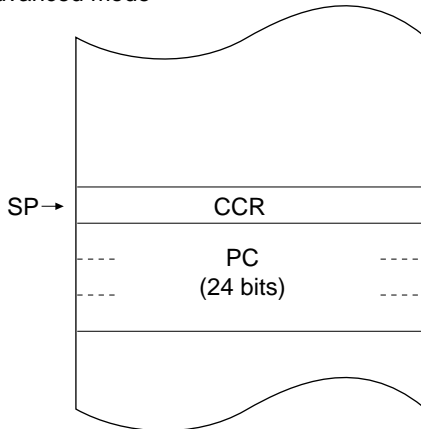

(c) Interrupt control modes 0 & 1

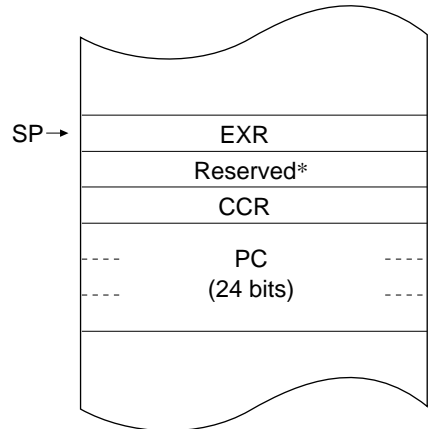

(d) Interrupt control modes 2 & 3

Note: \* Ignored when returning.

Figure 3.3 Stack Structure after Exception Handling (Example)

### 3.4 Program Execution State

In this state the CPU executes program instructions in sequence.

## 3.5 Bus-Released State

This is a state in which the bus has been released in response to a bus request from a bus master other than the CPU. While the bus is released, the CPU halts except for internal operations.

Bus masters other than the CPU may include the direct memory access controller (DMAC) and data transfer controller (DTC).

For further details, refer to the relevant microcontroller hardware manual.

## 3.6 Power-Down State

The power-down state includes both modes in which the CPU stops operating and modes in which the CPU does not stop. There are three modes in which the CPU stops operating: sleep mode, software standby mode, and hardware standby mode. There are also two other power-down modes: medium-speed mode and module stop mode. In medium-speed mode the CPU and other bus masters operate on a medium-speed clock. Module stop mode permits halting of the operation of individual modules, other than the CPU. For details, refer to the relevant microcontroller hardware manual.

### 3.6.1 Sleep Mode

A transition to sleep mode is made if the SLEEP instruction is executed while the software standby bit (SSBY) in the system control register (SYSCR) is cleared to 0. In sleep mode, CPU operations stop immediately after execution of the SLEEP instruction. The contents of CPU registers are retained.

### 3.6.2 Software Standby Mode

A transition to software standby mode is made if the SLEEP instruction is executed while the SSBY bit in SYSCR is set to 1. In software standby mode, the CPU and clock halt and all on-chip operations stop. The on-chip supporting modules are reset, but as long as a specified voltage is supplied, the contents of CPU registers and on-chip RAM are retained. The I/O ports also remain in their existing states.

### 3.6.3 Hardware Standby Mode

A transition to hardware standby mode is made when the  $\overline{\text{STBY}}$  pin goes low. In hardware standby mode, the CPU and clock halt and all on-chip operations stop. The on-chip supporting modules are reset, but as long as a specified voltage is supplied, on-chip RAM contents are retained.



# Section 4 Basic Timing

## 4.1 Overview

The CPU is driven by a system clock, denoted by the symbol  $\phi$ . The period from one rising edge of  $\phi$  to the next is referred to as a “state.” The memory cycle or bus cycle consists of one, two, or three states. Different methods are used to access on-chip memory, on-chip supporting modules, and the external address space. Refer to the relevant microcontroller hardware manual for details.

## 4.2 On-Chip Memory (ROM, RAM)

On-chip memory is accessed in one state. The data bus is 16 bits wide, permitting both byte and word access. Figure 4.1 shows the on-chip memory access cycle. Figure 4.2 shows the pin states.

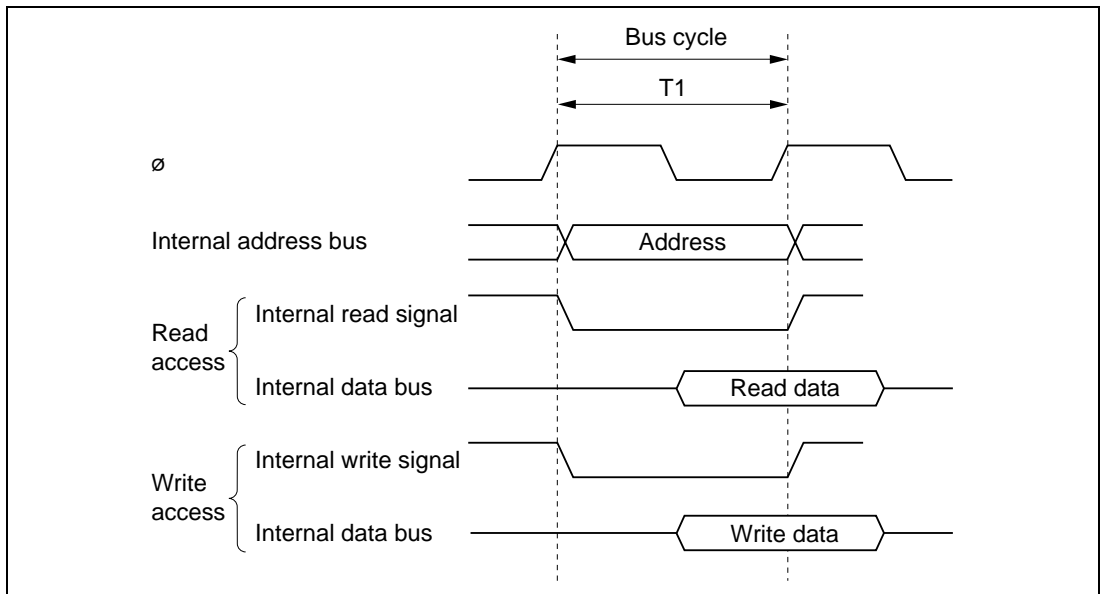
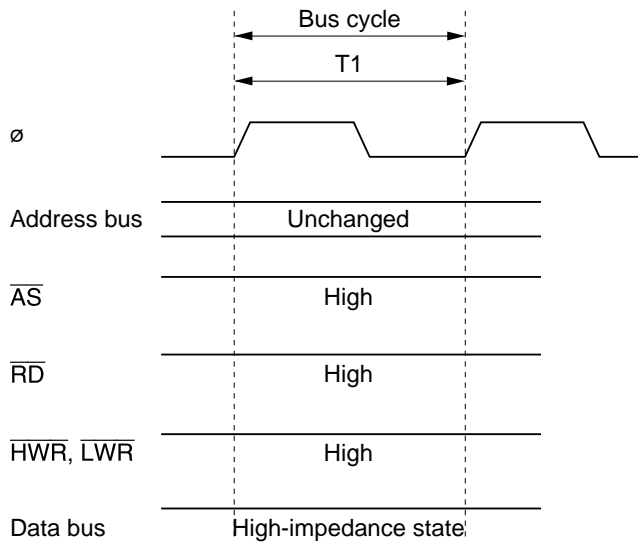

Figure 4.1 On-Chip Memory Access Cycle



**Figure 4.2 Pin States during On-Chip Memory Access**

### 4.3 On-Chip Supporting Module Access Timing

The on-chip supporting modules are accessed in two states. The data bus is either 8 bits or 16 bits wide, depending on the particular on-chip register being accessed. Figure 4.3 shows the access timing for the on-chip supporting modules. Figure 4.4 shows the pin states.

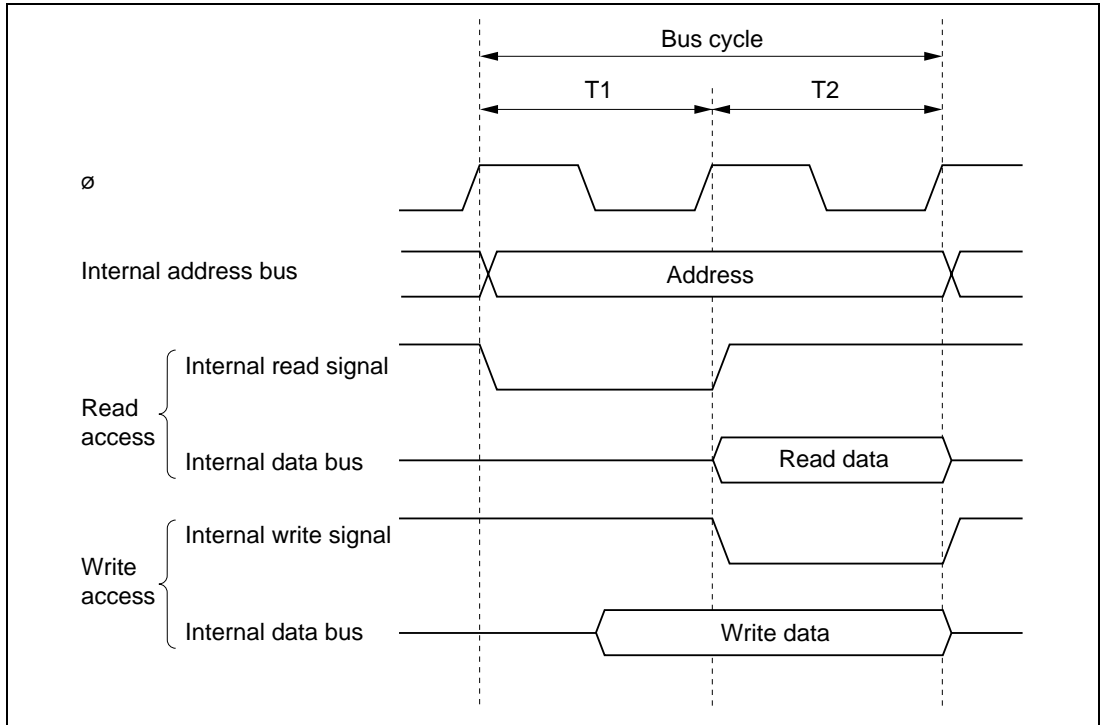
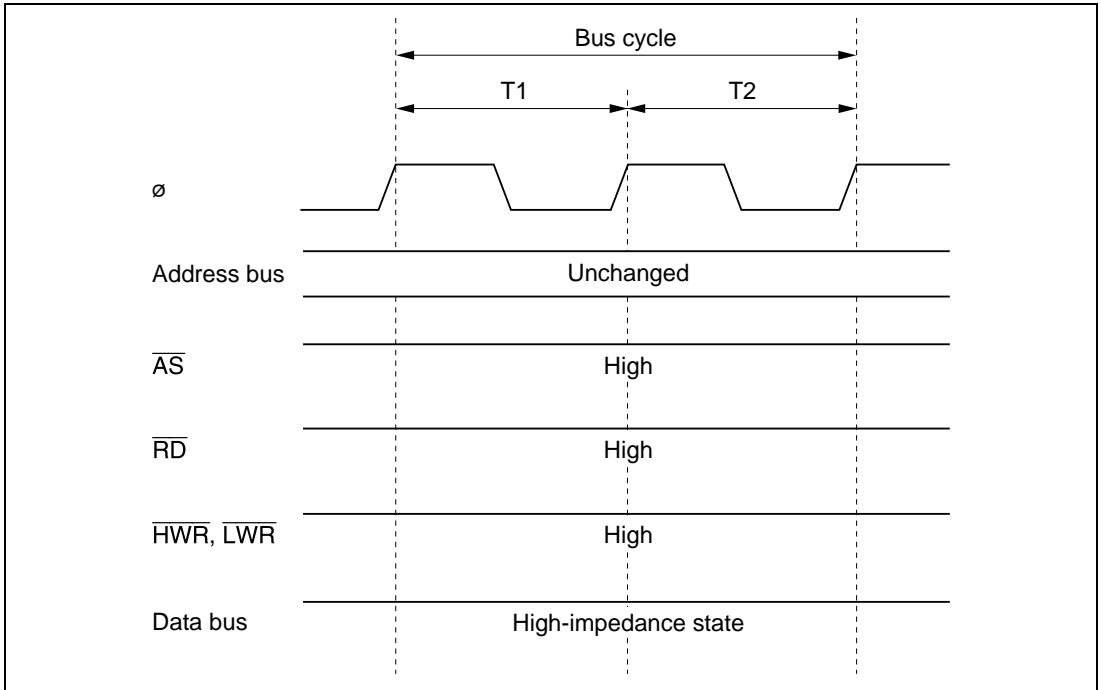

Figure 4.3 On-Chip Supporting Module Access Timing



**Figure 4.4 Pin States during On-Chip Supporting Module Access**

## 4.4 External Address Space Access Timing

The external address space is accessed with an 8-bit or 16-bit data bus width in a two-state or three-state bus cycle. Figure 4.5 shows the read timing for two-state and three-state access. Figure 4.6 shows the write timing for two-state and three-state access. In three-state access, wait states can be inserted. For further details, refer to the relevant microcontroller hardware manual.

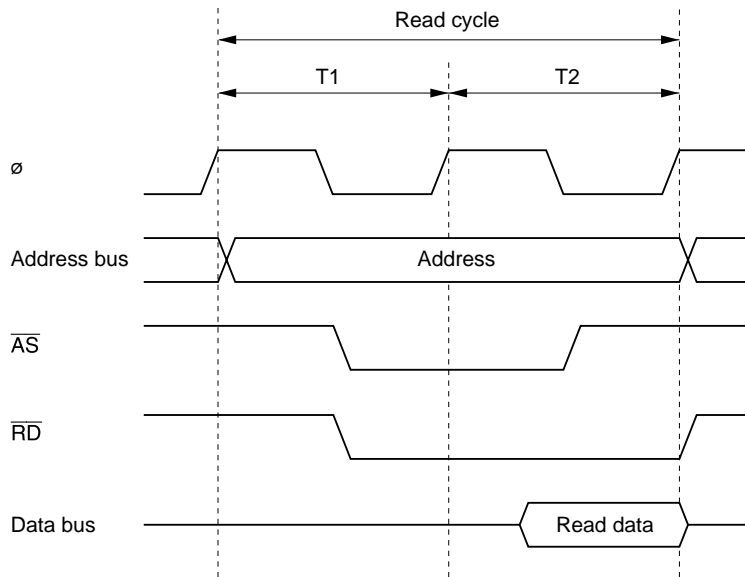

(a) Two-State Access

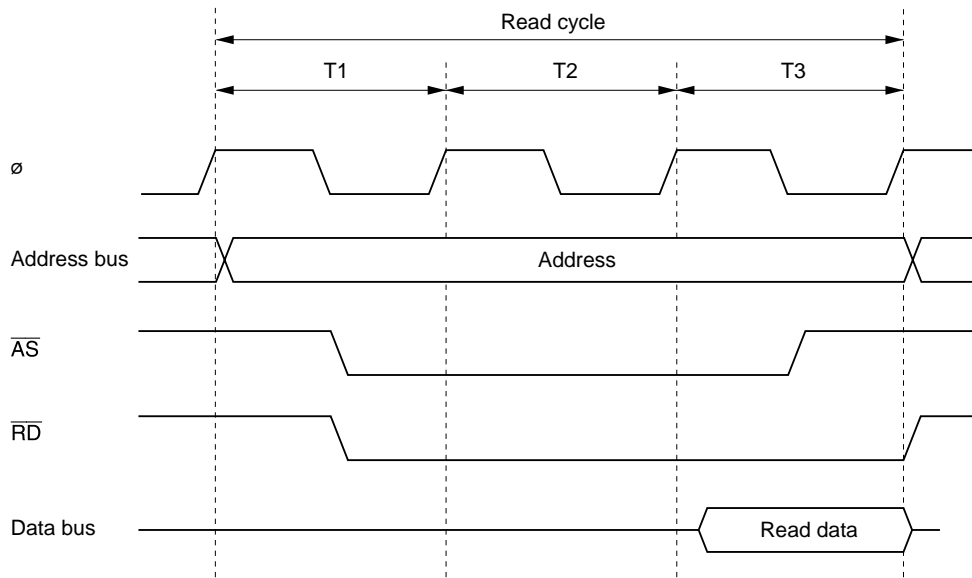

(b) Three-State Access

Figure 4.5 External Device Access Timing (Read Timing)

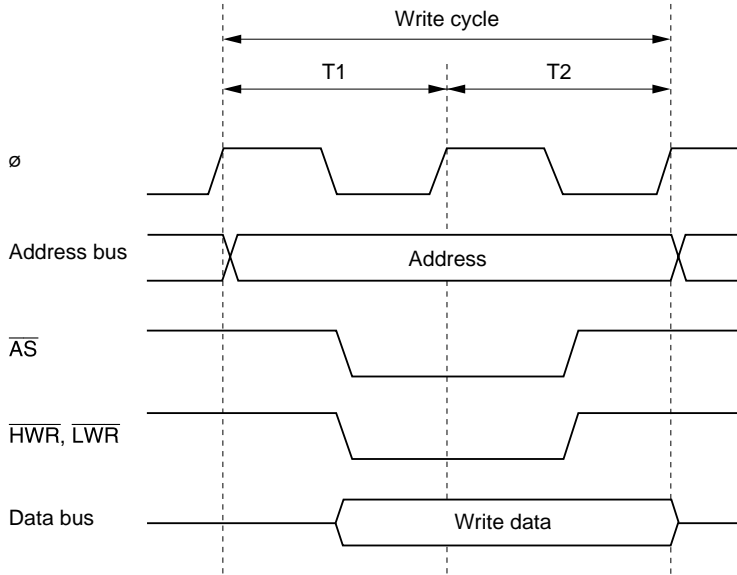

**(a) Two-State Access**

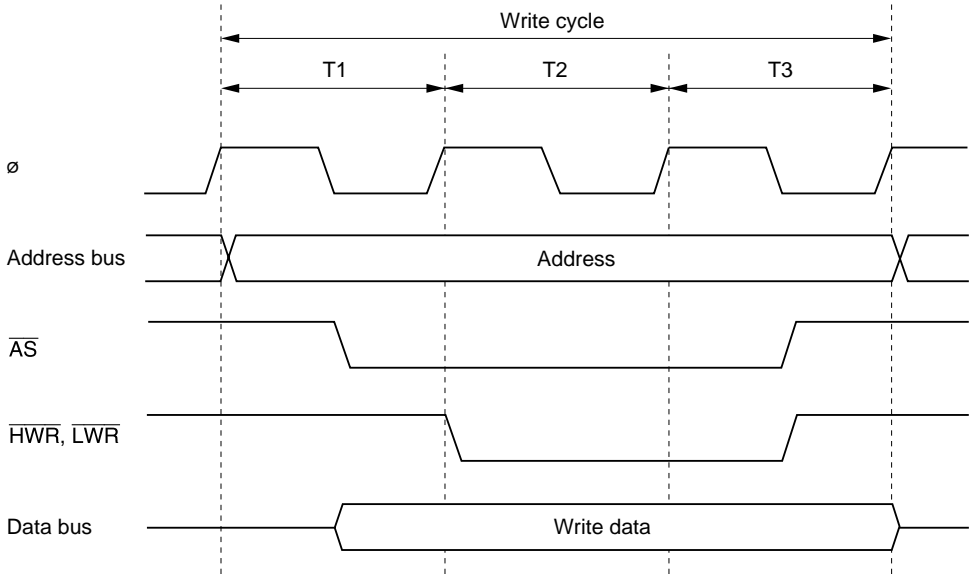

**(b) Three-State Access**

**Figure 4.6 External Device Access Timing (Write Timing)**

---

## **H8S/2600 Series, H8S/2000 Series Programming Manual**

Publication Date: 1st Edition, March 1995

3rd Edition, July 2000

Published by: Electronic Devices Sales & Marketing Group  
Semiconductor & Integrated Circuits  
Hitachi, Ltd.

Edited by: Technical Documentation Group  
Hitachi Kodaira Semiconductor Co., Ltd.

Copyright © Hitachi, Ltd., 1995. All rights reserved. Printed in Japan.