

**APPLICATION NOTE**

**Two-stage wideband HF linear  
amplifier for 400 W PEP using  
BLW96 and BLW50F**

**AN98030**

**Two-stage wideband HF linear amplifier for  
400 W PEP using BLW96 and BLW50F**

**Application note  
AN98030**

---

**CONTENTS**

- 1 PART 1  
SINGLE-STAGE WIDEBAND (1.6 – 30 MHz) LINEAR AMPLIFIER FOR 400 W PEP USING TWO BLW96 TRANSISTORS
- 2 PART 2  
A SINGLE-STAGE WIDEBAND (1.6 – 30 MHz) LINEAR AMPLIFIER FOR 25 W PEP USING BLW50F TRANSISTORS IN
- 3 PART 3  
A TWO-STAGE WIDEBAND H.F. LINEAR AMPLIFIER FOR 400 W PEP USING TWO BLW96 AND BLW50F TRANSISTORS

## Two-stage wideband HF linear amplifier for 400 W PEP using BLW96 and BLW50F

Application note  
AN98030

---

### **SUMMARY**

This report is in three parts, each numbered separately.

Part 1 shows that a wideband power amplifier module providing up to 400 W PEP from 1.6 to 30 MHz can be made using two BLW96 transistors. Operating from a 50 V supply, the IMD at 400 W PEP over the band is better than -26 dB when loaded with a 50  $\Omega$  wideband load.

Part 2 describes a suitable drive amplifier using two BLW50F transistors in class A (at the same supply voltage (50 V)). The IMD of the drive amplifier is better than -40 dB into a 50  $\Omega$  load.

Part 3 describes a complete design in which the driver and main amplifiers are combined using direct inter-stage impedance transformation.

---

# Two-stage wideband HF linear amplifier for 400 W PEP using BLW96 and BLW50F

---

Application note  
AN98030

## 1 PART 1

### SINGLE-STAGE WIDEBAND (1.6 – 30 MHz) LINEAR AMPLIFIER FOR 400 W PEP USING TWO BLW96 TRANSISTORS

#### 1 INTRODUCTION

The design of this amplifier was to exploit the performance of the BLW96 in a wideband circuit to provide up to 400 W PEP from 1.6 to 30 MHz.

#### 2 CIRCUIT DESCRIPTION

Figure 1 shows the circuit diagram; Fig.2a shows the circuit board layout, and Figs 2b and 3 show the component lay-out.

It will be noted that baluns are used in input and output circuits. This improves the balance of the collector currents over the frequency range, offsetting any capacitive unbalance in the impedance matching transformers.

Cross neutralisation has been found to be detrimental with these devices, the practical application of neutralisation results in excessive phase changes and results in higher intermodulation distortion over parts of the band.

The input matching network which was designed with aid of a computer program is primarily intended to provide a constant overall gain with frequency and reasonably constant load impedance to a driver circuit.

In practice, a capacitive centre tap ( $C_4$  and  $C_5$ ) at the secondary of the input impedance matching transformer  $T_1$  is desirable, which is earthed via a  $2.2 \Omega$  resistor.

It is preferable in realising  $C_4$  and  $C_5$ , to employ three capacitors of 470, 470 and 390 pF in parallel for both, leaving the centre connection such that alternative connections of  $R_1$  can be selected, as shown in Fig.1. This technique allows the best compromise to be found for the intermodulation distortion peaks which typically occur between 14 and 20 MHz, and which can be undesirably high at spot frequencies. A separate, temperature compensated, bias control circuit is necessary to give adjustable constant class-AB bias condition in the BLW96 transistors. The bias circuit diagram is shown in Fig.1.

#### 3 DESIGN DETAILS

To obtain the best performance from the amplifier over the complete range 1.6 – 30 MHz, the quality of the matching transformers used is very important as accurate impedance transformation and low losses are essential. Low losses can be achieved by using toroids of 4C6 material. To obtain accurate matching it is essential to make transformers with very low leakage reactance at 30 MHz combined with sufficient primary inductance at 1.6 MHz (Refs 1 and 2).

##### 3.1 The output transformer

The load impedance required by the transistors is  $9.6 \Omega$ , collector to collector. A transformer is required to match to the  $50 \Omega$  load. To handle the expected power of 400 W, the transformer must be wound using two 4C6 cores each of  $36 \times 23 \times 15$  mm. The best results were obtained using two separate transformers, each on one core, and connecting primary and secondary windings in parallel to give an acceptable value of leakage reactance at 30 MHz.

The complete transformer, wound as detailed in the parts list had a secondary reactance ( $50 \Omega$  winding) of  $200 \Omega$  at 1.6 MHz ( $20 \mu\text{H}$ ) and a leakage reactance of  $50 \Omega$  at  $f = 30$  MHz ( $265 \text{ nH}$ ).

##### 3.2 The input transformer

The design impedance of the gain correction network is  $5.55 \Omega$ , so a transformer is required to match the input network to a  $50 \Omega$  drive source.

The required drive input power assuming a minimum gain of 13 dB is about 20 W which requires two 4C6 toroids  $14 \times 9 \times 5$  mm. Again, the best results were obtained by the parallel connection of two transformers each using a separate core.

---

## Two-stage wideband HF linear amplifier for 400 W PEP using BLW96 and BLW50F

---

Application note  
AN98030

The complete transformer, wound as detailed in the parts list, had a primary reactance (50  $\Omega$  winding) of 220  $\Omega$  at 1.6 MHz (22  $\mu$ H) and a leakage reactance of 50  $\Omega$  at 30 MHz (265 nH).

### 3.3 The bias unit

The circuit uses a BD433 as the temperature sensor and a BD203 emitter follower. The unit can supply a maximum bias current of 800 mA, dependent on the value of resistor in the collector of the BD203. The bias unit should be thermally connected to the amplifier by mounting on the heatsink close to the BLW96s. The collector load resistor (three 17 W wire-wound resistors in parallel) can be mounted separately on stand-off insulators at any convenient part of the heatsink.

### 3.4 The centre tapped choke

The collector DC supply to each BLW96 is fed via a centre-tapped coil arrangement which consists of a ferrite aerial rod (4A10 grade or equivalent) and has an inductance of 4.6  $\mu$ H which forms part of the total collector load.

## 4 PERFORMANCE OF THE AMPLIFIER

### 4.1 General

The measured performance of the amplifier i.e. intermodulation distortion, gain and input VSWR is given in Figs 4 to 7. A water-cooled heatsink was used for all measurements, and a wideband 50  $\Omega$  load was used in conjunction with a thermal power measurement system. The PEP was assumed to be twice the RMS power indicated, ignoring the harmonic content of the output signal.

### 4.2 Harmonic output

The amplifier was driven with C.W. signals at specific frequencies to 400, 300 and 200 W. The driving signal had a harmonic content lower than -45 dB. Harmonic component measurements are shown in Table 1.

Two-stage wideband HF linear amplifier for  
400 W PEP using BLW96 and BLW50F

Application note  
AN98030

**Table 1** Harmonic output v. frequency

LOAD POWER (W)	TEST FREQUENCY (MHz)	HARMONIC CONTENT (dB)								
		f <sub>2</sub>	f <sub>3</sub>	f <sub>4</sub>	f <sub>5</sub>	f <sub>6</sub>	f <sub>7</sub>	f <sub>8</sub>	f <sub>9</sub>	f <sub>10</sub>
400	1.6	-31	-20	-37	-34	-39	-44	-43	-46	-52
	3.5	-36	-21	-45	-34	-63	-40	-48	-49	-47
	7	-38	-17	-47	-29	-45	-34	-64	-64	
	10	-45	-15	-45	-29	-50				
	14	-39	-16	-45	-46					
	20	-48	-24	-50	-44					
	28	-44	-41							
300	1.6	-31	-21	-39	-33	-40	-47	-43	-46	-52
	3.5	-36	-23	-45	-32	-65	-42	-48	-52	-49
	7	-40	-22	-52	-30	-48	-38	-65	-64	
	10	-48	-16	-45	-29	-50				
	14	-42	-18	-48	-47					
	20	-42	-25	-50	-46					
	28	-45	-42							
200	1.6	-32	-22	-40	-33	-42	-49	-44	-47	-55
	3.5	-35	-24	-46	-33	-65	-43	-50	-53	-50
	7	-40	-23	-62	-30	-59	-39	-65	-64	
	10	-50	-19	-45	-30	-50				
	14	-44	-19	-47	-47					
	20	-38	-27	-49	-47					
	28	-44	-42							

**4.3 Collector efficiency**

The collector efficiency varies over the band, and as the output matching was designed for 400 W, reduced efficiency is apparent at reduced levels of output. Typical efficiencies are:

**Two-tone signals between 1.6 and 30 MHz**

PEP LOAD (W)	BEST COLLECTOR EFFICIENCY (%)	WORST COLLECTOR EFFICIENCY (%)
400	50	37.7
300	44	32

Taking the worst case and assuming equal sharing and zero circuit losses, each transistor would dissipate 170 W.

---

**Two-stage wideband HF linear amplifier for  
400 W PEP using BLW96 and BLW50F**

---

**Application note  
AN98030**

---

**C.W. signals between 1.6 and 30 MHz**

<b>P LOAD (W)</b>	<b>BEST COLLECTOR EFFICIENCY (%)</b>	<b>WORST COLLECTOR EFFICIENCY (%)</b>
400	65.5	47.5

Taking the worst case and assuming equal sharing and zero circuit losses, each transistor would dissipate 220 W.

The published RF thermal resistance of the BLW96 is 0.65 K/W (junction-heatsink) and the maximum permissible junction temperature is 200 °C. Therefore the maximum possible heatsink temperature for continuous C.W. operation is  $200 - (220 \times 0.65) = 57$  °C.

**5 BIAS ADJUSTMENT**

The zero signal collector currents should be adjusted by the bias potentiometer to  $2 \times 100$  mA when operating from a 50 V supply.

**6 CONCLUSIONS**

- A single stage amplifier using  $2 \times$  BLW96s in class-AB can deliver up to 400 W PEP with intermodulation distortion better than -26 dB over the band 1.6 – 30 MHz.
- Measurements indicate that when used under C.W. conditions at the frequencies where the maximum collector dissipations occurs, the devices should be capable of operation with heatsink temperatures up to 57 °C.

**7 REFERENCES**

1. A.H. Hilbers, 'On The Design of HF Wideband Power Transformers.' CAB Report ECO6907.
2. A.H. Hilbers, 'Design of HF Wideband Transformers Part II.' CAB Report ECO7213.

Two-stage wideband HF linear amplifier for  
400 W PEP using BLW96 and BLW50F

Application note  
AN98030

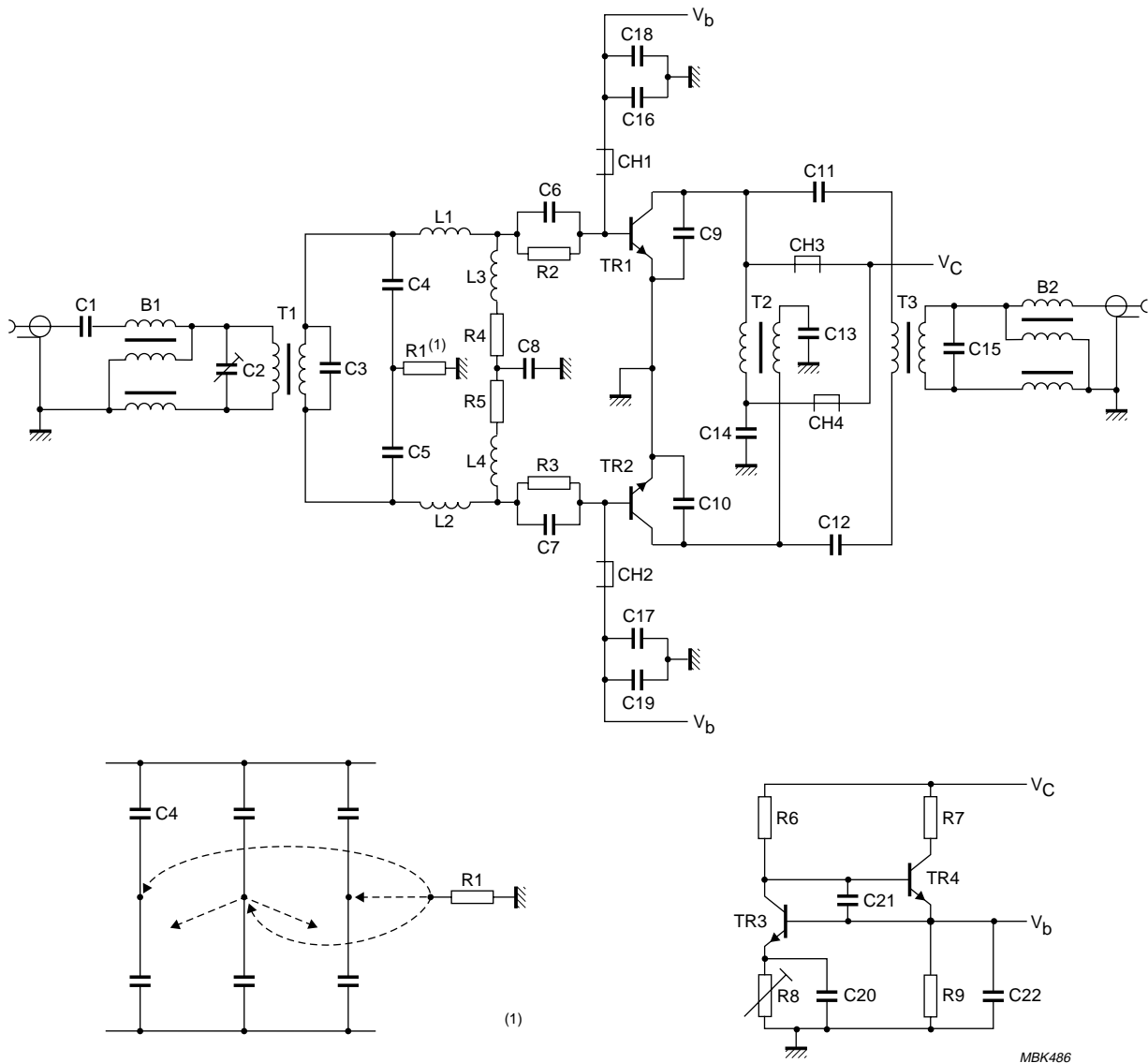

Fig.1 Circuit diagram of BLW96 power amplifier for 1.6 – 30 MHz, 400 W PEP, see Table 2 for parts list.



# Two-stage wideband HF linear amplifier for 400 W PEP using BLW96 and BLW50F

## Application note AN98030

**Table 2** Parts list for Fig.1

<b>Transistors and resistors</b>			
TR1 = TR2	BLW96		
TR3	BD433		
TR4	BD203		
R1	2.2 $\Omega$	CR 37, $\pm 5\%$	2322 212 13228
R2 = R3	18 $\Omega$	PR 37, $\pm 5\%$	2322 191 31809
R4 = R5	2 $\times$ 12 $\Omega$ , in parallel	PR 37, $\pm 5\%$	2322 191 31209
	2 $\times$ 15 $\Omega$ , in parallel	PR 37, $\pm 5\%$	2322 191 31509
R6	1.5 k $\Omega$	PR 37, $\pm 5\%$	2322 191 31502
R7	3 $\times$ 180 $\Omega$ , in parallel	EH 15, $\pm 5\%$	2306 330 03181
R8	3.3 $\Omega$ adjustable	TPW22	2322 011 02338
R9	22 $\Omega$	CR 37, $\pm 5\%$	2322 212 13229
<b>Capacitors</b>			
C1	10 nF	polyester, $\pm 20\%$	2222 342 44103
C2	60 pF	trimmer	2222 809 08003
C3	330 pF, in parallel	polystyrene, $\pm 1\%$	2222 426 43301
	300 pF, in parallel		2222 426 43001
C4 = C5	2 $\times$ 470 pF, in parallel	polystyrene, $\pm 1\%$	2222 426 44701
	1 $\times$ 390 pF, in parallel		2222 426 43901
C6 = C7	2 $\times$ 1000 pF, in parallel	polystyrene, $\pm 1\%$	2222 426 44102
	1 $\times$ 820 pF, in parallel		2222 426 48201
C8	3 $\times$ 100 nF, in parallel	polyester, $\pm 20\%$	2222 342 44104
C9 = C10	2 $\times$ 47 pF, in parallel	ceramic, $\pm 2\%$	2222 650 34479
	2 $\times$ 56 pF, in parallel		2222 650 34569
C11 = C12	5 $\times$ 10 nF, in parallel	polyester, $\pm 20\%$	2222 342 44103
C13 = C14	3 $\times$ 100 nF, in parallel	polyester, $\pm 20\%$	2222 342 44104
C15	33 pF	ceramic, $\pm 2\%$	2222 650 34339
C16 = C17	3.3 $\mu$ F	$\pm 10\%$	2222 344 21335
C18 = C19	220 $\mu$ F	4 V, electrolytic	2222 016 2221
C20 = C21	100 nF	polyester, $\pm 20\%$	2222 342 44104
C22	220 $\mu$ F	10 V, electrolytic	2222 016 4221
<b>Inductors</b>			
L1 = L2	12.9 nH; consists of $\frac{3}{4}$ turn of 1.3 mm Cu wire 5 mm diameter		
L3 = L4	21 nH; consists of 1 turn of 1.3 mm Cu wire 7.5 mm diameter		
Ch1 = Ch2	2.5 turns through 6 hole ferrite bead grade 3B		4312 020 31500
Ch3 = Ch4	3 parallel turns through 6 hole bead grade 3B		4312 020 31500

---

**Two-stage wideband HF linear amplifier for  
400 W PEP using BLW96 and BLW50F**



---

**Application note  
AN98030**

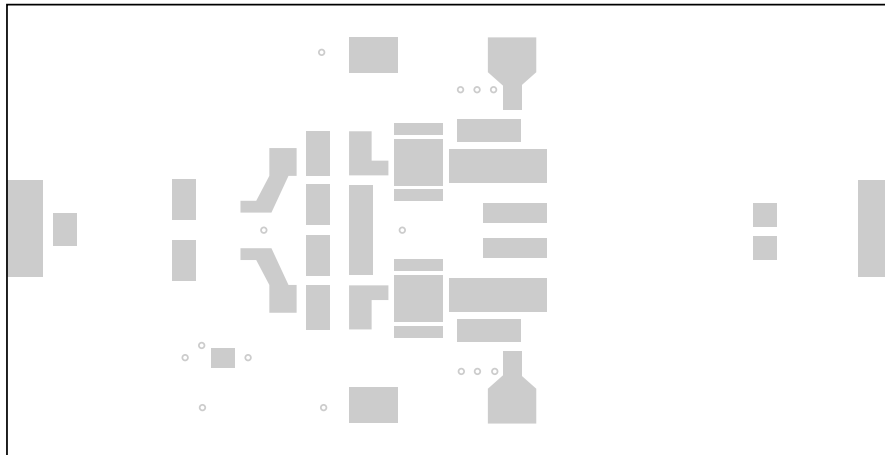

---

<b>Transformers</b>	
T1	Two transformers with parallel connected primary and secondary windings. Each transformer wound on 4C6 toroids 14 × 9 × 15 mm, (4322 020 91020). Primary winding consists of 10 turns of copper tape approximately 1.5 mm wide. Secondary winding consists of 30 turns of 0.45 mm chain enamelled Cu wire. Windings separated by a layer of PTFE tape approximately 0.025 mm thick.
T2	4 turns of 2 × 1.0 mm enamelled Cu wire twisted, on a 50 mm length of 4A10 or equivalent grade aerial rod 10 mm diameter, (4311 020 55390).
T3	Two transformers with parallel connected primary and secondary windings. Each transformer wound on 4C6 toroids 36 × 23 × 15 mm, (4322 020 91090). Primary winding consists of 6 turns copper tape 8.0 mm wide. Secondary winding consists of 14 turns of 4 × 0.5 mm diameter Cu wire in parallel. Windings separated by a layer of PTFE approximately 0.025 mm thick.
B1	11 turns of 50 Ω co-axial cable approximately 3 mm external diameter with PTFE dielectric and 11 turns of 0.5 mm enamelled Cu wire wound on 4C6 toroid 23 × 14 × 7 mm, (4322 020 91070).
B2	8 turns of 50 Ω co-axial cable approximately 4 mm external diameter with PTFE dielectric and 8 turns of 1 mm enamelled Cu wire wound on two 4C6 toroids 36 × 23 × 15 mm, (4322 020 91090).

# Two-stage wideband HF linear amplifier for 400 W PEP using BLW96 and BLW50F

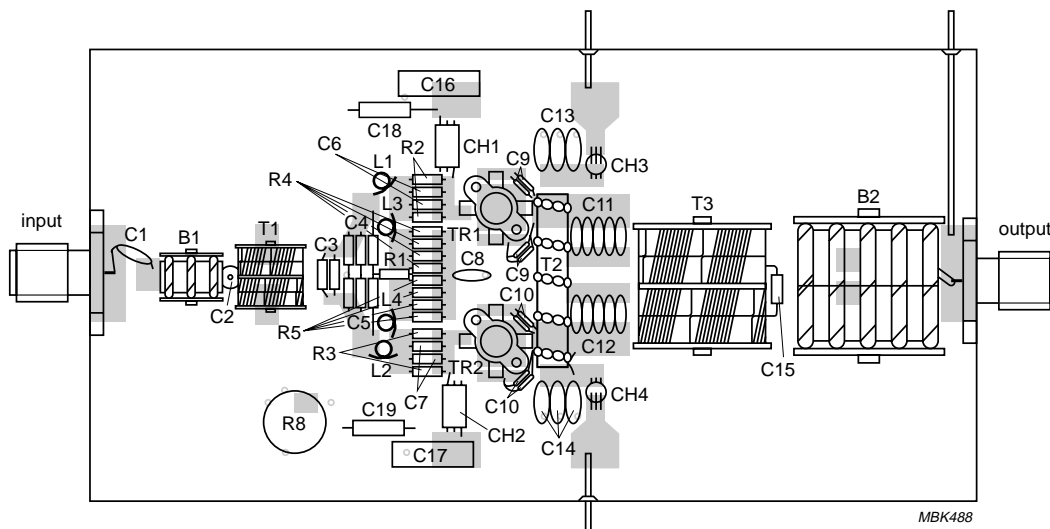

a.



b.

Fig.2 BLW96 power amplifier circuit board (a) and component lay-out (b).

Two-stage wideband HF linear amplifier for  
400 W PEP using BLW96 and BLW50F

Application note  
AN98030

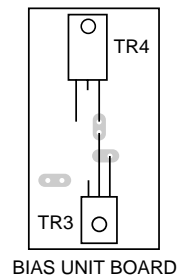
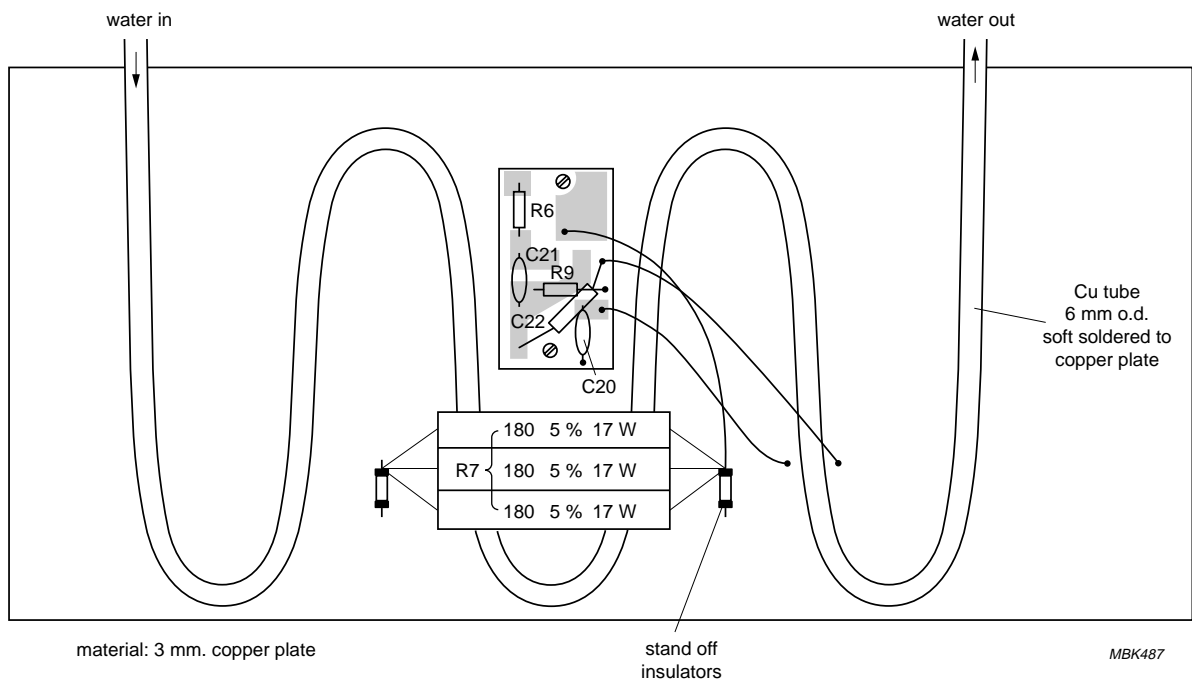

Fig.3 BLW96 power amplifier component lay-out, underside of heatsink.

# Two-stage wideband HF linear amplifier for 400 W PEP using BLW96 and BLW50F

Application note  
AN98030

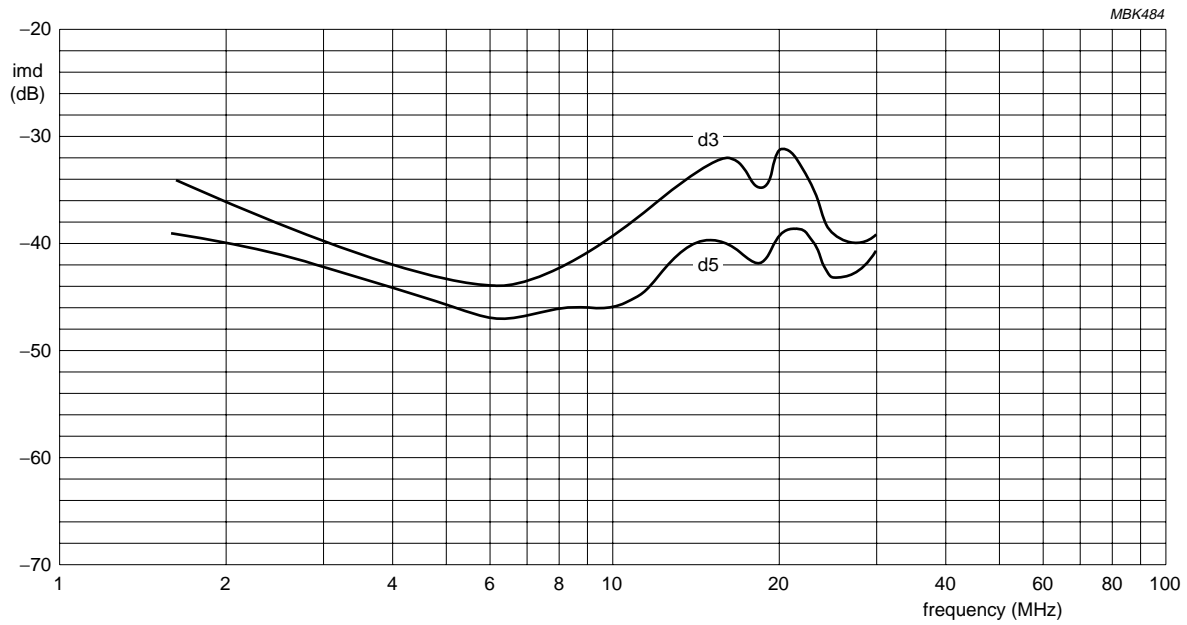

Fig.4 Intermodulation performance of BLW96 amplifier at 200 W PEP.

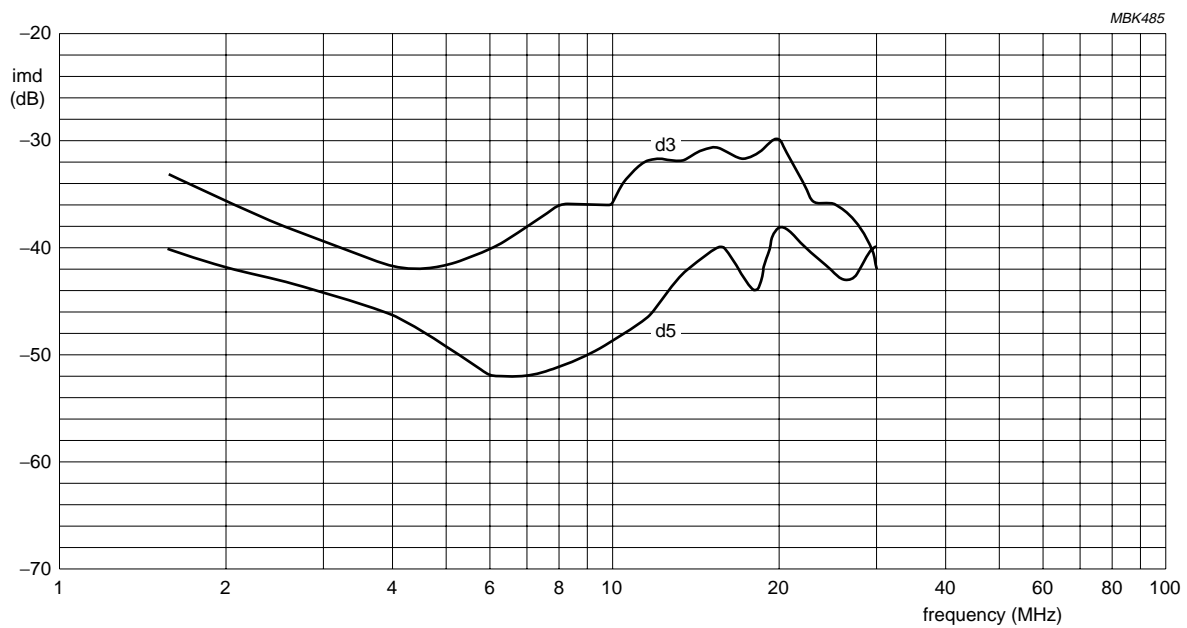

Fig.5 Intermodulation performance of BLW96 amplifier at 300 W PEP.

# Two-stage wideband HF linear amplifier for 400 W PEP using BLW96 and BLW50F

Application note  
AN98030

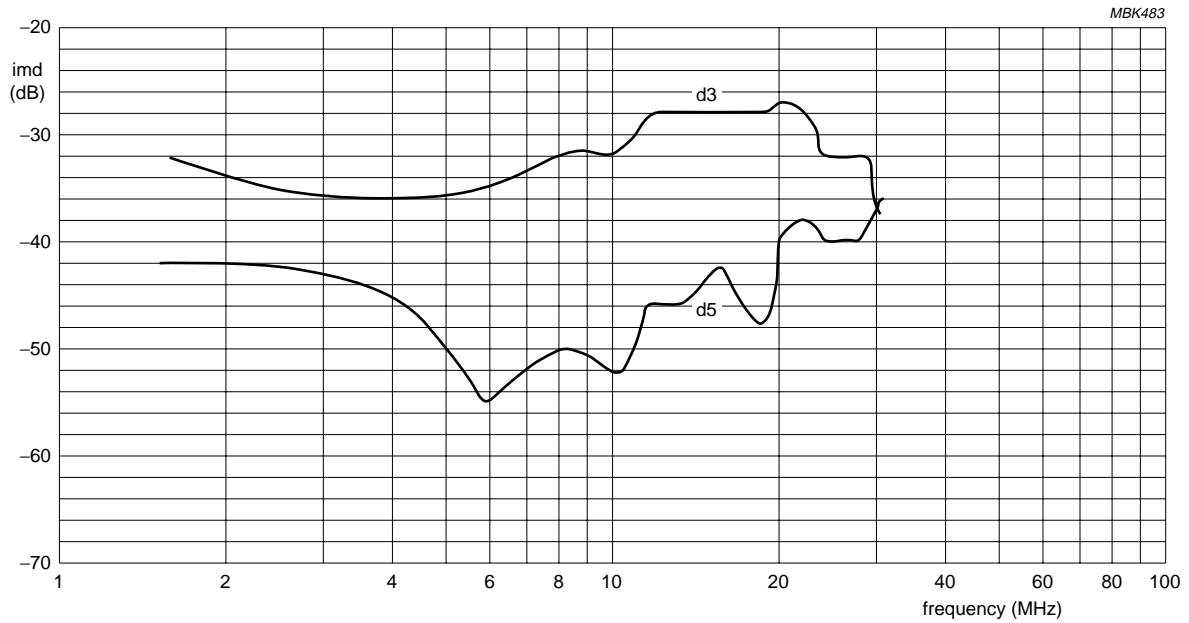

Fig.6 Intermodulation performance of BLW96 amplifier at 400 W PEP.

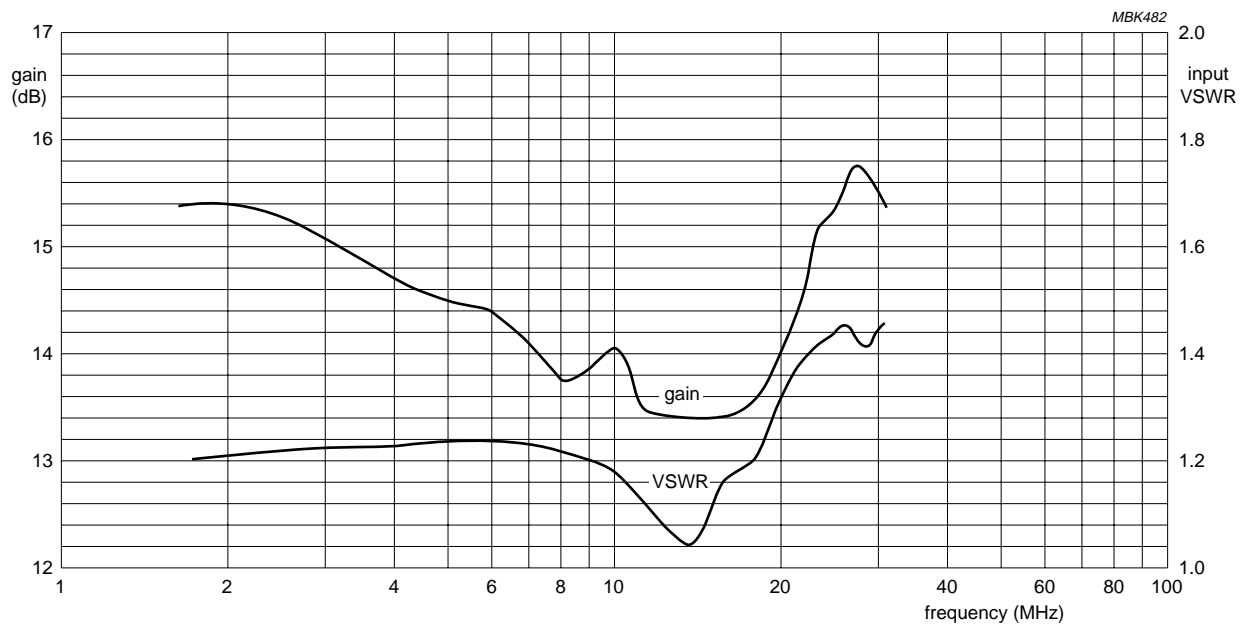

Fig.7 Gain and input VSWR of BLW96 at 400 W C.W.

---

## Two-stage wideband HF linear amplifier for 400 W PEP using BLW96 and BLW50F

---

Application note  
AN98030

### 2 PART 2

#### A SINGLE-STAGE WIDEBAND (1.6 – 30 MHz) LINEAR AMPLIFIER FOR 25 W PEP USING BLW50F TRANSISTORS IN CLASS A

### 1 INTRODUCTION

This amplifier was developed to drive a 400 W linear amplifier using BLW96 transistors in class AB and to provide data for future development of a two stage amplifier for the same power with both driver and p.a. stages working from a nominal 50 V supply.

The driver amplifier described herein was designed to give 25 W PEP into a 50  $\Omega$  load sufficient to drive the amplifier described in Chapter 2. Class A operation is necessary because the required intermodulation distortion of the driver circuit alone should be substantially less than that of the p.a., the driver circuit distortion being somewhat degraded when working into the non-linear input impedance of the p.a. A target figure of intermodulation products  $< -40$  dB over the frequency band 1.6 to 30 MHz was therefore required.

As with the BLW96 p.a., 50  $\Omega$  input and output impedances were assumed initially, but direct inter-stage impedance matching is used in the two stage amplifier which will be reported subsequently.

### 2 GENERAL CIRCUIT DESCRIPTION

The circuit diagram of the amplifier is given in Fig.8, and follows conventional class-A push-pull linear HF amplifier design practice.

Some shunt and series feedback is applied: the shunt feedback resistors are also used to determine bias conditions.

The design and construction of the broadband input and output impedance matching transformers is critical in overall amplifier performance.

Details of these and other construction features are given in Chapter 3.

### 3 DESIGN AND CONSTRUCTION

#### 3.1 Bias condition

In the design of linear class-A amplifiers, in order to arrive at the best intermodulation performance, a suitable starting point is to assume maximum bias current and voltage permitted by the maximum anticipated heatsink temperature.

In this design, therefore, a practical maximum operating heatsink temperature of 70 °C was assumed. At this heatsink temperature, the practical bias conditions for the BLW50F of  $V_{CE} = 44$  V,  $I_C = 1$  A are permissible.

Note that the BLW96 amplifier of Part 1 shows a worst case gain of about 13.5 dB and a worst case VSWR of about 1.45 (these two conditions do not occur at the same frequency however). But, conservatively, we may say that a suitable driver should be capable of about 18.7 W in a 50  $\Omega$  load.

In addition, if this power (18.7 W) is to be available at intermodulation products  $d_3, d_5, < -40$  dB, experience has shown that the maximum available power from the amplifier (class A) into a linear resistive load should approach 35 W, at which power intermodulation products will of course exceed  $-40$  dB.

Further, with the circuit configuration chosen (Fig.8), it will be seen that appreciable power is dissipated in the shunt feedback resistors.

We expect about 15% of the available power will be so dissipated; therefore the maximum available power requirement becomes about 40 W from the transistors.

The projected initial bias conditions,  $V_{CE} = 44$  V,  $I_C = 1$  A correspond to a collector dissipation of 44 W per transistor. Under class-A operation, the maximum output power would then be 22 W per transistor, 44 W total.

## Two-stage wideband HF linear amplifier for 400 W PEP using BLW96 and BLW50F

Application note  
AN98030

There is therefore some margin compared with the estimated capability requirement of 35 W and this is reasonable, in part because some further degradation of intermodulation performance may be expected when directly driving into the somewhat non-linear input impedance of the p.a., instead of the linear, non reactive design load (50  $\Omega$ ).

Having chosen  $V_{CE} = 44$  V, a further voltage drop of 2 V may be assumed across the external emitter resistor for bias stabilisation.

### 3.2 Components and lay-out

Figure 9 gives details of the circuit board and component lay-out. The parts list in Table 3 includes details of wound components including the two wideband matching transformers.

A suitable heatsink must be provided, sufficient to limit the junction temperature to <200 °C under DC (bias) conditions.

The total current required at 46 V is about 2.25 A, which includes base bias current flowing in the feedback resistors.

The total dissipation of the BLW50F transistors is, however approximately  $44 \times 2 = 88$  W.

The feedback resistors and external emitter resistors together dissipate a further 14 W approximately.

If these resistors are mounted so that they do not contribute to the heatsink surface temperature close to the transistors, then the required heatsink thermal resistance,  $\theta_{h-amb}$ , which determines a heatsink temperature of 70 °C in a 25 °C

laboratory ambient, for example is given by:  $\theta_{h-amb} \leq \frac{70 - 25}{88}$

i.e. <0.51 °C/W.

To obtain the best compromise between input VSWR and gain, particularly between 26 and 30 MHz,  $C_2$  is made adjustable; this accommodates the inevitable spread of leakage reactance of the input transformer  $T_1$ .

Similarly, to allow for leakage reactance spreads in  $T_2$ ,  $C_3$  is also made adjustable.

## 4 AMPLIFIER PERFORMANCE

Figures 10 and 11 show the measured amplifier performance.

Figure 11 shows 3rd and 5th order intermodulation products relative to the amplitude of each tone (6.25 W) under standard 2-tone drive conditions.

Figure 10 shows amplifier gain and input VSWR under single tone drive at  $P_{load} = 25$  W.

Note that  $d_3$  is substantially < -40 dB over the frequency range of interest; the minimum gain and worst case VSWR are 15.7 dB, 1.36 respectively, both occurring at the lower frequencies.

## 5 CONCLUSIONS

A wideband linear HF amplifier has been designed and constructed, using BLW50F transistors in class A which can give up to 25 W PEP over the band 1.6 to 30 MHz with 3rd and 5th order intermodulation better than -40 dB between 2 and 28 MHz.

Amplifier gain and input VSWR are better than 15.7 dB and 1.4:1 respectively over the frequency range. The amplifier should be suitable to drive a further linear amplifier using BLW96s in class AB to 400 W PEP.



Two-stage wideband HF linear amplifier for  
400 W PEP using BLW96 and BLW50F

Application note  
AN98030

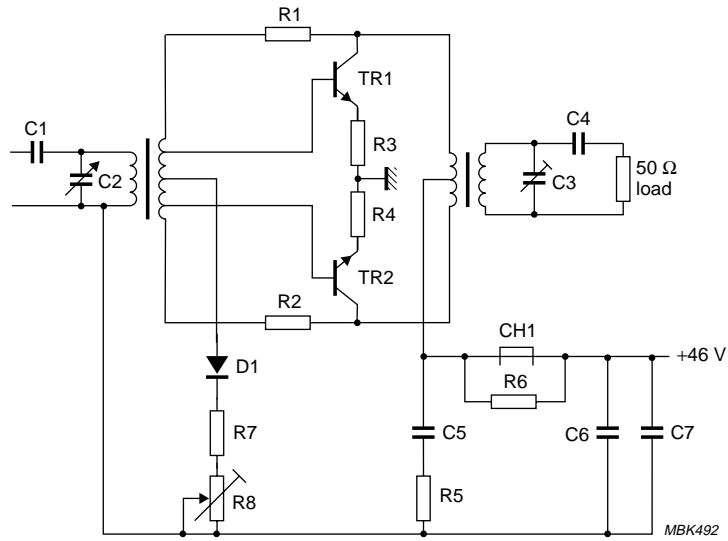

D1 = BY206;  
TR1, TR2 = BLW50F.

Fig.8 Circuit diagram of 25 W linear amplifier.

## Two-stage wideband HF linear amplifier for 400 W PEP using BLW96 and BLW50F

Application note  
AN98030

**Table 3** Parts list for Fig.8

<b>Resistors</b>			
R1 = R2	2 × 200 Ω, in series	PR52, ±5%	2322 192 32001
R3 = R4	5 × 12 Ω, in parallel	CR25, ±5%	2322 211 13129
R5	6.8 Ω	CR25, ±5%	2322 211 13688
R6	22 Ω	CR37, ±5%	2322 211 13229
R7	15 Ω	CR25, ±5%	2322 211 13159
R8	3.3 Ω, adjustable	TPW22	2322 011 02338
<b>Capacitors</b>			
C1 = C4	10 nF	polyester, ±20%	2222 352 44103
C2 = C3	60 pF	trimmers	2222 809 08003
C5	22 nF	polyester, ±20%	2222 352 44223
C6 = C7	2 × 47 nF, in parallel	polyester, ±20%	2222 352 44473
<b>Transformers</b>			
T1	1 : 1.5 turns ratio, wound on twin hole bead Philips grade 4B1, (4312 020 31525). Primary 4 turns of 2 × 0.45 mm enamelled Cu wire in parallel, tapped at centre and 2 × 1 turn from centre.		
T2	1 : 1.4 turns ratio, wound on a Philips 4C6 toroid 23 × 14 × 7 mm, (4322 020 91070). Primary 22 turns of 2 × 0.45 mm enamelled Cu wire centre tapped. Secondary 16 turns of copper tape approx. 1.5 mm wide. Primary wound on top of secondary winding and insulated by PTFE tape approximately 0.025 mm thick.		
Ch1	2.5 turns on 6 hole bead grade 3B, (4312 020 31500).		

Two-stage wideband HF linear amplifier for  
400 W PEP using BLW96 and BLW50F

Application note  
AN98030

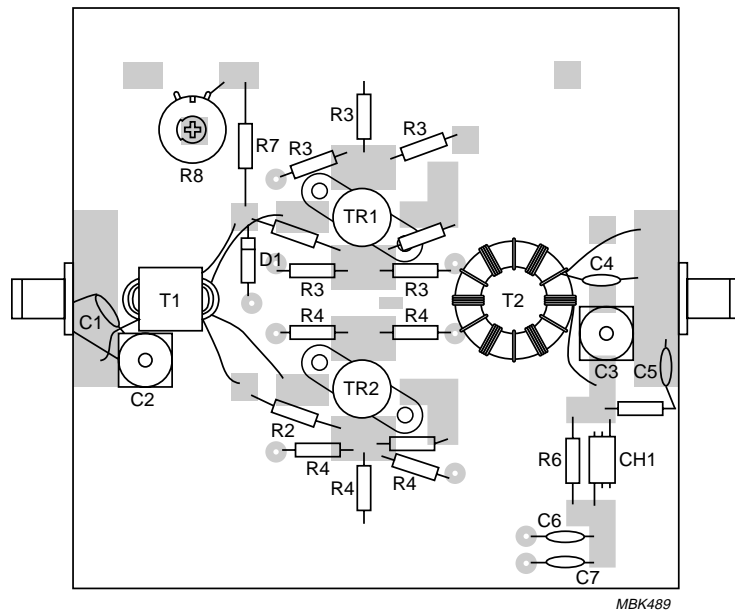
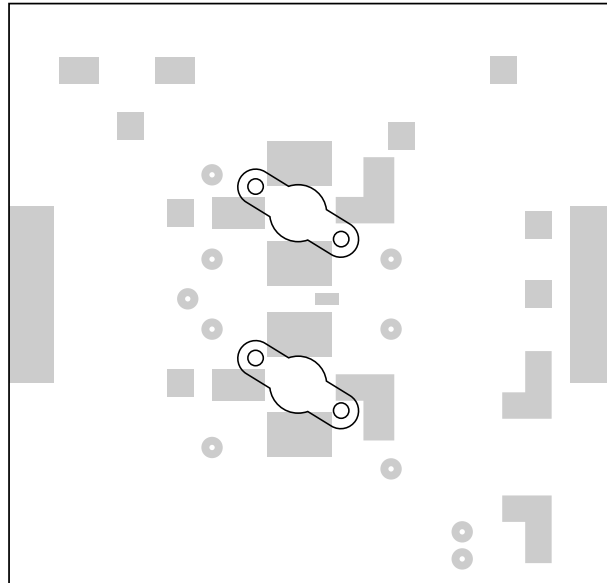

MBK489

Fig.9 Printed circuit board and lay-out.

Two-stage wideband HF linear amplifier for  
400 W PEP using BLW96 and BLW50F

Application note  
AN98030

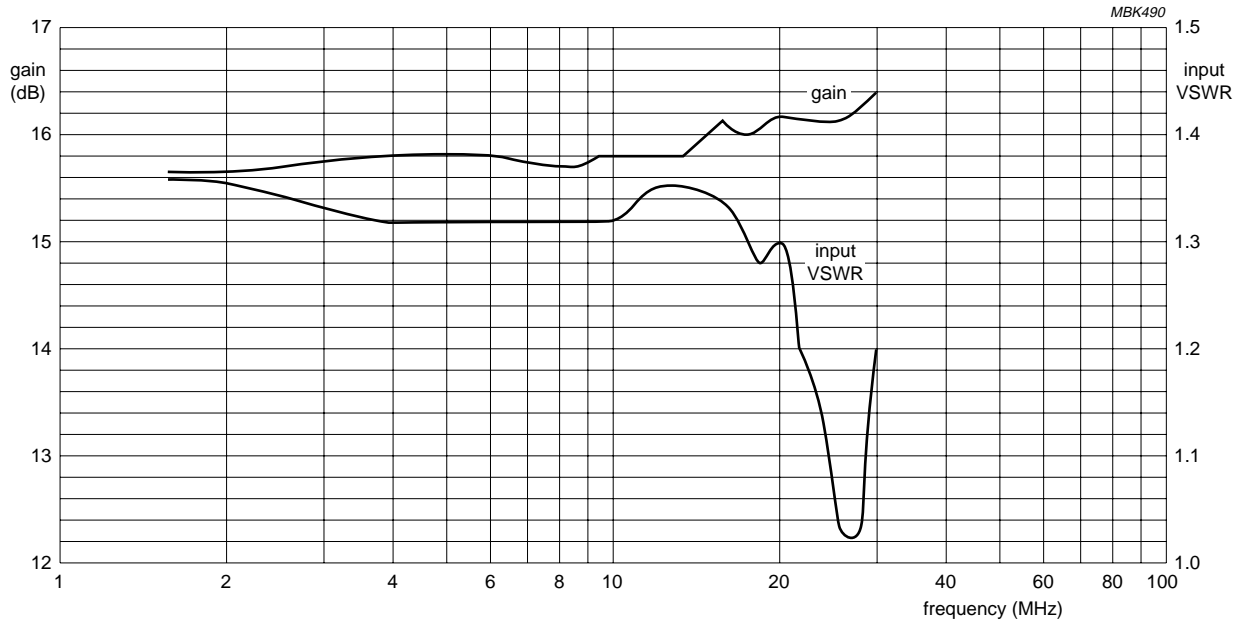

Fig.10 BLW50F linear amplifier gain and input VSWR versus frequency.

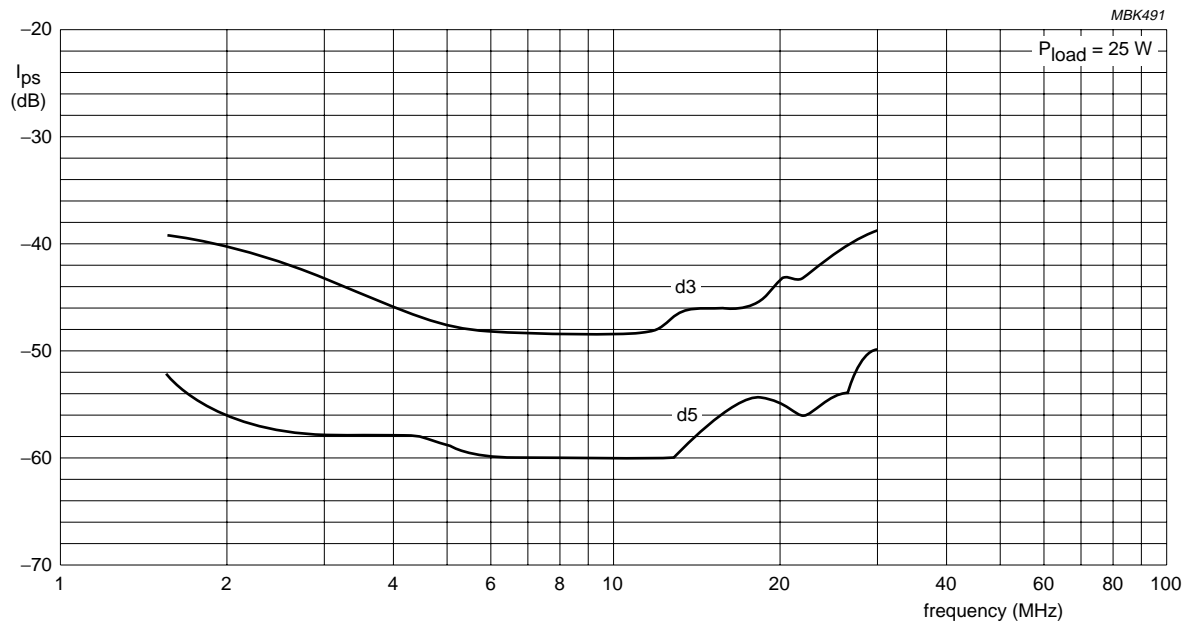

Fig.11 BLW50F linear amplifier-intermodulation products versus frequency.

---

## Two-stage wideband HF linear amplifier for 400 W PEP using BLW96 and BLW50F

---

Application note  
AN98030

### 3 PART 3

#### A TWO-STAGE WIDEBAND H.F. LINEAR AMPLIFIER FOR 400 W PEP USING TWO BLW96 AND BLW50F TRANSISTORS

### 1 INTRODUCTION

It has been shown in Part 1 that two BLW96 transistors in a wideband class-AB push-pull amplifier can give 400 W PEP under two-tone drive with intermodulation products  $< -26$  dB in the band 1.6 – 30 MHz.

Part 2 described a suitable drive amplifier using two BLW50F transistors in class-A at the same supply voltage (50 V nominal). The intermodulation performance of the drive amplifier is  $< -40$  dB into a 50  $\Omega$  load.

The two amplifiers have been combined using direct inter-stage impedance transformation and the overall design is described here in Part 3.

### 2 CIRCUIT DESCRIPTION

The circuit diagram of the complete amplifier is shown in Fig.12.

Standard design practice for the individual BLW96 and BLW50F push-pull linear amplifiers has been closely followed. The differences are:

1. Direct impedance matching between the driver stage output (100  $\Omega$ ) and the p.a. input (5.5  $\Omega$ ).
2. Replacement of adjustable capacitors by fixed-value capacitors, because it is considered impractical to have the complication of adjustments in a two-stage circuit.  
The fixed capacitors are chosen to compensate for leakage reactance of critical transformers towards the higher frequency limit of the band, assuming good winding and mounting technique.
3. Omission of the balun and adjustable centre-tap arrangement in the p.a. input circuits, which are unnecessary with balance provided by a push-pull driver.

### 3 CONSTRUCTIONAL DETAILS

Figure 14 shows the printed circuit board and component layout.

Figure 15 shows the general arrangement of a water-cooled copper heatsink on the underside of which the temperature compensated p.a. bias unit is mounted.

The parts list (Table 5) includes winding instructions and inductors and transformers.

## Two-stage wideband HF linear amplifier for 400 W PEP using BLW96 and BLW50F

Application note  
AN98030

### 4 AMPLIFIER PERFORMANCE

The separate performance of the basic driver and p.a. circuits with 50  $\Omega$  terminations is summarised below

	DRIVER	P.A.
<b>Bias</b>		
$V_{CE}$	44 V	50 V
$I_C$	$2 \times 1$ A	$2 \times 100$ mA (zero signal)
<b>Single tone 1.6 – 30 MHz</b>		
$P_L$	25 W	400 W
Gain		
(mid band)	15.8 dB	13.4 dB
(min., max.)	15.7 dB, 16.4 dB	13.4 dB, 15.8 dB
Input VSWR		
(mid band)	1.35 : 1	1.1 : 1
(max)	1.36 : 1	1.45 : 1
<b>Two tone 1.6 – 30 MHz</b>		
$P_L$ (PEP)	25 W	400 W
Efficiency		37.7% (min)
3rd order intermodulation		
(mid band)	-46 dB	-28 dB
(max)	-39 dB	-27 dB

#### 4.1 GAIN, VSWR and INTERMODULATION

The overall performance of the two stage amplifier is shown in Figs 16 to 20.

Figure 16 shows gain and input VSWR under single tone drive with 50 V supply and  $P_{load} = 400$  W. Minimum gain and VSWR are seen to be 25 dB and 2 : 1 respectively. Figures 17 to 19 show 3rd and 5th order intermodulation under two tone drive conditions with 50 V supply and  $P_{load}$  200, 300 and 400 W PEP.

It is seen that at 400 W PEP,  $d_3 < -26$  dB, and at 300 W PEP,  $d_3 < -30$  dB.

In addition, Fig.20 shows intermodulation performance at 300 W PEP, but with 45 V supply. It is seen that  $d_3$  is still  $< -30$  dB.

#### 4.2 Harmonic content

The amplifier was driven to 400 W C.W. and the amplitude of the harmonics measured relative to the fundamental signal in the wideband load.

---

 Two-stage wideband HF linear amplifier for  
 400 W PEP using BLW96 and BLW50F
 

---

 Application note  
 AN98030
 

---

Table 4

TEST FREQUENCY (MHz)	f <sub>2</sub> (dB)	f <sub>3</sub> (dB)	f <sub>4</sub> (dB)	f <sub>5</sub> (dB)	f <sub>6</sub> (dB)	f <sub>7</sub> (dB)	f <sub>8</sub> (dB)	f <sub>9</sub> (dB)	f <sub>10</sub> (dB)
1.6	-46	-19	-56	-34	-48	-48	-50	-45	-59
3.5	-45	-19	-50	-33	-58	-44	-56	-45	-60
7	-54	-18	-50	-29	-48	-40			
10	-48	-17	-45	-32	-55	-50			
14	-43	-16	-50	-44					
20	-34	-25							
28	-40	-45							

## 5 CONCLUSION

A wideband linear HF amplifier has been designed using BLW96 output and BLW50F driver transistors. The overall amplifier gain is in the range 25 – 29 dB over the band 1.6 – 30 MHz and the input VSWR is less than 2:1.

When operated at 400 W PEP, the (2-tone) intermodulation products are < -26 dB.

An intermodulation product of < -30 dB may be obtained at 300 W PEP even with the supply rail reduced to 45 V.

Two-stage wideband HF linear amplifier for  
400 W PEP using BLW96 and BLW50F

Application note  
AN98030

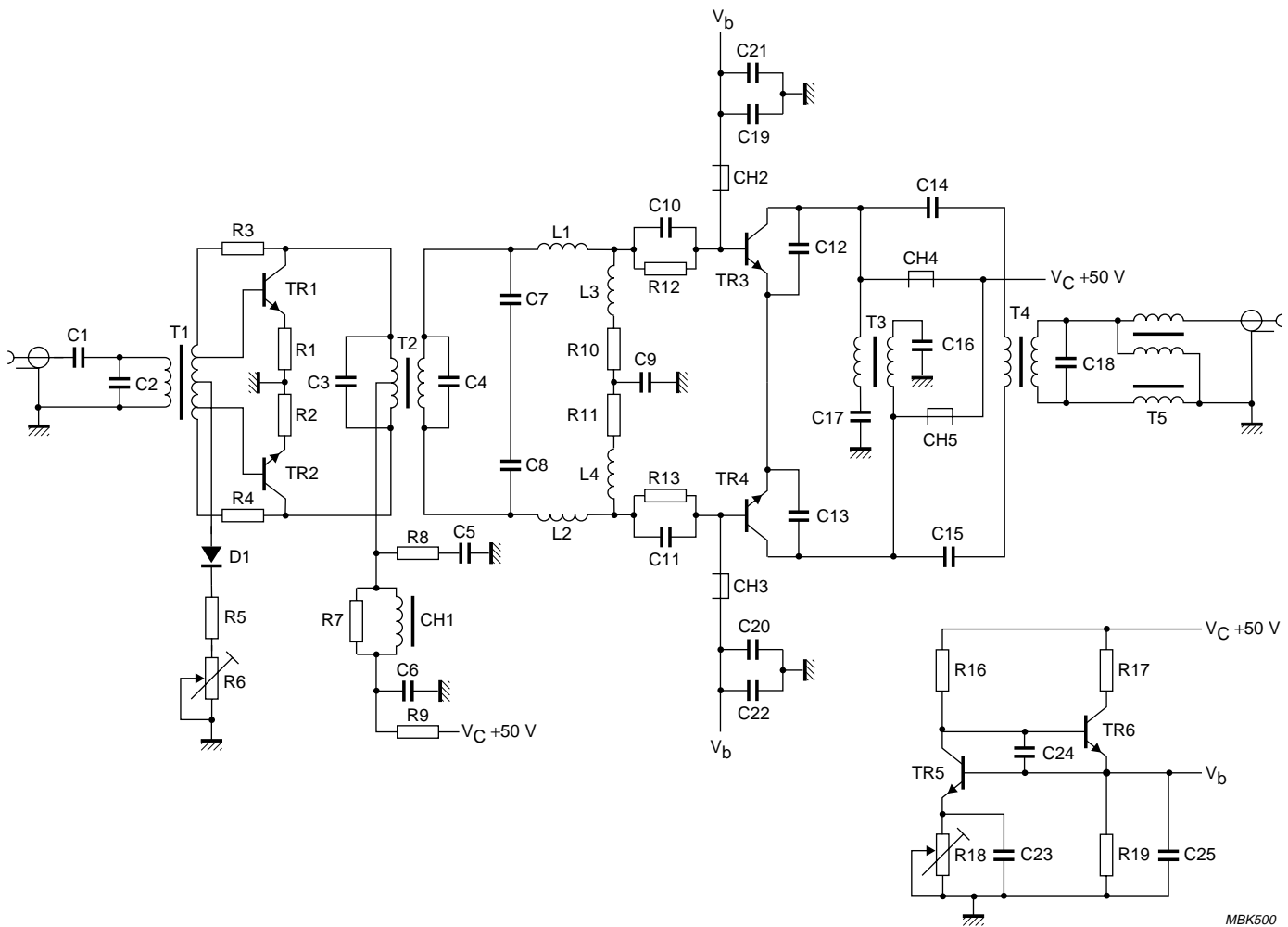

L1, L2 = 1 turn 1.3 mm Cu wire 5 mm dia.  
L3, L4 = 1 turn 1.3 mm Cu wire 7.5 mm dia.

Fig.12 Circuit diagram of the complete amplifier.

MBK500



## Two-stage wideband HF linear amplifier for 400 W PEP using BLW96 and BLW50F

Application note  
AN98030

**Table 5** Parts list for Fig.12

<b>Resistors</b>			
R1, R2	5 × 12 Ω, in parallel	CR25, ±5%	2322 211 13129
R3, R4	2 × 200 Ω, in series	PR52, ±5%,	2322 192 32001
R5	15 Ω	CR25, ±5%	2322 211 13159
R6 = R18	3.3 Ω, adjustable	TPW22	2322 011 02338
R7 = R14 = R15	22 Ω	CR25, ±5%	2322 211 13229
R8	6.8 Ω	CR25, ±5%	2322 211 13688
R9	1.8 Ω	AC10, ±10%	2322 329 10188
R10 = R11	18 Ω	PR37, ±5%	2322 212 31209
R12 = R13	2 × 12 Ω, in parallel	PR37, ±5%	2322 212 31209
	2 × 15 Ω, in parallel		2322 212 31509
R16	1.5 kΩ	PR37, ±5%	2322 212 31502
R17	3 × 180 Ω, in parallel	EH15, ±5%	2322 330 03181
R19	22 Ω	CR37, ±5%	2322 212 13229
<b>Capacitors</b>			
C1 = C23 = C24	10 nF	polyester, ±20%	2222 352 44103
C2	39 pF	ceramic, ±2%	2222 632 10399
C3	27 pF	ceramic, ±2%	2222 632 10279
C4	680 pF	polystyrene, ±2%	2222 426 6801
C5	22 nF	polyester, ±20%	2222 352 44223
C6	2 × 47nF, in parallel	polyester, ±20%	2222 352 42473
C7 = C8	2 × 470 pF, in parallel	polyester, ±2%	2222 426 4701
	1 × 390 pF, in parallel	polyester, ±2%	2222 426 3901
C9 = C10	2 × 1000 pF, in parallel	polyester, ±2%	2222 426 1002
	1 × 820 pF, in parallel	polyester, ±2%	2222 426 8201
C11	100 nF	polyester, ±20%	2222 352 44104
C12 = C13	2 × 47 pF, in parallel	ceramic, ±2%	2222 632 34479
	2 × 56 pF, in parallel	ceramic, ±2%	2222 632 34569
C14 = C15	5 × 10 nF, in parallel	polyester, ±20%	2222 352 44103
C16 = C17	3 × 100 nF, in parallel	polyester, ±20%	2222 352 54104
C18	60 pF	trimmer	2222 809 08003
C19 = C20	3.3 μF	polyester, ±10%	2222 344 21335
C21 = C22	220 μF	4 V, electrolytic	2222 016 2221
C25	220 μF	10 V, electrolytic	2222 016 4221
<b>Inductors</b>			
Ch1 = Ch2 = Ch3	2.5 turns through 6 hole ferrite bead grade 3B		4312 020 31500
Ch4 = Ch5	3 parallel loops through 6 hole ferrite bead grade 3B		4312 020 31500
L1 = L2	13.9 nH; see diagram on Fig.12		
L3 = L4	21 nH; see diagram on Fig.12		

# Two-stage wideband HF linear amplifier for 400 W PEP using BLW96 and BLW50F

## Application note AN98030

Transformers	
T1	<p>1:1.5 turns ratio, wound on twin hole bead Philips grade 4B1 (4312 020 31525).            Primary: 4 turns of <math>2 \times 0.45</math> mm enamelled Cu wire in parallel.            Secondary: 6 turns of <math>2 \times 0.45</math> mm enamelled Cu wire in parallel tapped at centre and at <math>2 \times 1</math> turns from centre. See Fig.13.            Typical primary reactance at <math>f = 1.6</math> MHz = (secondary o/c) = <math>j160</math>, typical leakage reactance at <math>f = 30</math> MHz = (secondary s/c) = <math>j25</math>.</p>
T2	<p>4.5 : 1 turns ratio. Consists of two transformers with primary and secondary windings connected in parallel, each wound on twin hole bead Philips grade 4B1 (4312 020 31500).            Primary winding 9 turns 0.45 mm enamelled Cu wire centre tapped.            Secondary 2 turns of <math>2 \times 0.45</math> mm enamelled Cu wire in parallel.            Typical primary reactance of combination at <math>f = 1.6</math> MHz (secondary o/c) = <math>j400</math>.            Typical leakage reactance of combination at <math>f = 30</math> MHz (secondary s/c) = <math>j90</math>.</p>
T3	<p>The centre tapped choke, wound on a 50 mm length of 4A10 aerial rod (or equivalent), (4311 020 55390), 4 turns of twisted enamelled Cu wire 1.0 mm, typical total reactance at <math>f = 1.6</math> MHz = <math>j40</math>.</p>
T4	<p>2.33 : 1 turns ratio, consists of two transformers with primary windings and secondary windings connected in parallel, each wound on 4C6 toroids <math>36 \times 23 \times 15</math> mm (4322 020 91090).            Primary winding 6 turns of Cu tape 8 mm wide.            Secondary winding 14 turns of <math>4 \times 0.5</math> mm enamelled Cu wire in parallel.            Windings are separated by PTFE tape approximately 0.25 mm thick.            Typical primary reactance of combination at <math>f = 1.6</math> MHz (primary o/c) = <math>j200</math>.            Typical leakage reactance of combination at <math>f = 30</math> MHz (primary s/c) = <math>j50</math>.</p>
T5	<p>Output balun transformer. Wound on two 4C6 toroids <math>36 \times 23 \times 15</math> mm, (4322 020 91090), with 8 turns of <math>50 \Omega</math> coaxial cable having PTFE insulation and approximately 4 mm external diameter and 8 turns of 1 mm enamelled Cu wire for the balancing winding - see diagram</p>

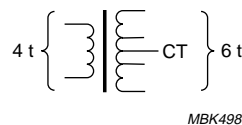

Fig.13 Transformer T<sub>1</sub>.

# Two-stage wideband HF linear amplifier for 400 W PEP using BLW96 and BLW50F

Application note  
AN98030

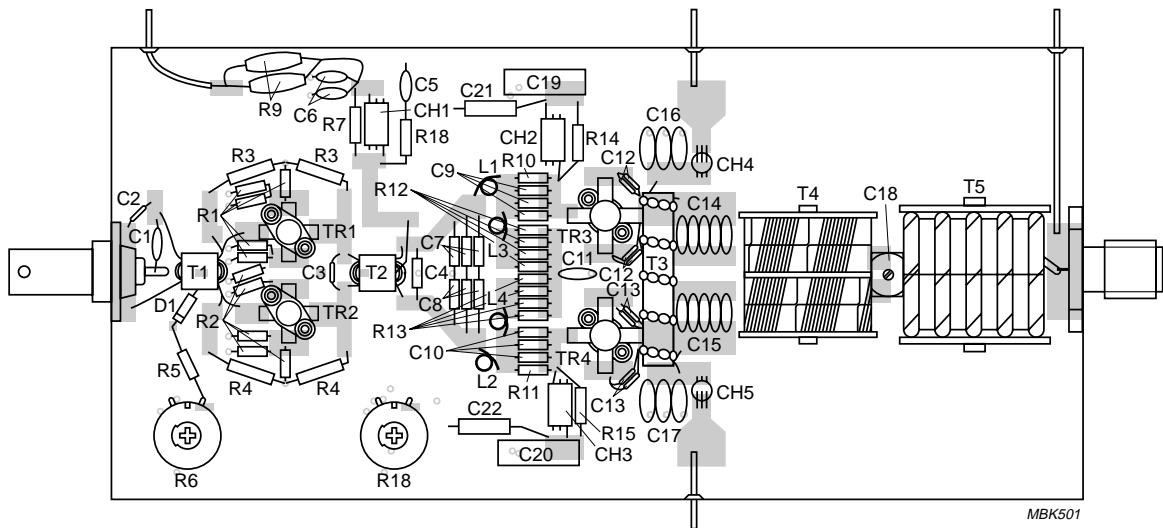
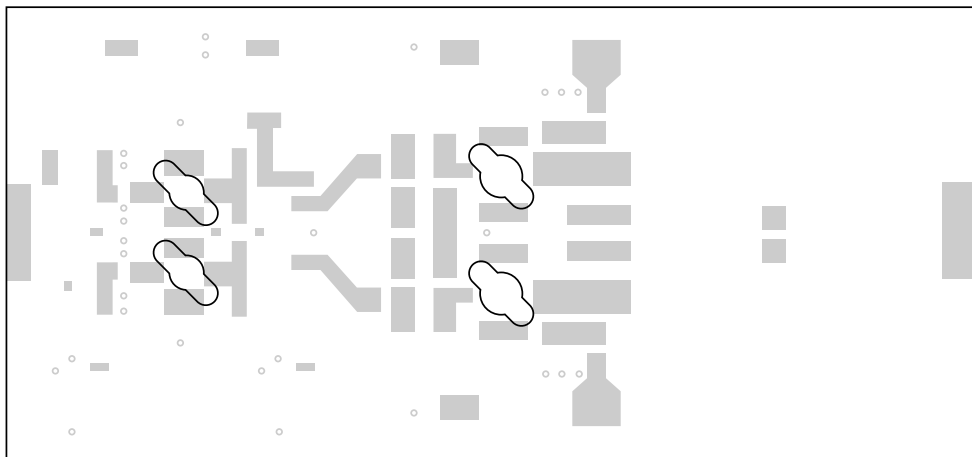

Fig.14 Printed circuit board and lay-out.

# Two-stage wideband HF linear amplifier for 400 W PEP using BLW96 and BLW50F

Application note  
AN98030

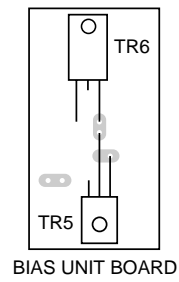
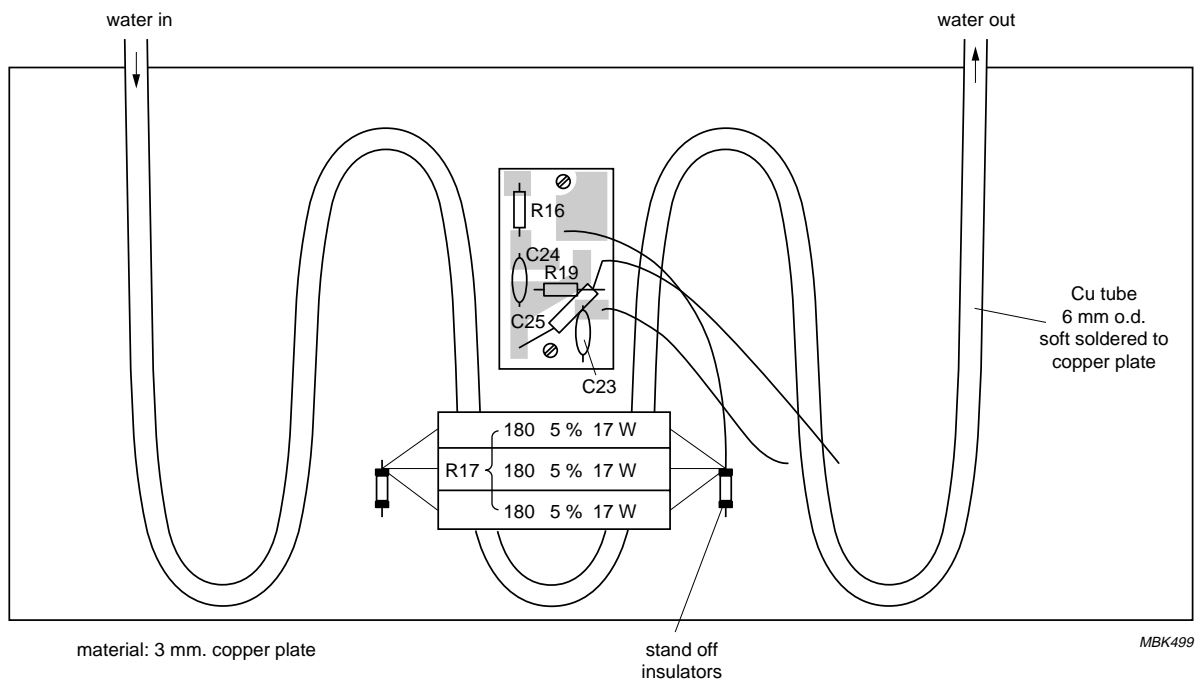

Fig.15 Water cooled heatsink.

Two-stage wideband HF linear amplifier for  
400 W PEP using BLW96 and BLW50F

Application note  
AN98030

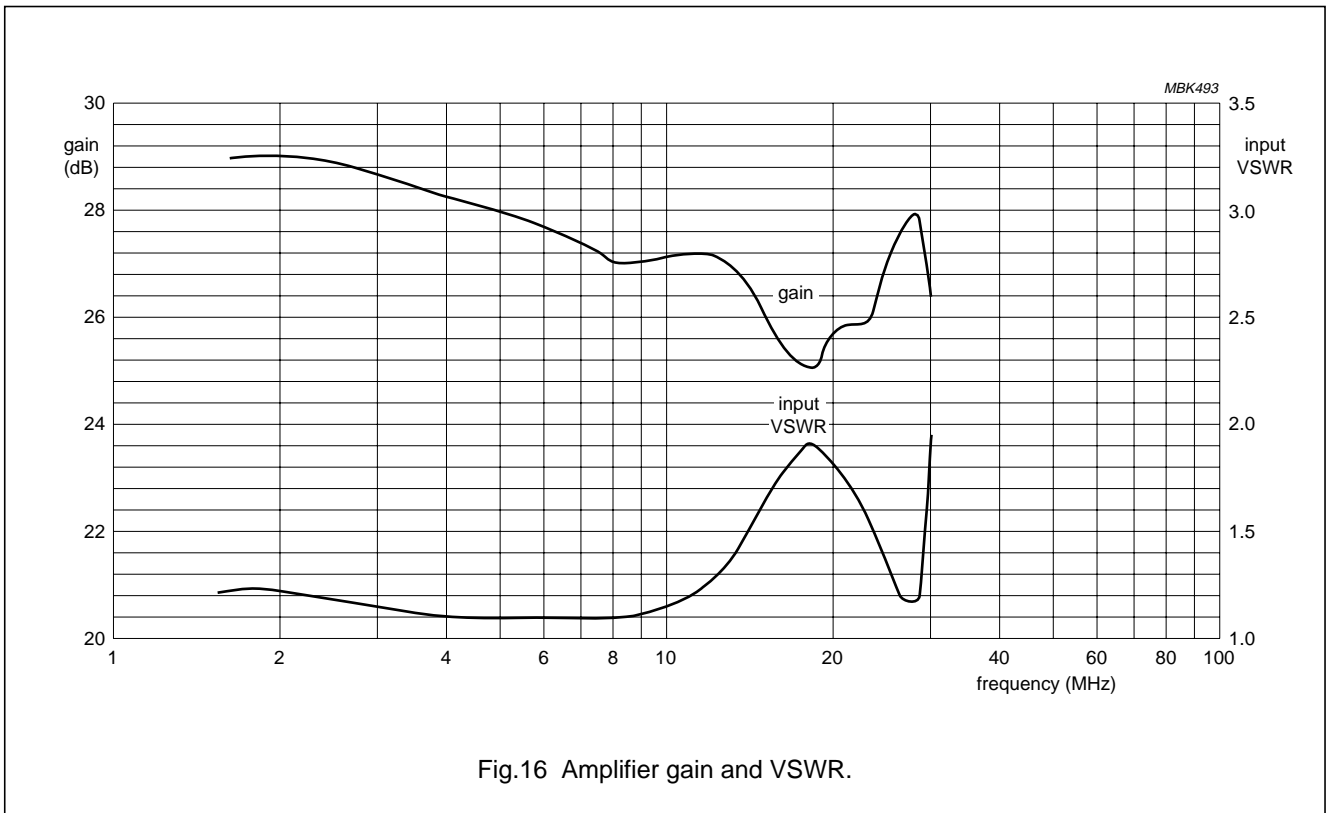

Fig.16 Amplifier gain and VSWR.

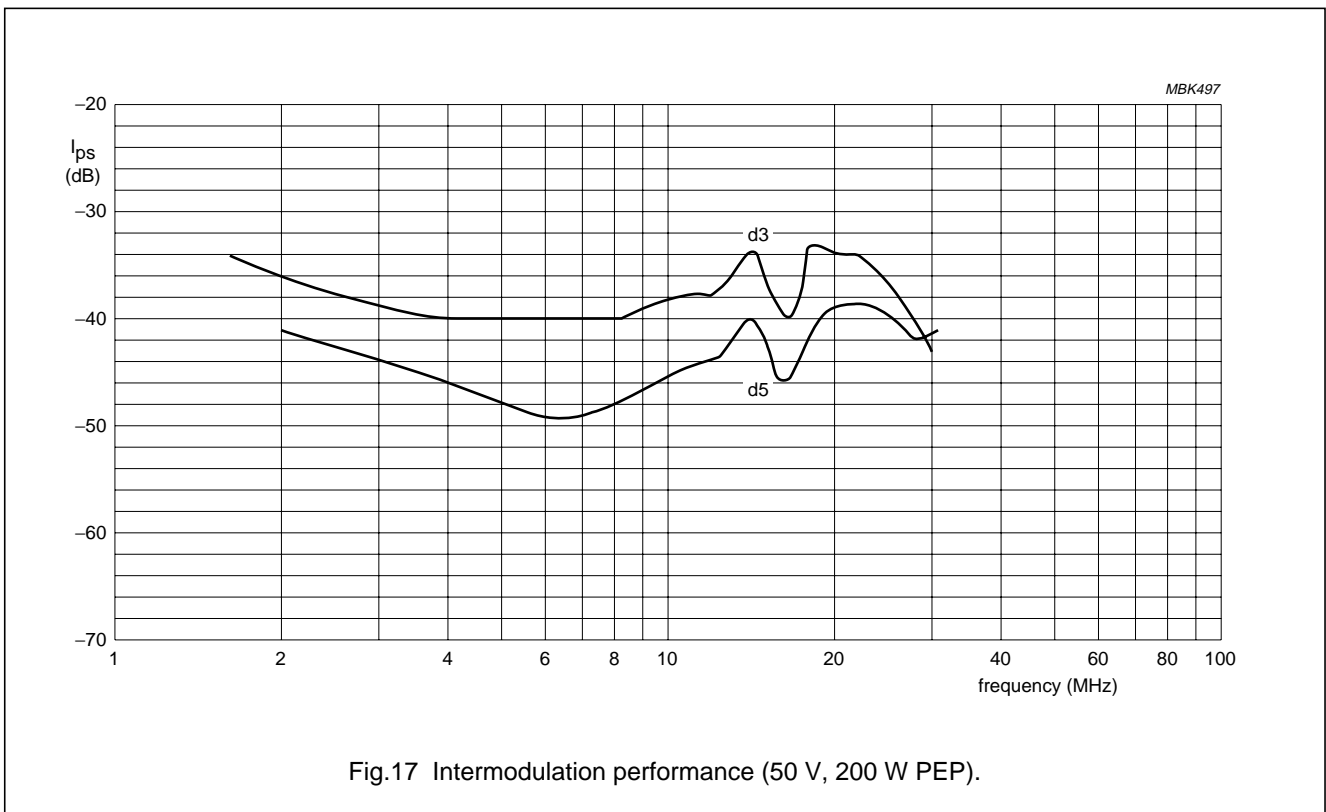

Fig.17 Intermodulation performance (50 V, 200 W PEP).

# Two-stage wideband HF linear amplifier for 400 W PEP using BLW96 and BLW50F

Application note  
AN98030

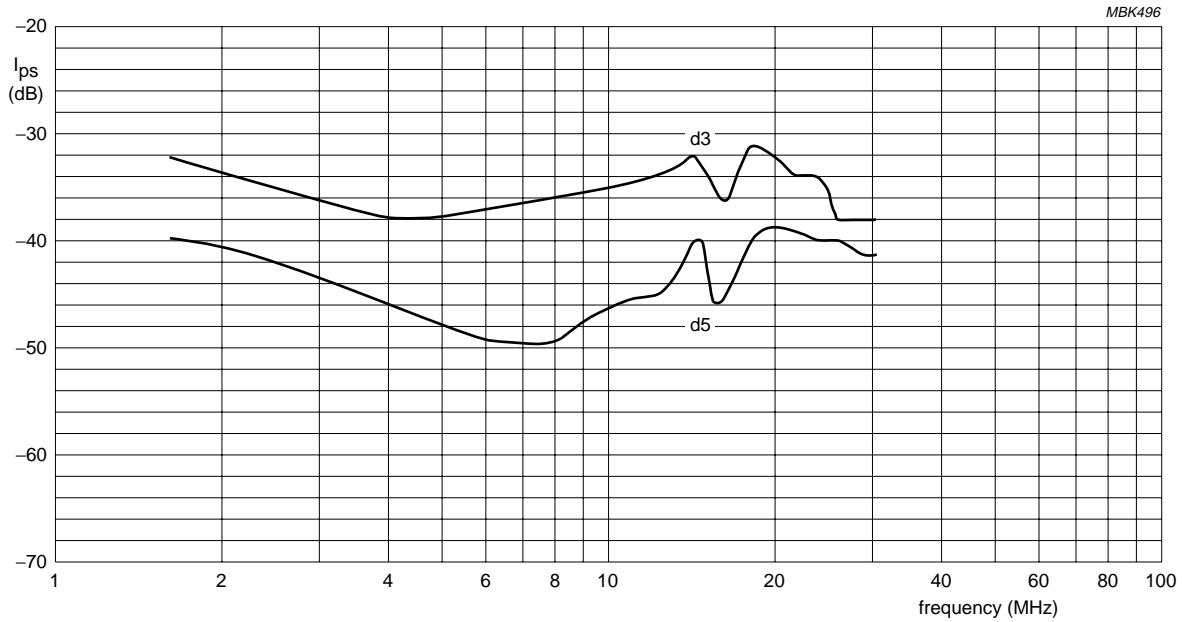

Fig.18 Intermodulation performance (50 V, 300 W PEP).

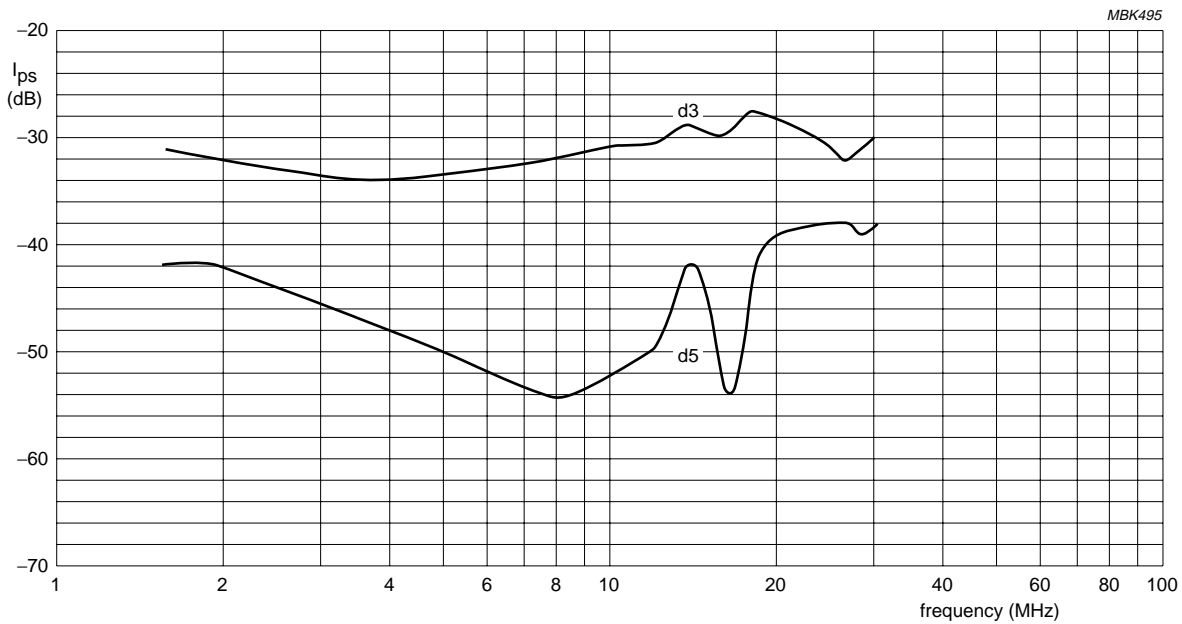

Fig.19 Intermodulation performance (50 V, 400 W PEP).

# Two-stage wideband HF linear amplifier for 400 W PEP using BLW96 and BLW50F

Application note  
AN98030

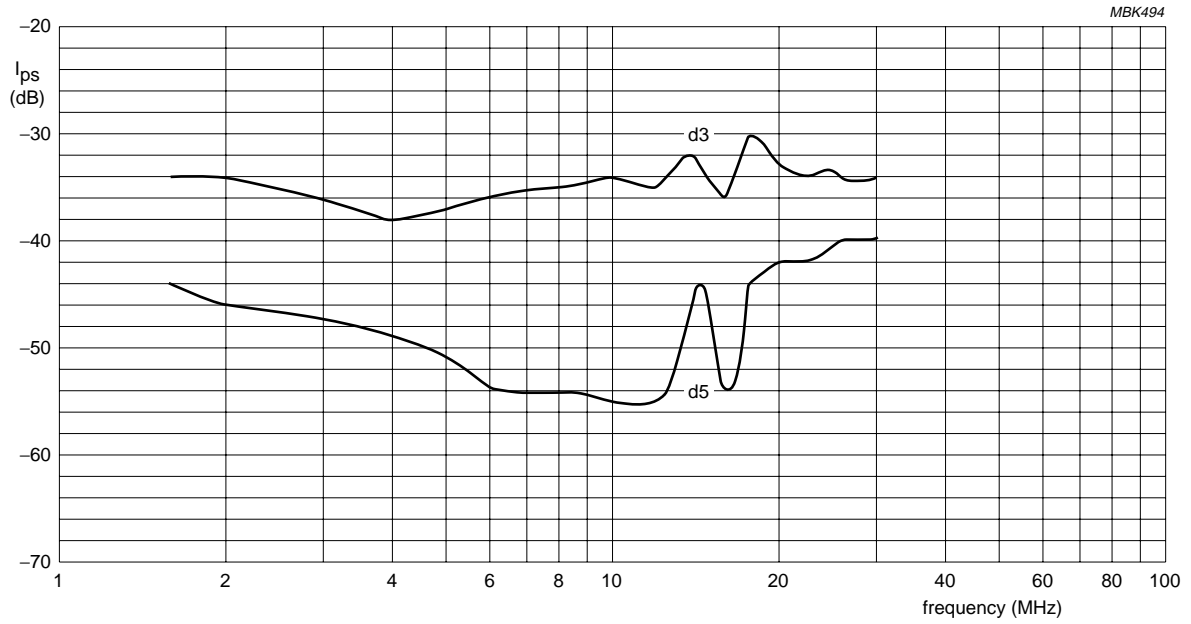

Fig.20 Intermodulation performance (45 V, 300 W PEP).

# Philips Semiconductors – a worldwide company

**Argentina:** see South America

**Australia:** 34 Waterloo Road, NORTH RYDE, NSW 2113,  
Tel. +61 2 9805 4455, Fax. +61 2 9805 4466

**Austria:** Computerstr. 6, A-1101 WIEN, P.O. Box 213, Tel. +43 160 1010,  
Fax. +43 160 101 1210

**Belarus:** Hotel Minsk Business Center, Bld. 3, r. 1211, Volodarski Str. 6,  
220050 MINSK, Tel. +375 172 200 733, Fax. +375 172 200 773

**Belgium:** see The Netherlands

**Brazil:** see South America

**Bulgaria:** Philips Bulgaria Ltd., Energoproject, 15th floor,  
51 James Bourchier Blvd., 1407 SOFIA,  
Tel. +359 2 689 211, Fax. +359 2 689 102

**Canada:** PHILIPS SEMICONDUCTORS/COMPONENTS,  
Tel. +1 800 234 7381

**China/Hong Kong:** 501 Hong Kong Industrial Technology Centre,  
72 Tat Chee Avenue, Kowloon Tong, HONG KONG,  
Tel. +852 2319 7888, Fax. +852 2319 7700

**Colombia:** see South America

**Czech Republic:** see Austria

**Denmark:** Prags Boulevard 80, PB 1919, DK-2300 COPENHAGEN S,  
Tel. +45 32 88 2636, Fax. +45 31 57 0044

**Finland:** Sinikalliontie 3, FIN-02630 ESPOO,  
Tel. +358 9 615800, Fax. +358 9 61580920

**France:** 51 Rue Carnot, BP317, 92156 SURESNES Cedex,  
Tel. +33 1 40 99 6161, Fax. +33 1 40 99 6427

**Germany:** Hammerbrookstraße 69, D-20097 HAMBURG,  
Tel. +49 40 23 53 60, Fax. +49 40 23 536 300

**Greece:** No. 15, 25th March Street, GR 17778 TAVROS/ATHENS,  
Tel. +30 1 4894 339/239, Fax. +30 1 4814 240

**Hungary:** see Austria

**India:** Philips INDIA Ltd, Band Box Building, 2nd floor,  
254-D, Dr. Annie Besant Road, Worli, MUMBAI 400 025,  
Tel. +91 22 493 8541, Fax. +91 22 493 0966

**Indonesia:** see Singapore

**Ireland:** Newstead, Clonskeagh, DUBLIN 14,  
Tel. +353 1 7640 000, Fax. +353 1 7640 200

**Israel:** RAPAC Electronics, 7 Kehilat Saloniki St, PO Box 18053,  
TEL AVIV 61180, Tel. +972 3 645 0444, Fax. +972 3 649 1007

**Italy:** PHILIPS SEMICONDUCTORS, Piazza IV Novembre 3,  
20124 MILANO, Tel. +39 2 6752 2531, Fax. +39 2 6752 2557

**Japan:** Philips Bldg 13-37, Kohnan 2-chome, Minato-ku, TOKYO 108,  
Tel. +81 3 3740 5130, Fax. +81 3 3740 5077

**Korea:** Philips House, 260-199 Itaewon-dong, Yongsan-ku, SEOUL,  
Tel. +82 2 709 1412, Fax. +82 2 709 1415

**Malaysia:** No. 76 Jalan Universiti, 46200 PETALING JAYA, SELANGOR,  
Tel. +60 3 750 5214, Fax. +60 3 757 4880

**Mexico:** 5900 Gateway East, Suite 200, EL PASO, TEXAS 79905,  
Tel. +9-5 800 234 7381

**Middle East:** see Italy

**Netherlands:** Postbus 90050, 5600 PB EINDHOVEN, Bldg. VB,  
Tel. +31 40 27 82785, Fax. +31 40 27 88399

**New Zealand:** 2 Wagener Place, C.P.O. Box 1041, AUCKLAND,  
Tel. +64 9 849 4160, Fax. +64 9 849 7811

**Norway:** Box 1, Manglerud 0612, OSLO,  
Tel. +47 22 74 8000, Fax. +47 22 74 8341

**Philippines:** Philips Semiconductors Philippines Inc.,  
106 Valero St. Salcedo Village, P.O. Box 2108 MCC, MAKATI,  
Metro MANILA, Tel. +63 2 816 6380, Fax. +63 2 817 3474

**Poland:** Ul. Lukiska 10, PL 04-123 WARSZAWA,  
Tel. +48 22 612 2831, Fax. +48 22 612 2327

**Portugal:** see Spain

**Romania:** see Italy

**Russia:** Philips Russia, Ul. Usatcheva 35A, 119048 MOSCOW,  
Tel. +7 095 755 6918, Fax. +7 095 755 6919

**Singapore:** Lorong 1, Toa Payoh, SINGAPORE 1231,  
Tel. +65 350 2538, Fax. +65 251 6500

**Slovakia:** see Austria

**Slovenia:** see Italy

**South Africa:** S.A. PHILIPS Pty Ltd., 195-215 Main Road Martindale,  
2092 JOHANNESBURG, P.O. Box 7430 Johannesburg 2000,  
Tel. +27 11 470 5911, Fax. +27 11 470 5494

**South America:** Al. Vicente Pinzon, 173, 6th floor,  
04547-130 SÃO PAULO, SP, Brazil,  
Tel. +55 11 821 2333, Fax. +55 11 821 2382

**Spain:** Balmes 22, 08007 BARCELONA,  
Tel. +34 3 301 6312, Fax. +34 3 301 4107

**Sweden:** Kottbygatan 7, Akalla, S-16485 STOCKHOLM,  
Tel. +46 8 632 2000, Fax. +46 8 632 2745

**Switzerland:** Allmendstrasse 140, CH-8027 ZÜRICH,  
Tel. +41 1 488 2686, Fax. +41 1 488 3263

**Taiwan:** Philips Semiconductors, 6F, No. 96, Chien Kuo N. Rd., Sec. 1,  
TAIPEI, Taiwan Tel. +886 2 2134 2865, Fax. +886 2 2134 2874

**Thailand:** PHILIPS ELECTRONICS (THAILAND) Ltd.,  
209/2 Sanpavuth-Bangna Road Prakanong, BANGKOK 10260,  
Tel. +66 2 745 4090, Fax. +66 2 398 0793

**Turkey:** Talatpasa Cad. No. 5, 80640 GÜLTEPE/ISTANBUL,  
Tel. +90 212 279 2770, Fax. +90 212 282 6707

**Ukraine:** PHILIPS UKRAINE, 4 Patrice Lumumba str., Building B, Floor 7,  
252042 KIEV, Tel. +380 44 264 2776, Fax. +380 44 268 0461

**United Kingdom:** Philips Semiconductors Ltd., 276 Bath Road, Hayes,  
MIDDLESEX UB3 5BX, Tel. +44 181 730 5000, Fax. +44 181 754 8421

**United States:** 811 East Arques Avenue, SUNNYVALE, CA 94088-3409,  
Tel. +1 800 234 7381

**Uruguay:** see South America

**Vietnam:** see Singapore

**Yugoslavia:** PHILIPS, Trg N. Pasica 5/v, 11000 BEOGRAD,  
Tel. +381 11 625 344, Fax. +381 11 635 777

**For all other countries apply to:** Philips Semiconductors,  
International Marketing & Sales Communications, Building BE-p, P.O. Box 218,  
5600 MD EINDHOVEN, The Netherlands, Fax. +31 40 27 24825

**Internet:** <http://www.semiconductors.philips.com>

© Philips Electronics N.V. 1998

SCA57

All rights are reserved. Reproduction in whole or in part is prohibited without the prior written consent of the copyright owner.

The information presented in this document does not form part of any quotation or contract, is believed to be accurate and reliable and may be changed without notice. No liability will be accepted by the publisher for any consequence of its use. Publication thereof does not convey nor imply any license under patent- or other industrial or intellectual property rights.

Printed in The Netherlands

Date of release: 1998 Mar 23

*Let's make things better.*

**Philips  
Semiconductors**



**PHILIPS**



SUNSTAR 商斯达实业集团是集研发、生产、工程、销售、代理经销、技术咨询、信息服务等为一体的高科技企业，是专业高科技电子产品生产厂家，是具有 10 多年历史的专业电子元器件供应商，是中国最早和最大的仓储式连锁规模经营大型综合电子零部件代理分销商之一，是一家专业代理和分销世界各大品牌 IC 芯片和电子元器件的连锁经营综合性国际公司，专业经营进口、国产名厂名牌电子元件，型号、种类齐全。在香港、北京、深圳、上海、西安、成都等全国主要电子市场设有直属分公司和产品展示展销窗口门市部专卖店及代理分销商，已在全国范围内建成强大统一的供货和代理分销网络。我们专业代理经销、开发生产电子元器件、集成电路、传感器、微波光电元器件、工控机/DOC/DOM 电子盘、专用电路、单片机开发、MCU/DSP/ARM/FPGA 软件硬件、二极管、三极管、模块等，是您可靠的一站式现货配套供应商、方案提供商、部件功能模块开发配套商。商斯达实业公司拥有庞大的资料库，有数位毕业于著名高校——有中国电子工业摇篮之称的西安电子科技大学（西军电）并长期从事国防尖端科技研究的高级工程师为您精挑细选、量身订做各种高科技电子元器件，并解决各种技术问题。

微波光电部专业代理经销高频、微波、光纤、光电元器件、组件、部件、模块、整机；电磁兼容元器件、材料、设备；微波 CAD、EDA 软件、开发测试仿真工具；微波、光纤仪器仪表。欢迎国外高科技微波、光纤厂商将优秀产品介绍到中国、共同开拓市场。长期大量现货专业批发高频、微波、卫星、光纤、电视、CATV 器件：晶振、VCO、连接器、PIN 开关、变容二极管、开关二极管、低噪晶体管、功率电阻及电容、放大器、功率管、MMIC、混频器、耦合器、功分器、振荡器、合成器、衰减器、滤波器、隔离器、环行器、移相器、调制解调器；光电子元件和组件：红外发射管、红外接收管、光电开关、光敏管、发光二极管和发光二极管组件、半导体激光二极管和激光器组件、光电探测器和光接收组件、光发射接收模块、光纤激光器和光放大器、光调制器、光开关、DWDM 用光发射和接收器件、用户接入系统光收发器件与模块、光纤连接器、光纤跳线/尾纤、光衰减器、光纤适配器、光隔离器、光耦合器、光环行器、光复用器/转换器；无线收发芯片和模组、蓝牙芯片和模组。

更多产品请看本公司产品专用销售网站：

商斯达中国传感器科技信息网：<http://www.sensor-ic.com/>

商斯达工控安防网：<http://www.pc-ps.net/>

商斯达电子元器件网：<http://www.sunstare.com/>

商斯达微波光电产品网：[HTTP://www.rfoe.net/](http://www.rfoe.net/)

商斯达消费电子产品网：<http://www.icasic.com/>

商斯达实业科技产品网：<http://www.sunstars.cn/> 微波元器件销售热线：

地址：深圳市福田区福华路福庆街鸿图大厦 1602 室

电话：0755-82884100 83397033 83396822 83398585

传真：0755-83376182 (0) 13823648918 MSN: SUNS8888@hotmail.com

邮编：518033 E-mail:[szss20@163.com](mailto:szss20@163.com) QQ: 195847376

深圳赛格展销部：深圳华强北路赛格电子市场 2583 号 电话：0755-83665529 25059422

技术支持：0755-83394033 13501568376

欢迎索取免费详细资料、设计指南和光盘；产品凡多，未能尽录，欢迎来电查询。

北京分公司：北京海淀区知春路 132 号中发电子大厦 3097 号

TEL: 010-81159046 82615020 13501189838 FAX: 010-62543996

上海分公司：上海市北京东路 668 号上海赛格电子市场 D125 号

TEL: 021-28311762 56703037 13701955389 FAX: 021-56703037

西安分公司：西安高新开发区 20 所(中国电子科技集团导航技术研究所)

西安劳动南路 88 号电子商城二楼 D23 号

TEL: 029-81022619 13072977981 FAX:029-88789382